



US00D735123S

(12) **United States Design Patent**
Iwabuchi

(10) **Patent No.:** **US D735,123 S**
(45) **Date of Patent:** **** Jul. 28, 2015**

(54) **SIDEWALL PORTION OF AN AUTOMOBILE TIRE**

(71) Applicant: **BRIDGESTONE CORPORATION**,
Chou-ku (JP)

(72) Inventor: **Sotaro Iwabuchi**, Chuo-ku (JP)

(73) Assignee: **BRIDGESTONE CORPORATION**,
Tokyo (JP)

(**) Term: **14 Years**

(21) Appl. No.: **29/460,112**

(22) Filed: **Jul. 8, 2013**

(30) **Foreign Application Priority Data**

Jan. 10, 2013 (JP) 2013-000284
Jan. 10, 2013 (JP) 2013-000285

(51) **LOC (10) Cl.** **12-15**

(52) **U.S. Cl.**
USPC **D12/605**

(58) **Field of Classification Search**
USPC D12/605; 152/209.1–209.28, 455
CPC B60C 1/00
See application file for complete search history.

(56) **References Cited**

U.S. PATENT DOCUMENTS

D477,810 S 7/2003 Budich et al.
D579,867 S 11/2008 Behr et al.

(Continued)

FOREIGN PATENT DOCUMENTS

JP 1257249 S 12/2005
JP 1367780 S 8/2009

(Continued)

OTHER PUBLICATIONS

OHIM Publication No. 000671292-0001 (Mar. 13, 2007). (JPO Design Division Prior Art Ref. No. HH19202374).

(Continued)

Primary Examiner — George D Kirschbaum

(74) *Attorney, Agent, or Firm* — Sughrue Mion, PLLC

(57) **CLAIM**

The ornamental design for a sidewall portion of an automobile tire, as shown and described.

DESCRIPTION

The patent or application file contains at least one drawing executed in color. Copies of this patent or patent application publication with color drawing(s) will be provided by the Office upon request and payment of the necessary Fee.

FIG. 1 is a perspective view of sidewall portion of an automobile tire according to a first embodiment of my new design;

FIG. 2 is a front view thereof;

FIG. 3 is a top view thereof;

FIG. 4 is a right side view thereof;

FIG. 5 is a left side of view thereof;

FIG. 6 is a rear view thereof;

FIG. 7 is a bottom view thereof;

FIG. 8 is a fragmentary enlarged view showing the details of the sidewall portion defined by cross-section by lines A-A and B-B in FIG. 2;

FIG. 9 is a section view taken along line 9-9 in FIG. 8;

FIG. 10 is a perspective view of sidewall portion of an automobile tire according to a second embodiment of my new design;

FIG. 11 is a front view thereof;

FIG. 12 is a top view thereof;

FIG. 13 is a right side view thereof;

FIG. 14 is a left side of view thereof;

FIG. 15 is a rear view thereof;

FIG. 16 is a bottom view thereof;

FIG. 17 is a fragmentary enlarged view showing the details of the sidewall portion defined by cross-section by lines A-A and B-B in FIG. 11; and,

FIG. 18 is a section view taken along line 18-18 in FIG. 17.

Only the green color (and no other colors) in FIGS. 10-14, 16 and 17 is being claimed.

The broken lines are used to show portions of the tire that are not being claimed, and thus form no part of the claimed design.

1 Claim, 18 Drawing Sheets
(7 of 18 Drawing Sheet(s) Filed in Color)

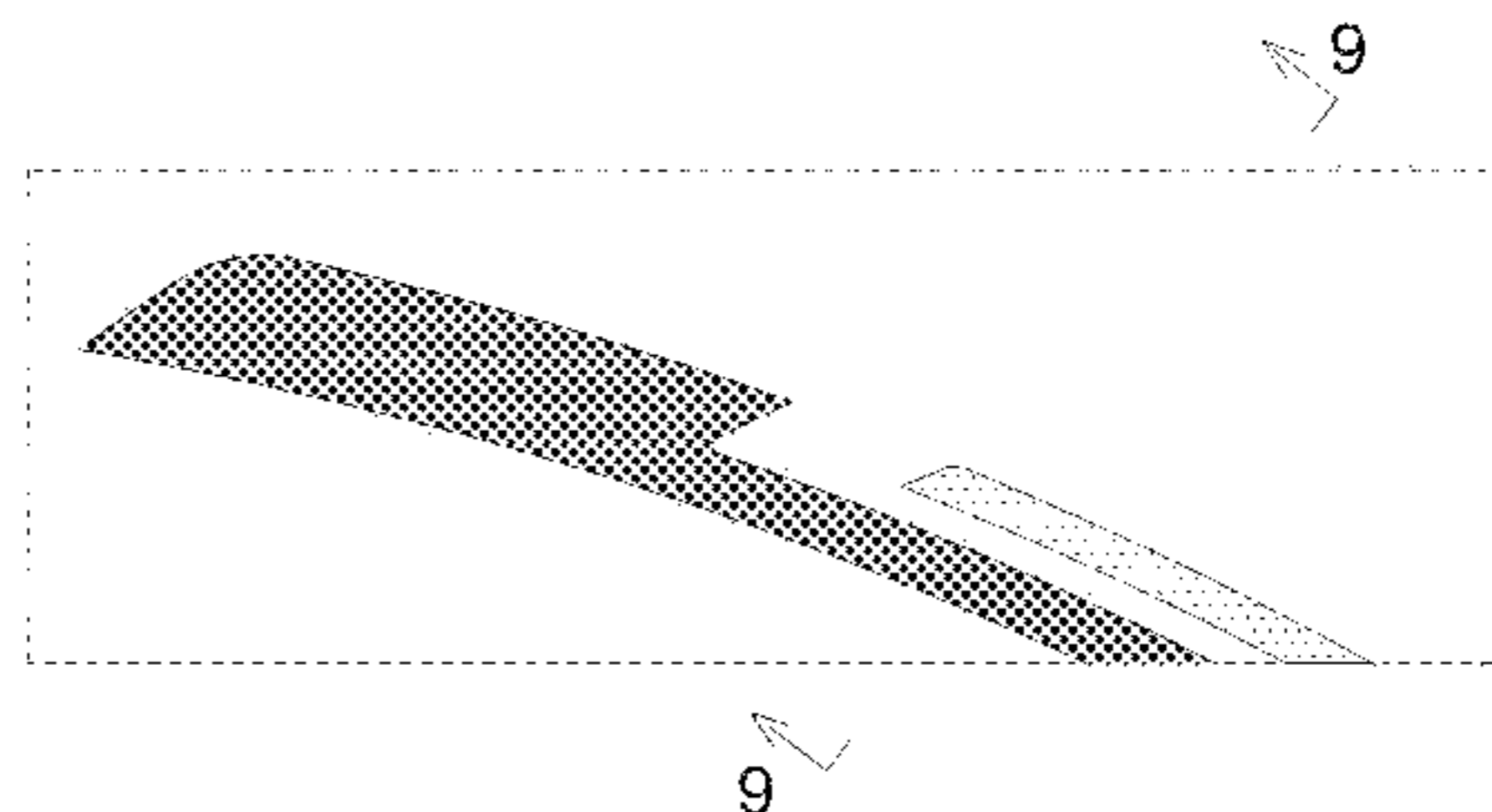
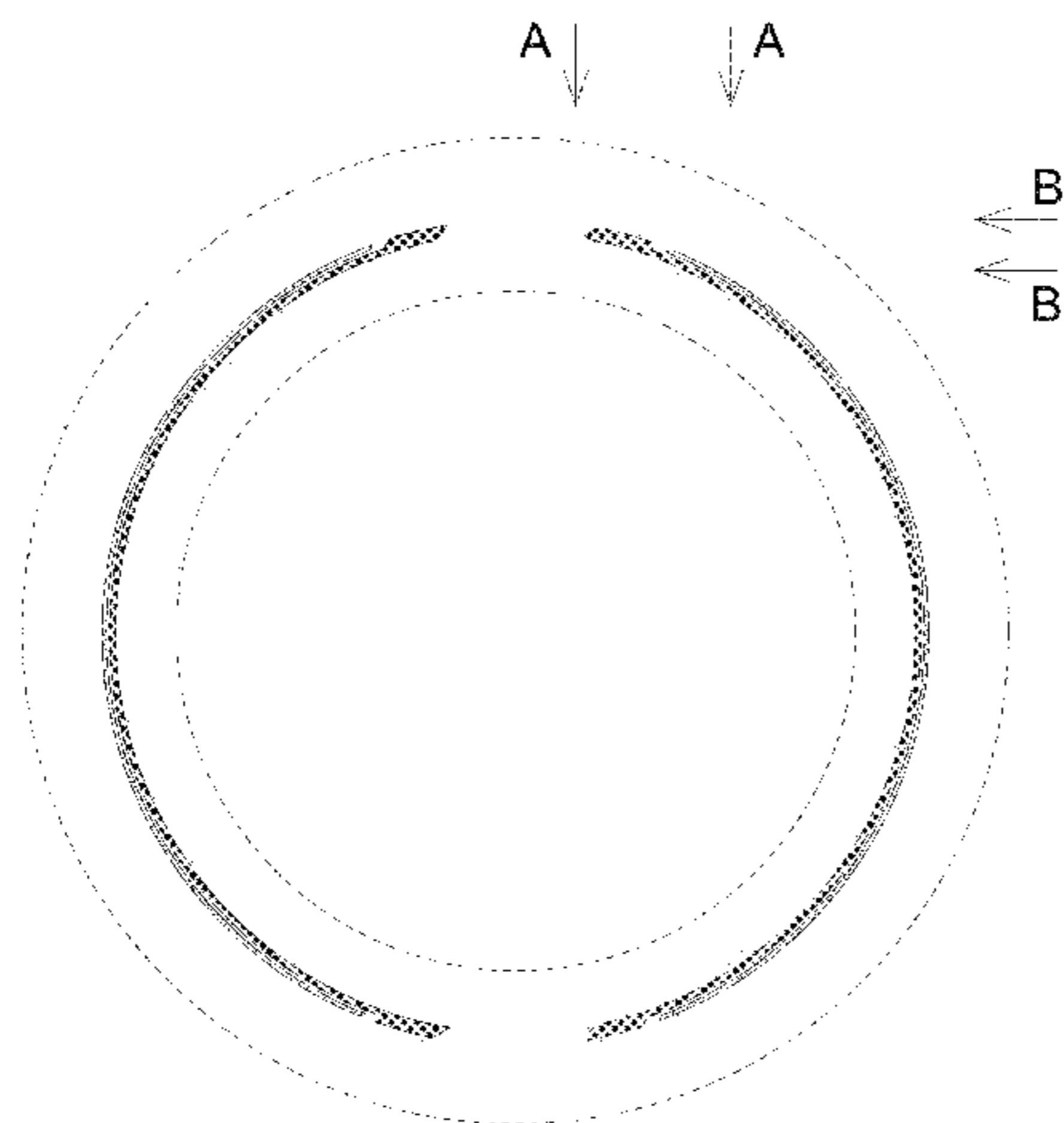

(56)

References Cited

U.S. PATENT DOCUMENTS

D662,871 S * 7/2012 Miyazaki D12/517
D708,121 S * 7/2014 Iwabuchi D12/605

FOREIGN PATENT DOCUMENTS

JP 1444646 S 6/2012
JP 1444653 S 6/2012
JP 1453189 S 10/2012
JP 1458267 S 12/2012
JP 1466304 S 4/2013

JP 1473737 S 7/2013
JP 1478334 S 9/2013
JP 1478558 S 9/2013

OTHER PUBLICATIONS

Goodyear Japan HP, News Release: "New Release of a dedicated radial tire for a van [Cargo Pro]" published on Jan. 27, 2012.
Japanese Design Gazette dated Sep. 2, 2013 issued in corresponding Japanese Design Application No. D2013-000284.
Japanese Design Gazette dated Sep. 2, 2013 issued in corresponding Japanese Design Application No. D2013-000285.

* cited by examiner

FIG. 1

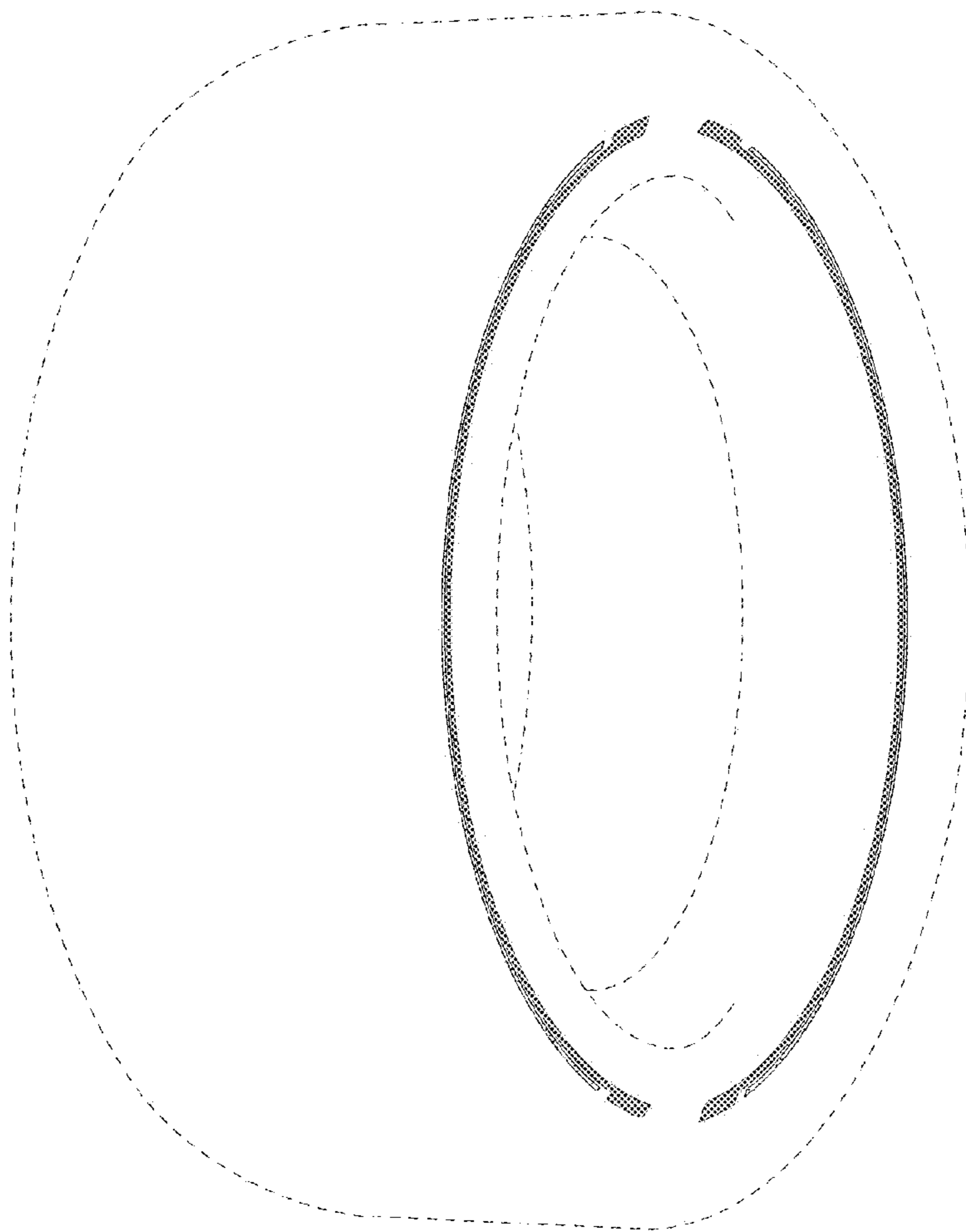

FIG. 2

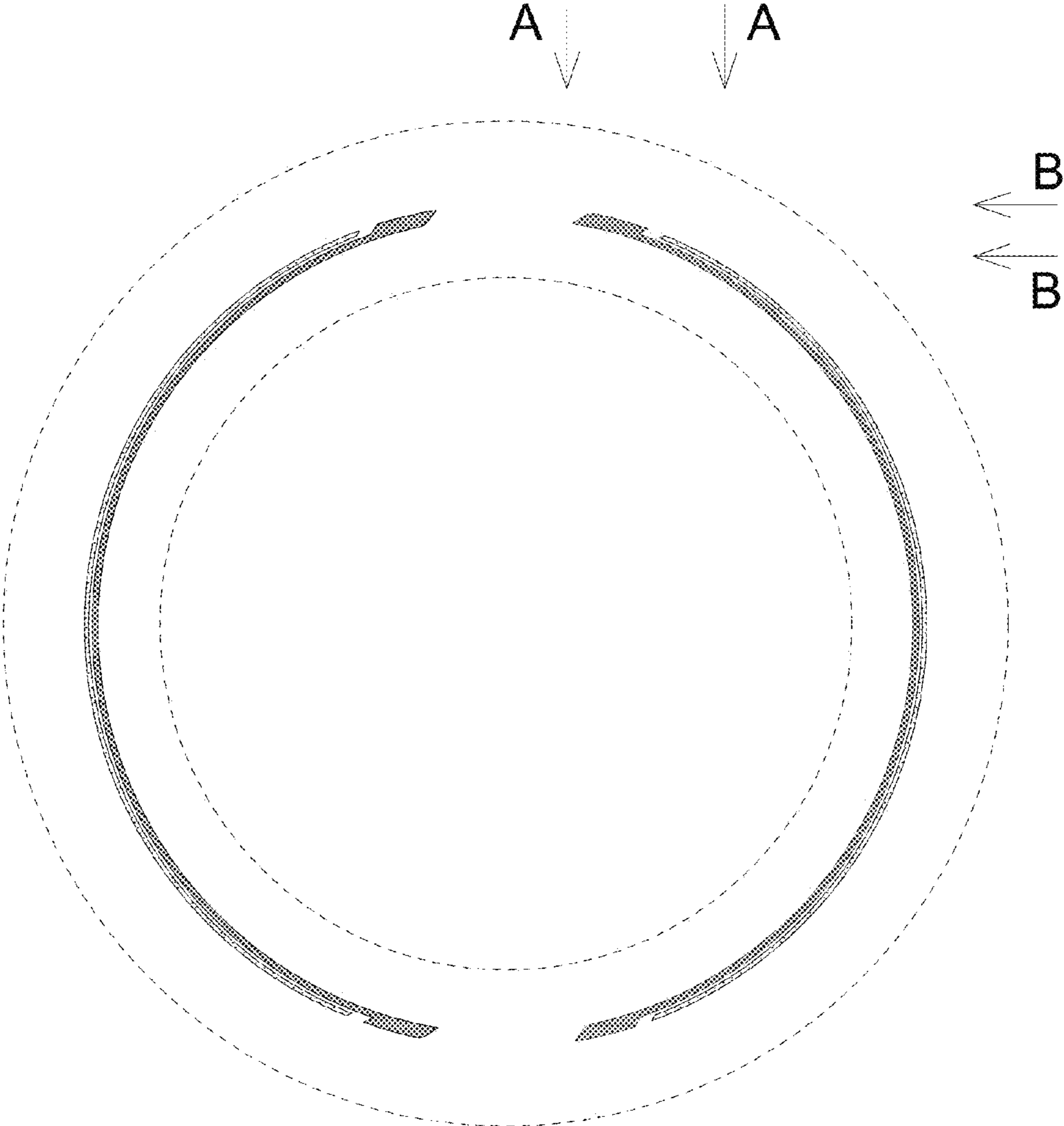

FIG. 3

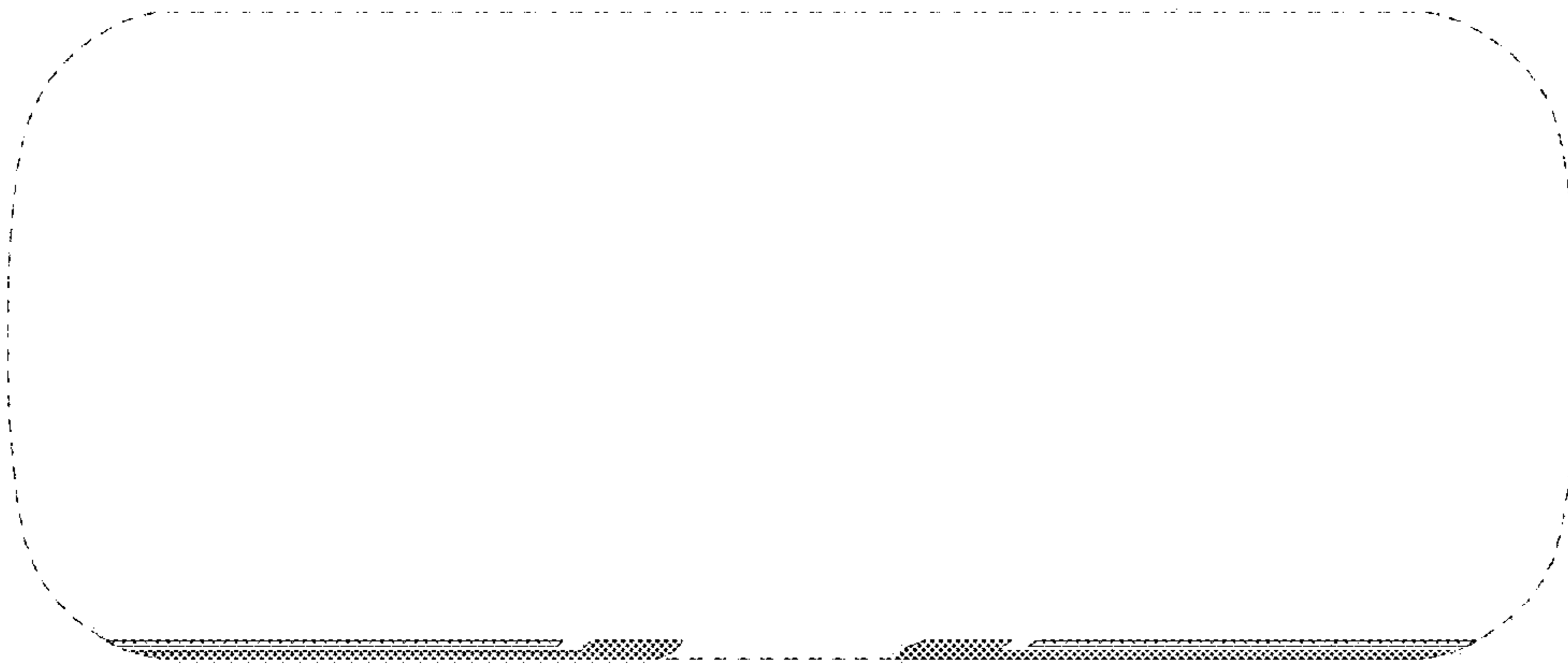

FIG. 4

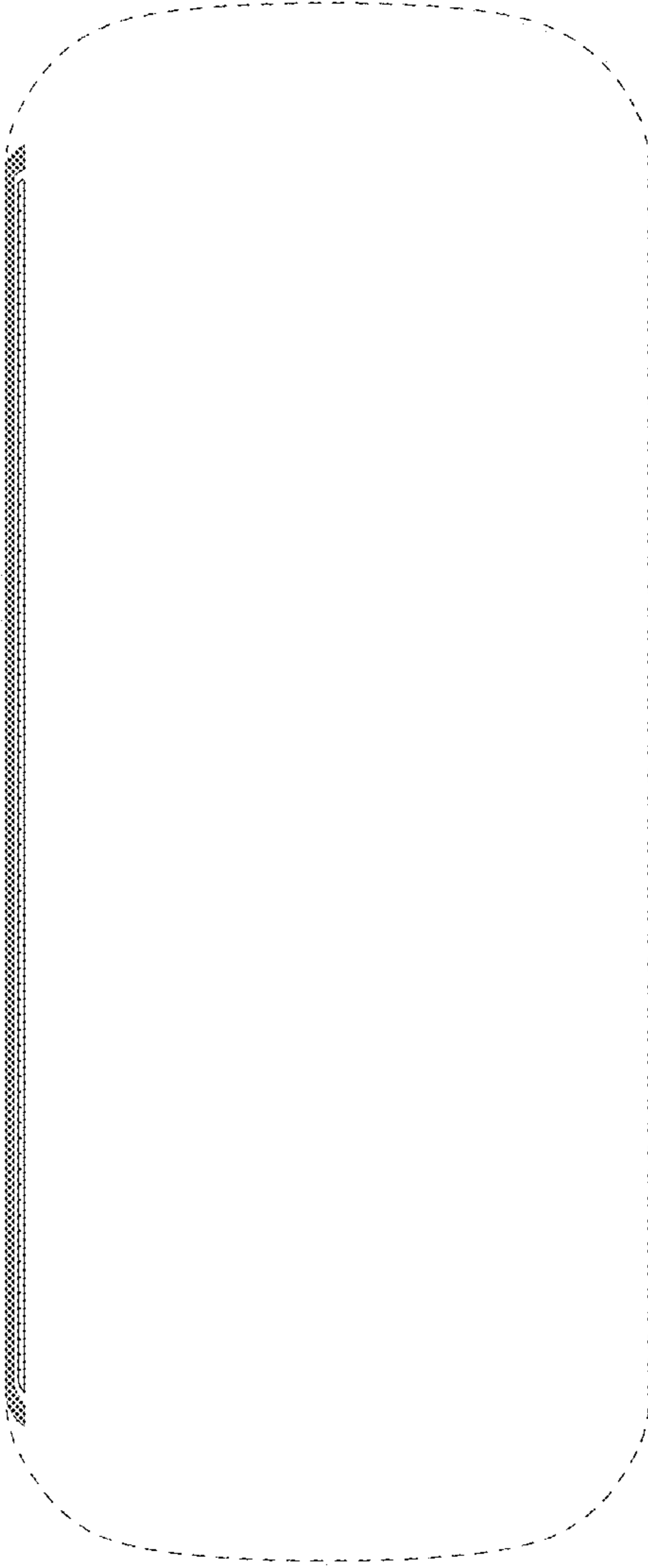

FIG. 5

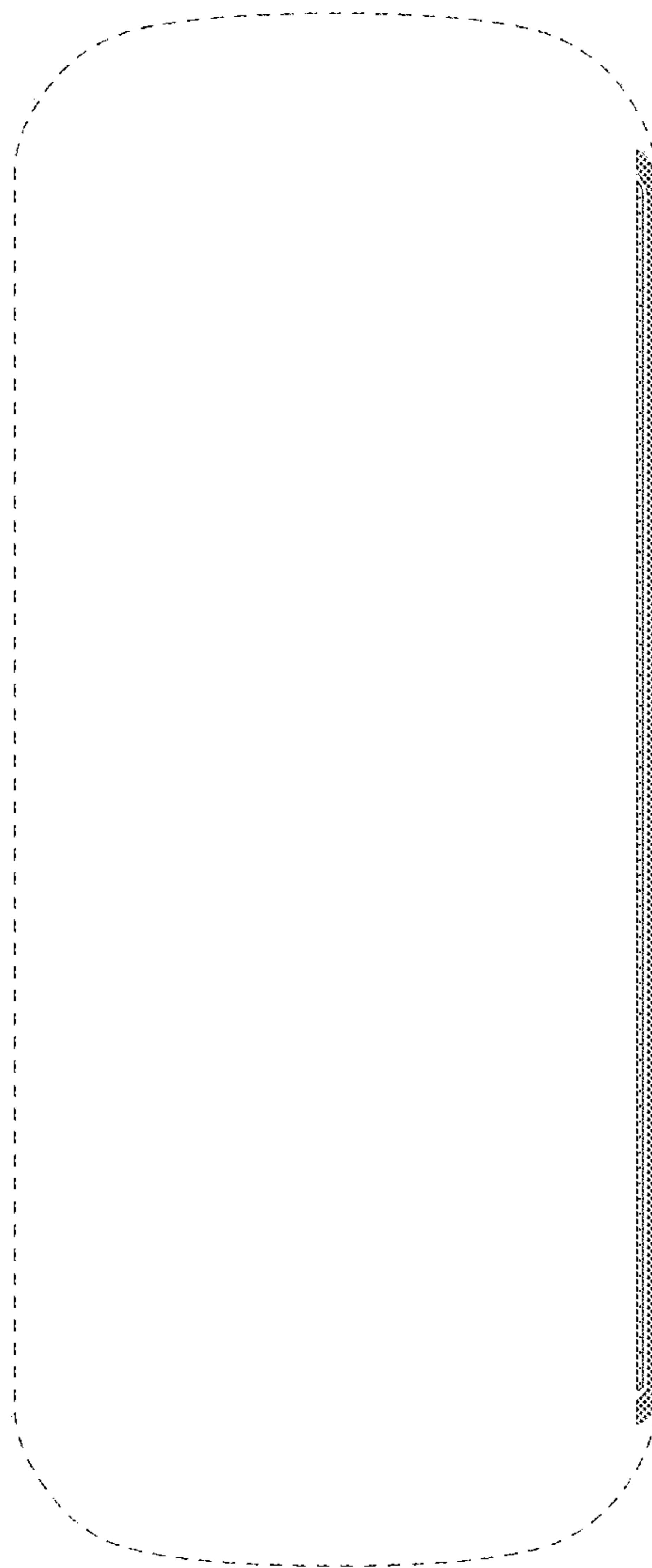

FIG. 6

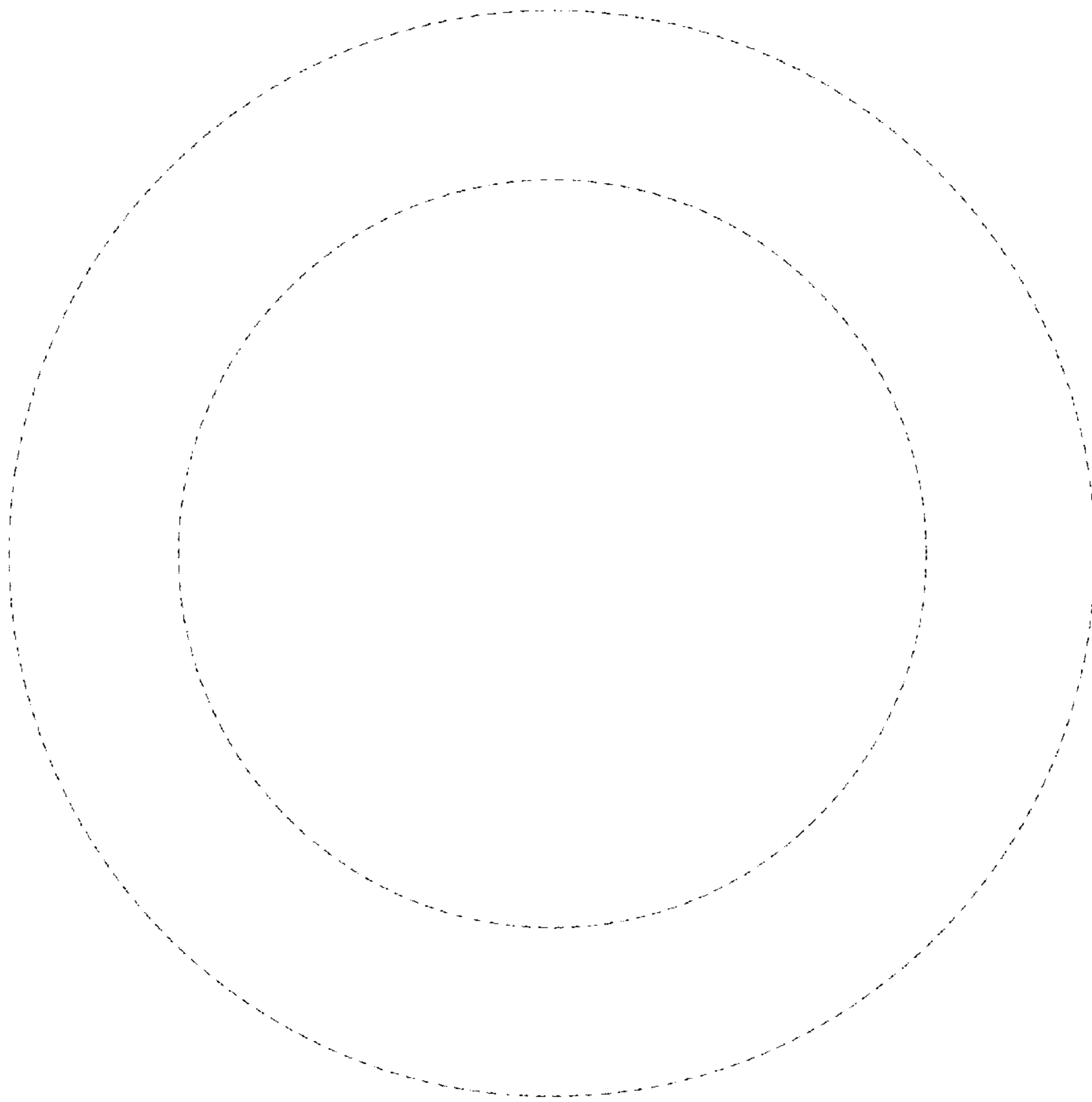

FIG. 7



FIG. 8

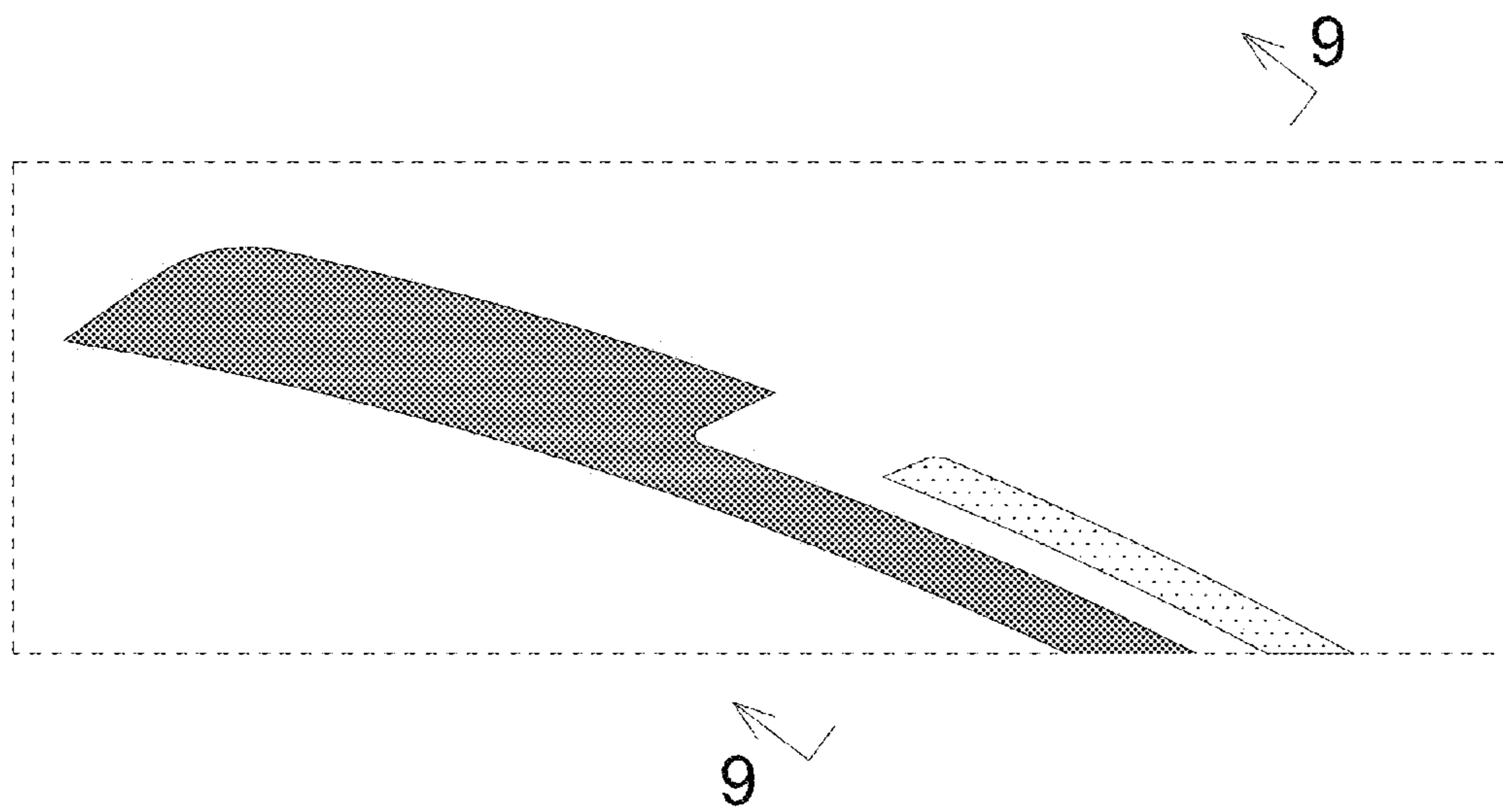

FIG. 9

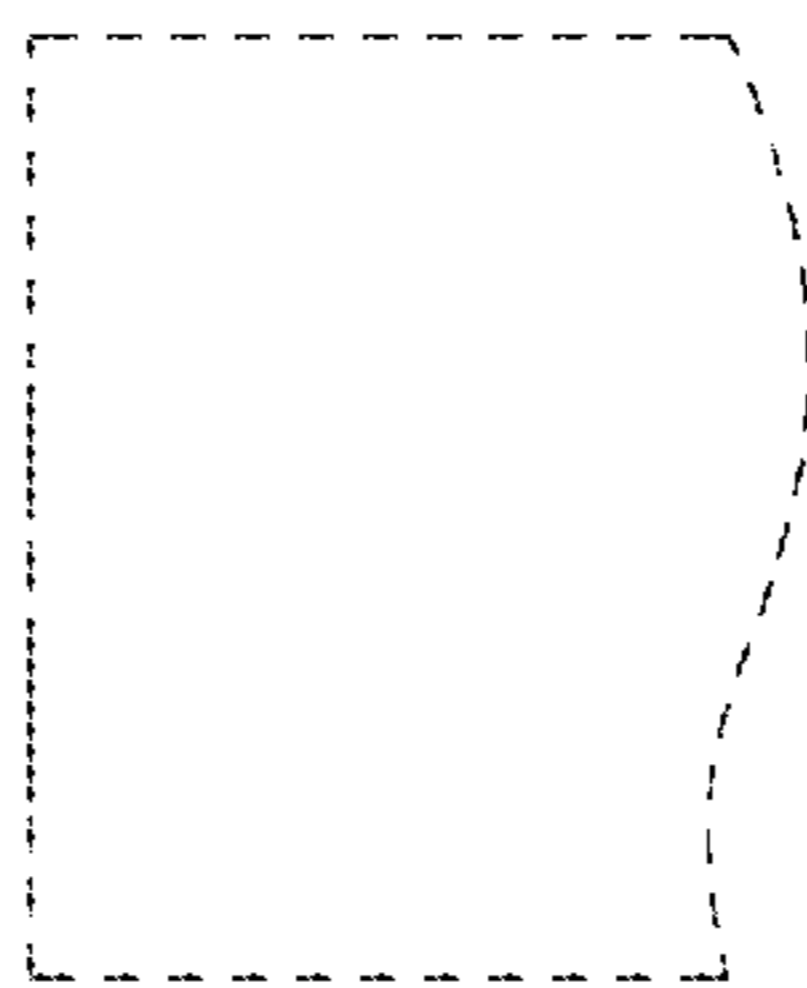

FIG. 10

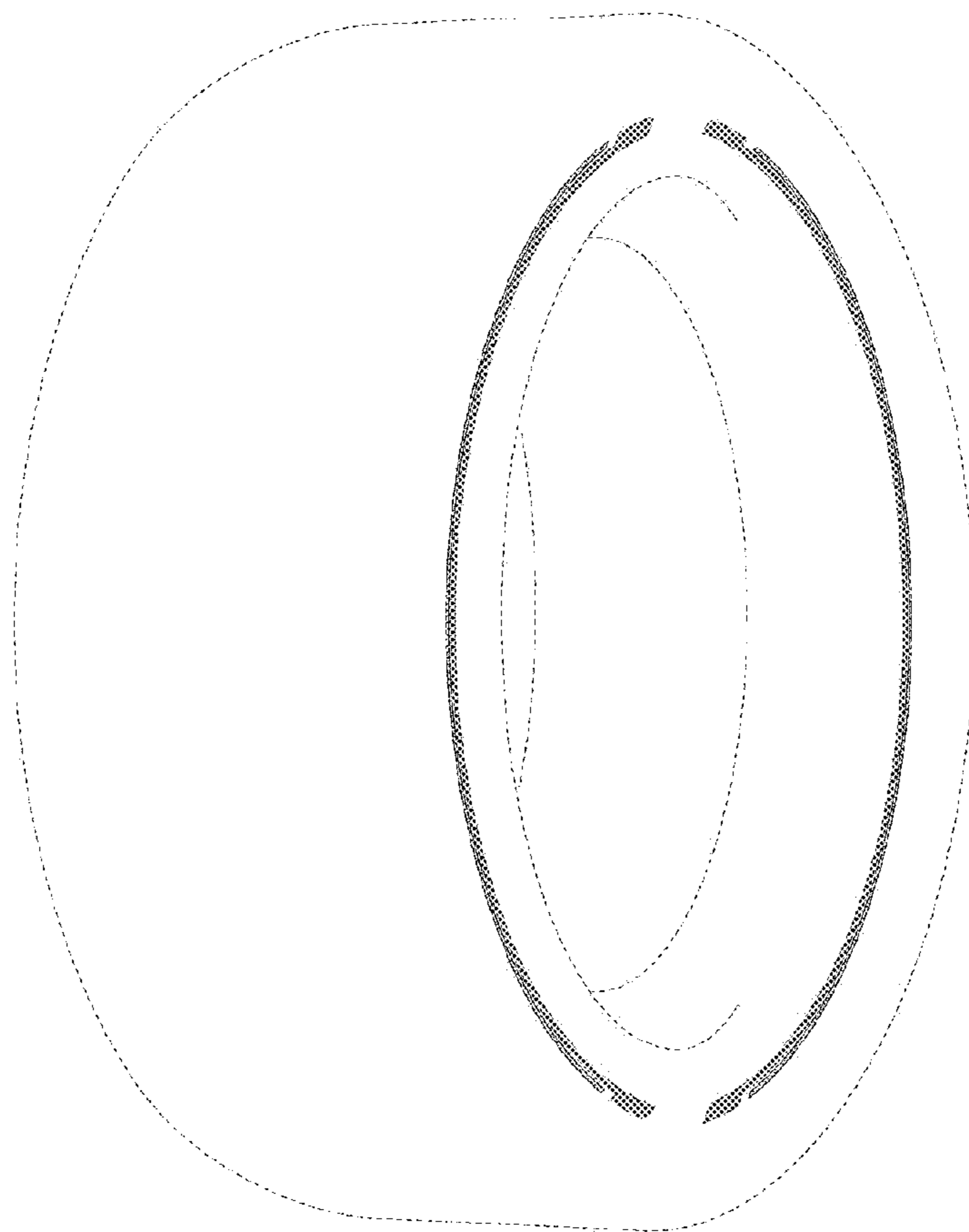

FIG. 11

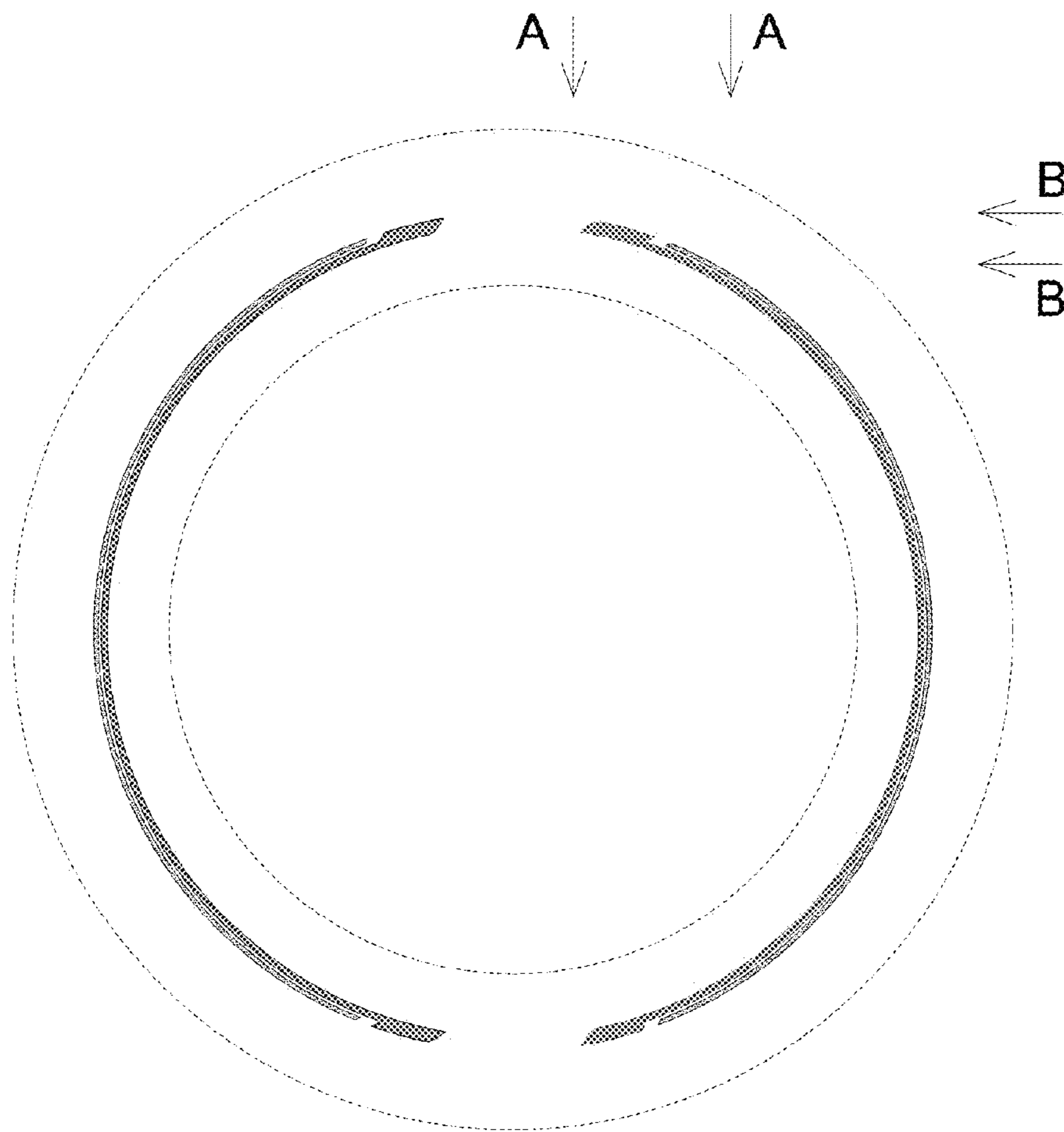

FIG. 12

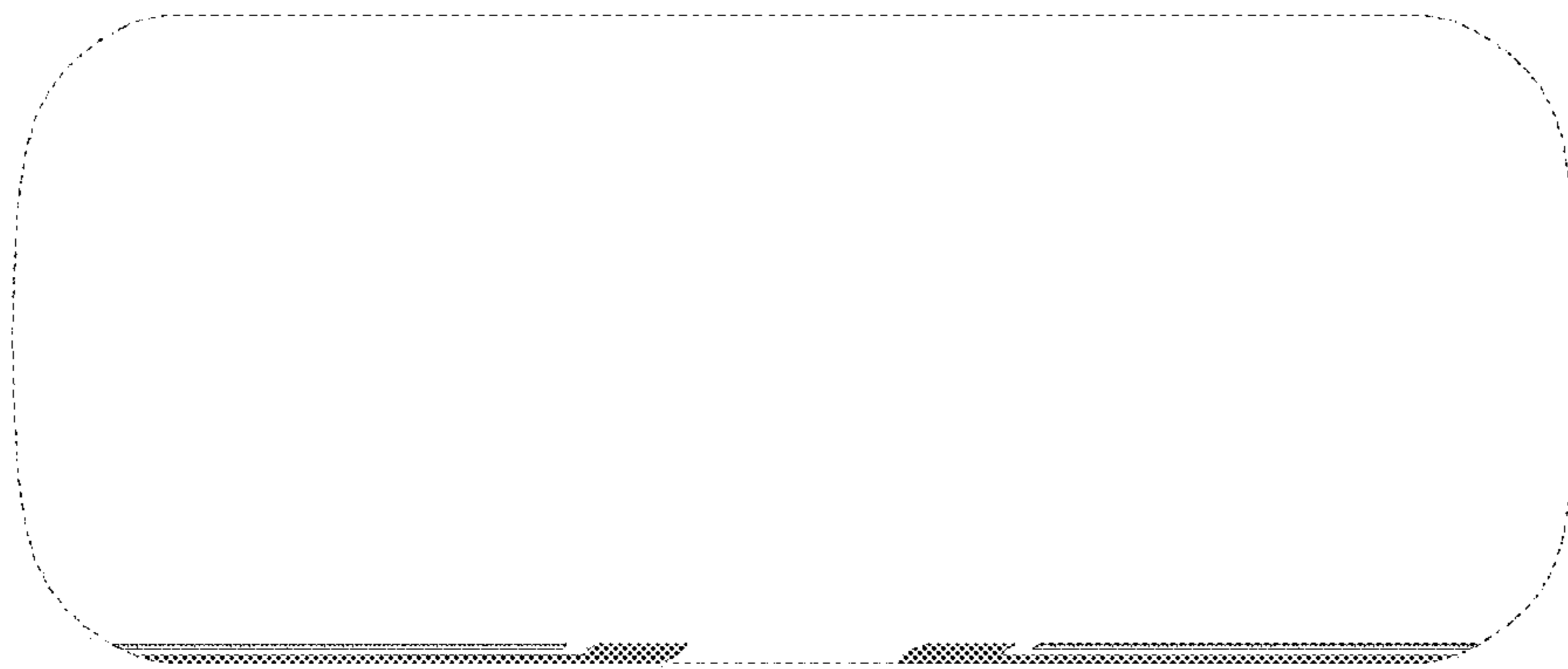

FIG. 13

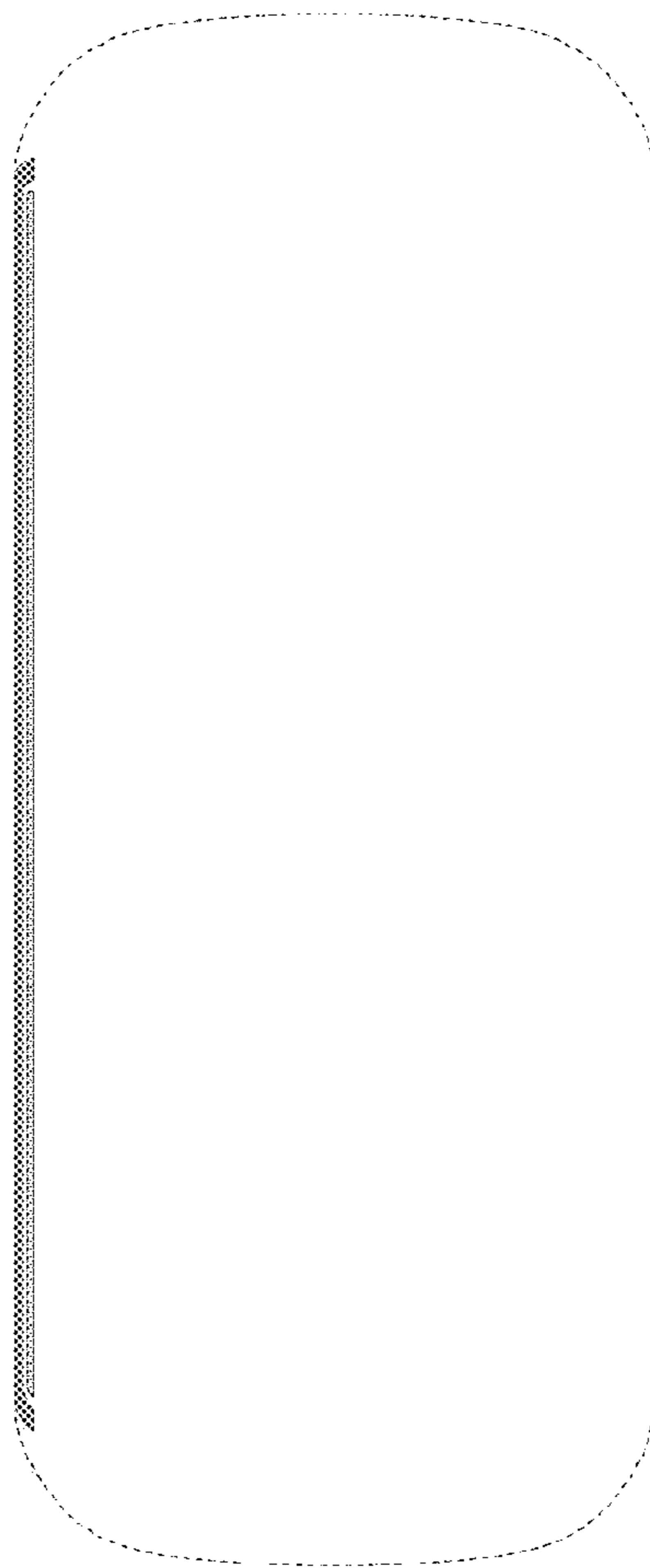

FIG. 14

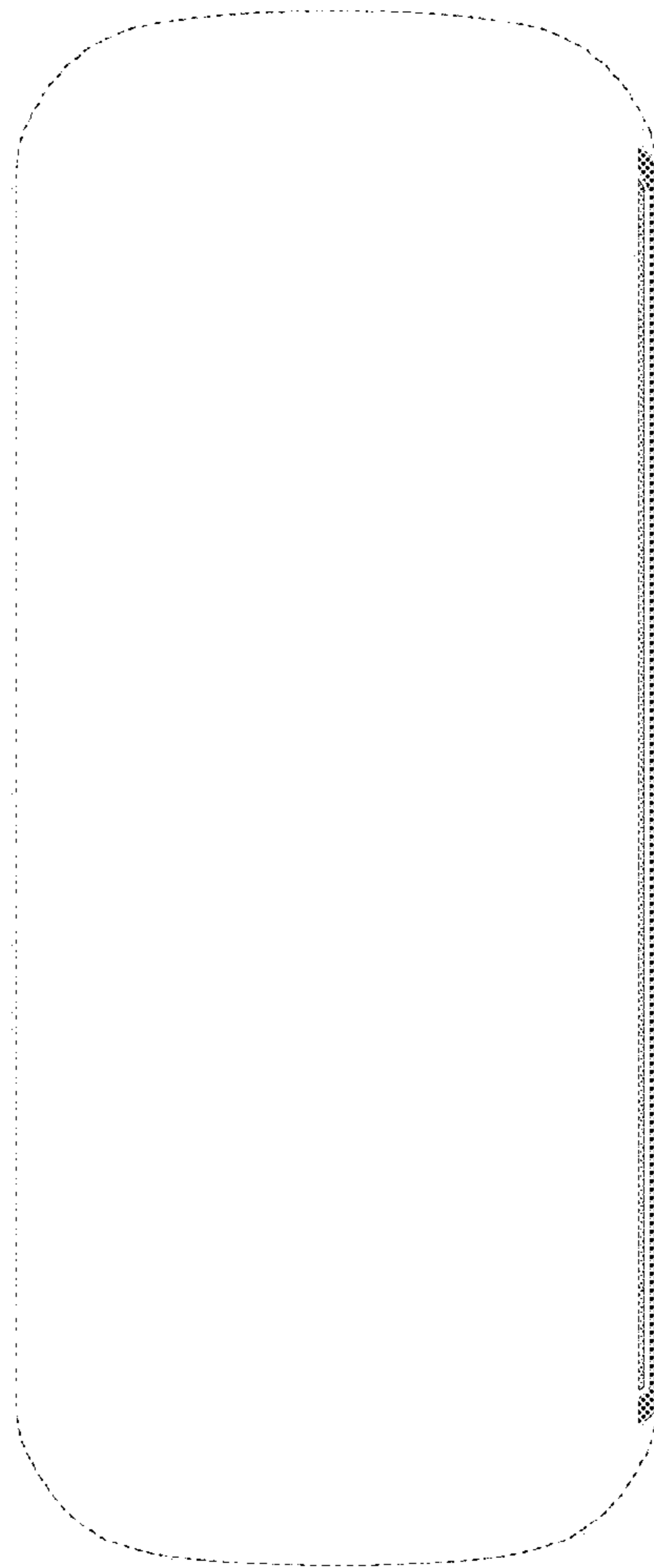

FIG. 15

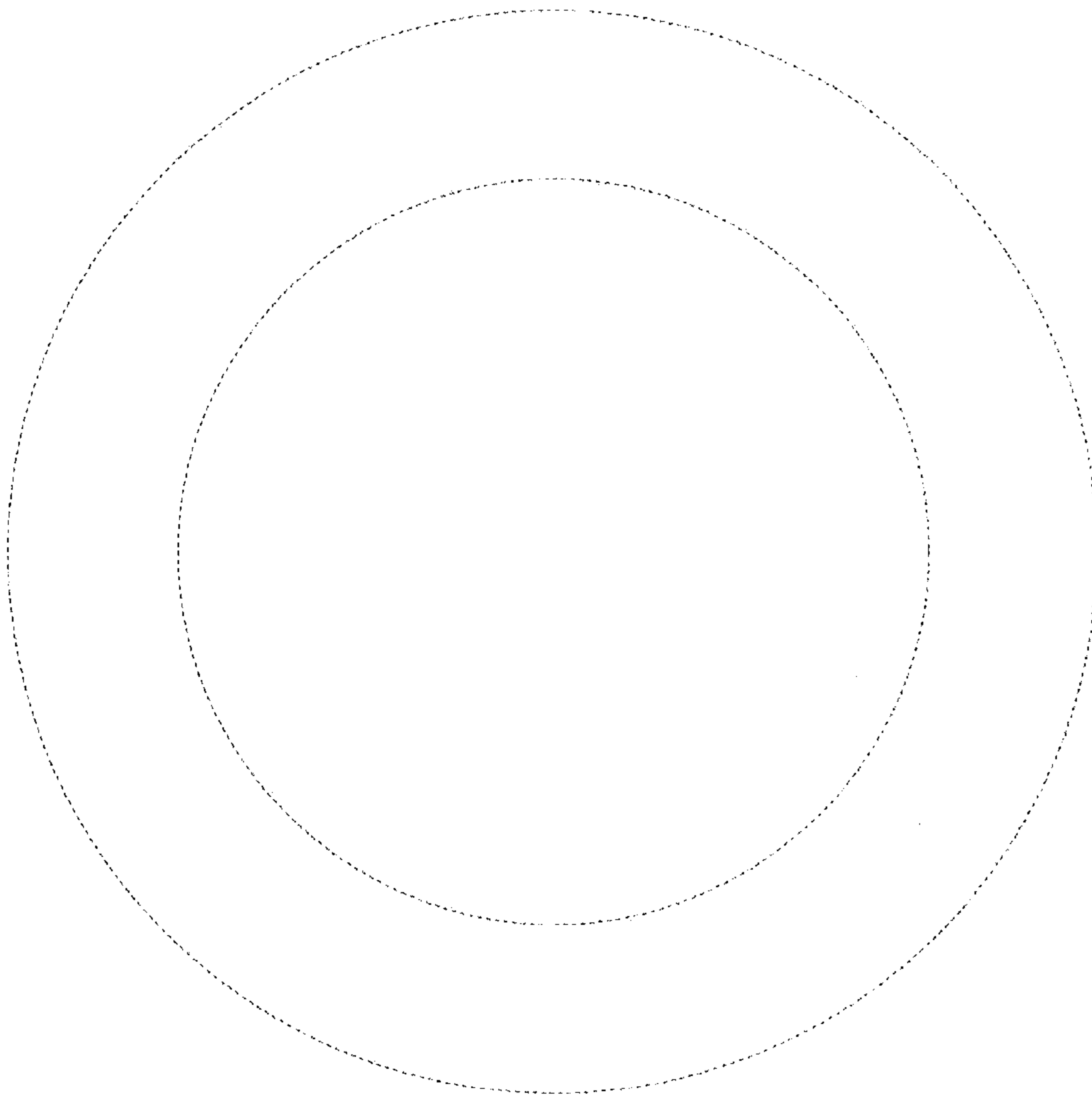

FIG. 16

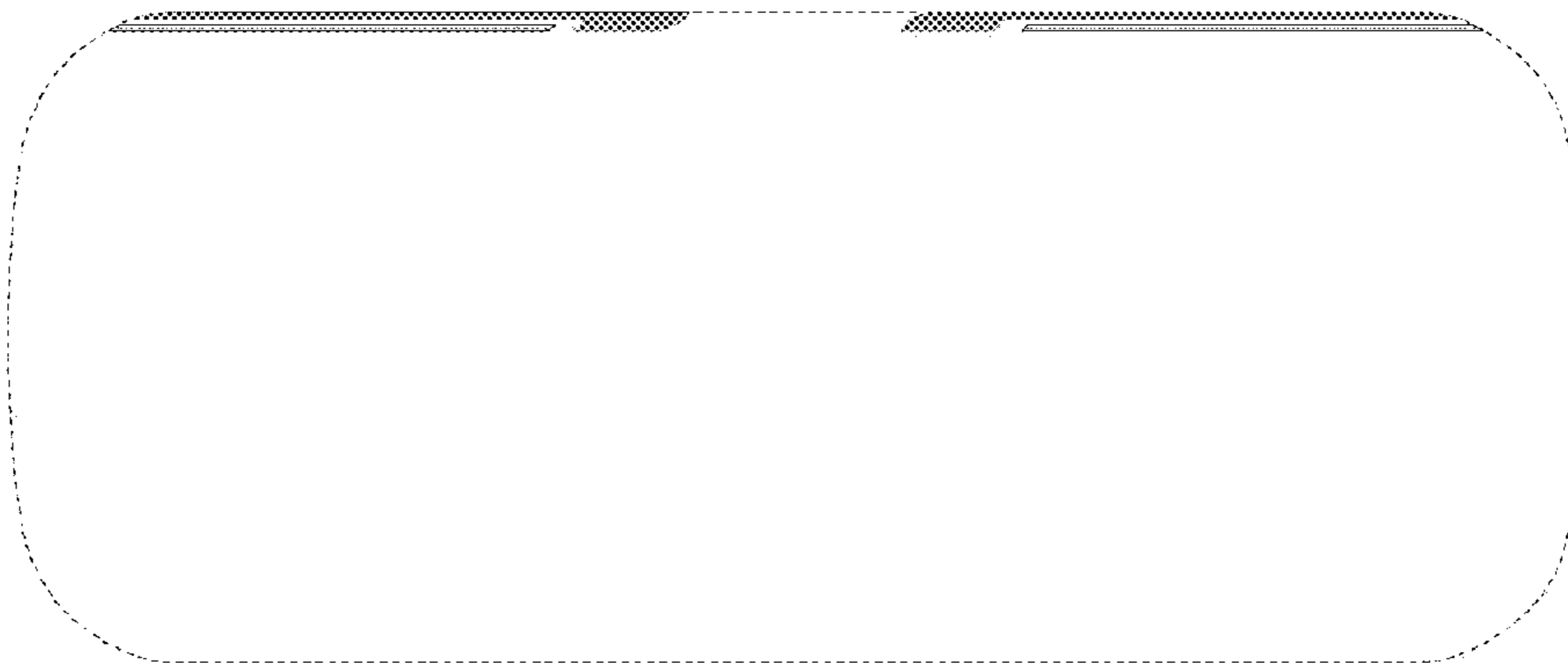

FIG. 17

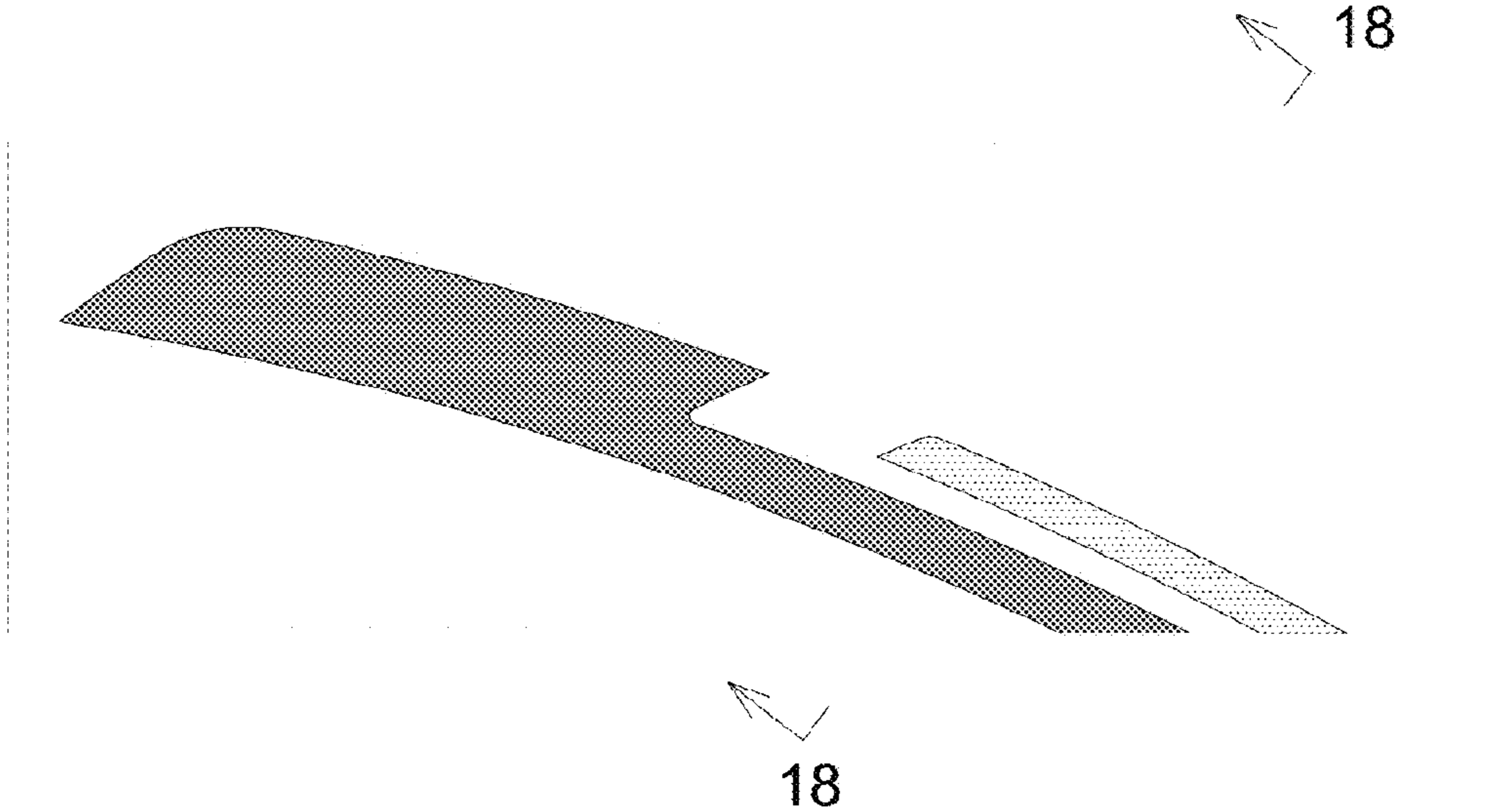

FIG. 18

