

US00D735079S

(12) **United States Design Patent**  
**Sperling et al.**

(10) **Patent No.:** **US D735,079 S**  
(45) **Date of Patent:** **\*\* Jul. 28, 2015**

(54) **AUTOMOBILE AND/OR TOY REPLICA THEREOF**

(71) Applicants: **Matthew Niven Sperling**, Huntington Beach, CA (US); **Kengo Iwanaga**, Ann Arbor, MI (US)

(72) Inventors: **Matthew Niven Sperling**, Huntington Beach, CA (US); **Kengo Iwanaga**, Ann Arbor, MI (US)

(73) Assignee: **Toyota Jidosha Kabushiki Kaisha**, Toyota-shi, Aichi-ken (JP)

(\*\*) Term: **14 Years**

(21) Appl. No.: **29/485,745**

(22) Filed: **Mar. 21, 2014**

(51) **LOC (10) Cl.** ..... **12-08**

(52) **U.S. Cl.**  
USPC ..... **D12/92**

(58) **Field of Classification Search**  
USPC ..... D12/86, 90-92; D21/421, 433, 434;  
296/181.1, 181.5

CPC ..... B62D 35/00; B62D 25/00; B62D 25/06;  
B62D 25/08; B62D 33/00

See application file for complete search history.

(56) **References Cited**

**U.S. PATENT DOCUMENTS**

D612,296 S *	3/2010	Miyazaki et al.	.....	D12/92
D620,841 S *	8/2010	Sakae et al.	.....	D12/92
D628,940 S *	12/2010	Bischoff et al.	.....	D12/92
D630,973 S *	1/2011	Bischoff et al.	.....	D12/92
D637,943 S *	5/2011	Bischoff et al.	.....	D12/92
D672,689 S *	12/2012	Kubota et al.	.....	D12/92
D678,126 S *	3/2013	Bischoff et al.	.....	D12/92
D679,221 S *	4/2013	Tomatsu et al.	.....	D12/92

D684,900 S *	6/2013	Doyle et al.	.....	D12/92
D700,870 S *	3/2014	Jevremovic et al.	.....	D12/92
D715,194 S *	10/2014	Kim et al.	.....	D12/92
D718,666 S *	12/2014	Hammoud et al.	.....	D12/92
D719,065 S *	12/2014	Sakae et al.	.....	D12/92

**OTHER PUBLICATIONS**

Netcarshow.com, URL: [http://www.netcarshow.com/toyota/2012-camry\\_hybrid/1024x768/wallpaper\\_12.htm](http://www.netcarshow.com/toyota/2012-camry_hybrid/1024x768/wallpaper_12.htm); [http://www.netcarshow.com/toyota/2012-camry\\_hybrid/2014x768/wallpaper\\_14.htm](http://www.netcarshow.com/toyota/2012-camry_hybrid/2014x768/wallpaper_14.htm); Model: Toyota Camry Hybrid (2012); Mfg. Toyota, (Sep. 13, 2013).

Netcarshow.com; URL: [http://www.netcarshow.com/lexus/2013-es350/1024x768/wallpaper\\_01.htm](http://www.netcarshow.com/lexus/2013-es350/1024x768/wallpaper_01.htm); Model: Lexus ES350 (2013); Mfg.: Lexus (Sep. 13, 2013).

(Continued)

*Primary Examiner* — Melody N Brown

(74) *Attorney, Agent, or Firm* — Finnegan, Henderson, Farabow, Garrett & Dunner, LLP

(57) **CLAIM**

The ornamental design for an automobile and/or toy replica thereof, as shown and described.

**DESCRIPTION**

FIG. 1 is a front left perspective view of an automobile and/or toy replica thereof of our new design; FIG. 2 is a rear left perspective view thereof; FIG. 3 is a front view thereof; FIG. 4 is a rear view thereof; FIG. 5 is a left side elevation view thereof; FIG. 6 is a right side elevation view thereof; and, FIG. 7 is a top plan view thereof.

The bottom view forms no part of the claimed design.

The broken lines in FIGS. 1-7 depict environment and the elements depicted in these broken lines form no part of the claimed design.

**1 Claim, 6 Drawing Sheets**

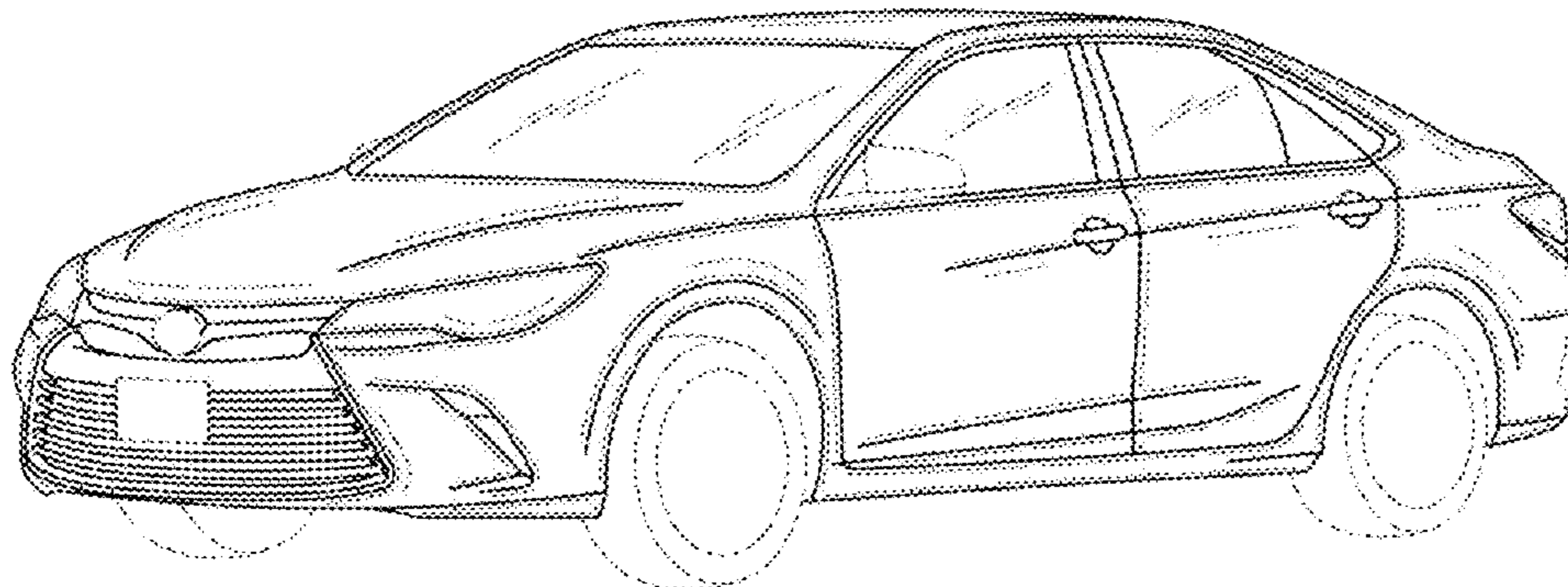

(56)

**References Cited**

OTHER PUBLICATIONS

Netcarshow.com; URL: [http://www.netcarshow.com/lexus/2013-es\\_300h/1024x768/wallpaper\\_12.htm](http://www.netcarshow.com/lexus/2013-es_300h/1024x768/wallpaper_12.htm); Model: Lexus ES 300h (2013); Mfg. Lexus: (Sep. 13, 2013).

Netcarshow.com; URL; [http://www.netcarshow.com/hyundai/2011-sonata/800x600/wallpaper\\_35.htm](http://www.netcarshow.com/hyundai/2011-sonata/800x600/wallpaper_35.htm); [http://www.netcarshow.com/hyundai/2011-sonata/800x600/wallpaper\\_37.htm](http://www.netcarshow.com/hyundai/2011-sonata/800x600/wallpaper_37.htm); Model: Hyundai Sonata (2011); Mfg.: Hyundai (Sep. 13, 2013).

\* cited by examiner

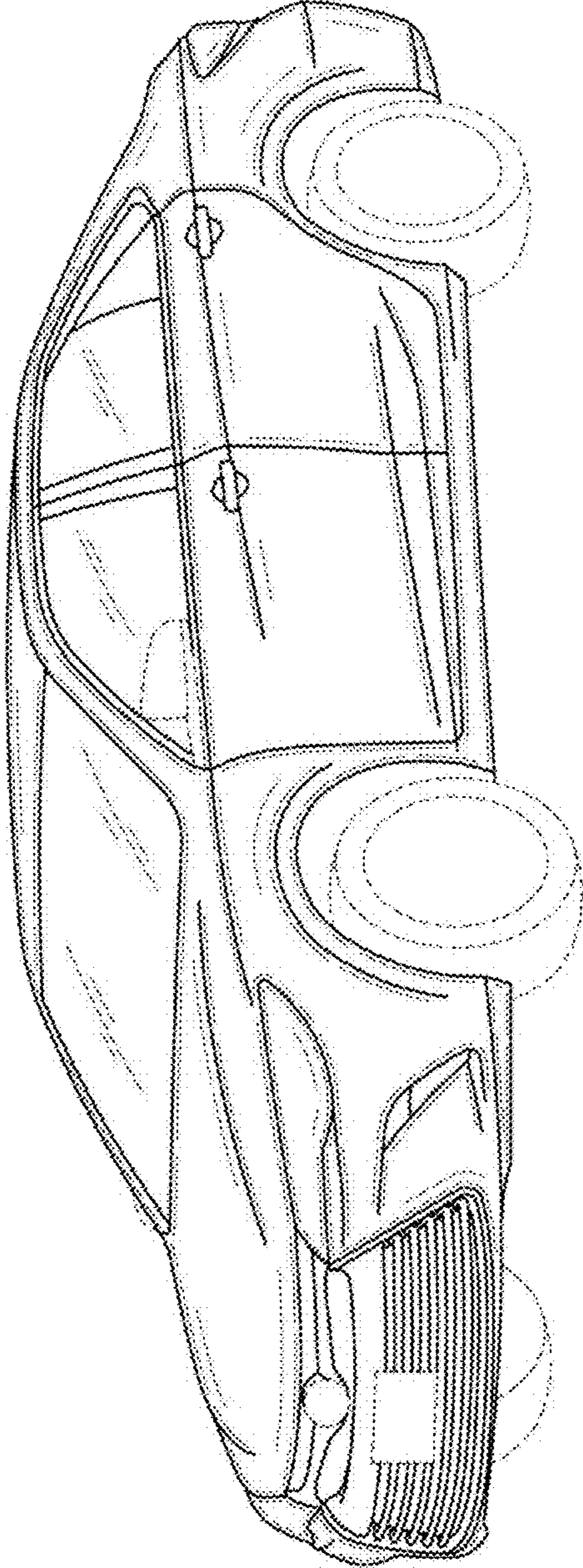

**FIG. 1**

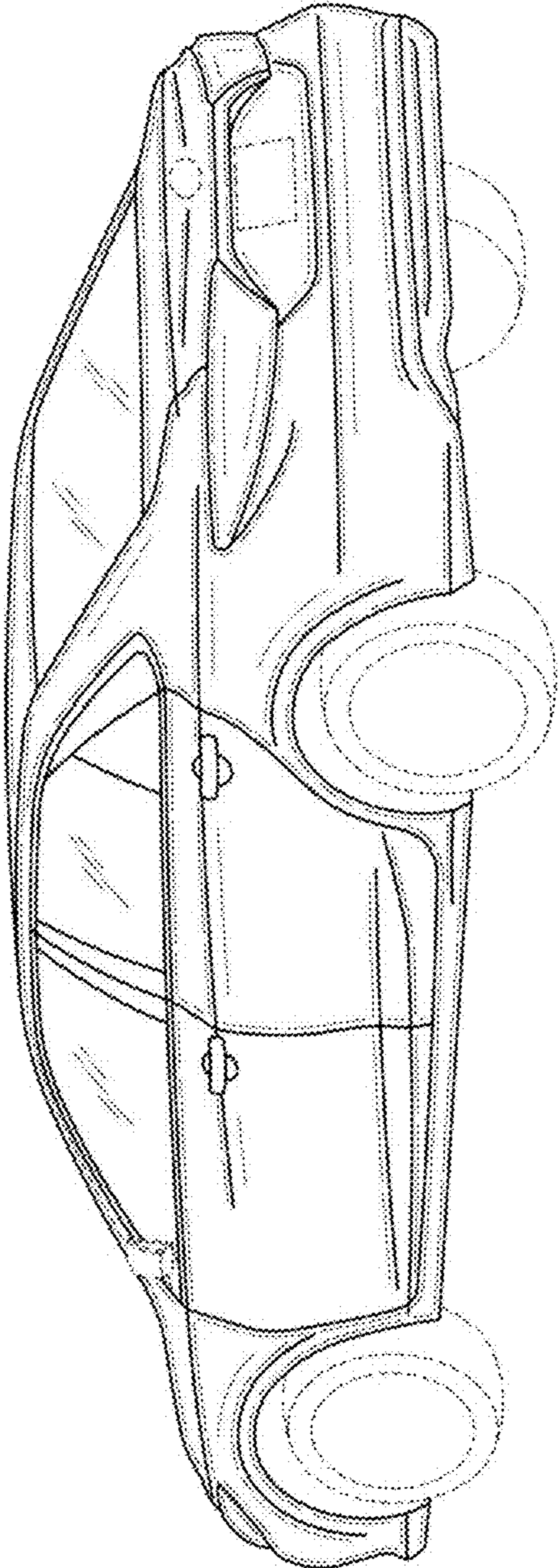

**FIG. 2**

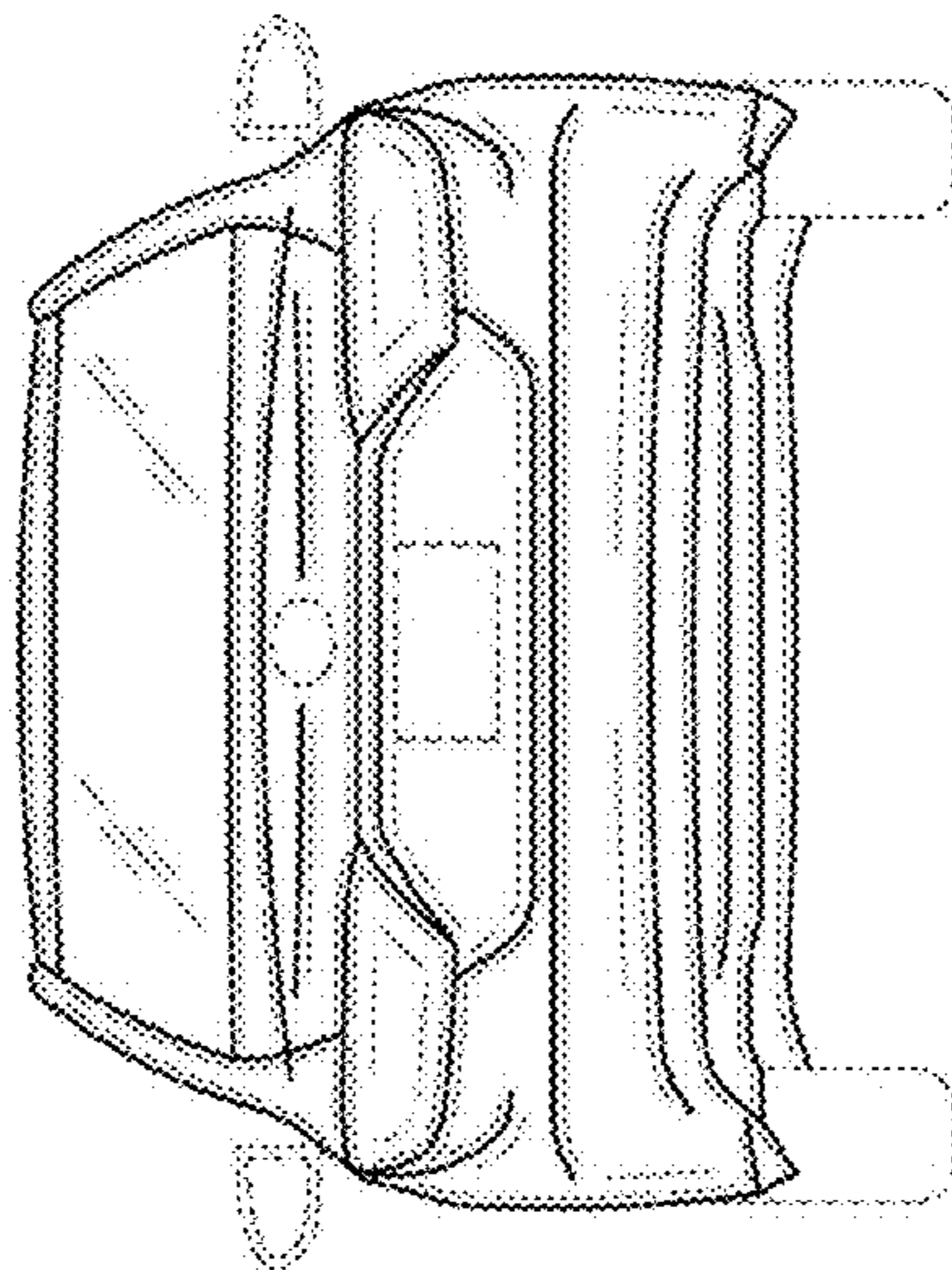

**FIG. 3**

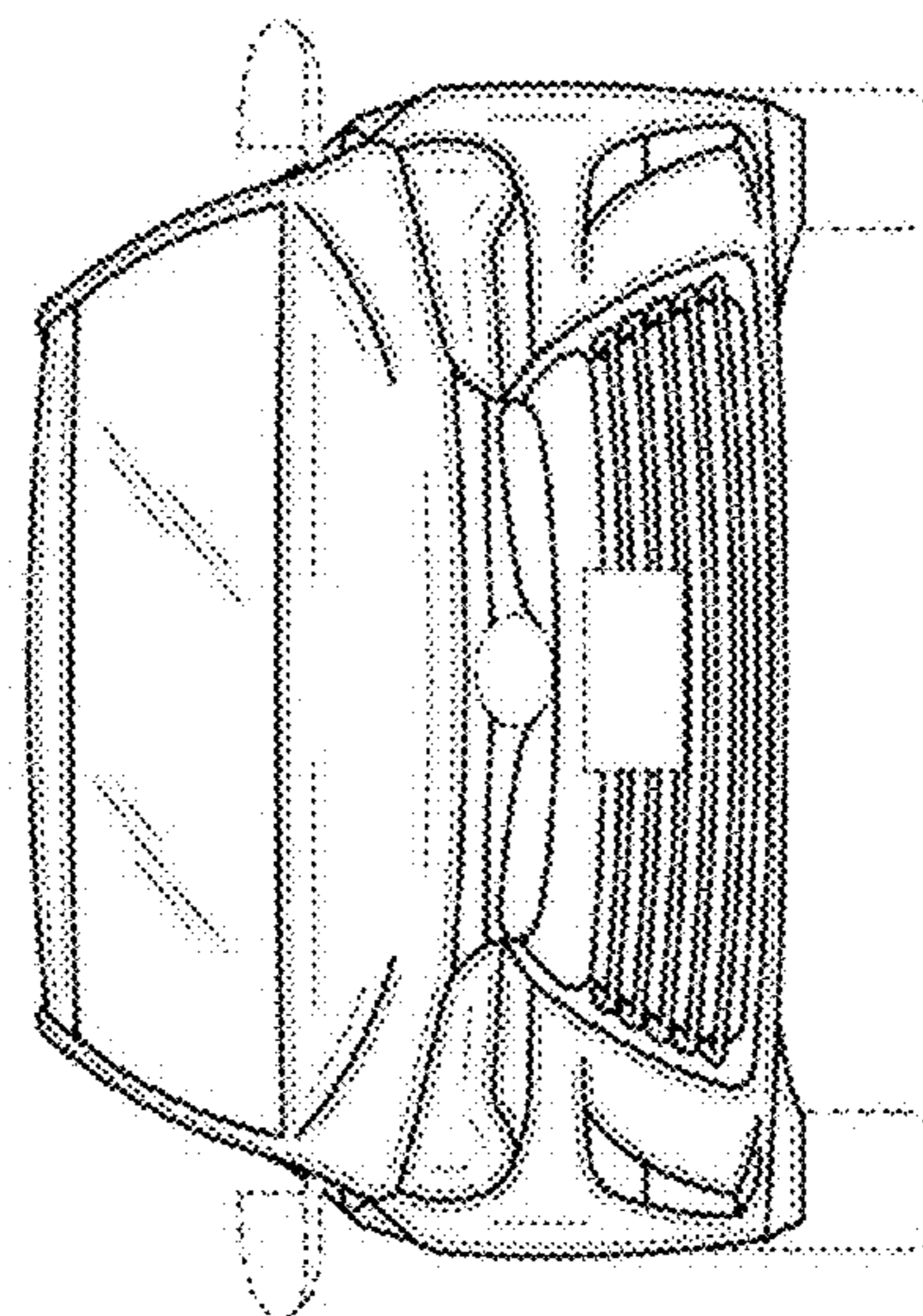

**FIG. 4**

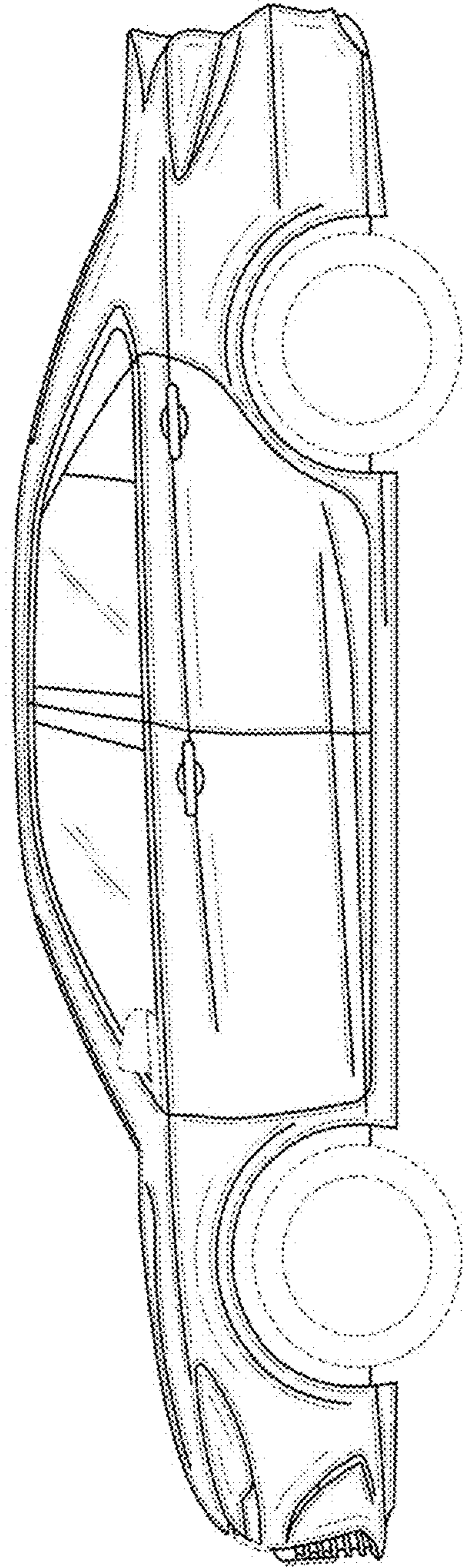

**FIG. 5**

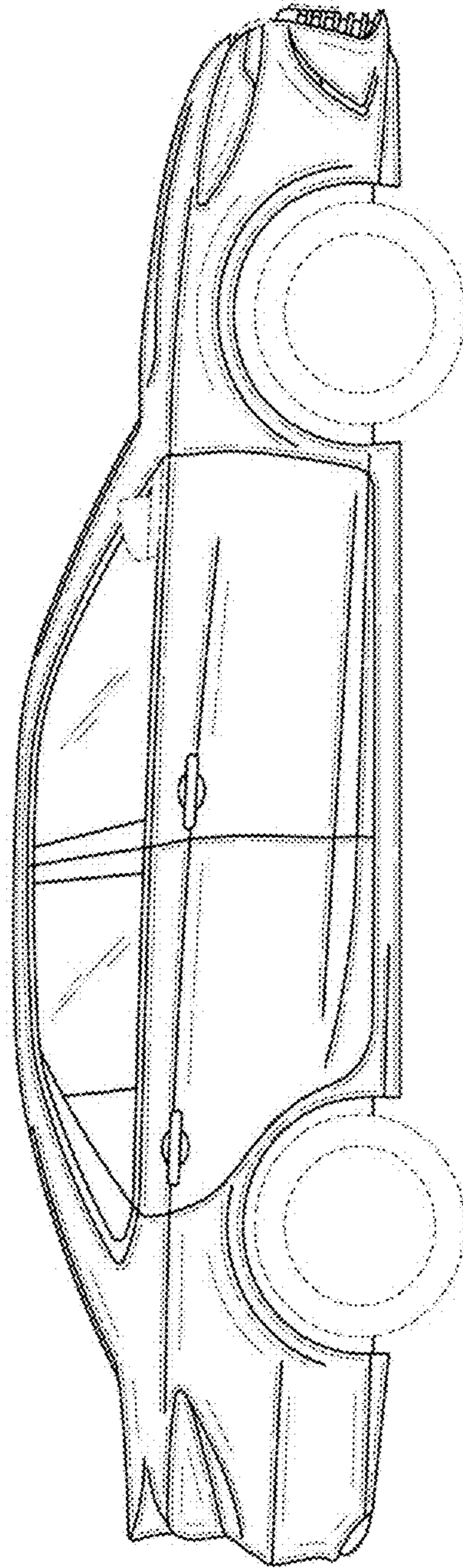

**FIG. 6**

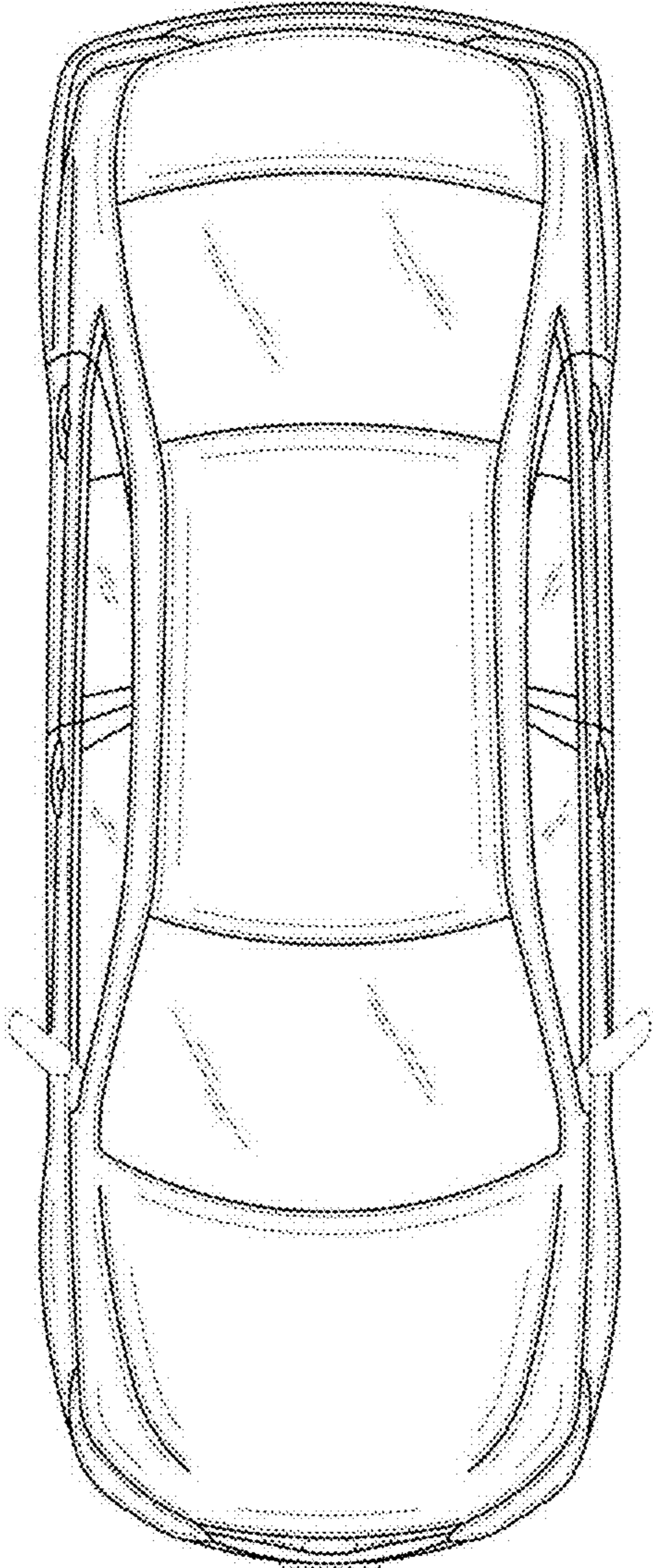

**FIG. 7**