



US00D735039S

(12) **United States Design Patent**
Pires et al.

(10) **Patent No.:** **US D735,039 S**

(45) **Date of Patent:** **** *Jul. 28, 2015**

(54) **FLASK WITH CAP**

(71) Applicant: **Natura Cosméticos S.A.**, Itaipericica da Serra (BR)

(72) Inventors: **Larissa Fortunato Pires**, São Paulo (BR); **Gustavo Senna Chelles**, São Paulo (BR); **Marcio Miranda de Faria**, Vinhedo (BR); **Marilia Gabriela Guerreiro Pinheiro**, Vila Dalila (BR)

(73) Assignee: **NATURA COSMETICOS S.A.**, Itaipericica da Serra SP (BR)

(*) Notice: This patent is subject to a terminal disclaimer.

(**) Term: **14 Years**

(21) Appl. No.: **29/471,900**

(22) Filed: **Nov. 6, 2013**

Related U.S. Application Data

(62) Division of application No. 29/438,380, filed on Nov. 29, 2012, now Pat. No. Des. 704,070.

(30) **Foreign Application Priority Data**

May 31, 2012 (BR) 302012002756-0

(51) **LOC (10) Cl.** **09-01**

(52) **U.S. Cl.**
USPC **D9/504**

(58) **Field of Classification Search**
USPC D9/682-694, 500-505, 719, 434-436, D9/414, 424, 428; 215/379, 382; 220/669, 220/675; D28/76, 77, 90, 91.1
See application file for complete search history.

(56) **References Cited**

U.S. PATENT DOCUMENTS

| | | | |
|--------------|---------|------------------------|--------|
| D43,239 S * | 11/1912 | Tuttle | D9/776 |
| D180,820 S * | 8/1957 | DuPree | D7/317 |
| D197,308 S * | 1/1964 | Sterges | D9/502 |
| D230,954 S * | 3/1974 | Gregoriotti | D9/504 |
| D273,766 S * | 5/1984 | Lampe | D9/504 |
| D281,764 S * | 12/1985 | Legrottaglie | D9/504 |
| D284,451 S * | 7/1986 | Fortuna | D9/504 |
| D306,965 S * | 4/1990 | Jaworski | D9/689 |
| D328,025 S * | 7/1992 | Farricielli | D9/691 |
| D340,618 S * | 10/1993 | Zimmerman | D7/591 |
| D465,149 S * | 11/2002 | Bennett et al. | D9/691 |
| D477,535 S * | 7/2003 | Thorpe | D9/504 |
| D485,017 S * | 1/2004 | Noh | D28/76 |
| D519,376 S * | 4/2006 | Ames | D9/504 |
| D538,668 S * | 3/2007 | Campbell et al. | D9/529 |
| D540,170 S * | 4/2007 | Canamasas Puigbo | D9/504 |
| D548,084 S * | 8/2007 | Dittmer et al. | D9/504 |
| D594,746 S * | 6/2009 | Moretti | D9/445 |
| D596,950 S * | 7/2009 | Nevins et al. | D9/690 |

(Continued)

FOREIGN PATENT DOCUMENTS

JP D1301541 5/2007

Primary Examiner — Catherine Tuttle

(74) *Attorney, Agent, or Firm* — B. Aaron Schulman, Esq.; Stites & Harbison, PLLC.

(57) **CLAIM**

The ornamental design for a flask with cap, as shown and described.

DESCRIPTION

FIG. 1 is a perspective view showing the new design for the flask with cap of the present application;
FIG. 2 is a front view thereof;
FIG. 3 is a side view thereof;
FIG. 4 is a back view thereof;
FIG. 5 is a top view thereof; and,
FIG. 6 is a bottom view thereof.

1 Claim, 1 Drawing Sheet

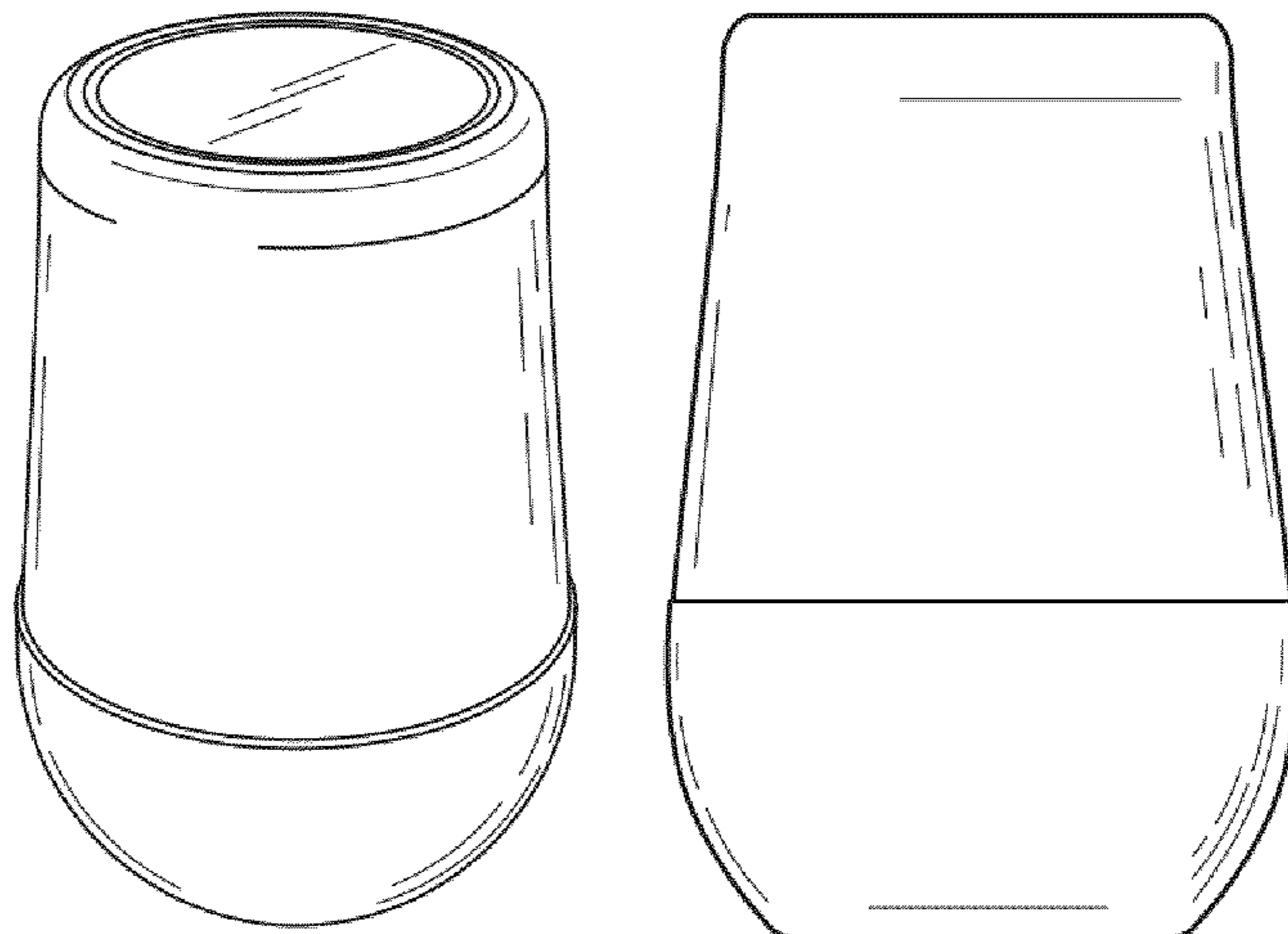

(56)

References Cited

U.S. PATENT DOCUMENTS

| | | | |
|--------------|---------|---------------------|--------|
| D616,304 S * | 5/2010 | Prunier et al. | D9/504 |
| D619,894 S * | 7/2010 | Ashiwa et al. | D9/504 |
| D668,552 S * | 10/2012 | Wisniewski | D9/689 |
| D607,734 S * | 1/2010 | Kuzma et al. | D9/539 |

* cited by examiner

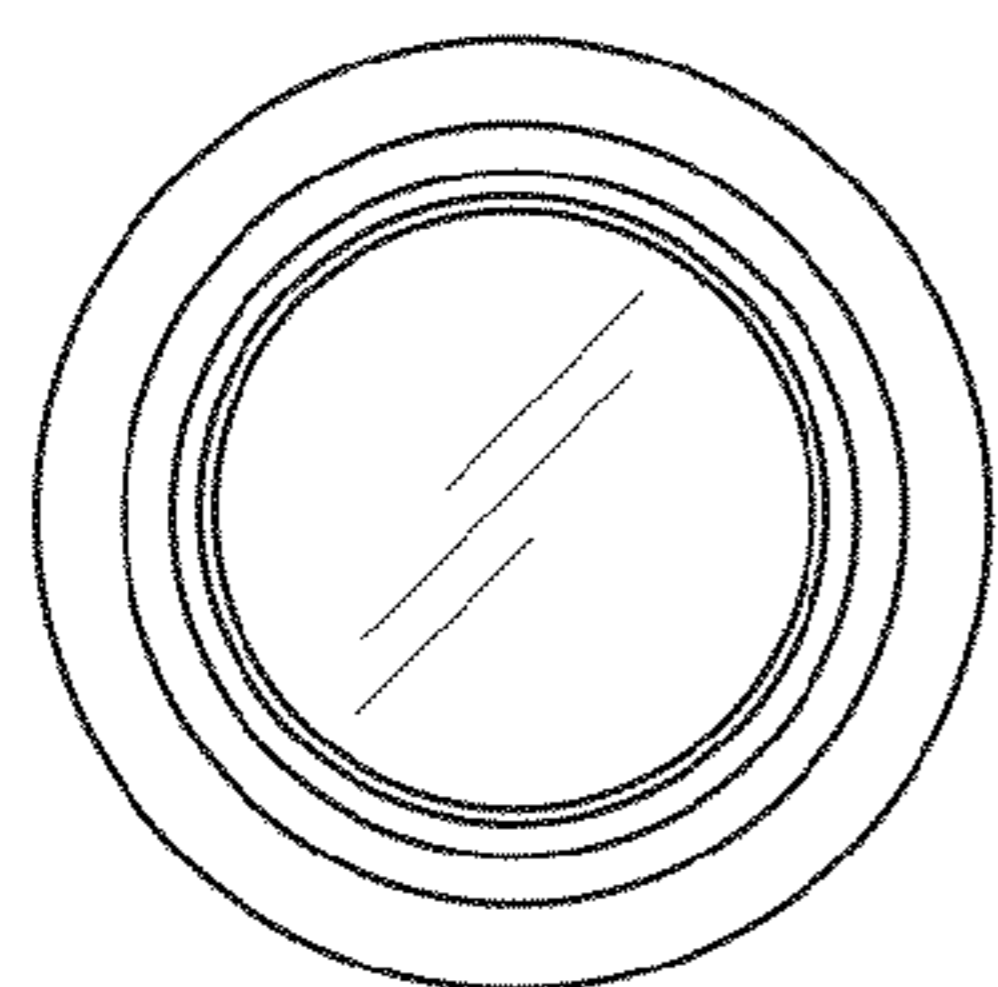

FIG. 5

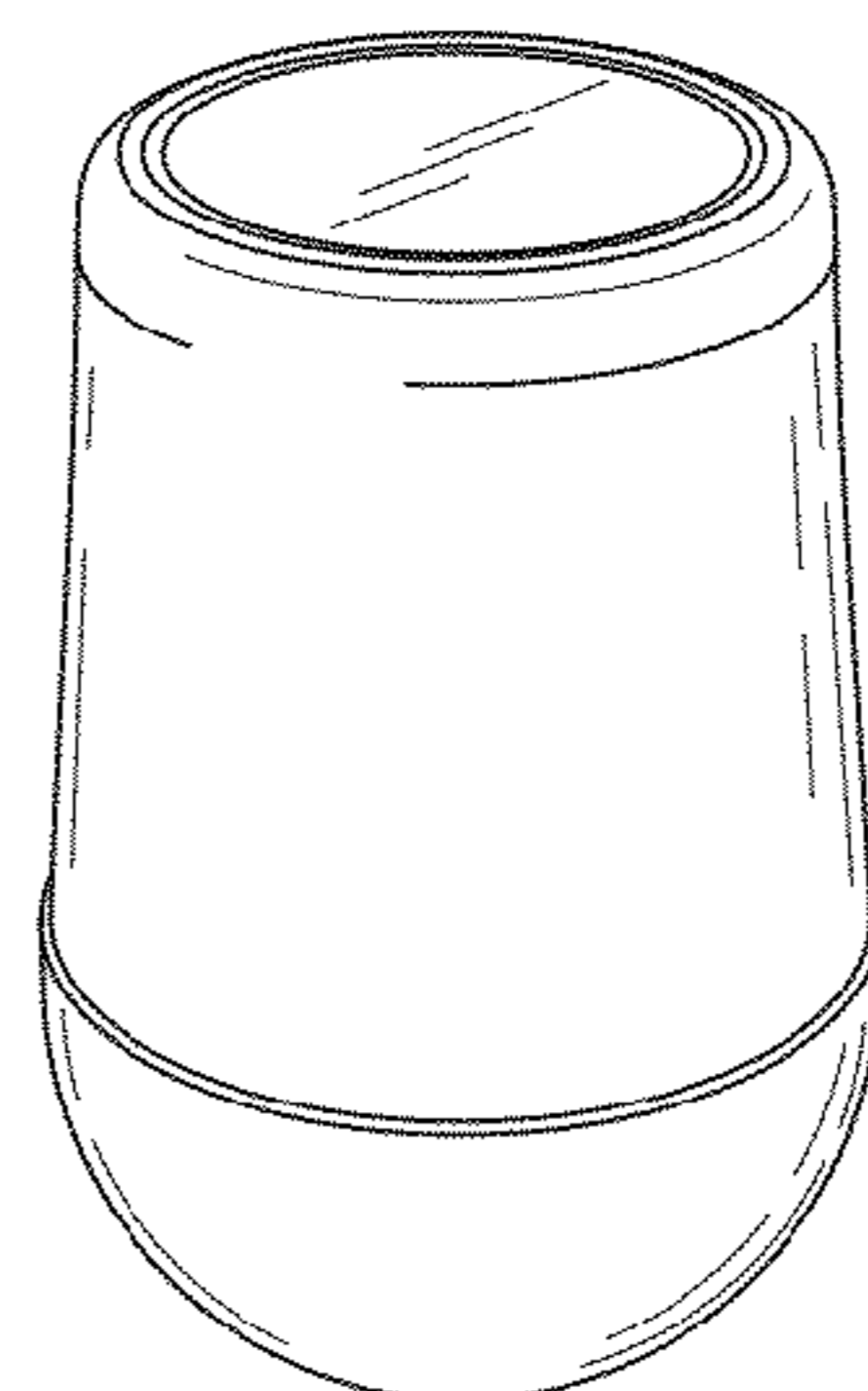

FIG. 1

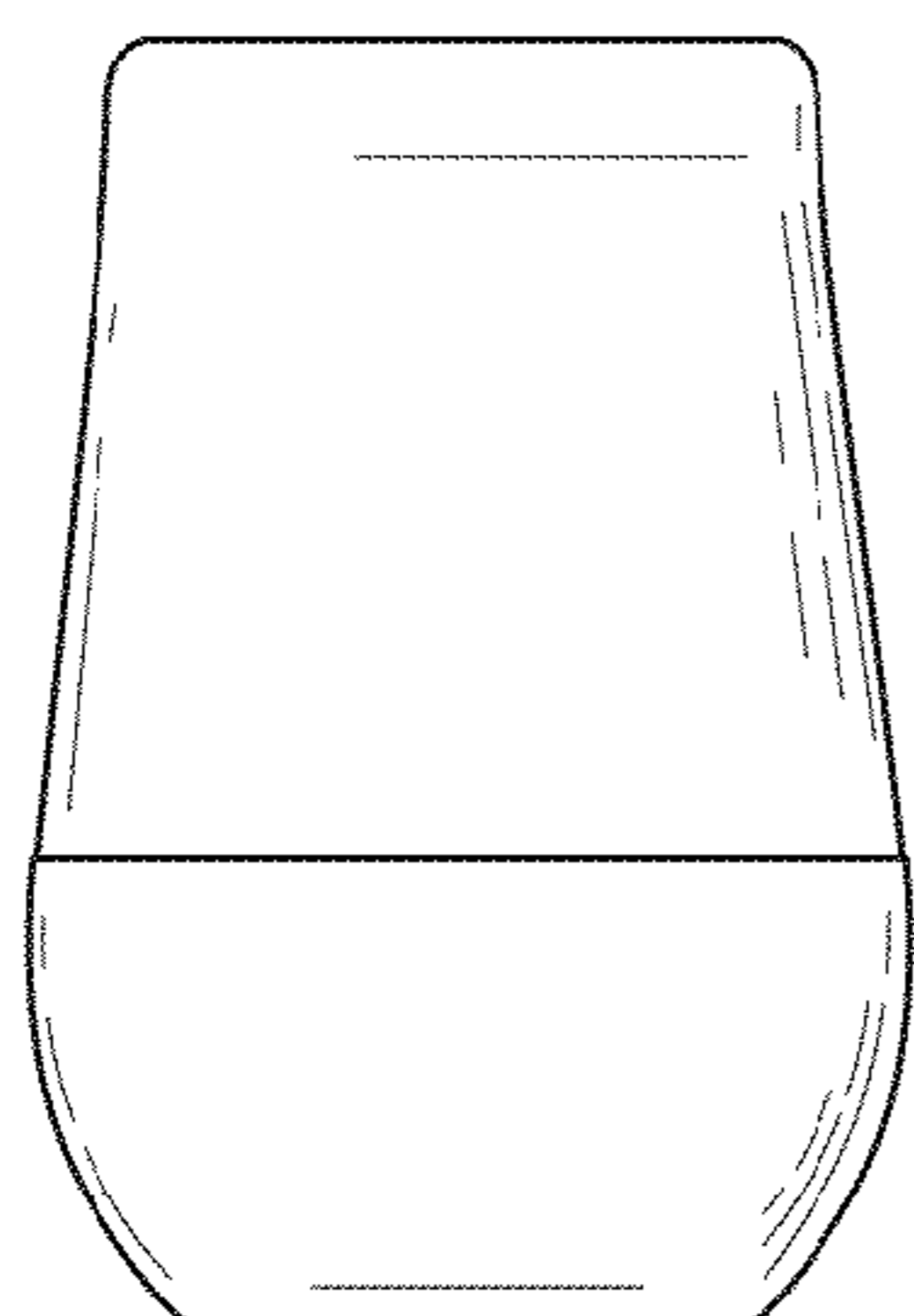

FIG. 2

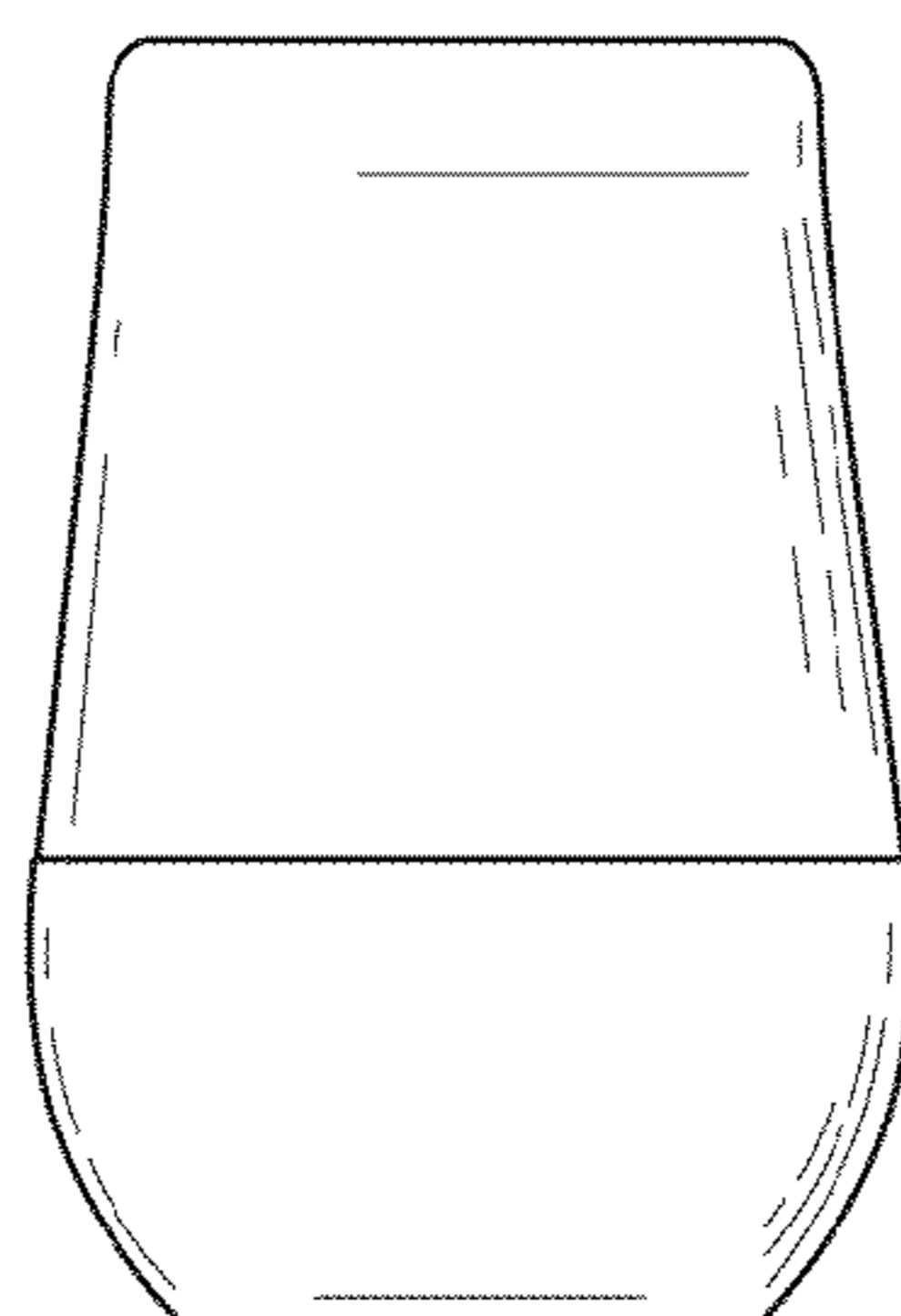

FIG. 3

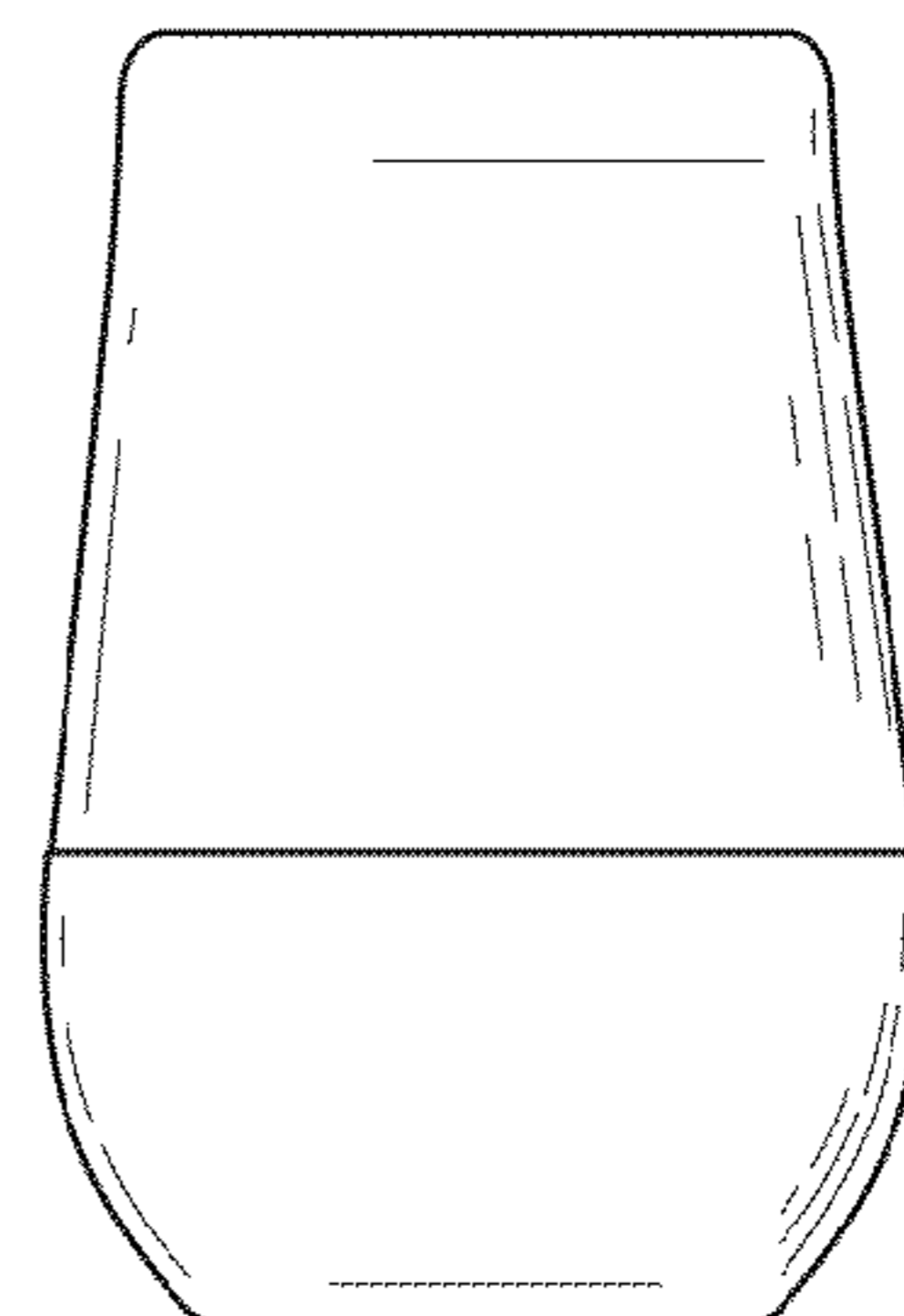

FIG. 4

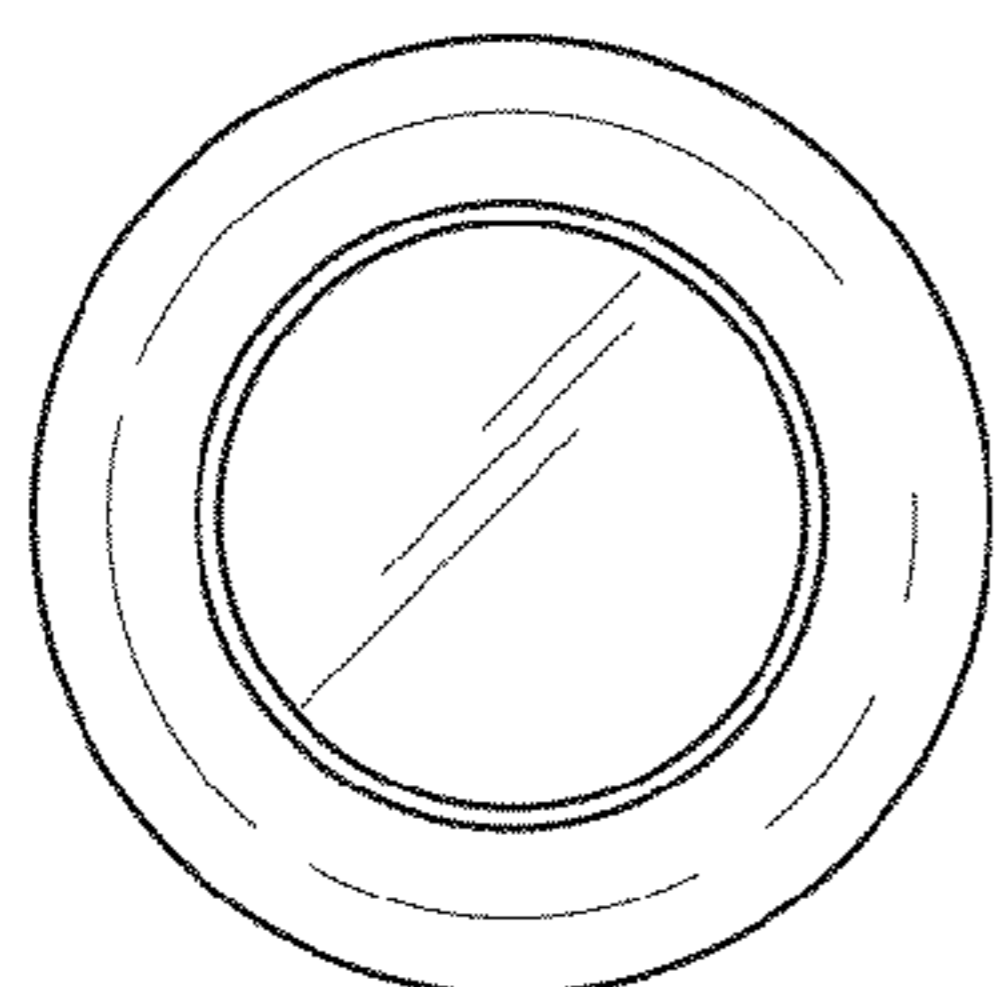

FIG. 6