



US00D734994S

(12) **United States Design Patent**  
**Lee**

(10) **Patent No.:** **US D734,994 S**  
(45) **Date of Patent:** **\*\* \*Jul. 28, 2015**

- (54) **COCKTAIL STRAINER**
- (71) Applicant: **Cocktail Kingdom LLC**, New York, NY (US)
- (72) Inventor: **Don H. Lee**, New York, NY (US)
- (73) Assignee: **Cocktail Kingdom LLC**, New York, NY (US)
- (\*) Notice: This patent is subject to a terminal disclaimer.
- (\*\*) Term: **14 Years**
- (21) Appl. No.: **29/484,293**
- (22) Filed: **Mar. 7, 2014**
- (51) **LOC (10) Cl.** ..... **07-04**
- (52) **U.S. Cl.**  
USPC ..... **D7/667**
- (58) **Field of Classification Search**  
USPC ..... D7/667, 668; 99/275; 222/189.06, 222/189.07; 210/464-475, 482, 495, 498, 210/499, 497.01; 100/110, 104  
CPC ..... E04D 13/076; B30B 9/02; A47J 43/27; A47J 43/286; A47J 43/284; A47J 31/02  
See application file for complete search history.

- 2012/0061398 A1\* 3/2012 Nilsson ..... 220/568
- 2012/0147693 A1\* 6/2012 Bahlenhorst et al. .... 366/130
- 2013/0160213 A1\* 6/2013 Salles ..... 7/119

\* cited by examiner

*Primary Examiner* — Terry Wallace  
(74) *Attorney, Agent, or Firm* — Stroock & Stroock & Lavan LLP; Jason M. Sobel

(57) **CLAIM**  
The ornamental design for a cocktail strainer, as shown and described.

**DESCRIPTION**

FIG. 1 is a perspective view of the underside of a cocktail strainer, constructed in accordance with the present invention;  
 FIG. 2 is a perspective view of the topside of the cocktail strainer of FIG. 1;  
 FIG. 3 is a second perspective view of the underside of the cocktail strainer of FIG. 1;  
 FIG. 4 is an underside view of the cocktail strainer of FIG. 1;  
 FIG. 5 is a topside view of the cocktail strainer of FIG. 1;  
 FIG. 6 is a bottom edge view of the cocktail strainer of FIG. 1;  
 FIG. 7 is a top edge view of the cocktail strainer of FIG. 1; and,  
 FIG. 8 is a side edge view of the cocktail strainer of FIG. 1. The elements delineated in dashed or broken lines forms no part of the claimed design of the cocktail strainer. The elements below the wide-dashed boundary line in FIGS. 1, 2, 3, 4, 5, and 8 forms no part of the claimed design of the cocktail strainer.

- (56) **References Cited**  
U.S. PATENT DOCUMENTS  
1,044,869 A \* 11/1912 Emmenegger ..... 30/325  
8,631,722 B1 \* 1/2014 Davis ..... 81/3.09

**1 Claim, 7 Drawing Sheets**

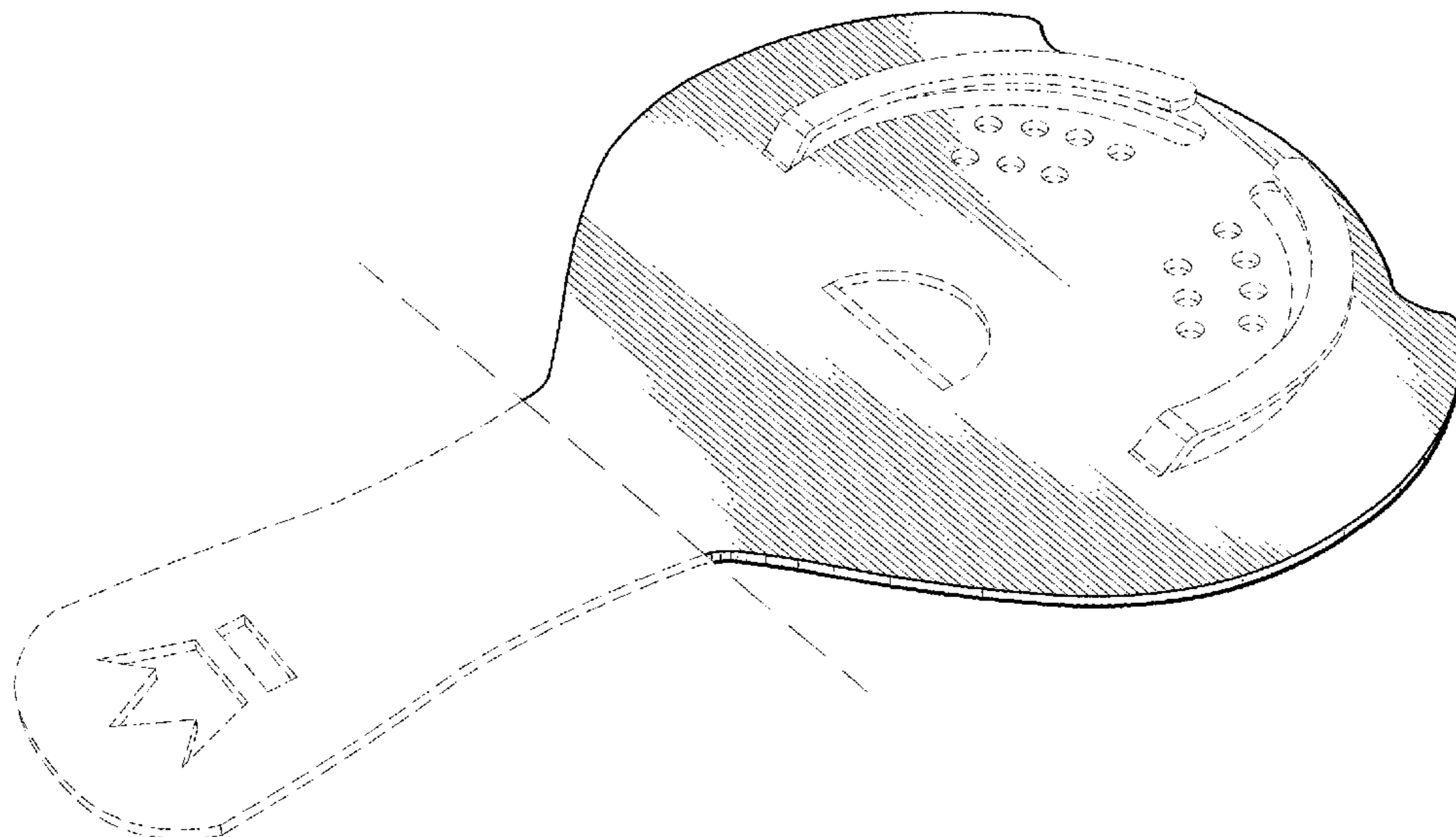

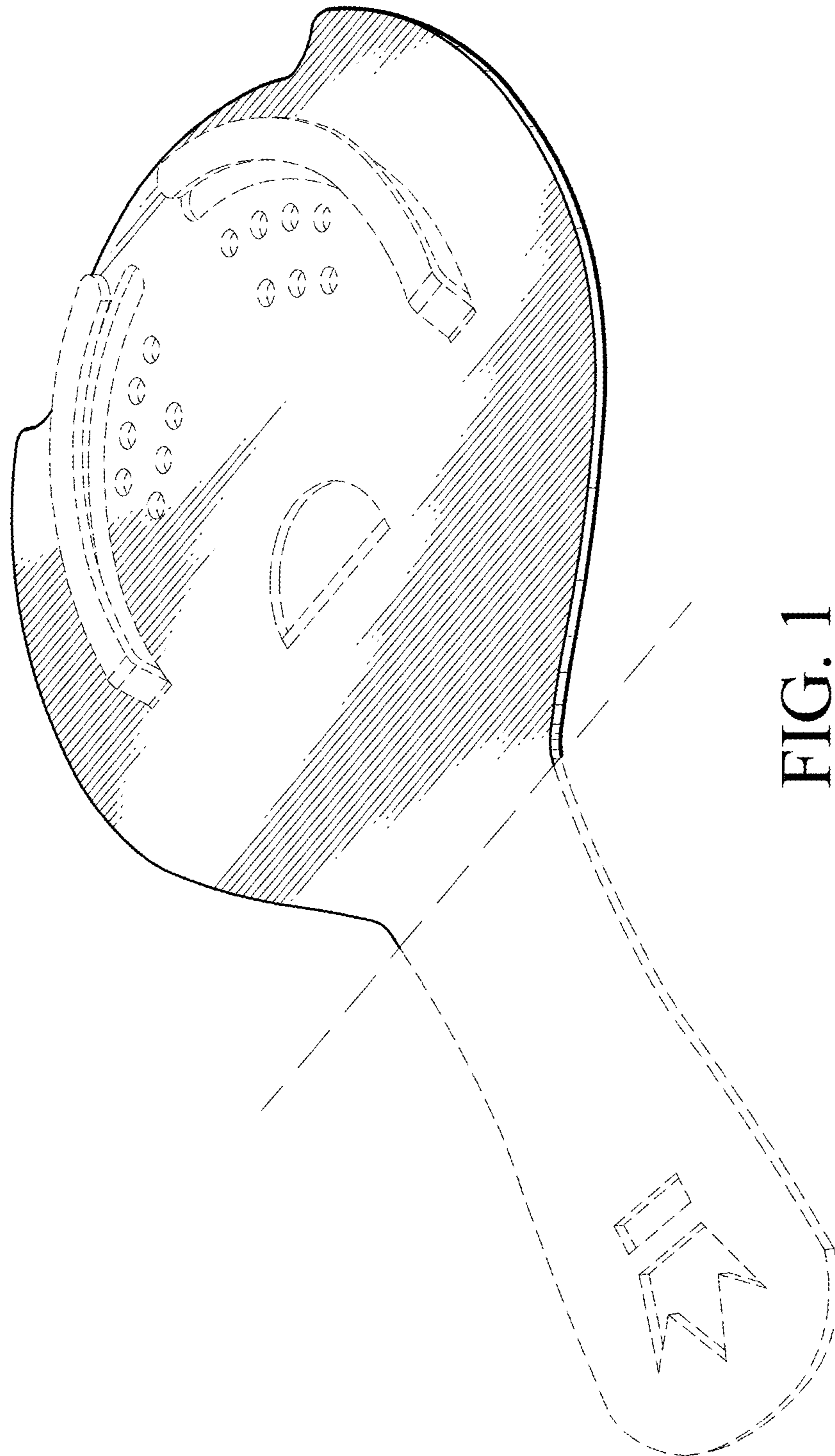

FIG. 1

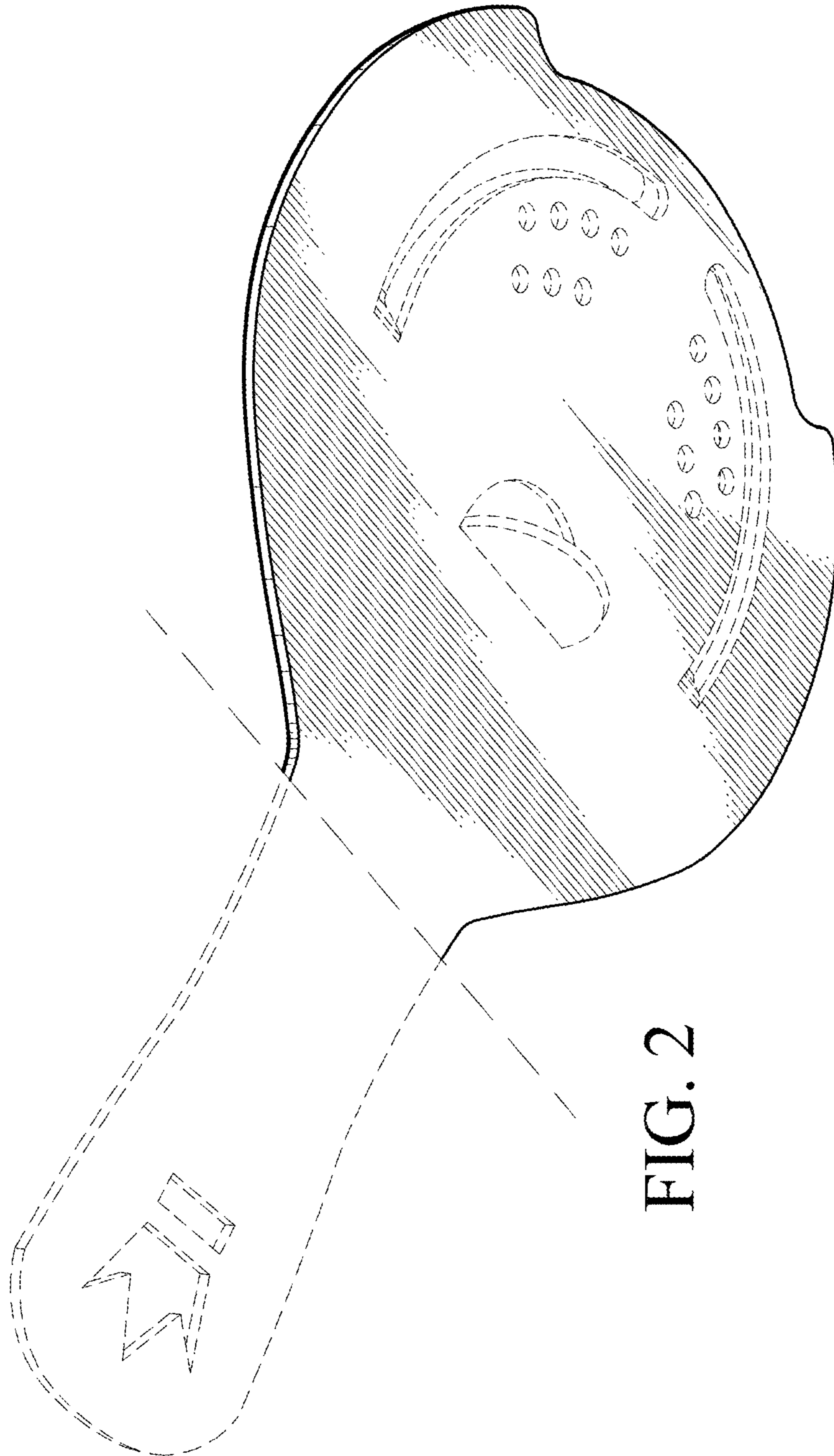

FIG. 2

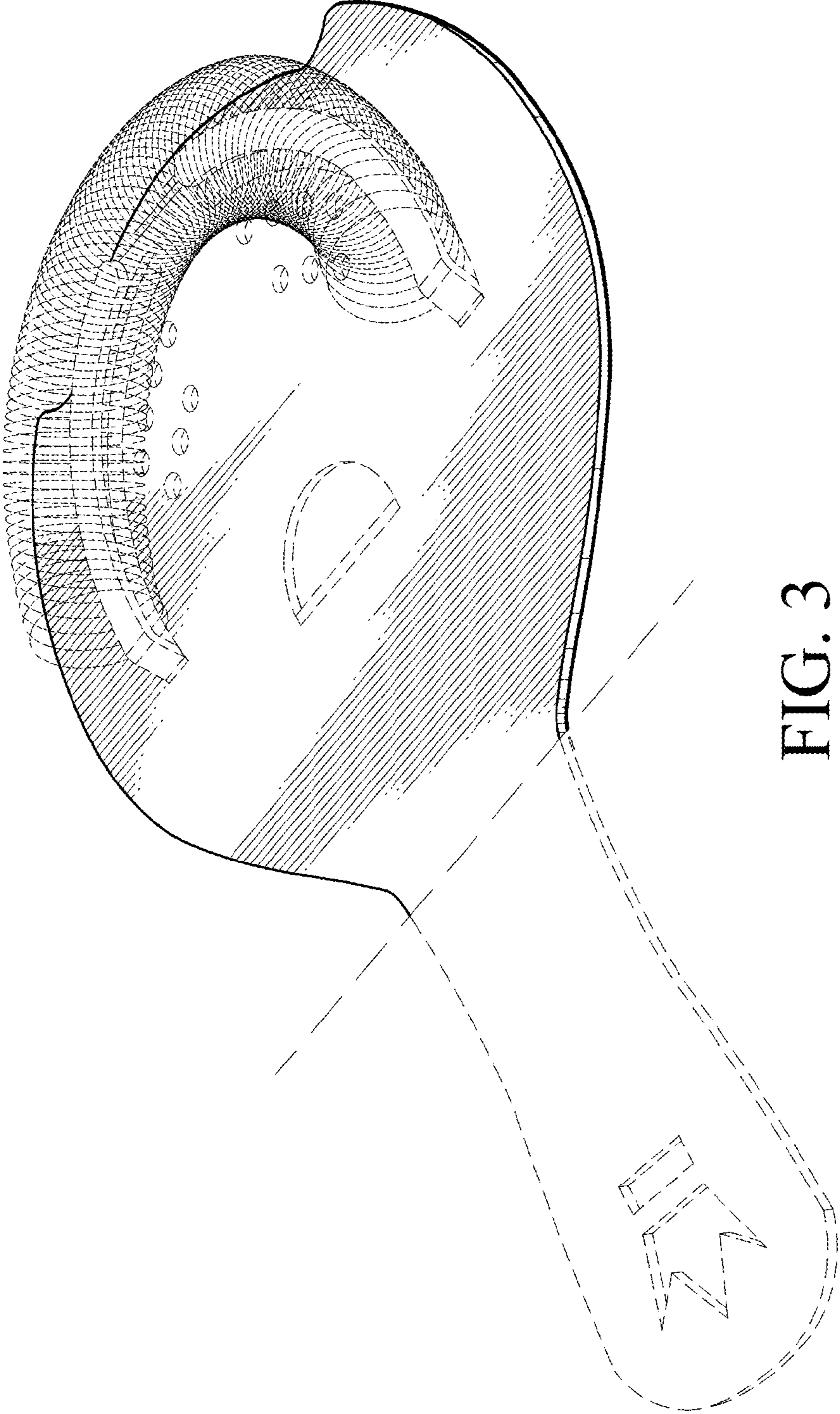

FIG. 3

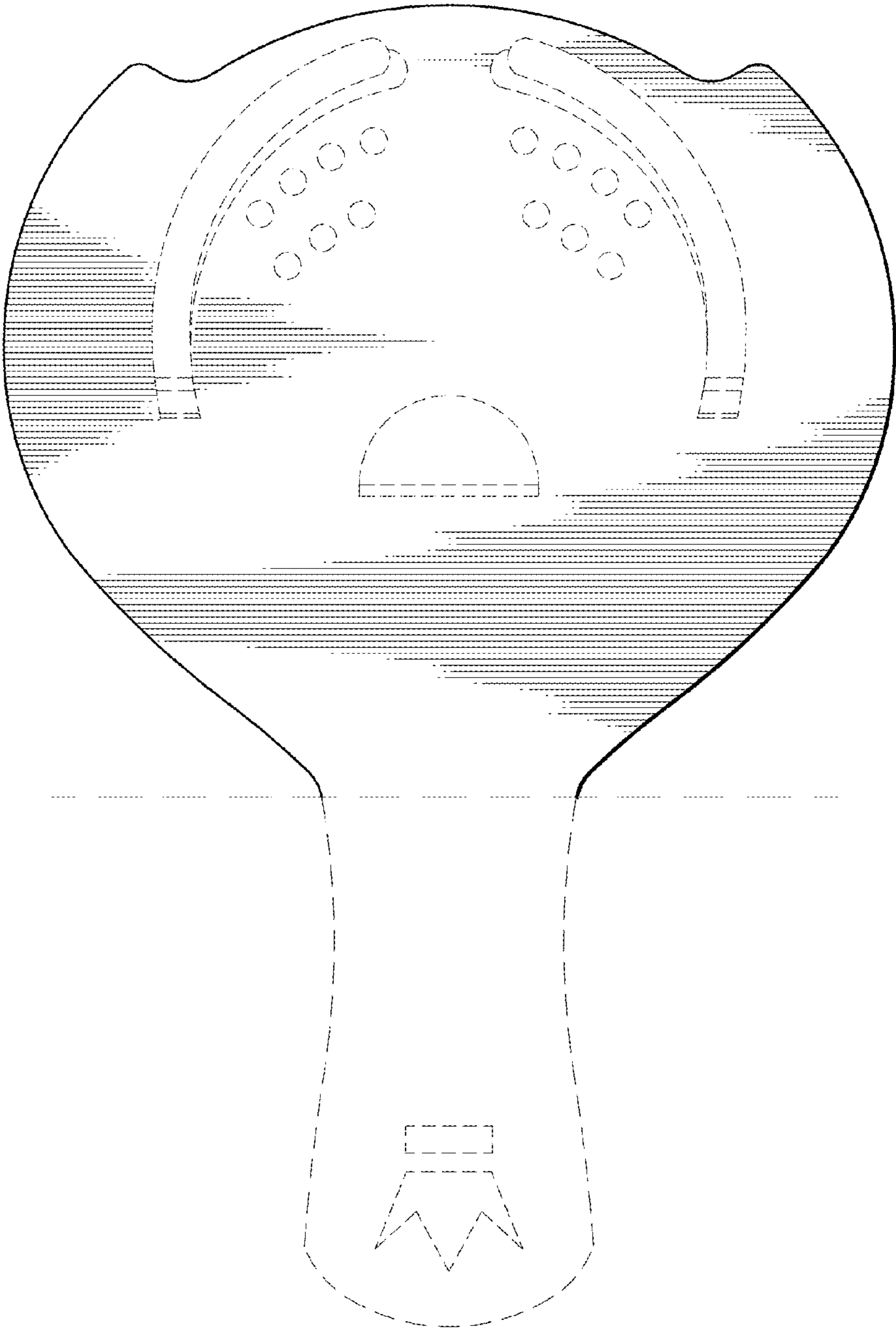

FIG. 4

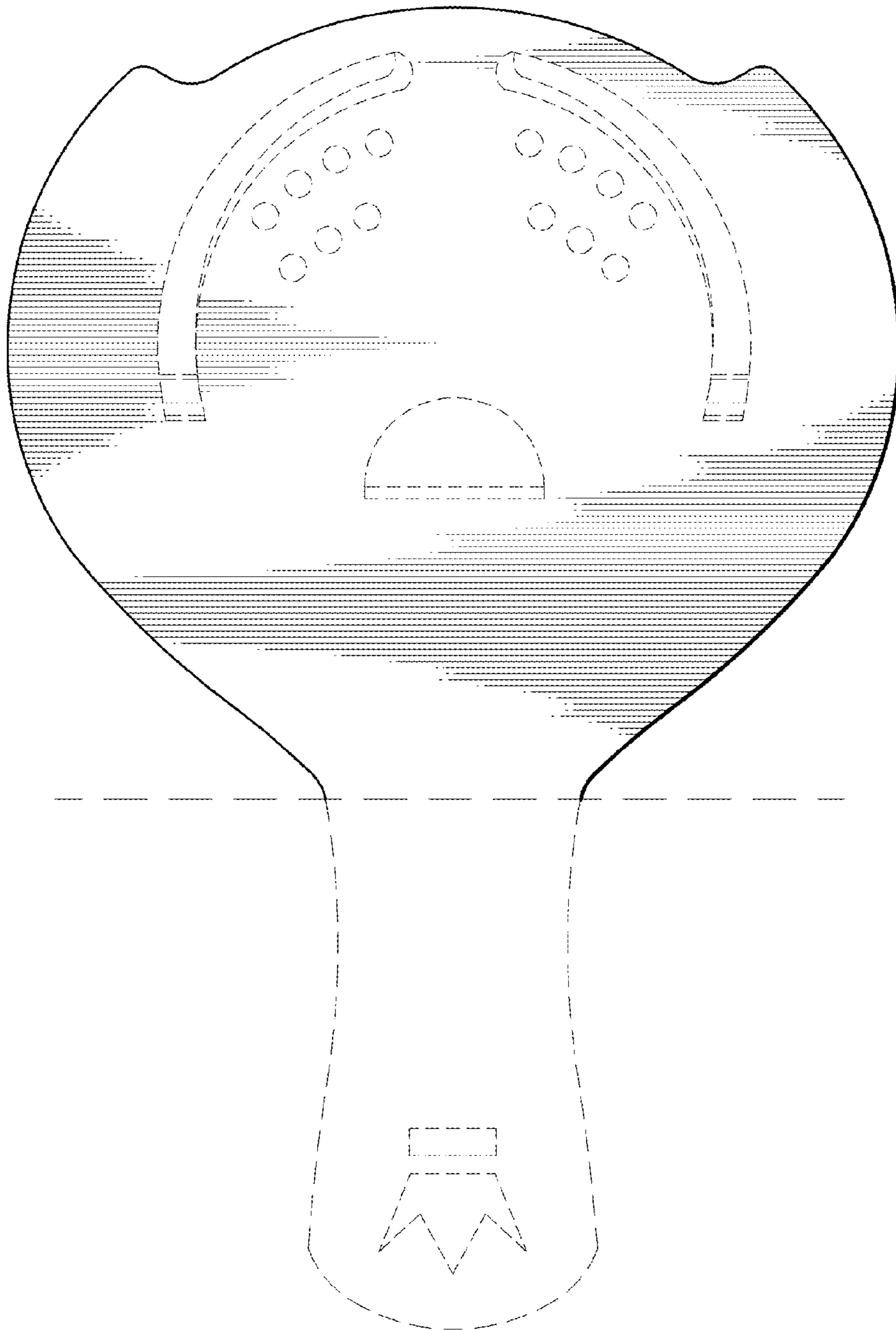

FIG. 5

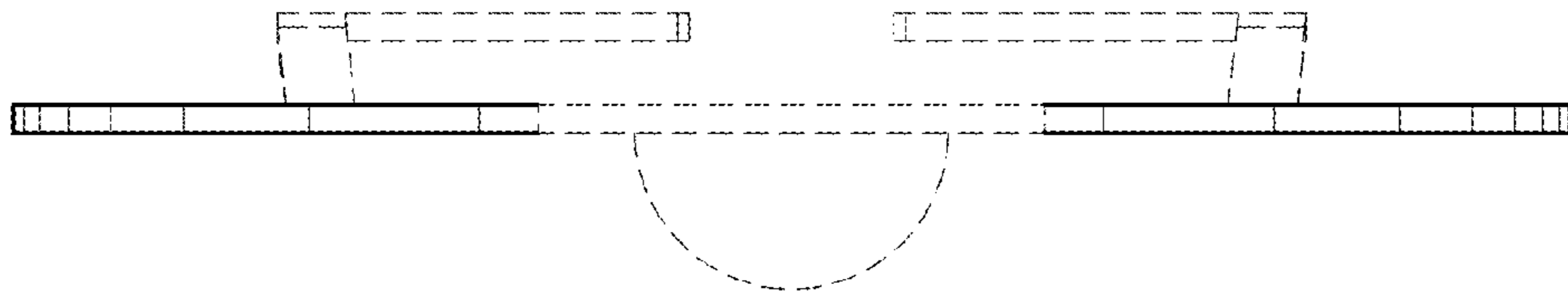

FIG. 6

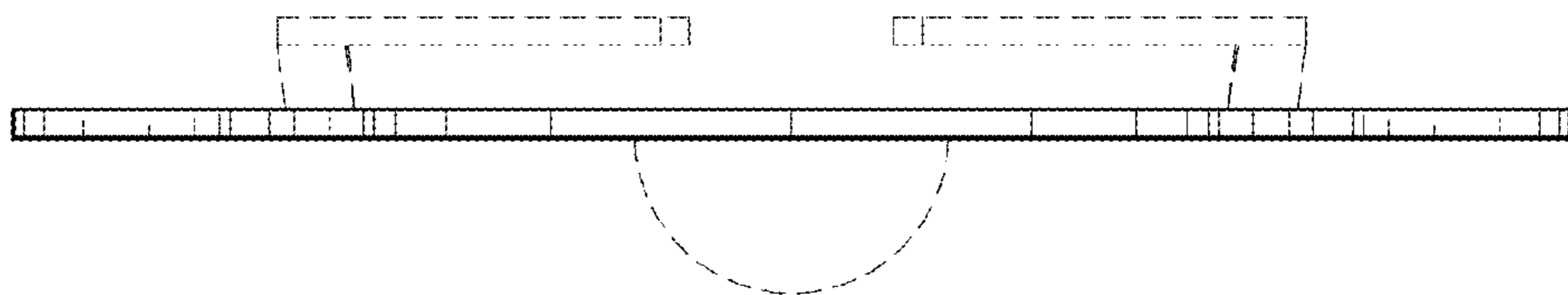

FIG. 7

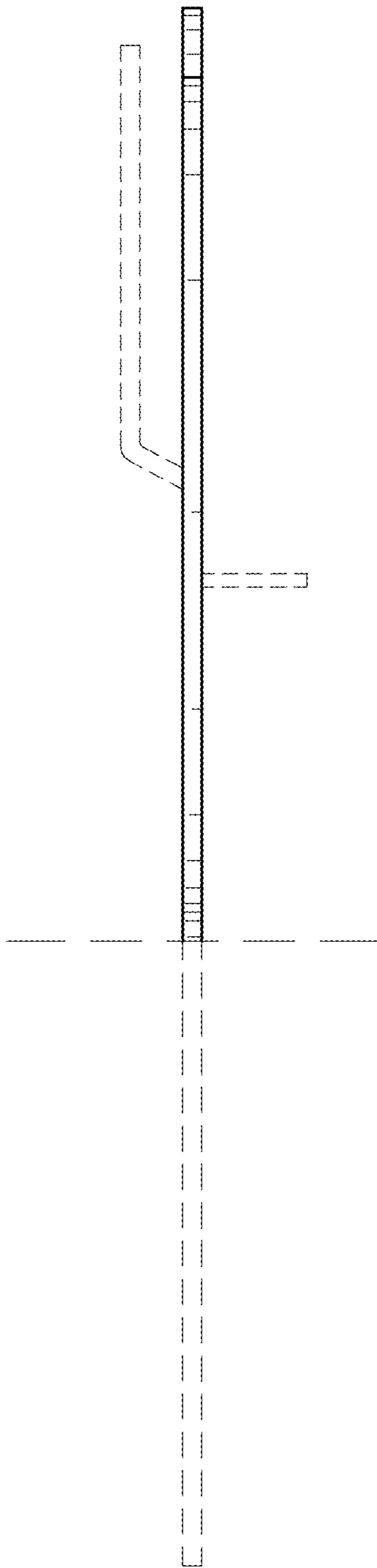

FIG. 8