



US00D734983S

(12) **United States Design Patent**
Doyle

(10) **Patent No.:** **US D734,983 S**
(45) **Date of Patent:** **** Jul. 28, 2015**

(54) **DETACHABLE HANDLE FOR COOKWARE**

(56) **References Cited**

(71) Applicant: **Michael Doyle**, Falmouth, ME (US)

U.S. PATENT DOCUMENTS

(72) Inventor: **Michael Doyle**, Falmouth, ME (US)

D200,489	S	*	3/1965	Munson	D7/395
D202,512	S	*	10/1965	Imhoff	D7/395
3,272,547	A	*	9/1966	Pryce	220/759
4,577,367	A	*	3/1986	Durand	220/759
D335,241	S	*	5/1993	Babin, Jr.	D7/395
D384,243	S	*	9/1997	Nicollet	D7/395
D542,608	S	*	5/2007	Romsburg et al.	D7/688
7,481,330	B2	*	1/2009	Lorthioir et al.	220/759
D613,992	S	*	4/2010	Seo	D7/395
7,883,129	B2	*	2/2011	Jung et al.	220/759
8,235,245	B2	*	8/2012	Lorthioir	220/759

(73) Assignee: **Michael Doyle**, Falmouth, ME (US)

(**) Term: **14 Years**

(21) Appl. No.: **29/495,274**

(22) Filed: **Jun. 30, 2014**

* cited by examiner

Related U.S. Application Data

Primary Examiner — Cynthia M Chin

(63) Continuation-in-part of application No. 29/459,218, filed on Jun. 27, 2013, now abandoned.

(74) *Attorney, Agent, or Firm* — Patricia M. Mathers

(51) **LOC (10) Cl.** **07-02**

(57) **CLAIM**

(52) **U.S. Cl.**

The ornamental design for a detachable handle for cookware, as shown and described.

USPC **D7/395**

DESCRIPTION

(58) **Field of Classification Search**

USPC D7/354–361, 393–395, 401.2, 664;
D8/107, 300, 303, 307, 313, 321;
D4/138, 129; 16/421, 430, 431, 110.1,
16/407; 220/573.1–573.5, 752, 753, 755,
220/756, 759, 767, 771, 912
CPC A47J 45/06; A47J 45/061; A47J 45/62;
A47J 45/08; A47J 45/085; A47J 45/071;
A47J 45/072; B65D 25/2802; B65D 25/2882;
B65D 25/2885; B65D 25/2888; B65D
25/2894; Y10S 220/912

FIG. 1 is a perspective view of the detachable handle, showing the upper face.
FIG. 2 is a bottom plan view of the detachable handle
FIG. 3 is an elevation plan view of the detachable handle, the right and left sides of the handle being mirror images.
FIG. 4 is a top plan view of the handle.
FIG. 5 is a front plan view of the handle; and,
FIG. 6 is a rear plan view of the handle.
The broken lines represent portions of the article that form no part of the claim.

See application file for complete search history.

1 Claim, 3 Drawing Sheets

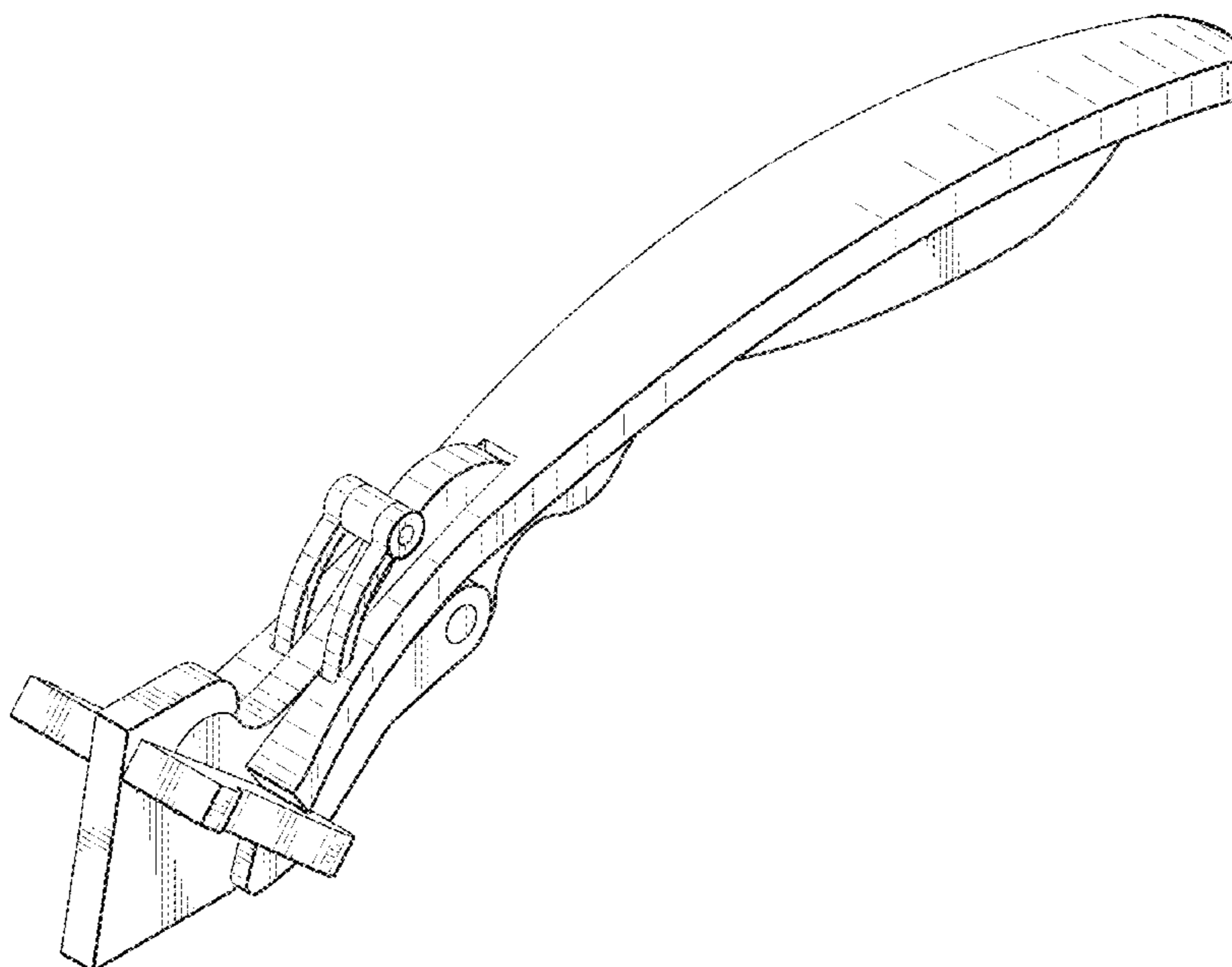

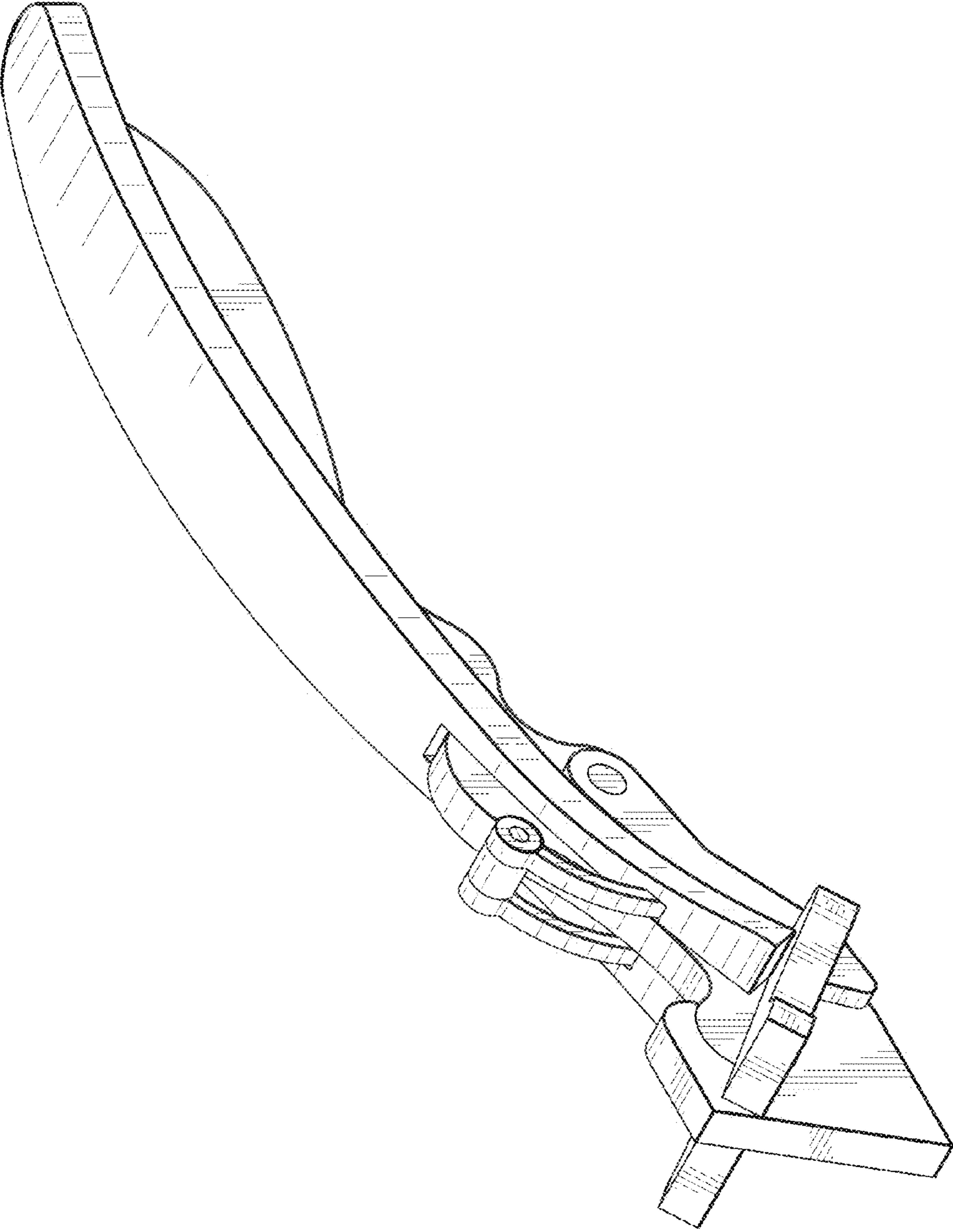

FIG. 1

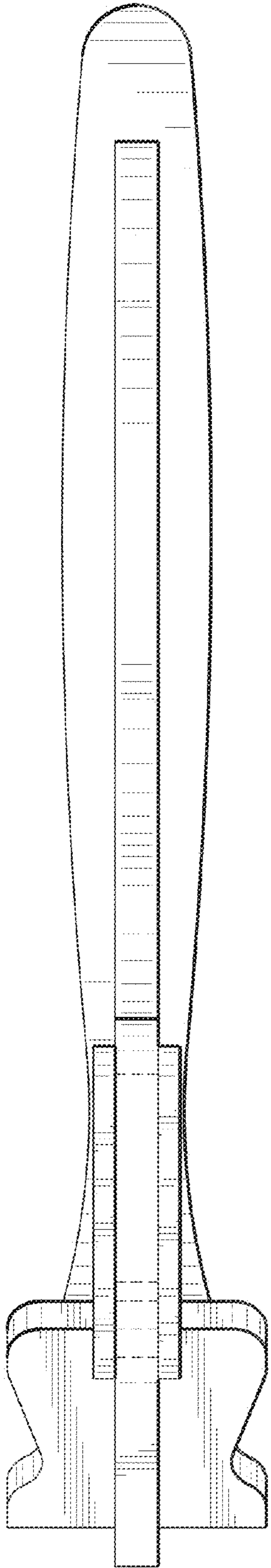

FIG. 2

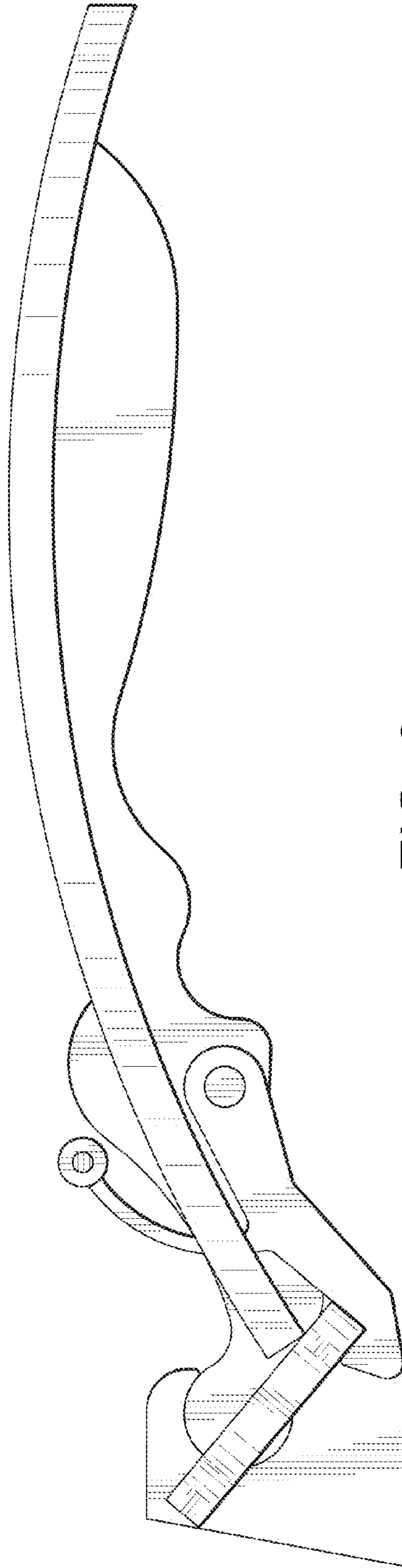

FIG. 3

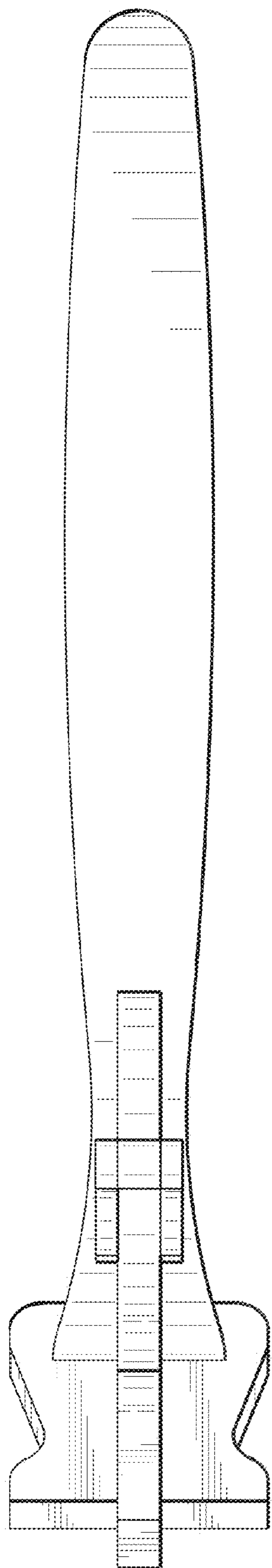

FIG. 4

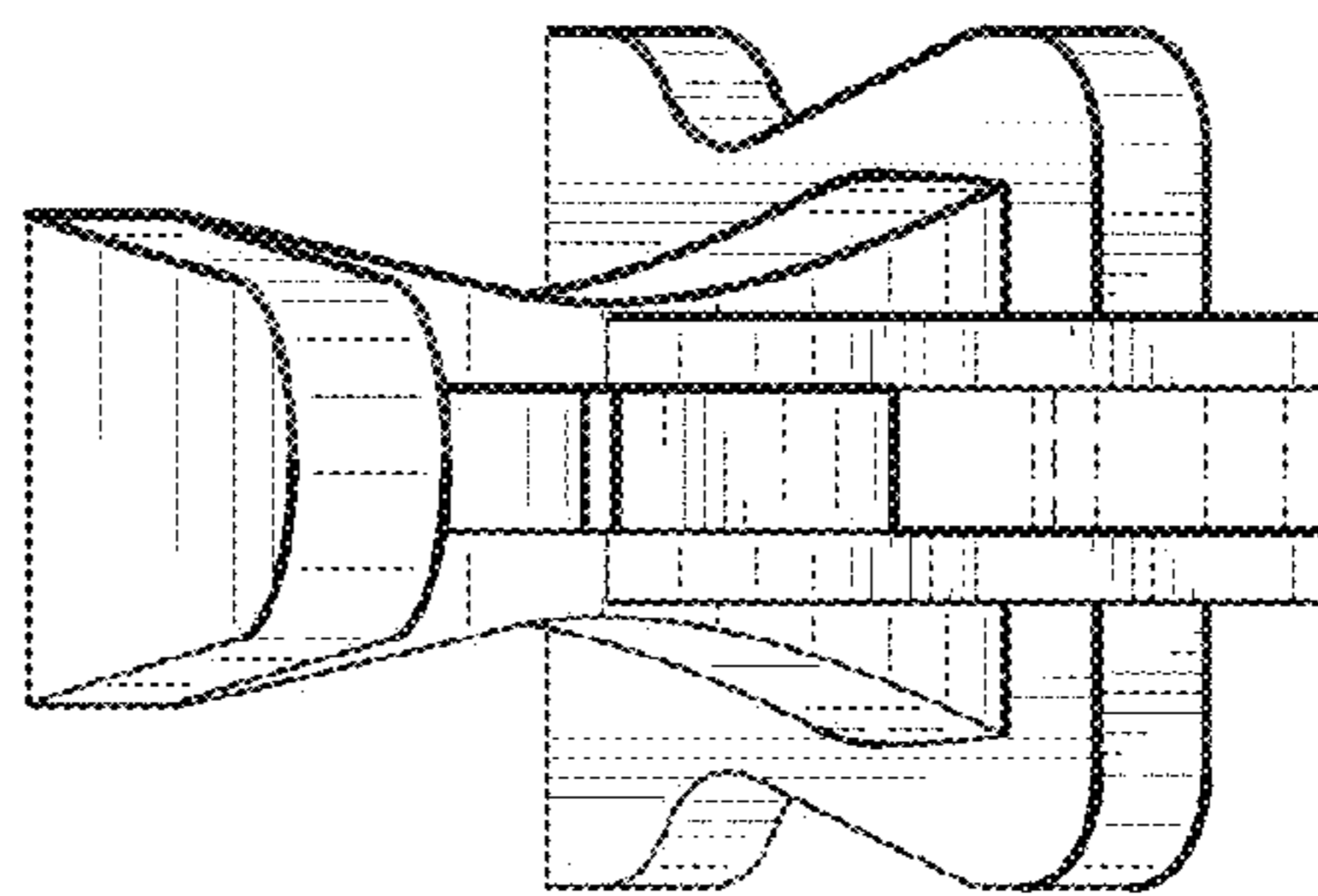

FIG. 6

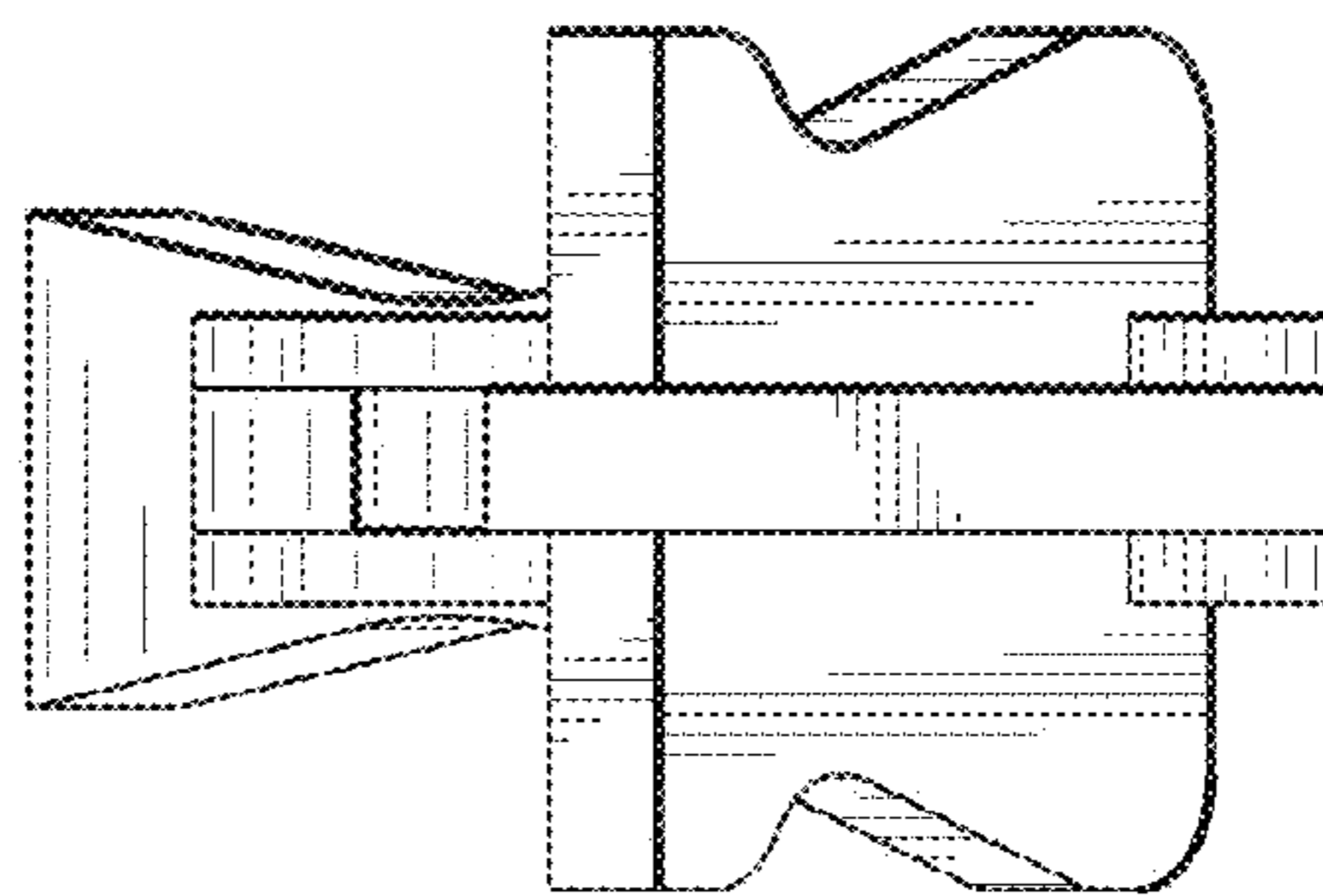

FIG. 5