



US00D734878S

(12) **United States Design Patent**
Nelson

(10) **Patent No.:** **US D734,878 S**
(45) **Date of Patent:** **** Jul. 21, 2015**

- (54) **ABOVE GROUND CONTAINMENT WALL CORNER SECTION**
- (71) Applicant: **Chris Nelson**, Harrisburg, SD (US)
- (72) Inventor: **Chris Nelson**, Harrisburg, SD (US)
- (**) Term: **14 Years**
- (21) Appl. No.: **29/477,275**
- (22) Filed: **Dec. 20, 2013**
- (51) **LOC (10) Cl.** **25-01**
- (52) **U.S. Cl.**
USPC **D25/164**
- (58) **Field of Classification Search**
USPC D5/1, 2, 3, 44, 58, 60, 99; D6/332;
D25/58, 113, 114, 115, 136, 138, 139,
D25/140-144, 153, 156, 157, 159, 163, 164,
D25/199
CPC A01G 1/08; E01C 11/221; E01C 11/222;
E01C 11/22; E02D 5/803; E02D 5/805;
E04H 12/182; H01Q 1/103
See application file for complete search history.

(56) **References Cited**

U.S. PATENT DOCUMENTS

3,222,838	A *	12/1965	Sweeney	296/41
3,277,606	A *	10/1966	Cohen	47/33
4,831,776	A *	5/1989	Fritch	47/33
5,377,447	A *	1/1995	Fritch	47/33
D372,969	S *	8/1996	Hicks	D23/393
D457,972	S *	5/2002	Harel	D25/121
D489,832	S *	5/2004	Koenig et al.	D25/136

D574,520	S *	8/2008	Taylor et al.	D25/121
8,661,751	B1 *	3/2014	Lawrie et al.	52/288.1
2008/0163566	A1 *	7/2008	Bella	52/102
2010/0050505	A1 *	3/2010	Zwier	47/33
2015/0016870	A1 *	1/2015	Arnold	403/266
2015/0052845	A1 *	2/2015	Desautels et al.	52/650.3

* cited by examiner

Primary Examiner — Karen S Acker
Assistant Examiner — Amy Wierenga

(57) **CLAIM**

The ornamental design for an above ground containment wall corner section, as shown and described.

DESCRIPTION

FIG. 1 is a front view of an above ground containment wall corner section showing my new design;
 FIG. 2 is a rear view of the above ground containment wall corner section;
 FIG. 3 is an enlarged top view of the above ground containment wall corner section;
 FIG. 4 is a left side view of the above ground containment wall corner section;
 FIG. 5 is a bottom perspective view of the above ground containment wall corner section;
 FIG. 6 is a top perspective view of the above ground containment wall corner section in a position of use. The broken lines depict environmental subject matter that forms no part of the claimed design; and,
 FIG. 7 is a left direct edge on view of the above ground containment wall corner section.

1 Claim, 6 Drawing Sheets

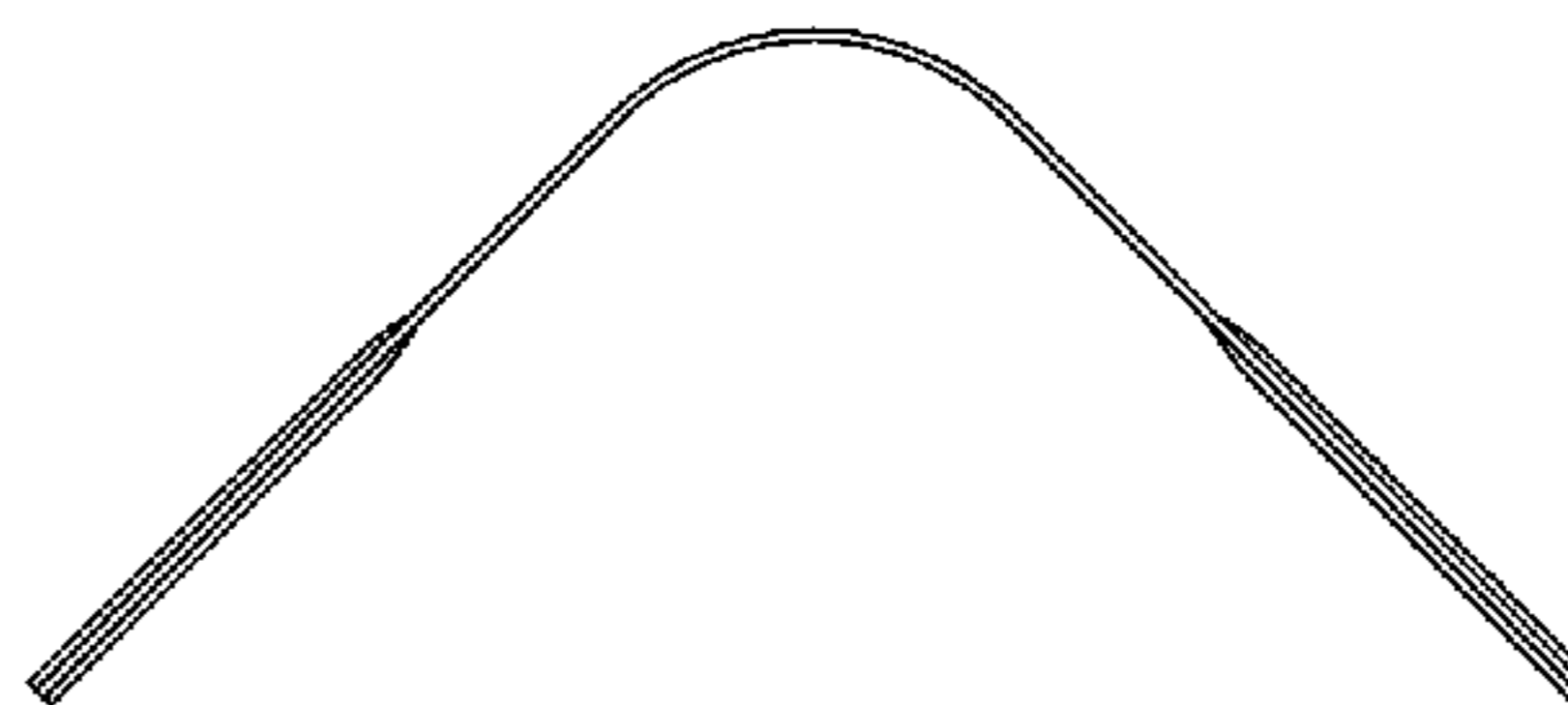
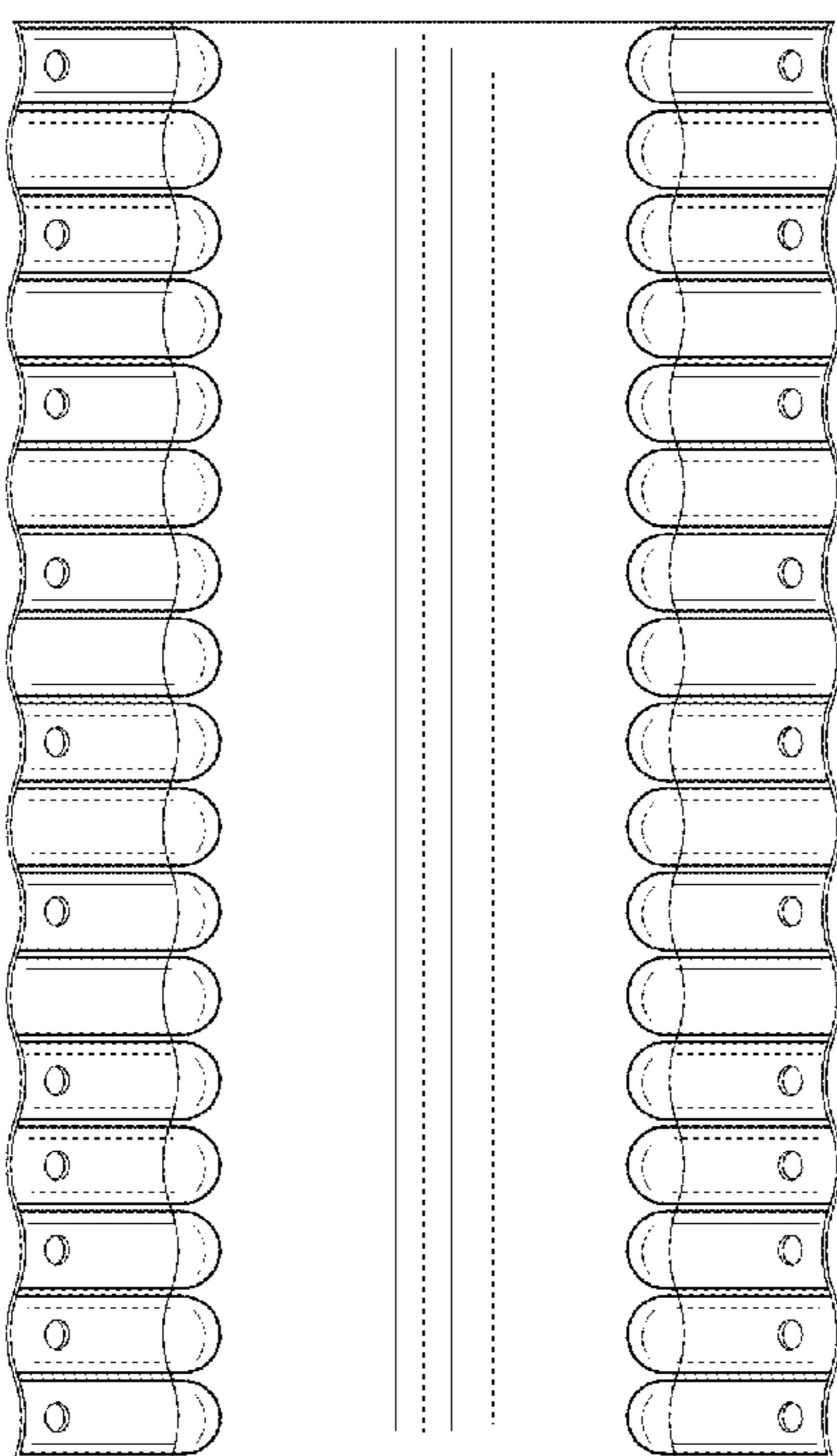

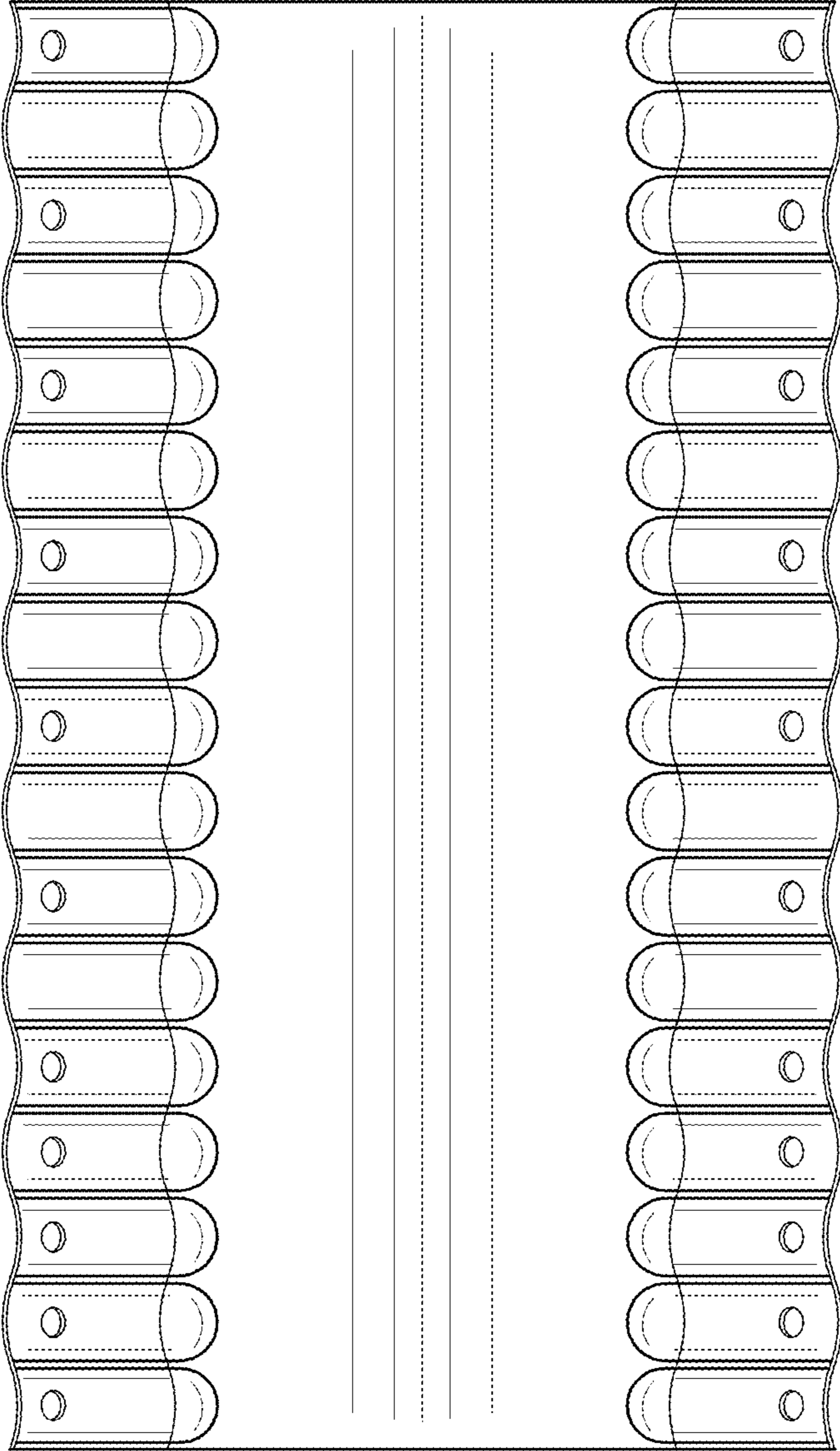

FIG. 1

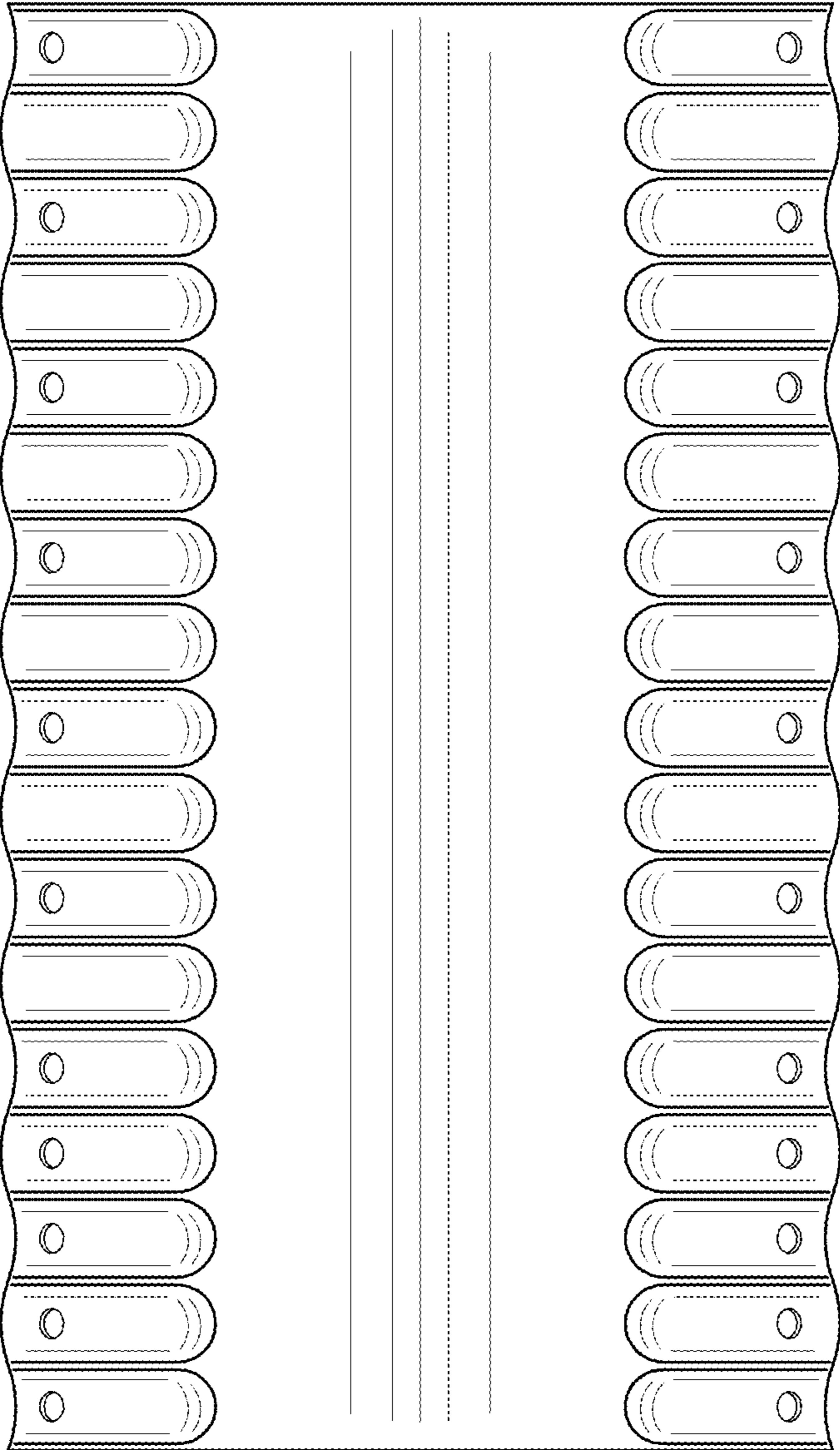

FIG. 2

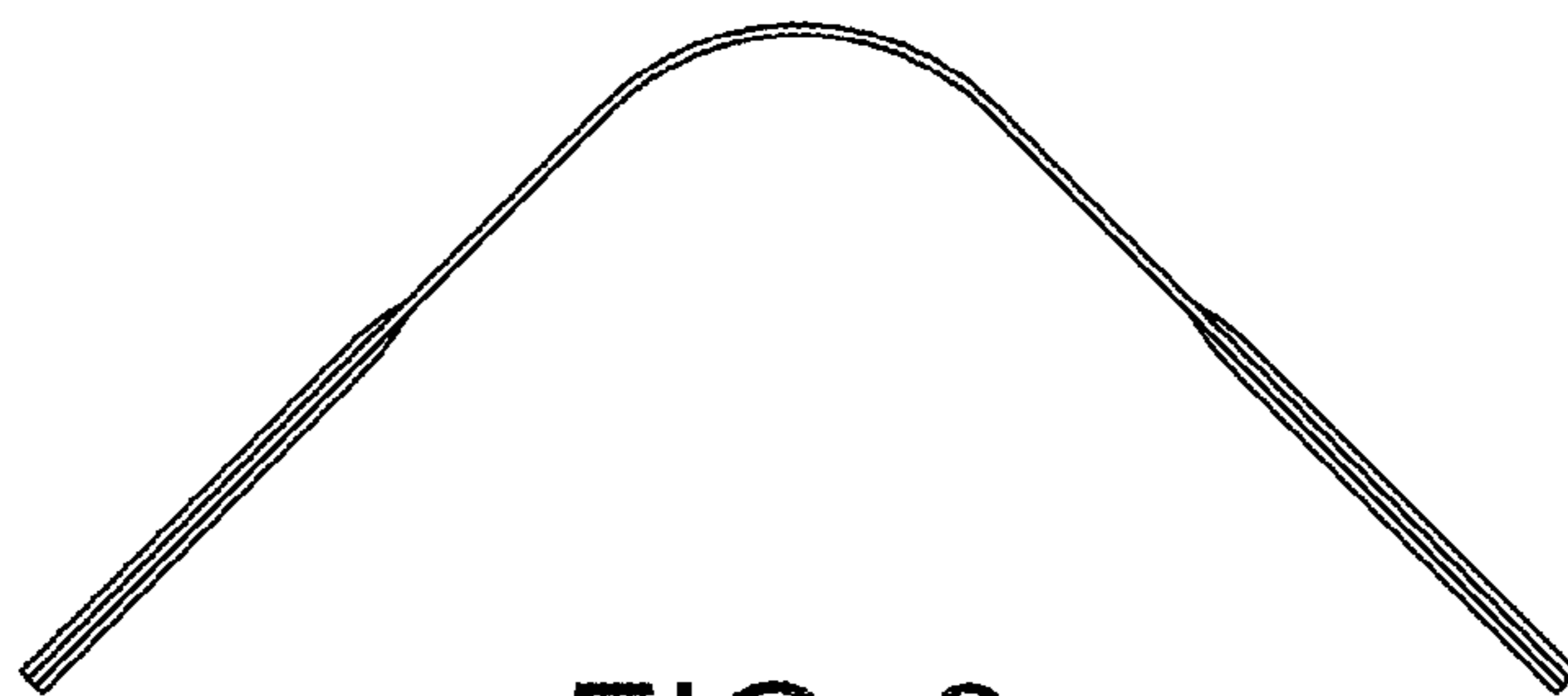

FIG. 3

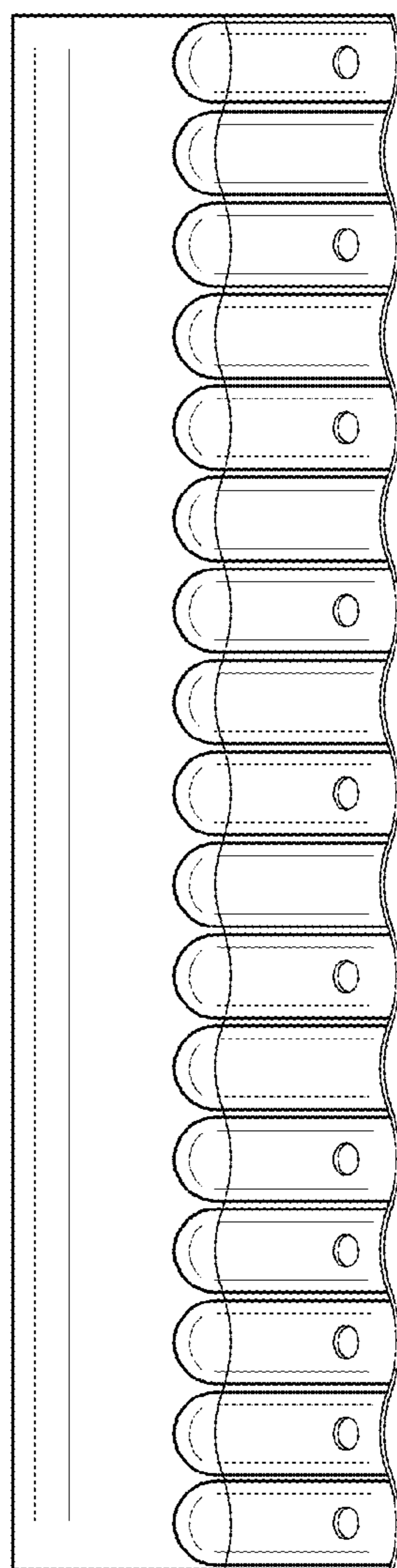

FIG. 4

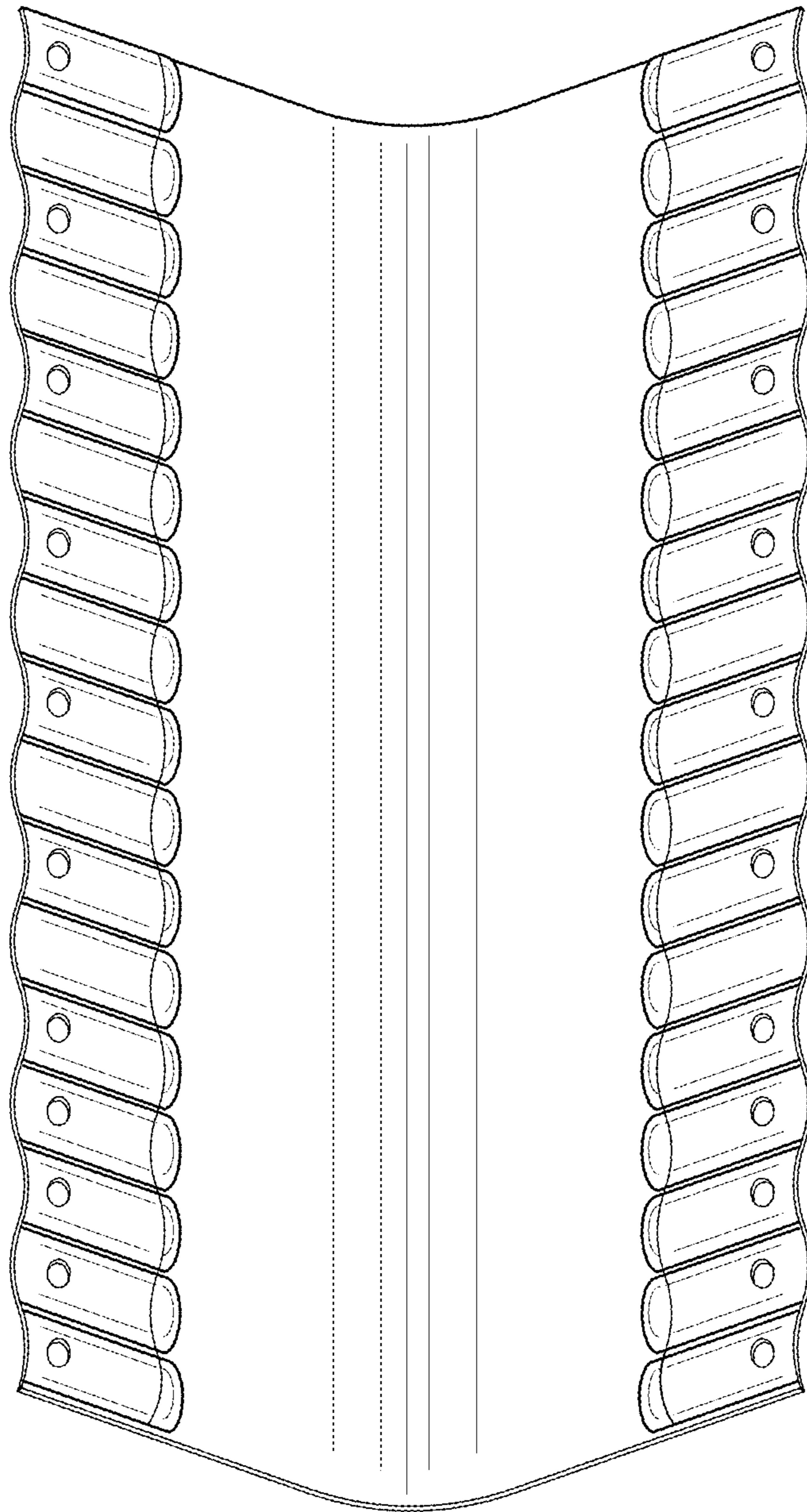

FIG. 5

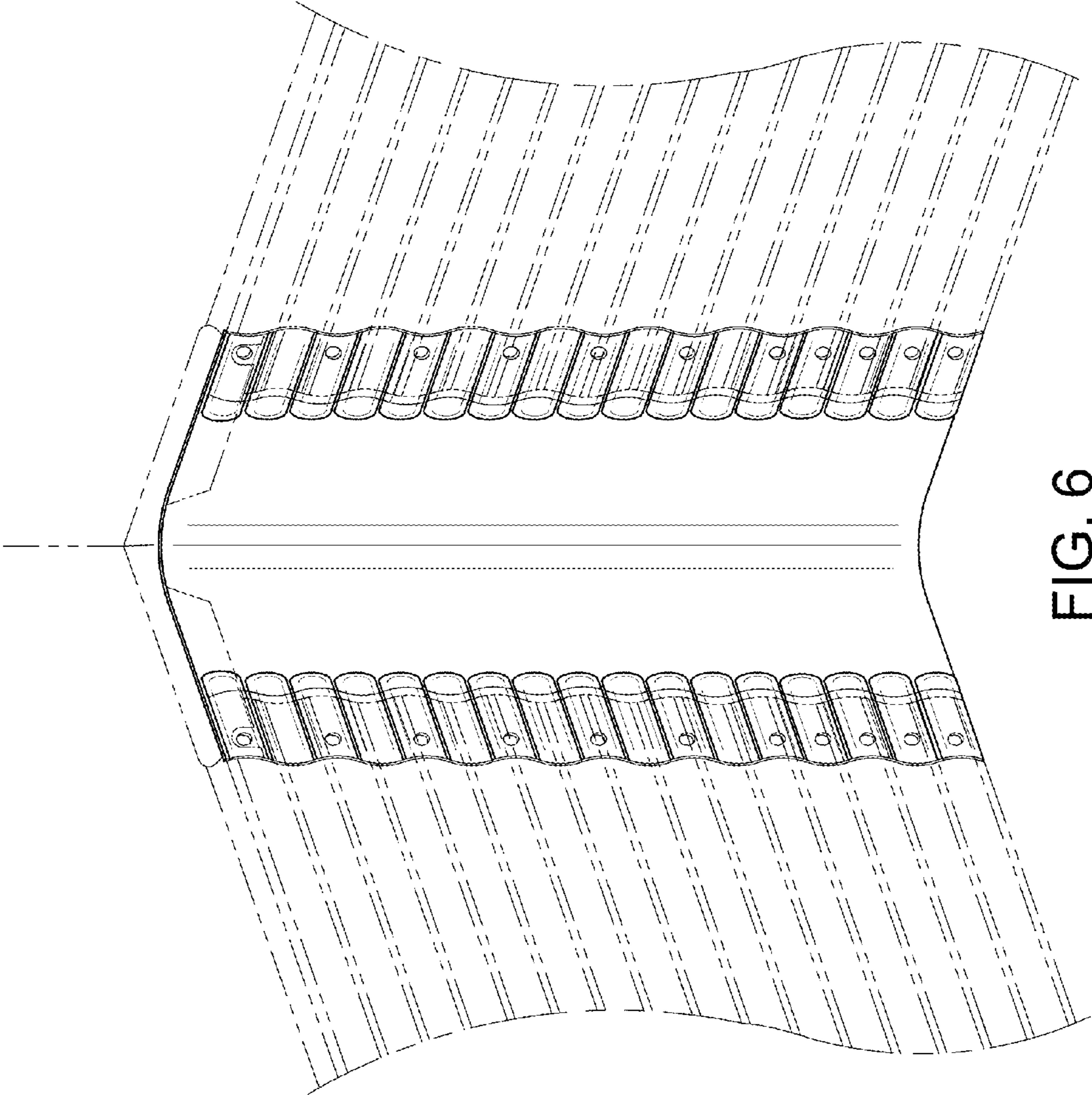

FIG. 6

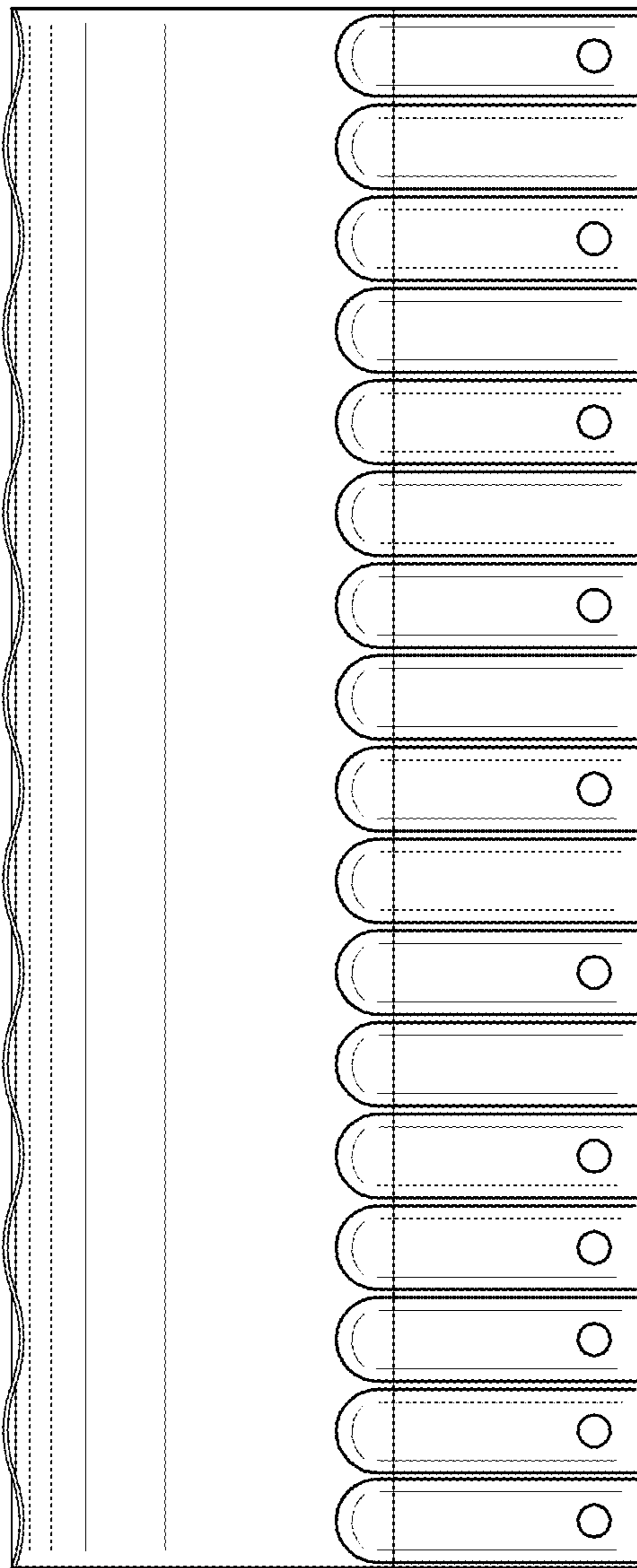

FIG. 7