



US00D734807S

(12) **United States Design Patent**
Wu

(10) **Patent No.:** **US D734,807 S**
(45) **Date of Patent:** **** Jul. 21, 2015**

(54) **EYEGLASSES WITH BLUETOOTH FOR PHONE AND MUSIC**

(71) Applicant: **Bowen Wu**, Shenzhen (CN)

(72) Inventor: **Bowen Wu**, Shenzhen (CN)

(**) Term: **14 Years**

(21) Appl. No.: **29/469,755**

(22) Filed: **Oct. 14, 2013**

(51) **LOC (10) Cl.** **16-06**

(52) **U.S. Cl.**
USPC **D16/309**; D16/306; D16/326

(58) **Field of Classification Search**
USPC D16/101, 300–342, 900; D29/109–110;
351/41, 44, 51–52, 62, 158, 92,
351/103–123, 140–153, 63, 59, 45–46;
2/426–432, 447–449, 441, 434–437,
2/13, 15; D21/483, 659–661; D14/372
CPC G02C 2200/08; G02C 1/06
See application file for complete search history.

(56) **References Cited**

U.S. PATENT DOCUMENTS

5,781,272 A * 7/1998 Bright et al. 351/123
D426,845 S * 6/2000 Green et al. D16/309

D462,708 S * 9/2002 Miller et al. D16/309
6,729,726 B2 * 5/2004 Miller et al. 351/158
D514,613 S * 2/2006 Jannard et al. D16/309
D553,173 S * 10/2007 Baden et al. D16/309
7,278,734 B2 * 10/2007 Jannard et al. 351/158
D611,980 S * 3/2010 Chen D16/309
D694,805 S * 12/2013 Cheng et al. D16/309
2003/0068057 A1 * 4/2003 Miller et al. 381/334

* cited by examiner

Primary Examiner — Raphael Barkai

(74) *Attorney, Agent, or Firm* — Troutman Sanders LLP

(57) **CLAIM**

The ornamental design for eyeglasses with bluetooth for phone and music, as shown and described.

DESCRIPTION

FIG. 1 is a top view of the eyeglasses with bluetooth for phone and music of the new design;
FIG. 2 is a bottom view thereof;
FIG. 3 is a front view thereof;
FIG. 4 is a left side view thereof;
FIG. 5 is a right view thereof; and,
FIG. 6 is a rear view thereof.

1 Claim, 6 Drawing Sheets

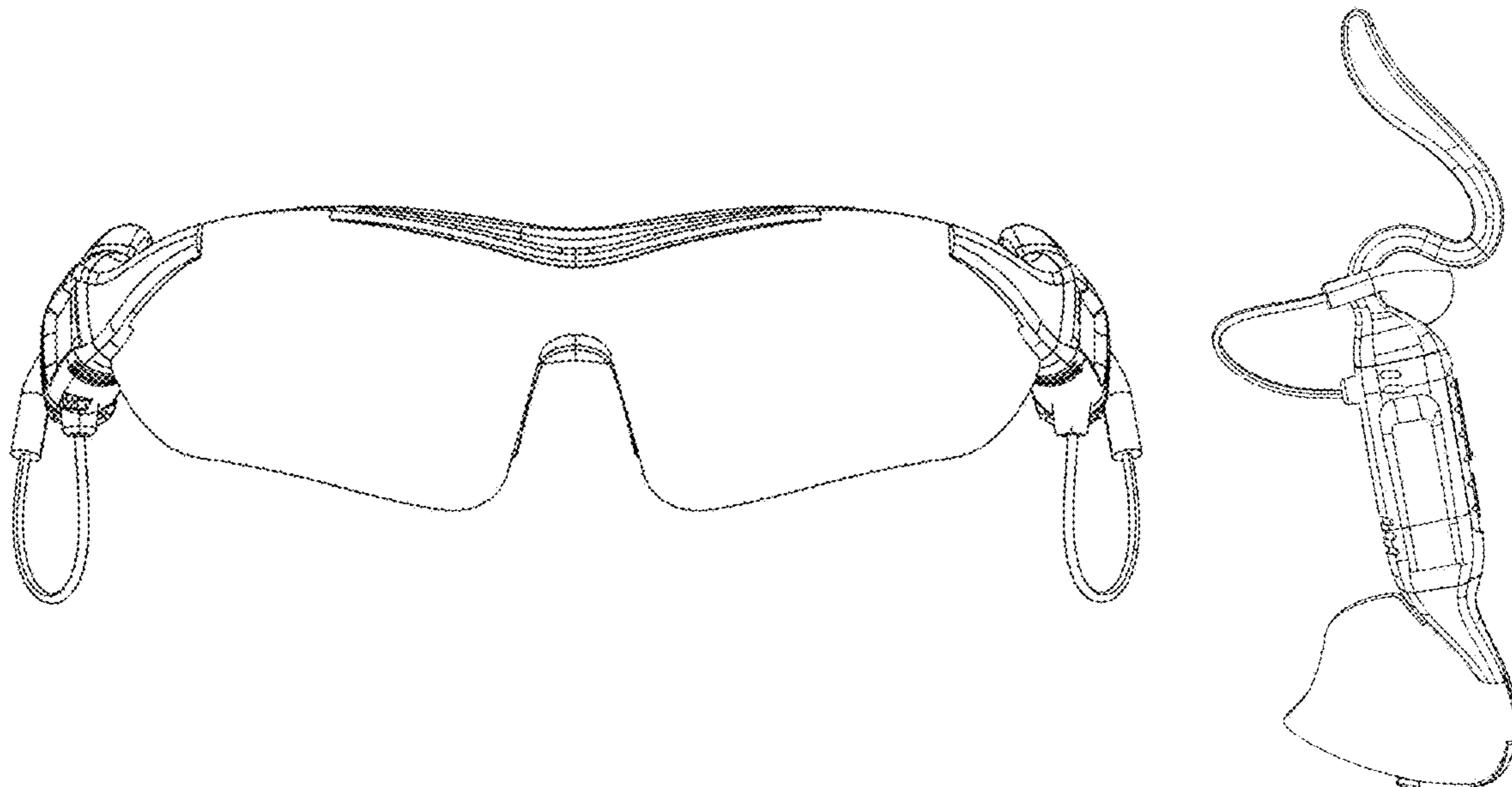

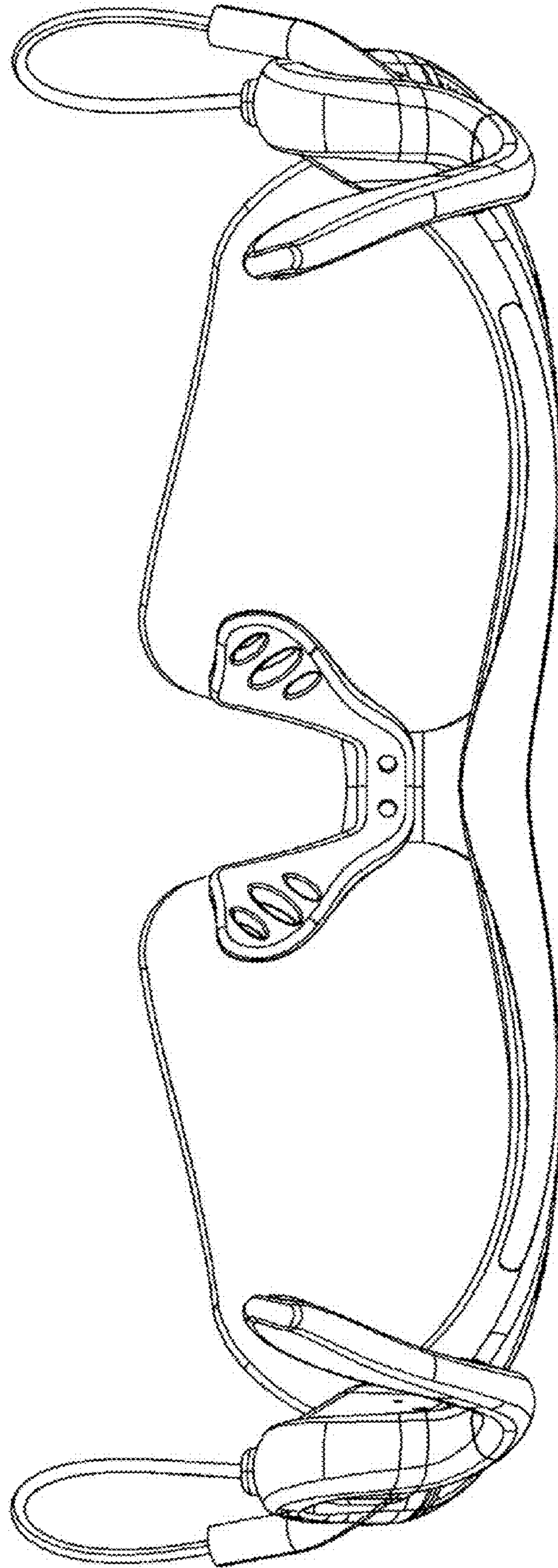

FIG. 1

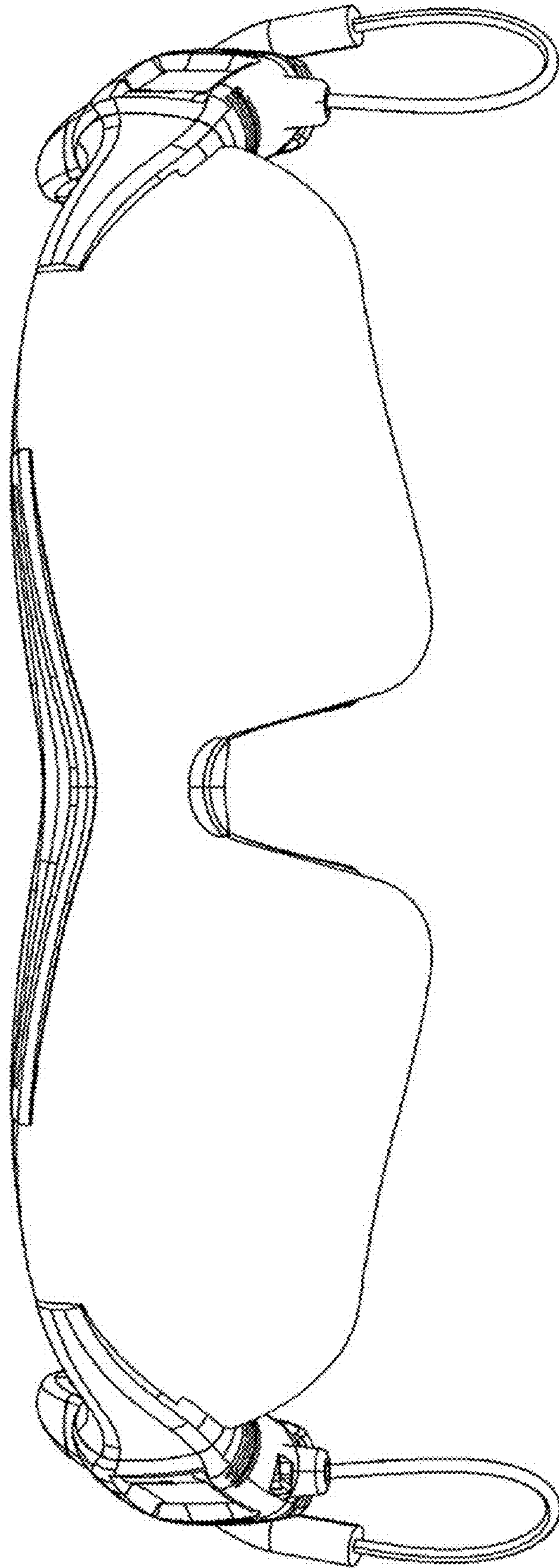

FIG. 2

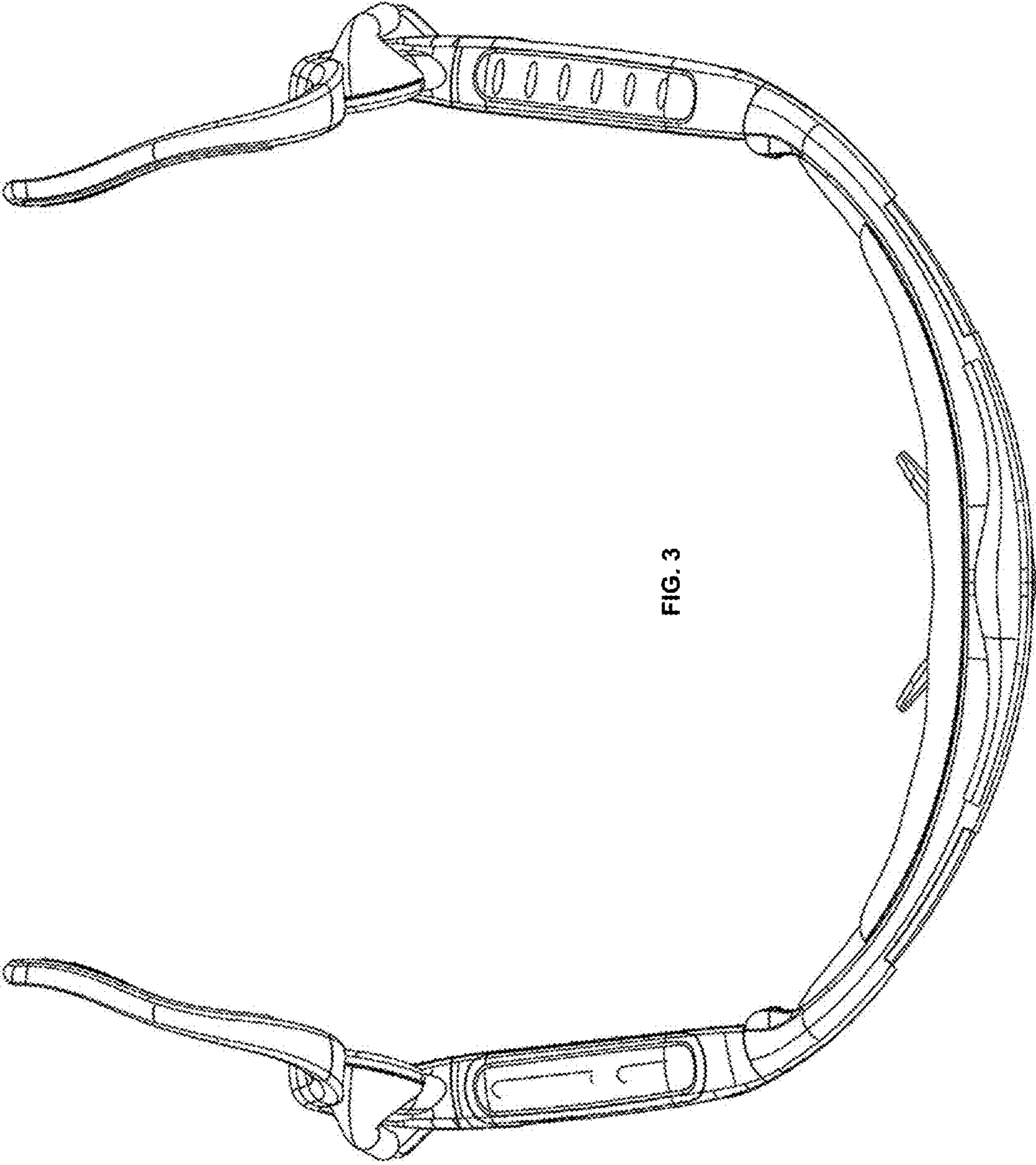
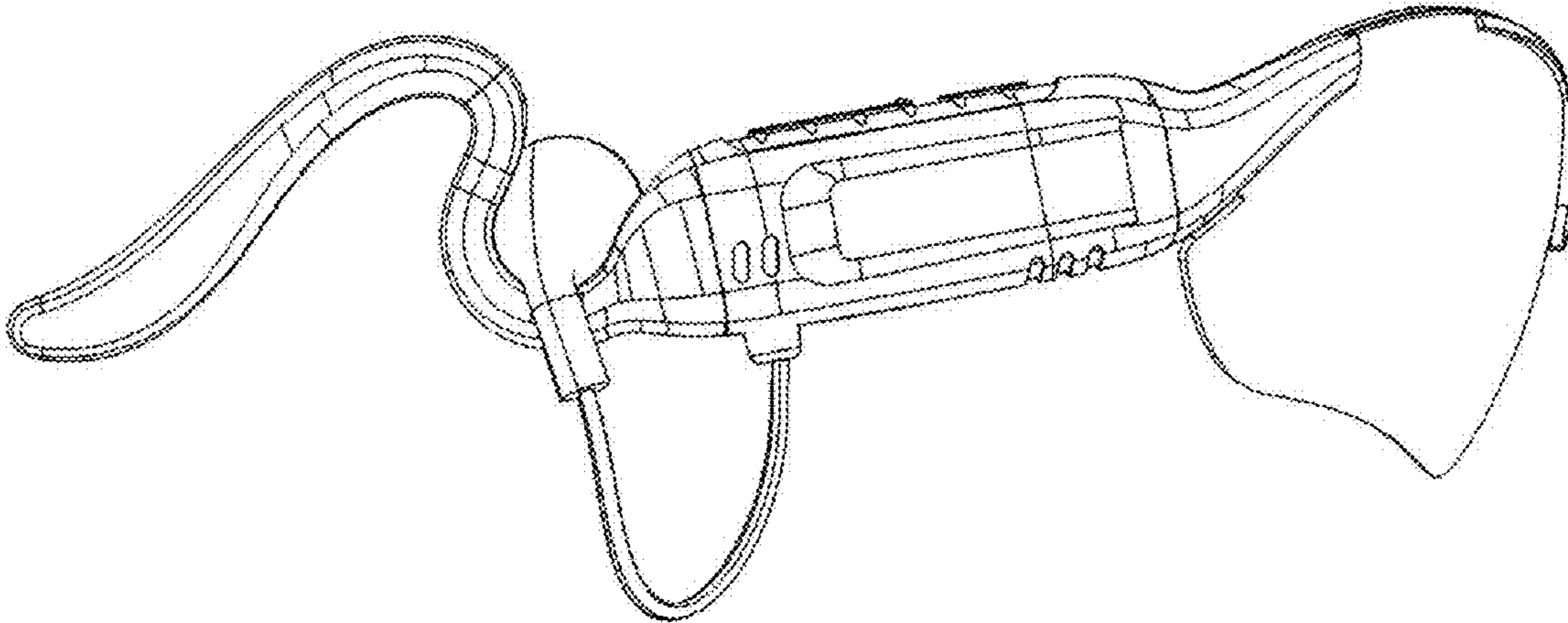

FIG. 3

FIG. 4



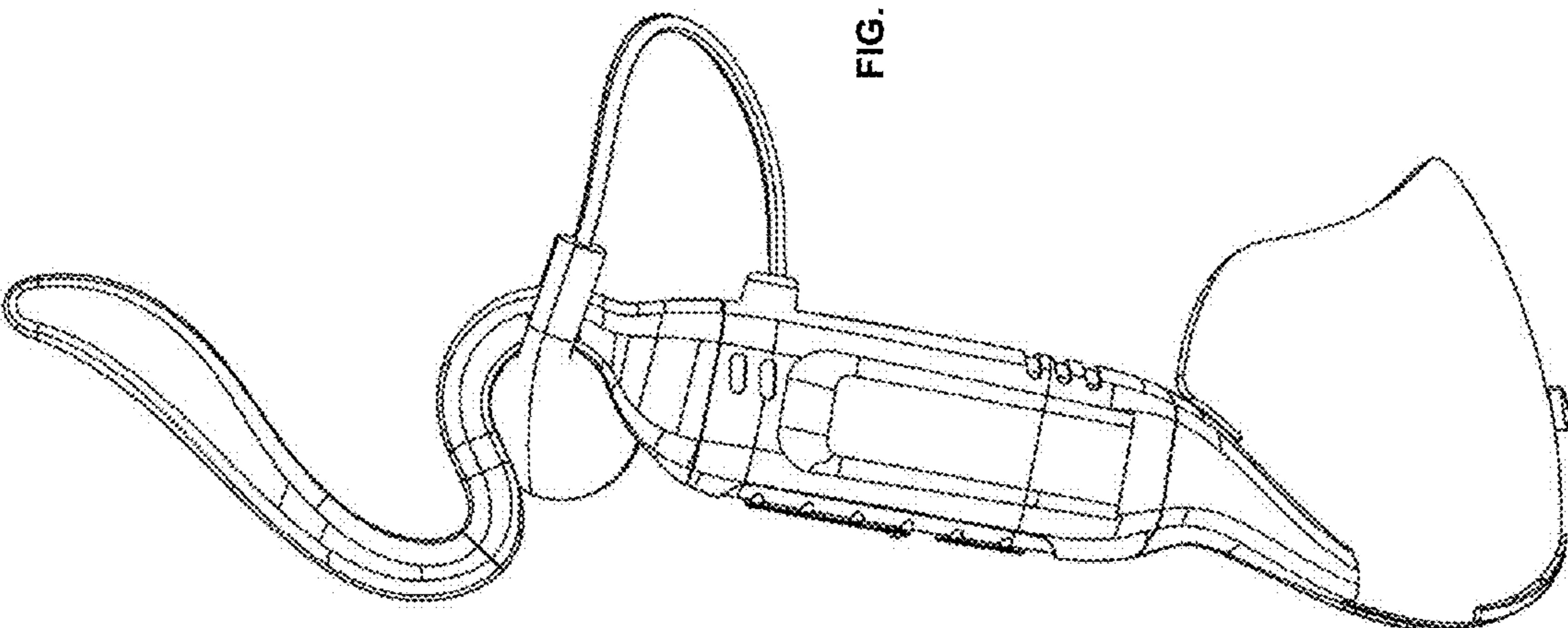

FIG. 5

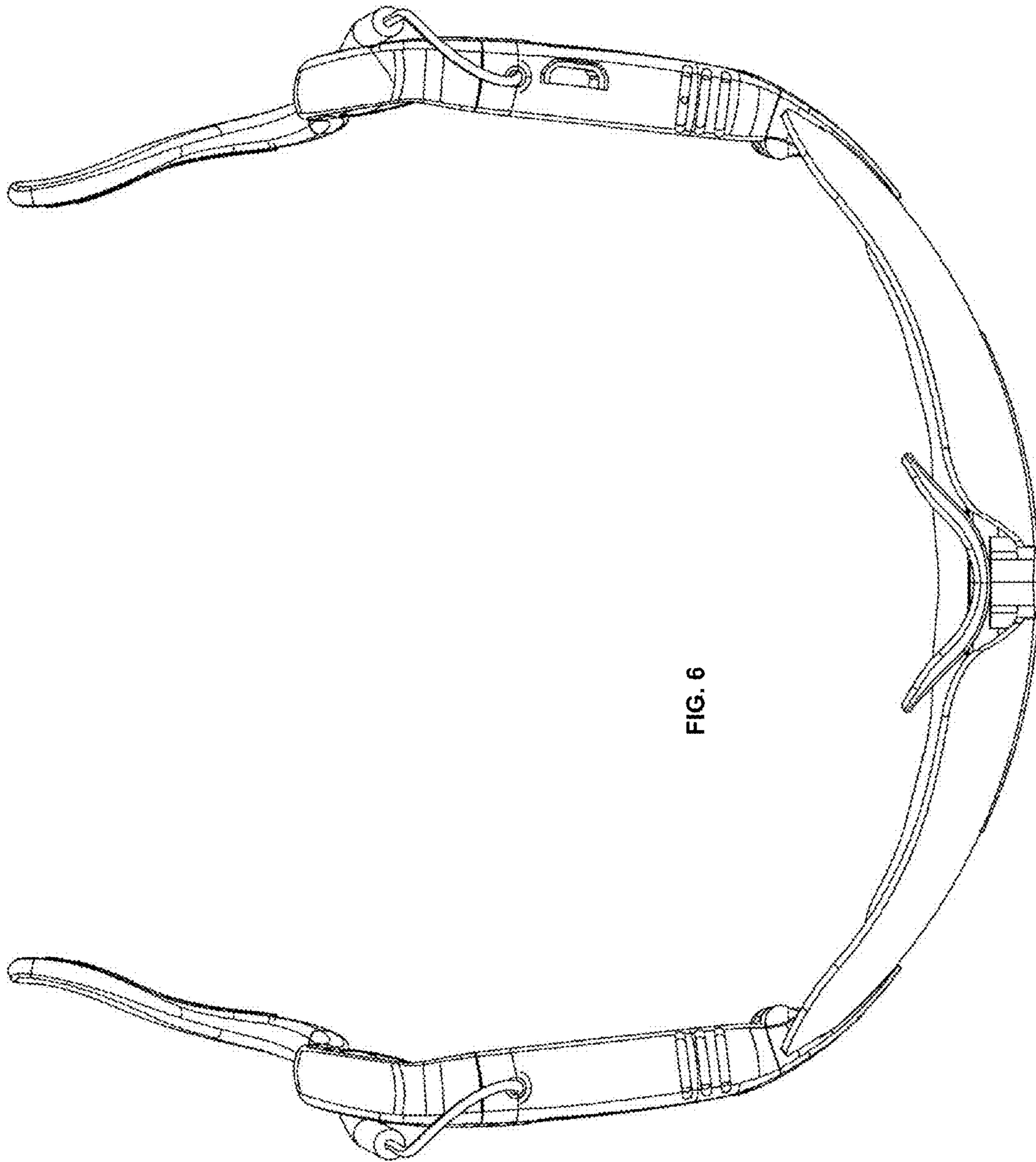

FIG. 6