

US00D734612S

(12) **United States Design Patent**
Liu

(10) **Patent No.:** **US D734,612 S**
(45) **Date of Patent:** **** Jul. 21, 2015**

(54) **TOOL RACK**

(71) Applicant: **Chia-Chun Liu**, Taichung (TW)

(72) Inventor: **Chia-Chun Liu**, Taichung (TW)

(**) Term: **14 Years**

(21) Appl. No.: **29/471,748**

(22) Filed: **Nov. 4, 2013**

(51) **LOC (10) Cl.** **03-02**

(52) **U.S. Cl.**
USPC **D3/315**

(58) **Field of Classification Search**
USPC D3/204, 218, 226, 230, 232, 243, 245,
D3/246, 247, 249, 272, 273, 275, 276,
D3/283-285, 289, 290, 299, 303, 315,
D3/294-296, 903; 206/6.1, 235, 457, 349,
206/373, 5, 38, 380, 579, 581, 377;
220/833, 836, DIG. 13; 224/249

See application file for complete search history.

(56) **References Cited**

U.S. PATENT DOCUMENTS

3,370,696	A *	2/1968	Groe	294/161
D284,810	S *	7/1986	Kelemen, Sr.	D3/315
D433,613	S *	11/2000	Jialin	D8/71
6,202,864	B1 *	3/2001	Ernst et al.	211/70.6
D440,852	S *	4/2001	Ernst	D8/71

6,679,391	B1 *	1/2004	Huang	211/70.6
7,178,670	B2 *	2/2007	Chen	206/376
D548,464	S *	8/2007	Lin	D3/315
D566,508	S *	4/2008	Lin	D8/71
7,537,124	B2 *	5/2009	Chen	211/70.6
8,261,911	B2 *	9/2012	Lee	206/376

* cited by examiner

Primary Examiner — Ian Simmons
Assistant Examiner — Charles Hanson

(57) **CLAIM**

I claim the ornamental design for a tool rack, as shown and described.

DESCRIPTION

FIG. 1 is a perspective view of a tool rack, showing my new design;
FIG. 2 is a front view of the tool rack shown in FIG. 1;
FIG. 3 is a rear view of the tool rack shown in FIG. 1, wherein several cavities are shown in broken lines for illustrative purposes only and do not form part of the claimed design;
FIG. 4 is a left side view of the tool rack shown in FIG. 1;
FIG. 5 is a right side view of the tool rack shown in FIG. 1;
FIG. 6 is a top view of the tool rack shown in FIG. 1;
FIG. 7 is a bottom view of the tool rack shown in FIG. 1; and,
FIG. 8 is another perspective view of the tool rack of FIG. 1, wherein wrenches are shown in broken lines for illustrative purposes only and do not form part of the claimed design.

1 Claim, 8 Drawing Sheets

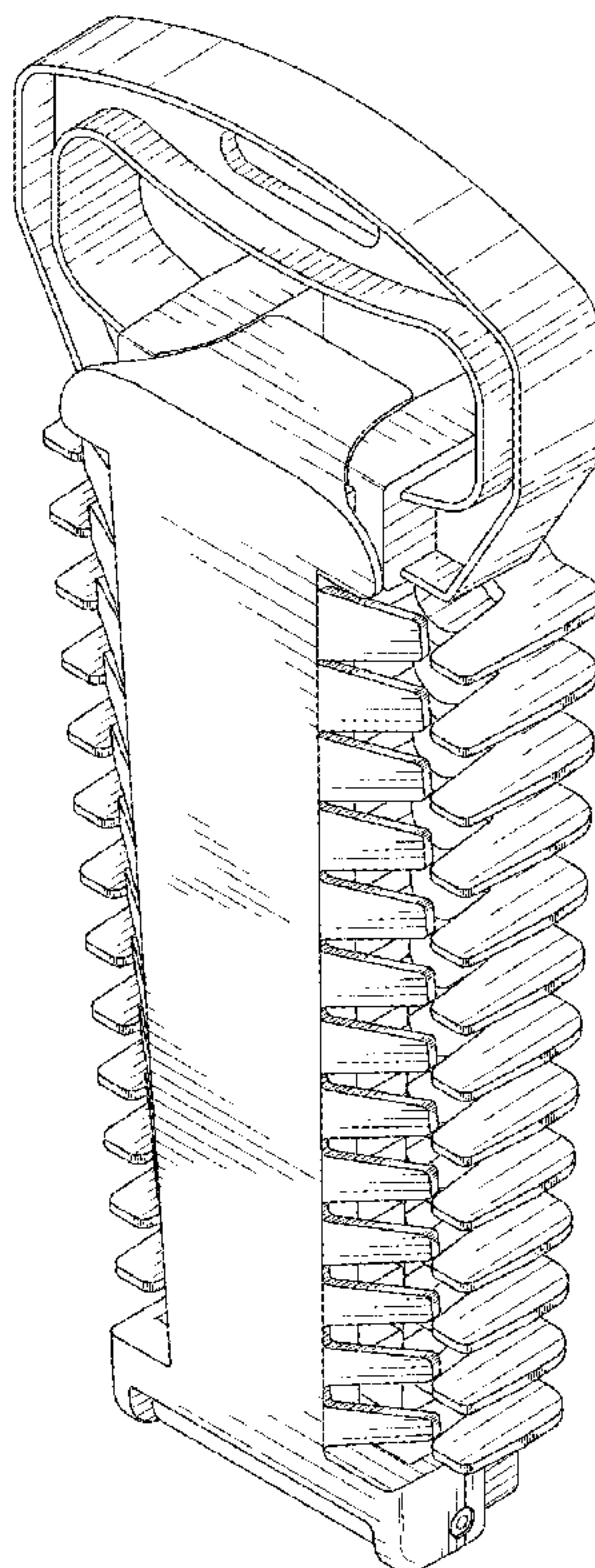

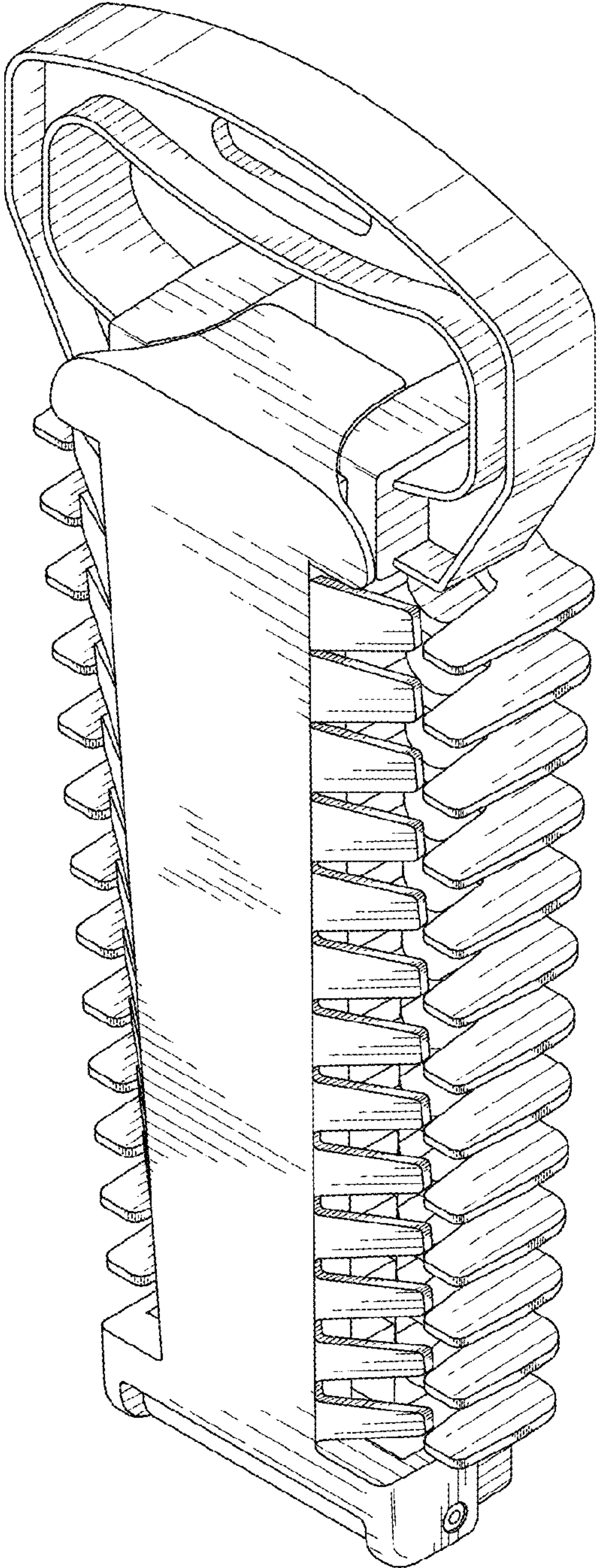

FIG.1

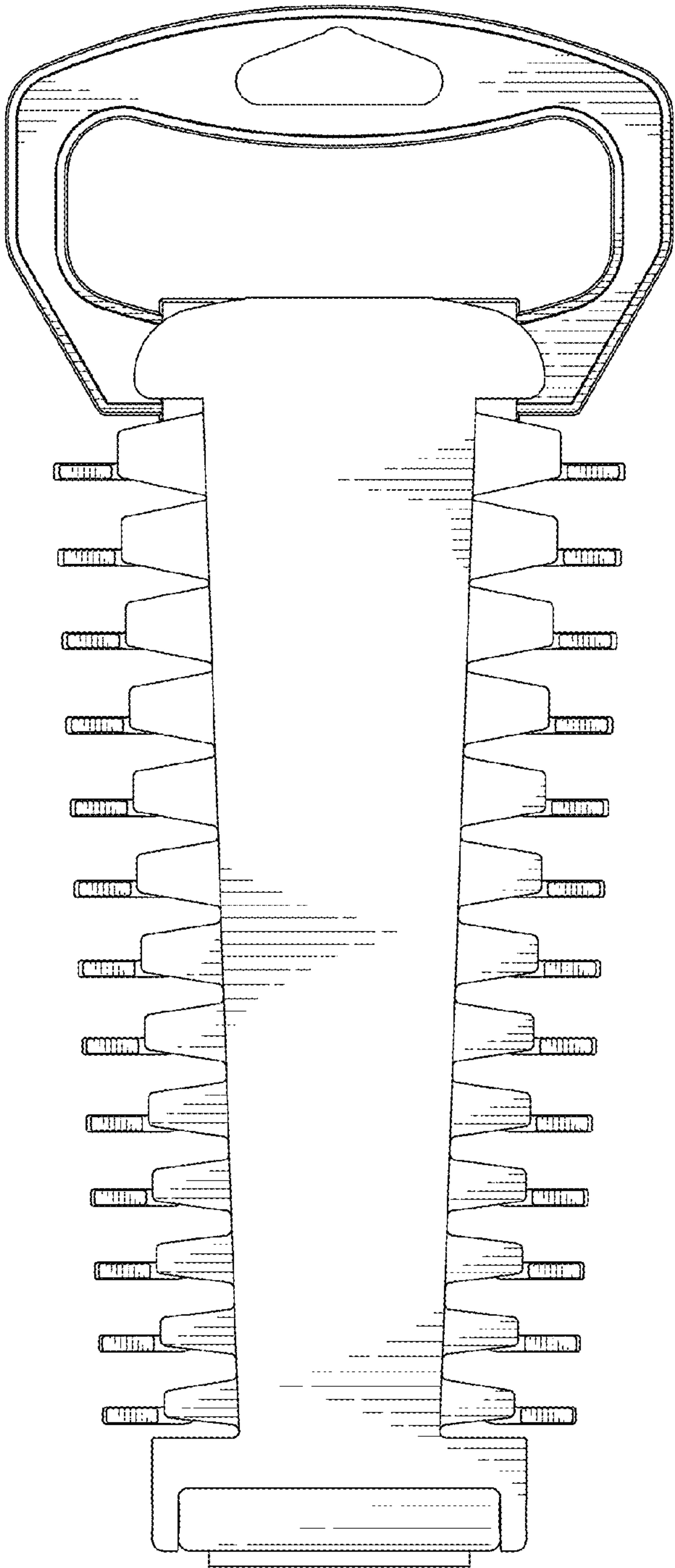

FIG.2

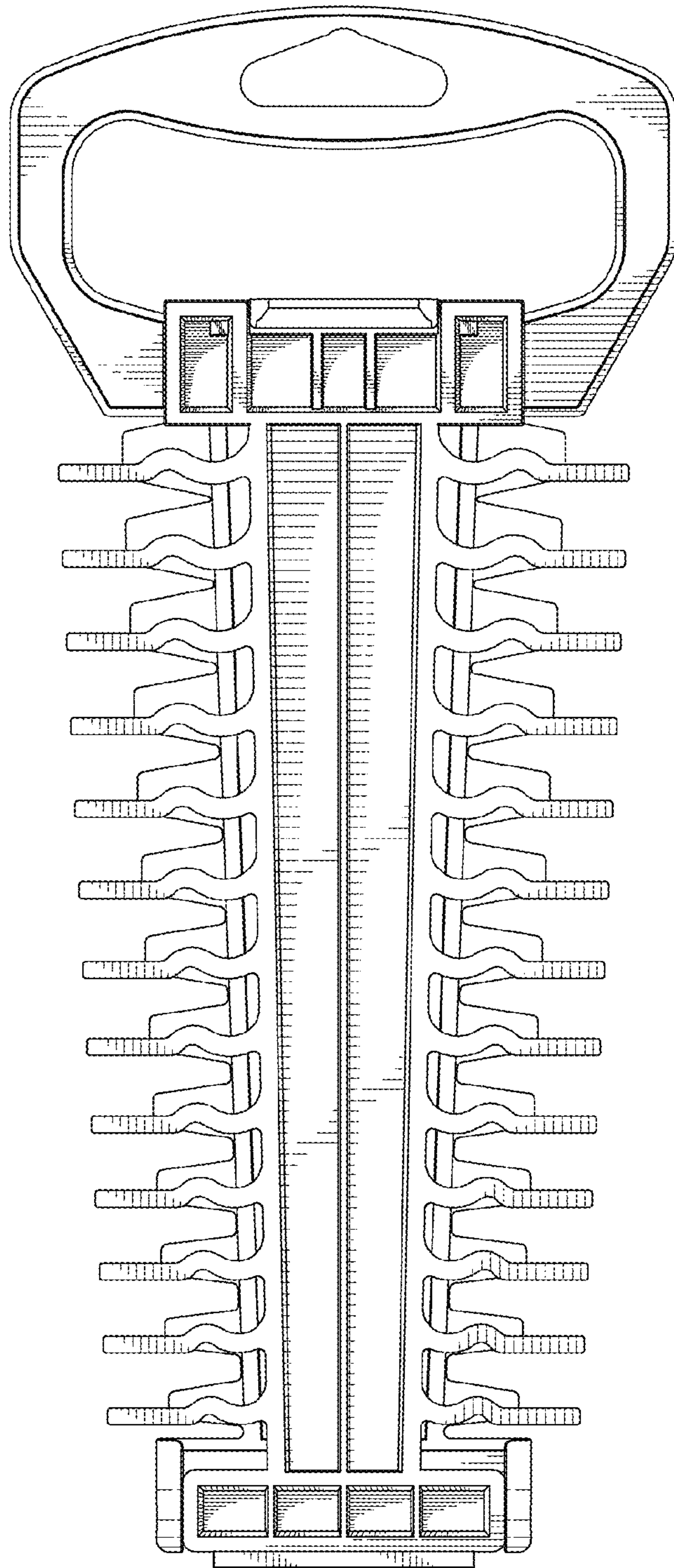

FIG.3

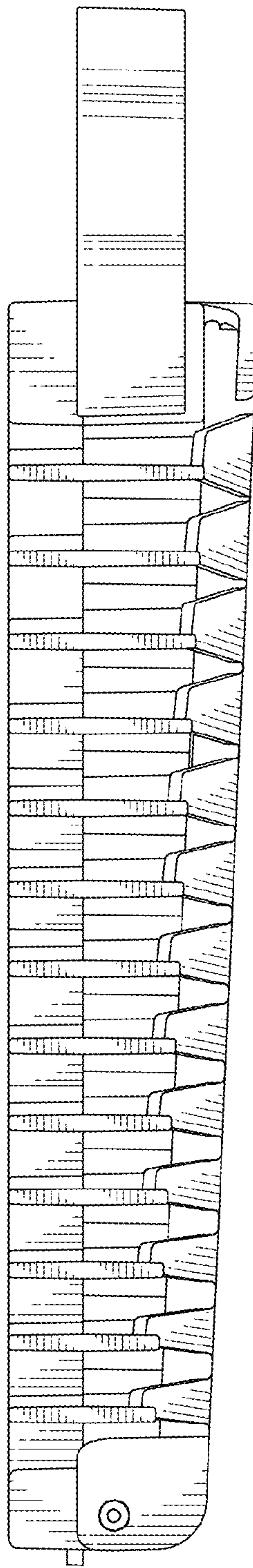

FIG.4

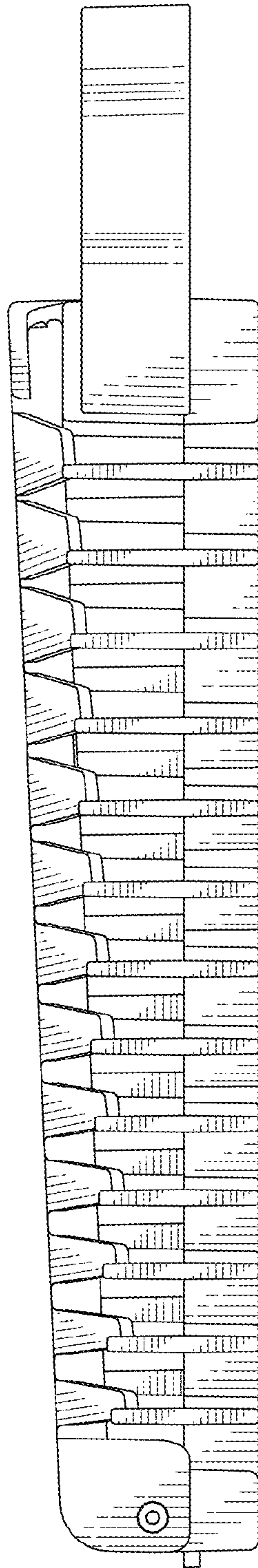

FIG.5

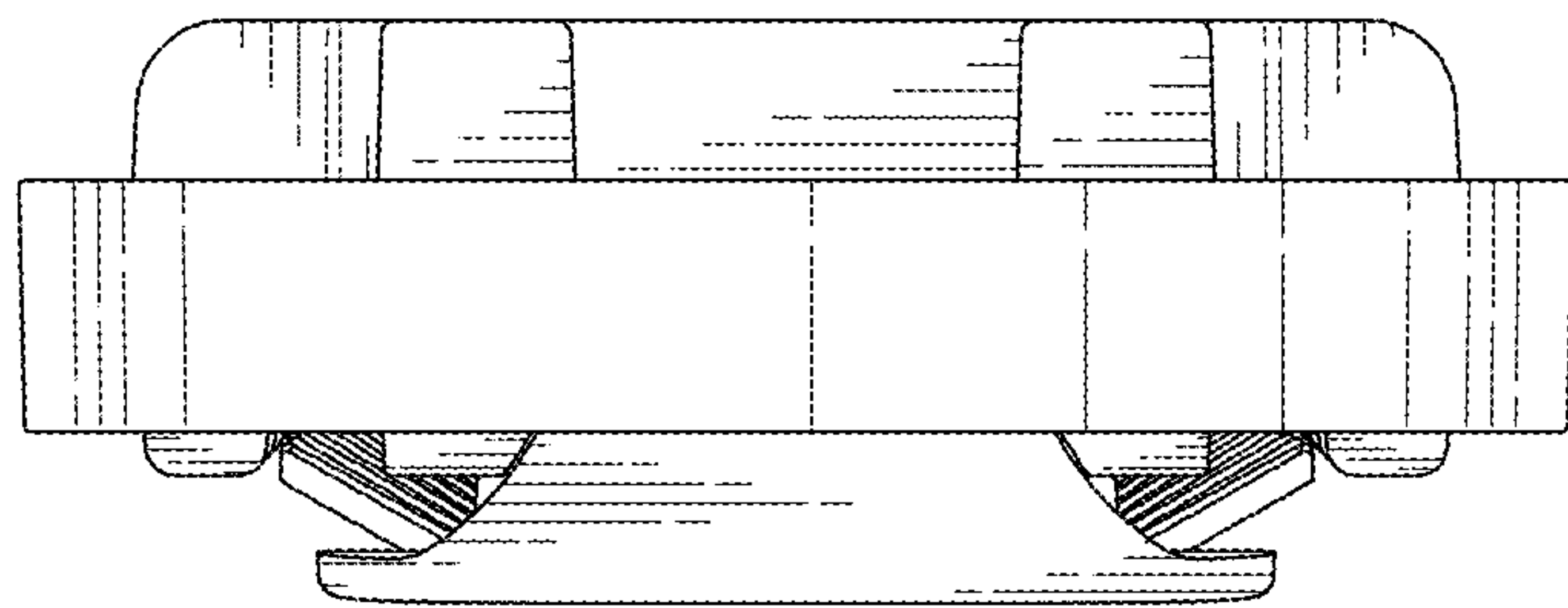

FIG.6

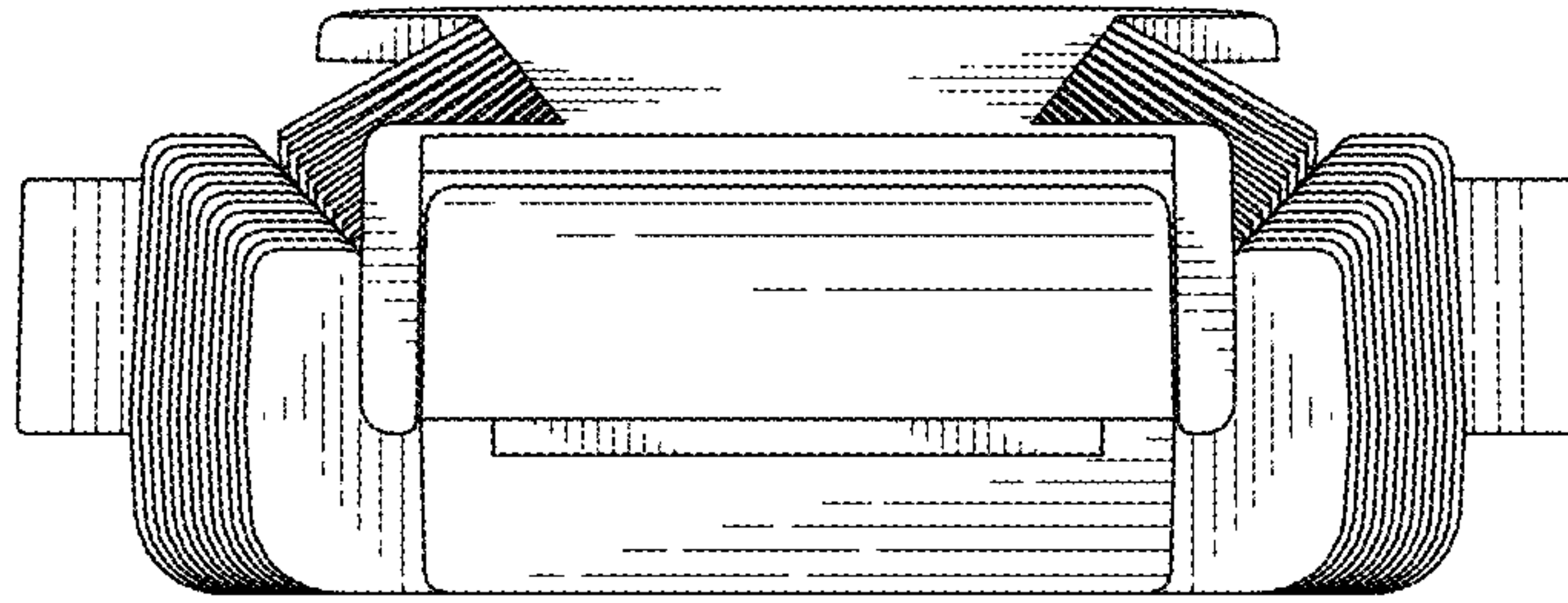

FIG.7

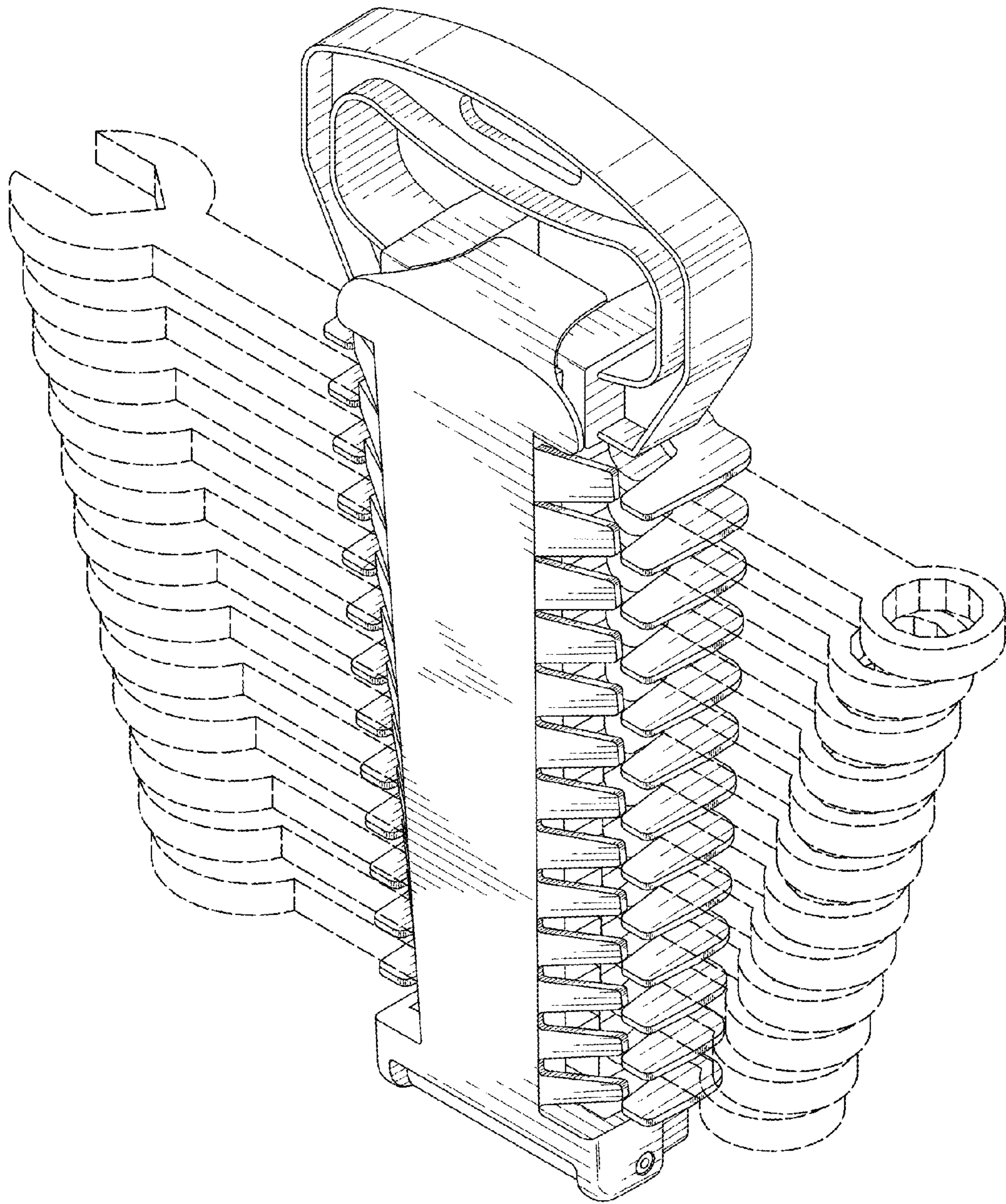

FIG. 8