



US00D734578S

(12) **United States Design Patent**  
**Colangelo**

(10) **Patent No.:** **US D734,578 S**

(45) **Date of Patent:** **\*\* Jul. 14, 2015**

(54) **INTERIOR SLEEVE FOR DUSTER OR  
CLEANING CLOTHS**

8,528,151 B2 \* 9/2013 Przepasniak ..... 15/229.3  
D709,659 S \* 7/2014 Colangelo ..... D32/40  
D716,008 S \* 10/2014 Colangelo ..... D32/40

(71) Applicant: **Joseph M Colangelo**, Boca Raton, FL  
(US)

\* cited by examiner

(72) Inventor: **Joseph M Colangelo**, Boca Raton, FL  
(US)

*Primary Examiner* — Robin V Webster

(74) *Attorney, Agent, or Firm* — Smith Risley Tempel  
Santos LLC; Gregory Scott Smith

(\*\*) Term: **14 Years**

(57) **CLAIM**

The ornamental design for a interior sleeve for duster or  
cleaning cloths, as shown and described.

(21) Appl. No.: **29/491,811**

**DESCRIPTION**

(22) Filed: **May 23, 2014**

**Related U.S. Application Data**

(63) Continuation of application No. 29/458,469, filed on  
Jun. 20, 2013, now Pat. No. Des. 709,659.

(51) **LOC (10) Cl.** ..... **23-01**

(52) **U.S. Cl.**  
USPC ..... **D32/40**

(58) **Field of Classification Search**  
USPC ..... D32/40-46; 15/244.1-244.4, 209.1,  
15/118, 211, 228, 229.4, 229.6, 229.8,  
15/229.3, 210.1

See application file for complete search history.

FIG. 1 is a perspective view of the interior sleeve for duster or  
cleaning cloths;

FIG. 2 is an exploded perspective view of the interior sleeve  
for duster or cleaning cloths illustrated in FIG. 1;

FIG. 3 is a top plan view of the interior sleeve for duster or  
cleaning cloths illustrated in FIG. 1 with the bottom plan view  
being a mirror image of the top plan view;

FIG. 4 is a first side view of the interior sleeve for duster or  
cleaning cloths illustrated in FIG. 1, with the second side view  
being a mirror image of the first side view;

FIG. 5 is a front end elevation view of the interior sleeve for  
duster or cleaning cloths illustrated in FIG. 1; and,

FIG. 6 is a back end elevation view of the interior sleeve for  
duster or cleaning cloths illustrated in FIG. 1.

The interior sleeve for duster or cleaning cloths includes two  
internal sheets forming a pocket with an opening on the front  
end for receiving a portion of a handle. The pocket is sand-  
wiched between two duster elements. The broken lines illus-  
trated in the figures form no part of the claim but rather only  
are provided to illustrate the environment in which the inven-  
tion can exist.

(56) **References Cited**

**U.S. PATENT DOCUMENTS**

7,779,502 B2 \* 8/2010 Fujiwara et al. .... 15/229.4  
8,151,402 B2 \* 4/2012 Takabayashi et al. .... 15/229.3  
8,245,349 B2 \* 8/2012 Tsuchiya et al. .... 15/229.3

**1 Claim, 5 Drawing Sheets**

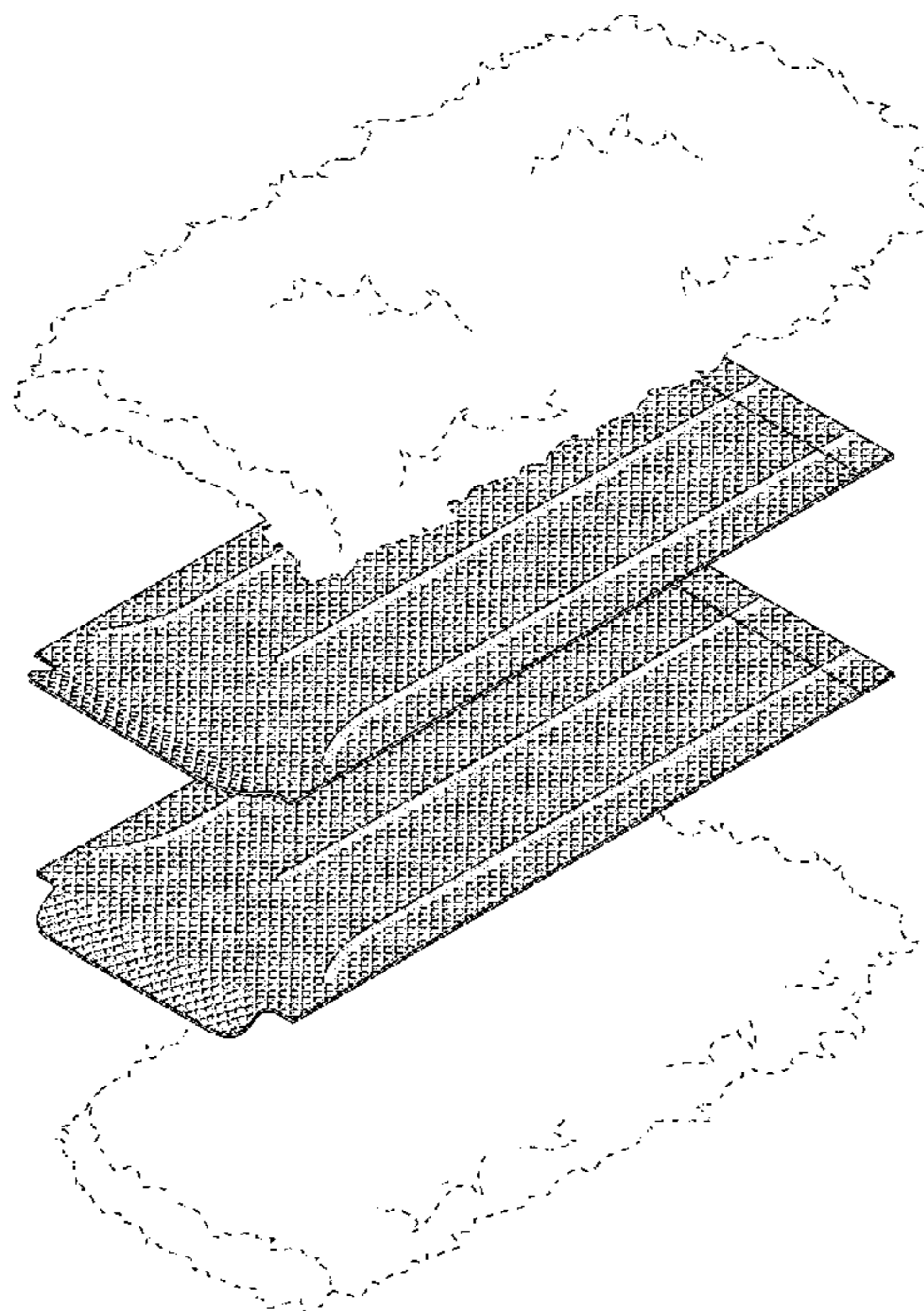

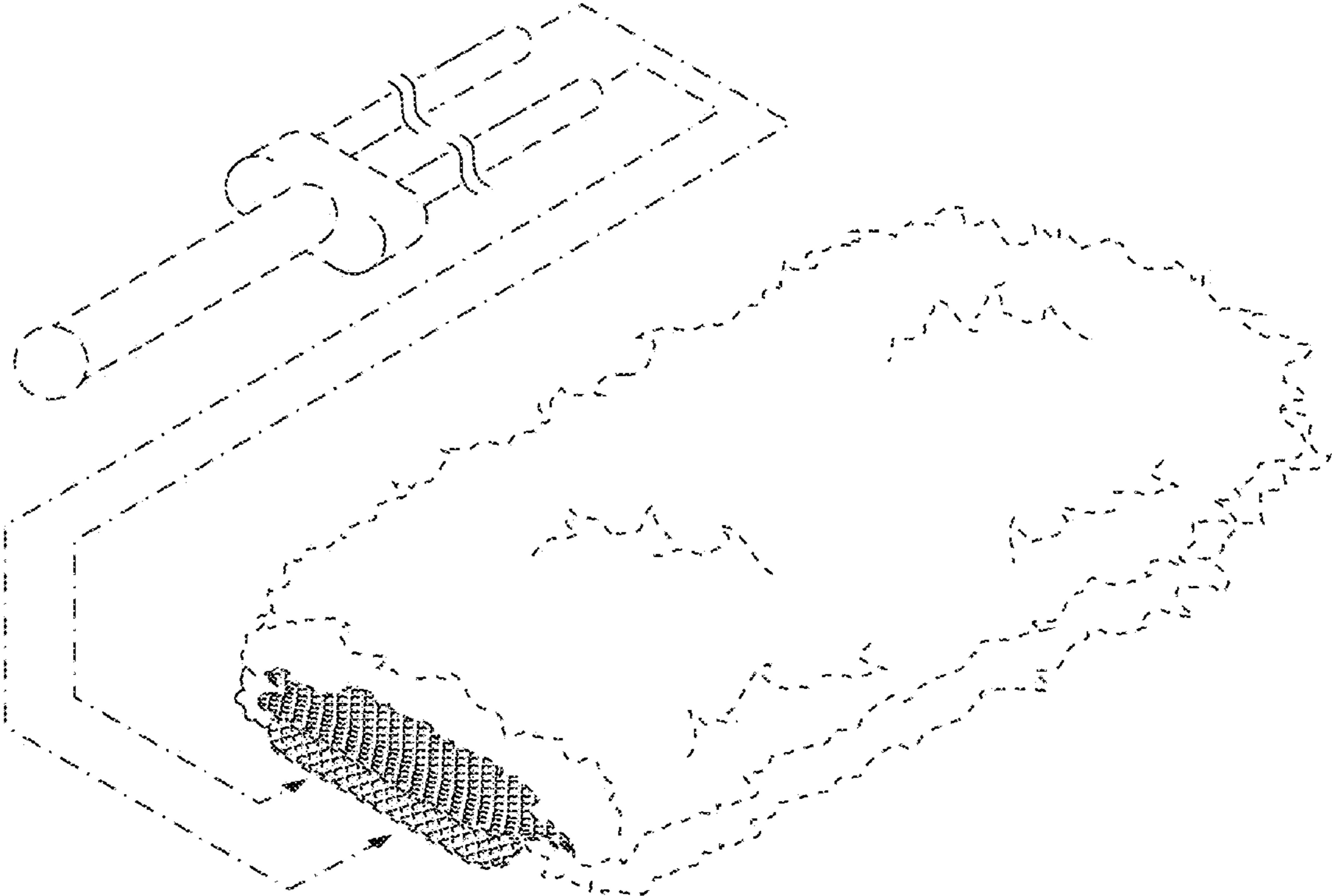

Fig. 1



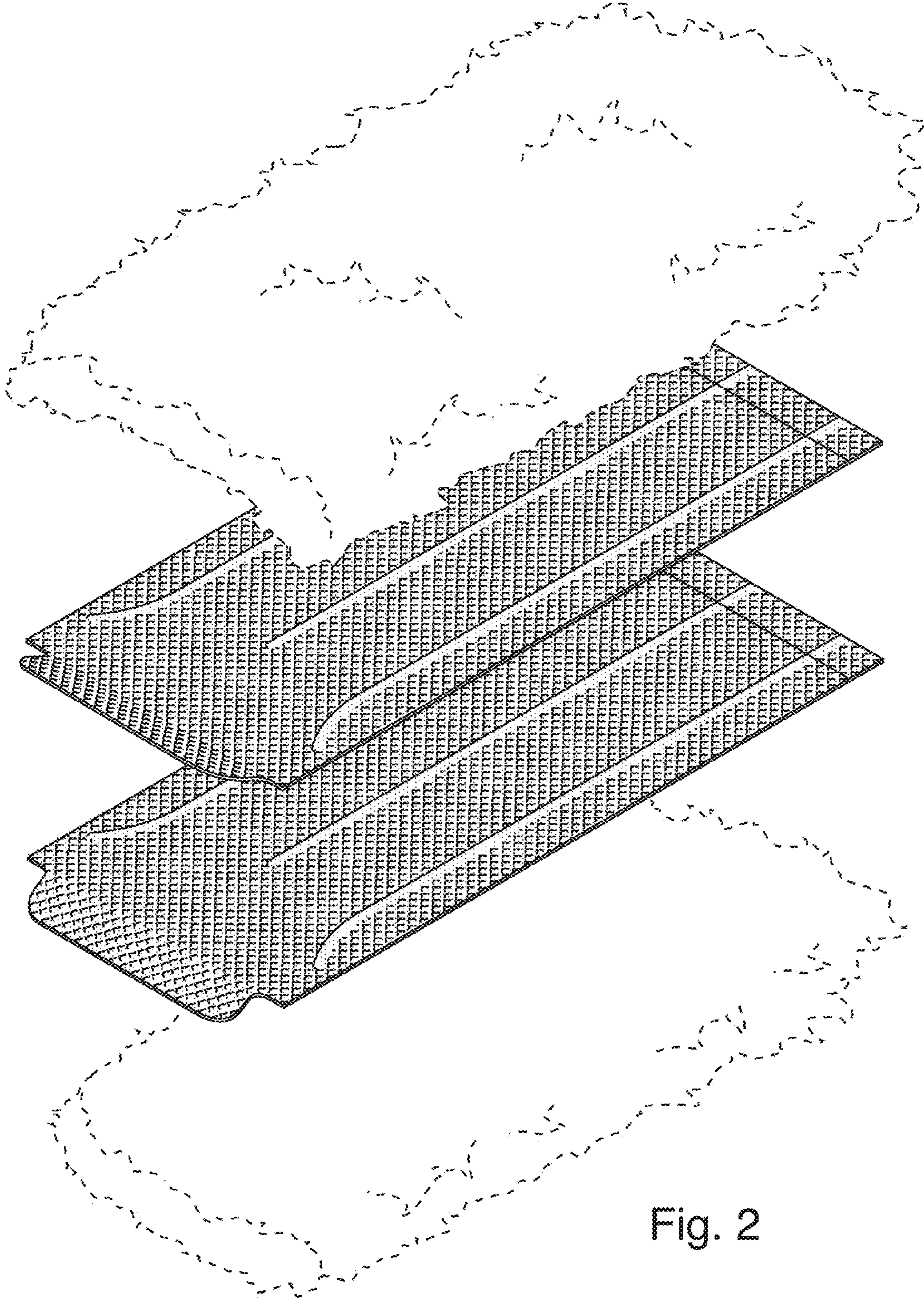

Fig. 2

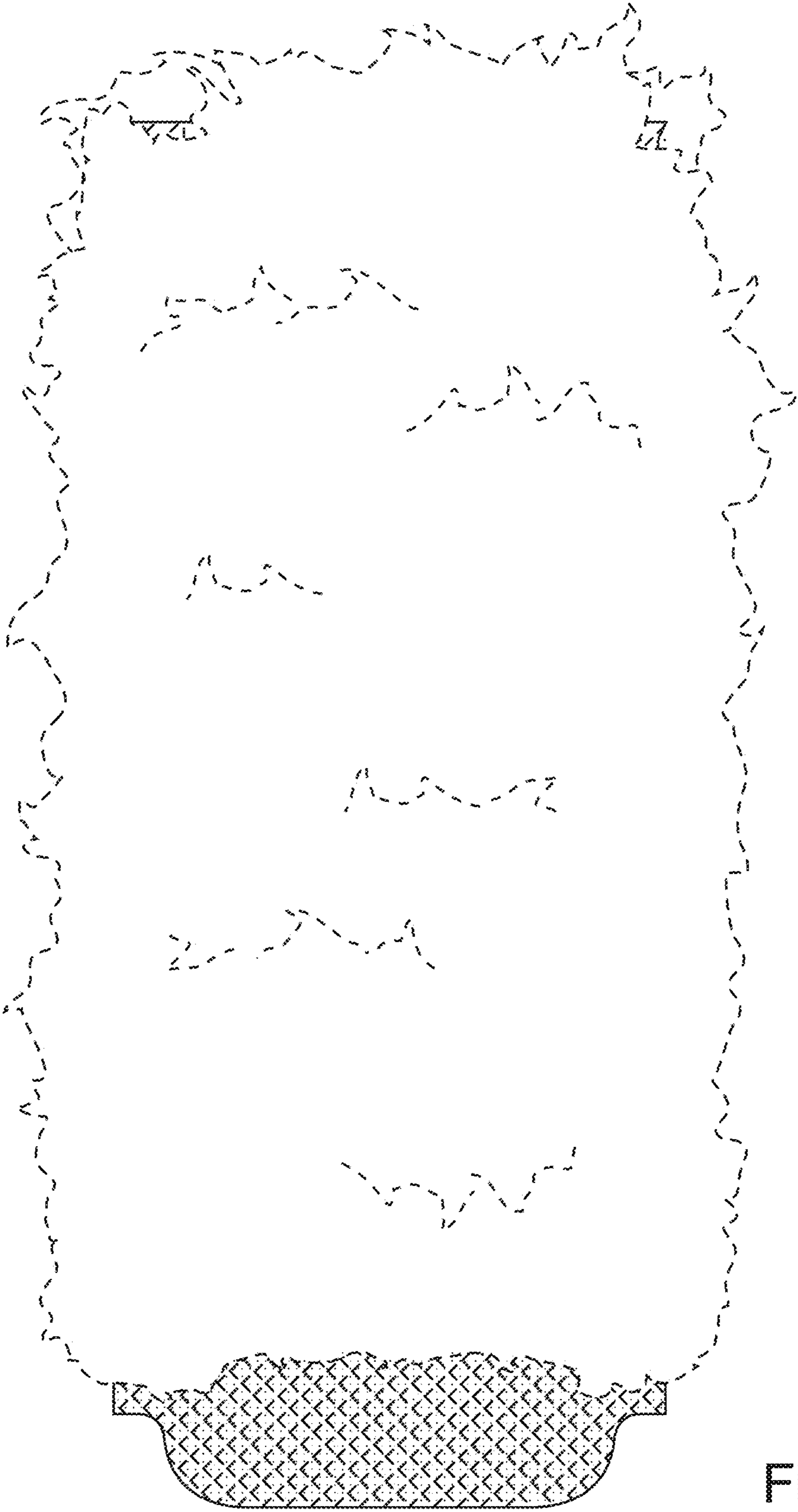

Fig. 3

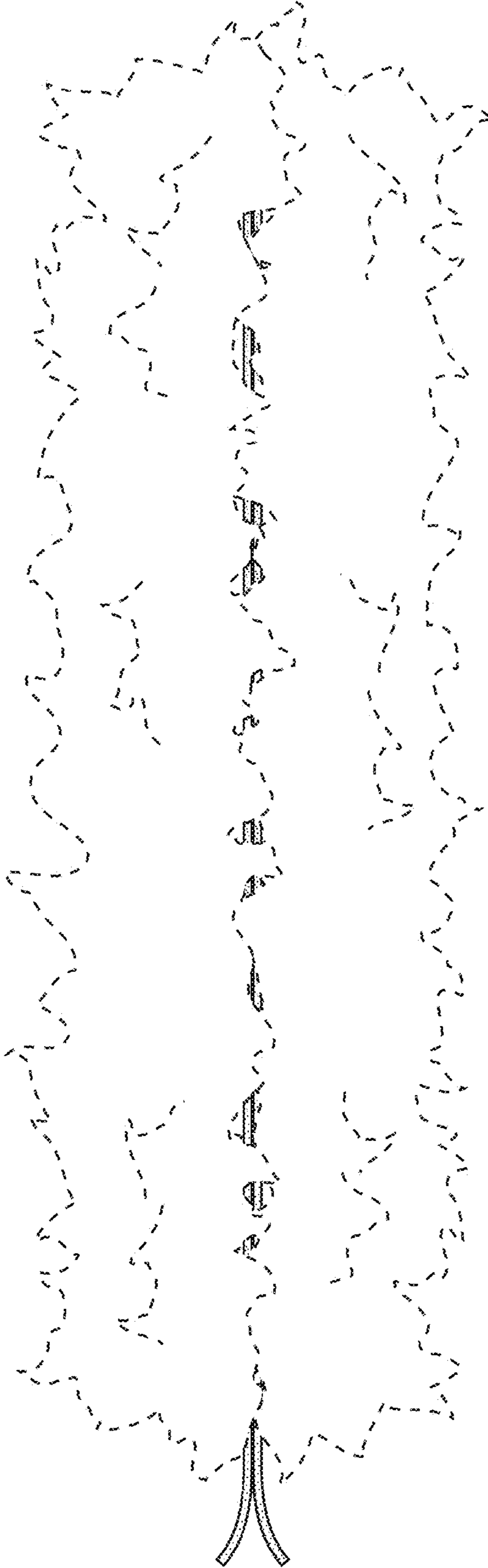

Fig. 4

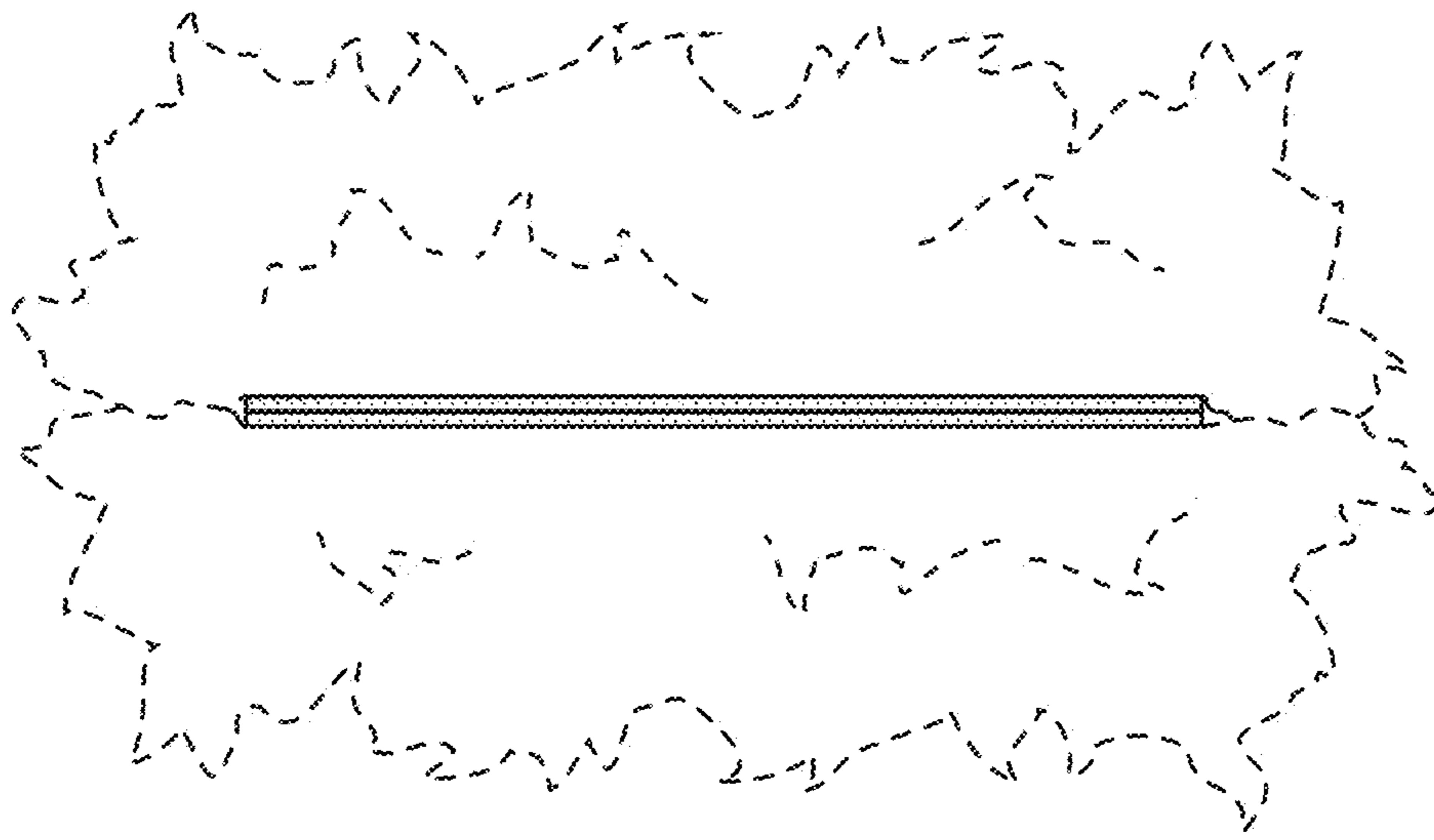

Fig. 5

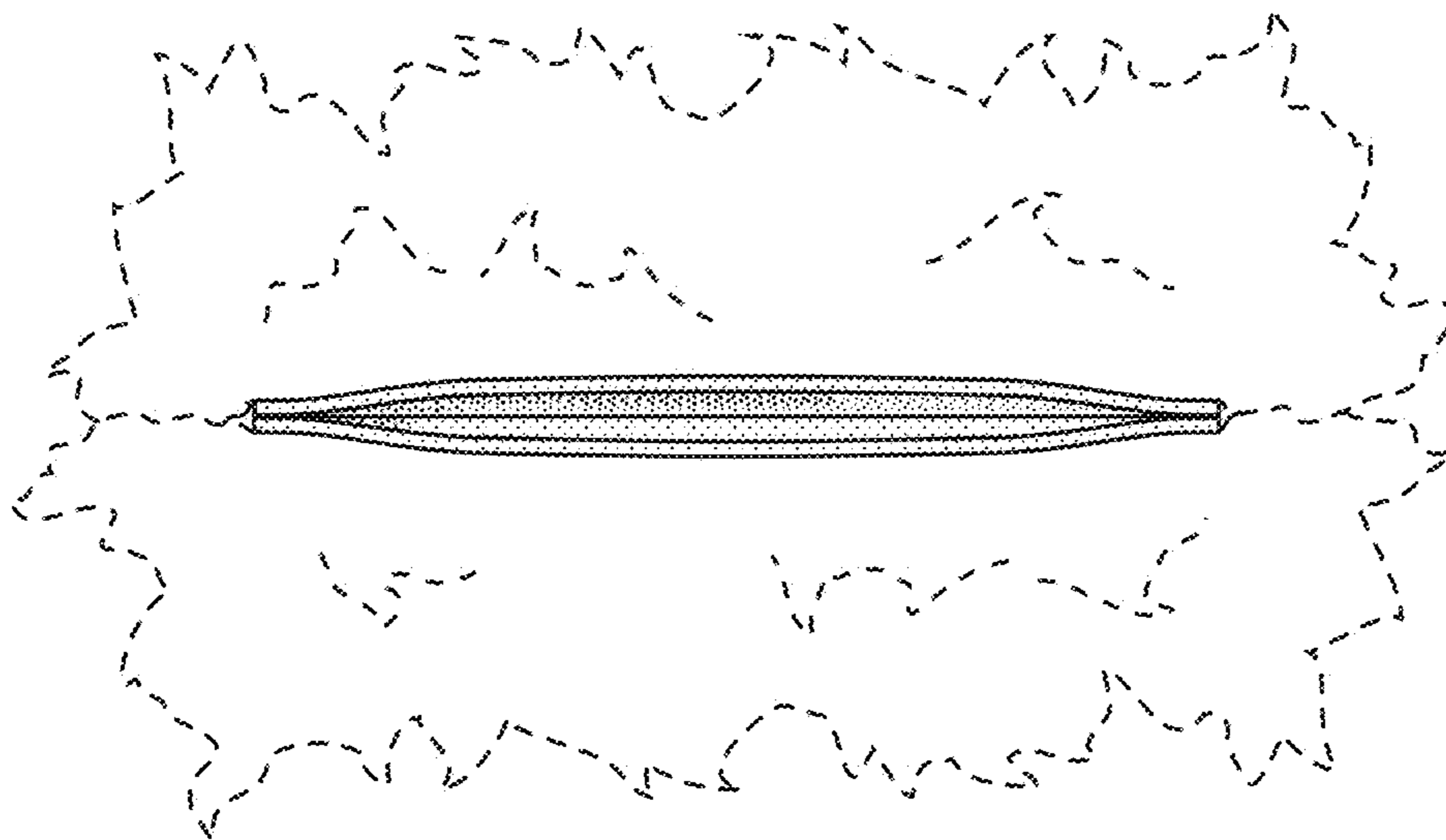

Fig. 6