



US00D734575S

(12) **United States Design Patent**
Zeng

(10) **Patent No.:** **US D734,575 S**
(45) **Date of Patent:** **** Jul. 14, 2015**

(54) **SURFACE CLEANING DEVICE**

(71) Applicant: **Guang'an Zeng**, Shenzhen (CN)

(72) Inventor: **Guang'an Zeng**, Shenzhen (CN)

(**) Term: **14 Years**

(21) Appl. No.: **29/490,461**

(22) Filed: **May 9, 2014**

(51) **LOC (10) Cl.** **15-05**

(52) **U.S. Cl.**
USPC **D32/18**

(58) **Field of Classification Search**

USPC D32/17, 18, 31, 21, 23-24; 15/344,
15/329, 347, 327.1, 327.2, 327.7,
15/352-353; 55/337, 429, 345, DIG. 3;
38/77.5, 77.9; 392/384, 404; 68/5 R,
68/5 A, 222; 223/51, 70, 73
See application file for complete search history.

(56) **References Cited**

U.S. PATENT DOCUMENTS

6,536,379 B1 * 3/2003 Liu 122/379
D485,651 S * 1/2004 Lin D32/17

D620,208 S * 7/2010 Mangano D32/17
D656,693 S * 3/2012 Lavy D32/17
D674,564 S * 1/2013 Mangano D32/17
2009/0183334 A1 * 7/2009 Carrubba 15/322

* cited by examiner

Primary Examiner — Ruth McInroy

(74) *Attorney, Agent, or Firm* — Alston & Bird LLP

(57) **CLAIM**

I claim the ornamental design for a surface cleaning device, as shown and described.

DESCRIPTION

FIG. 1 is a perspective view of a surface cleaning device showing the new design;
FIG. 2 is another perspective view thereof;
FIG. 3 is a front elevation view thereof;
FIG. 4 is a rear elevation view thereof;
FIG. 5 is a top plan view thereof;
FIG. 6 is a bottom plan view thereof.
FIG. 7 is a left side elevation view thereof; and,
FIG. 8 is a right side elevation view thereof.
The broken lines are directed to unclaimed features and form no part of the claimed design.

1 Claim, 7 Drawing Sheets

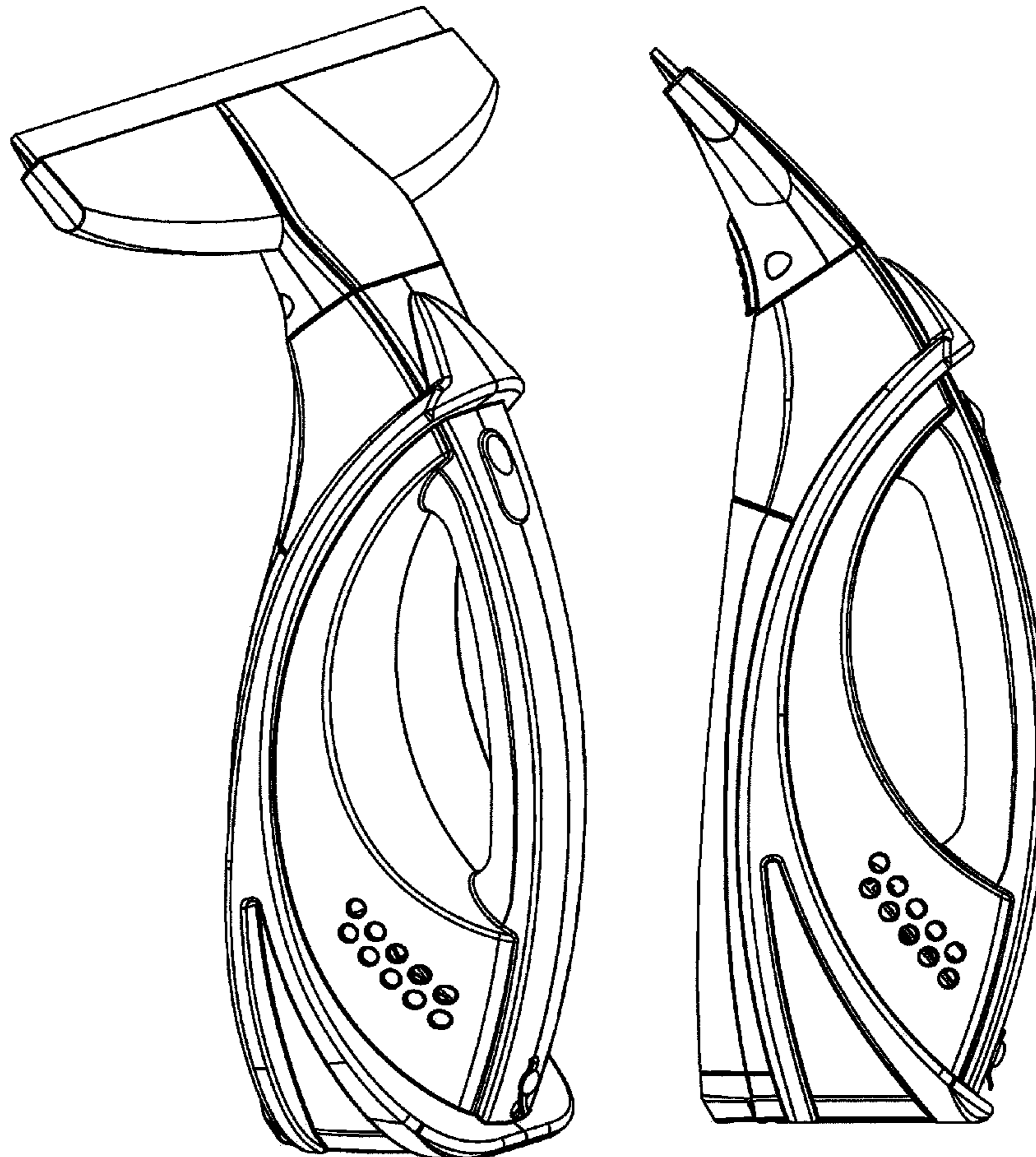

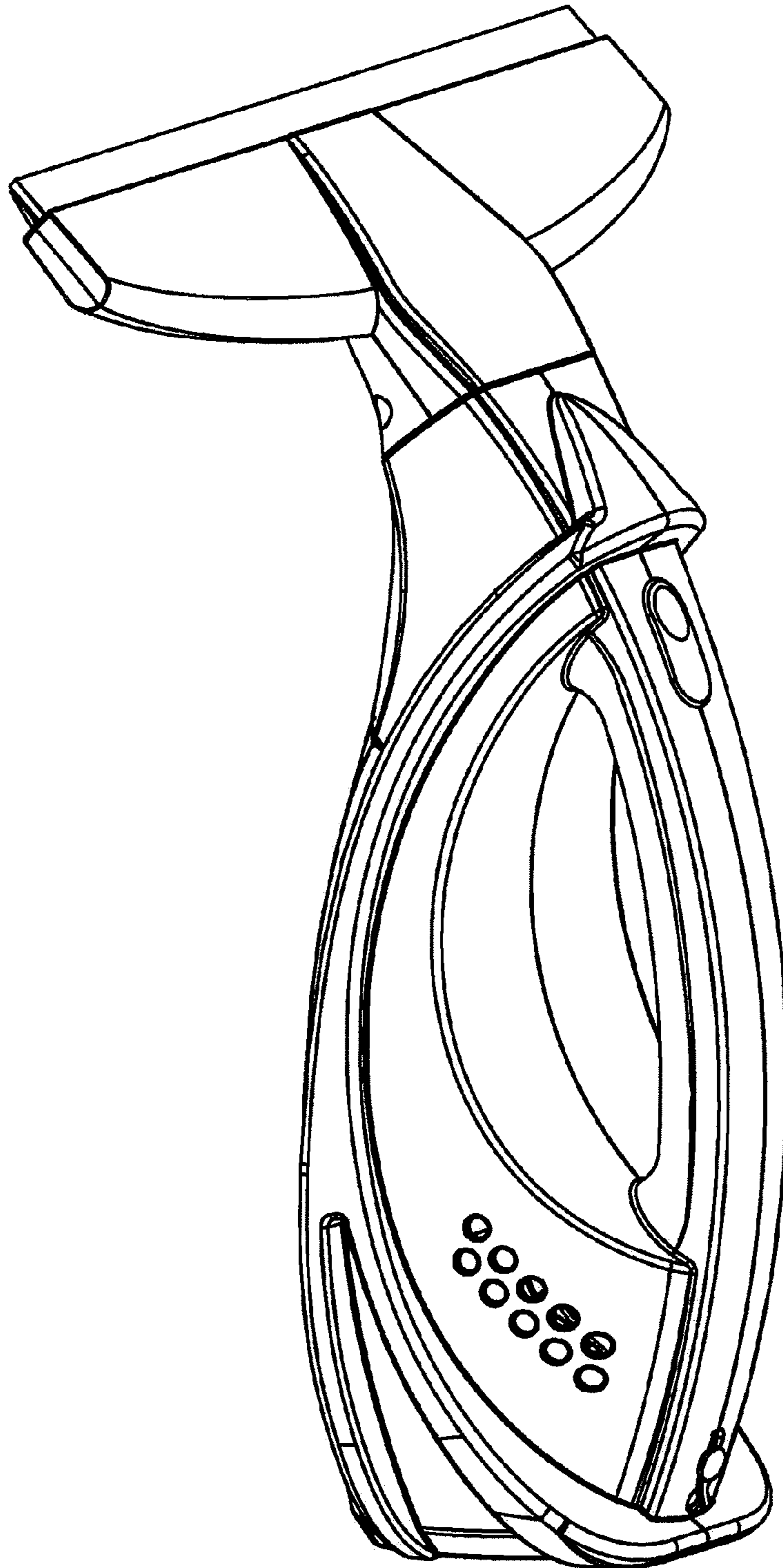

FIG. 1

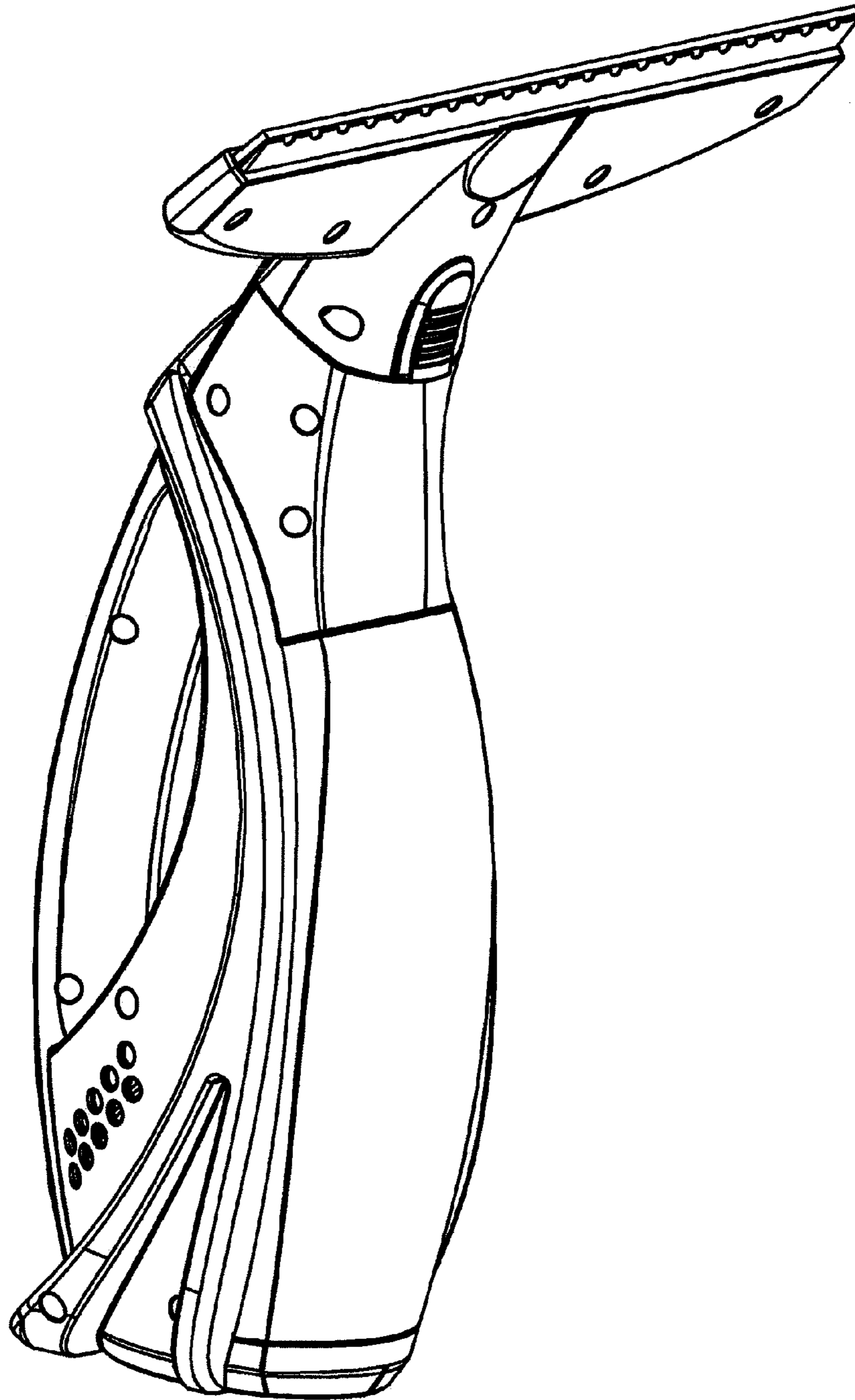

FIG. 2

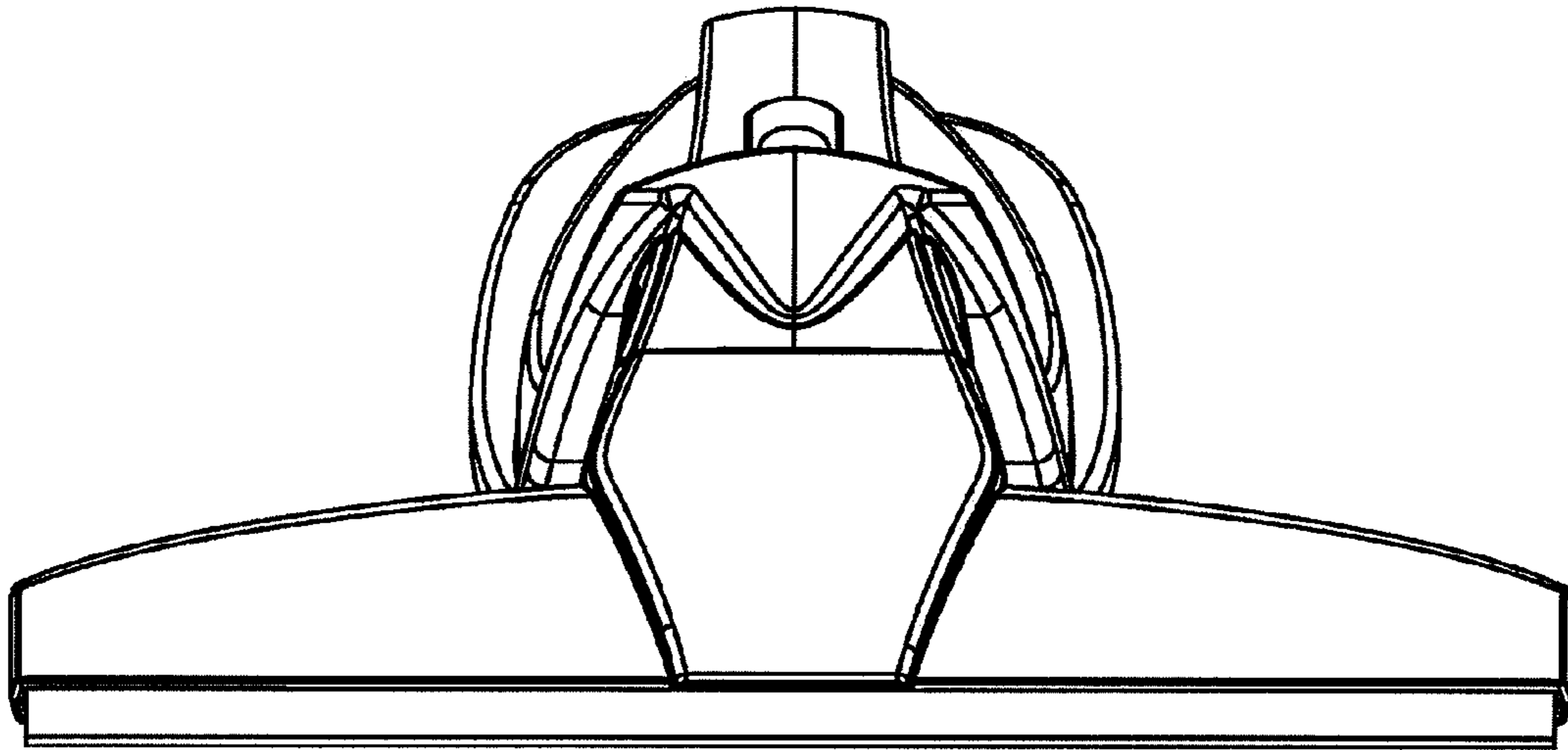

FIG. 3

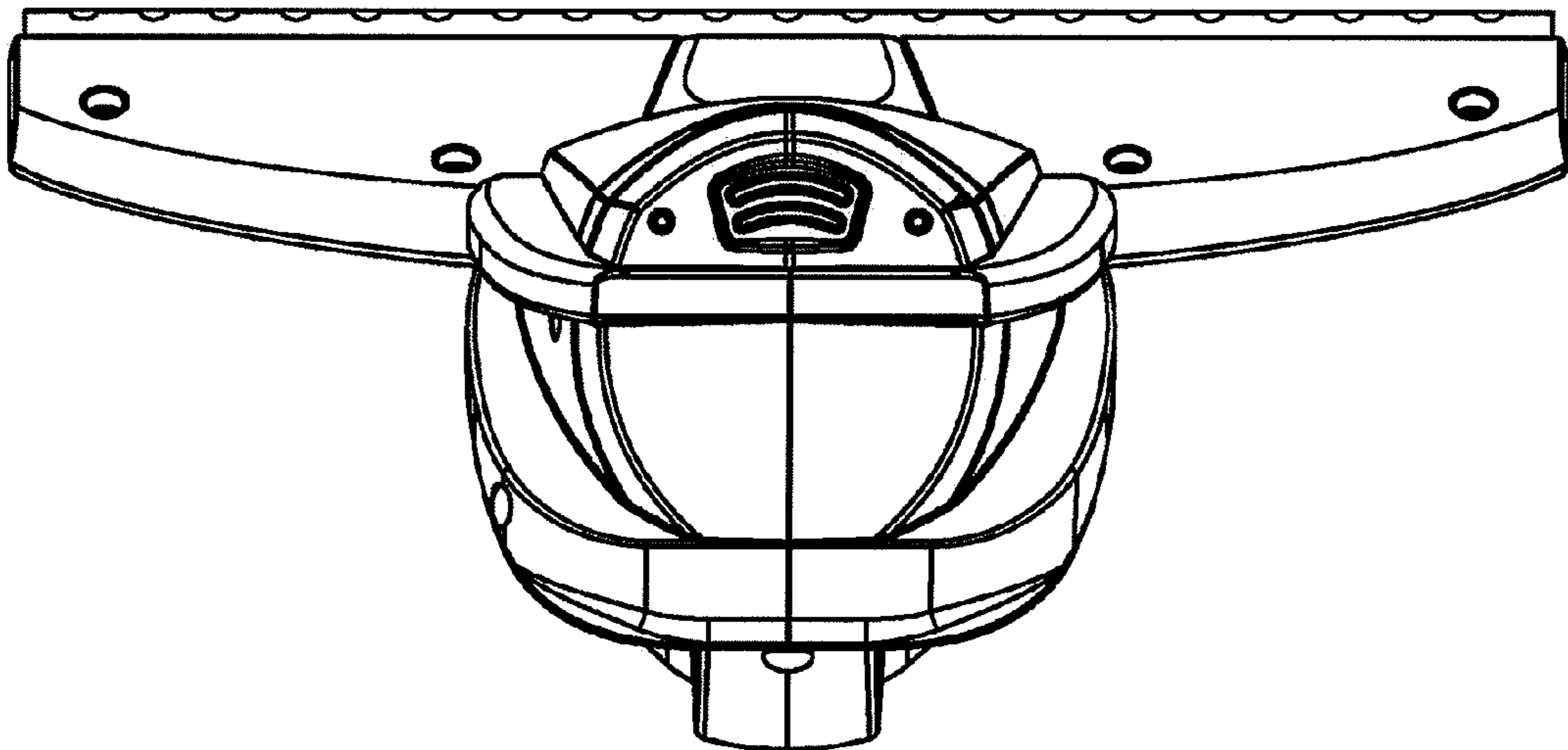

FIG. 4

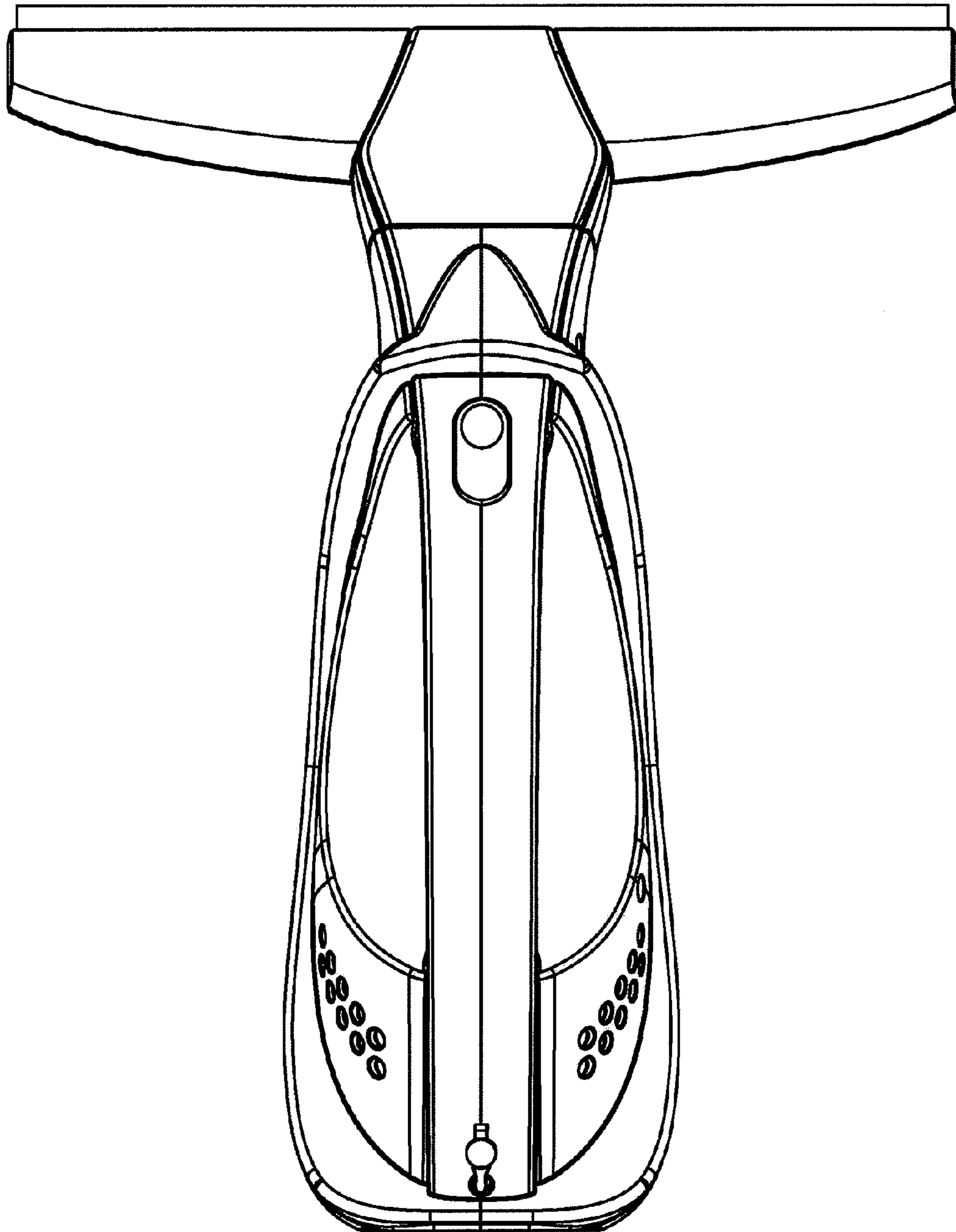

FIG. 5

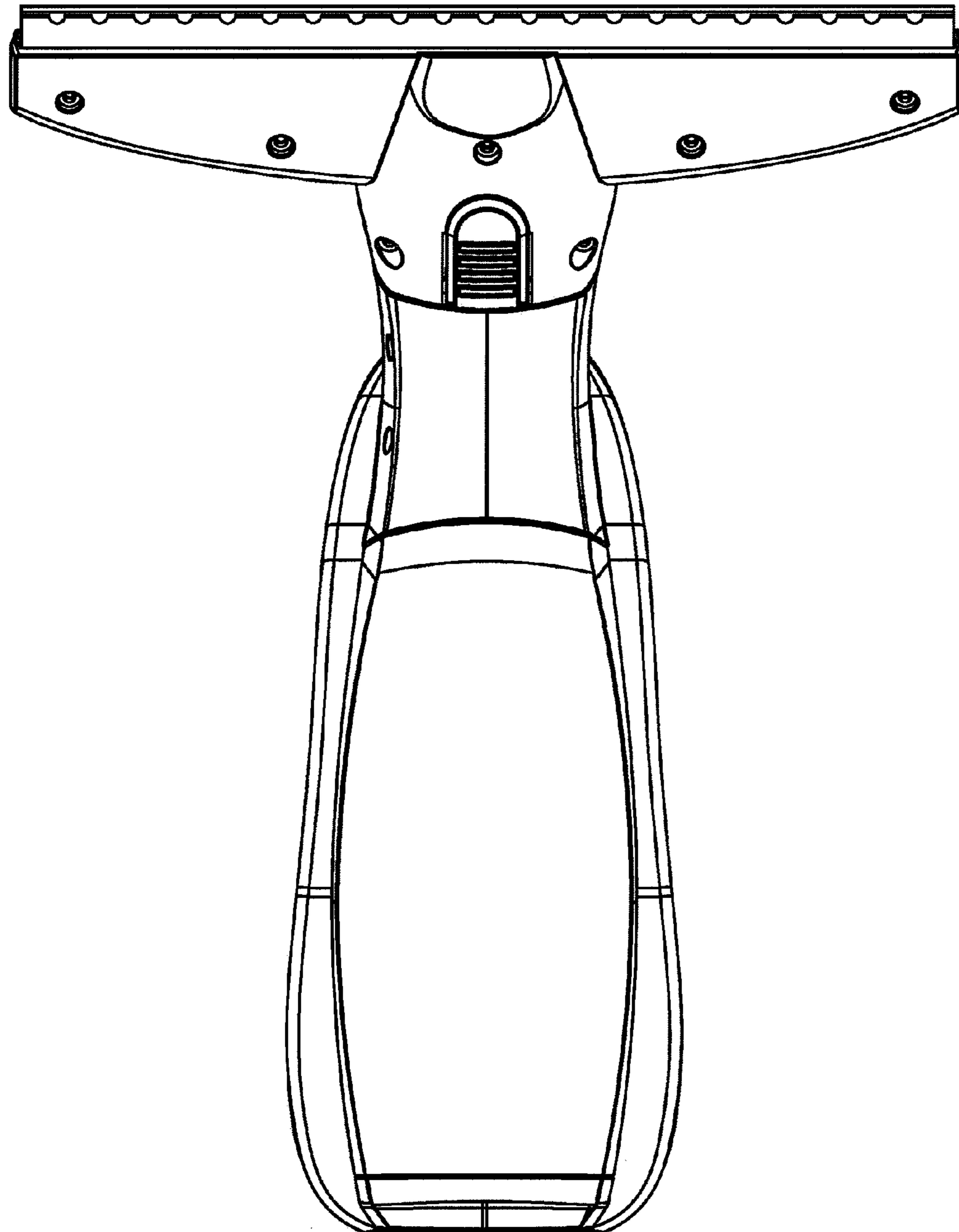

FIG. 6

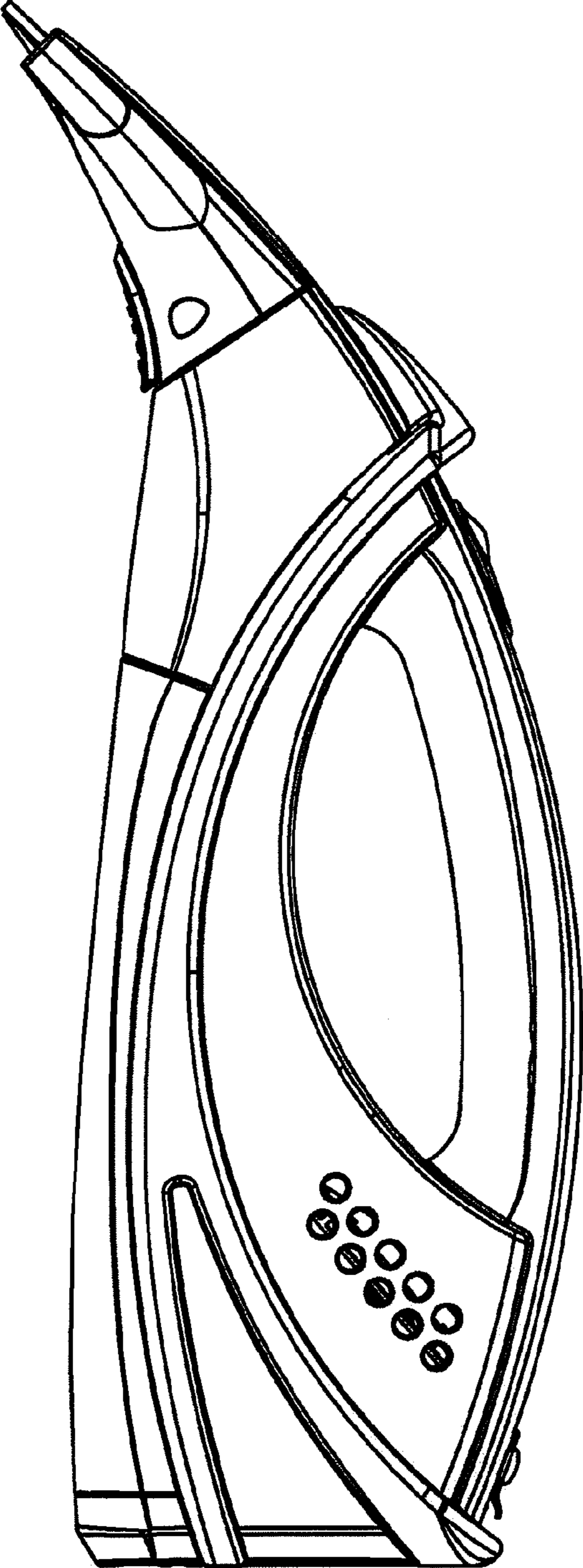

FIG. 7

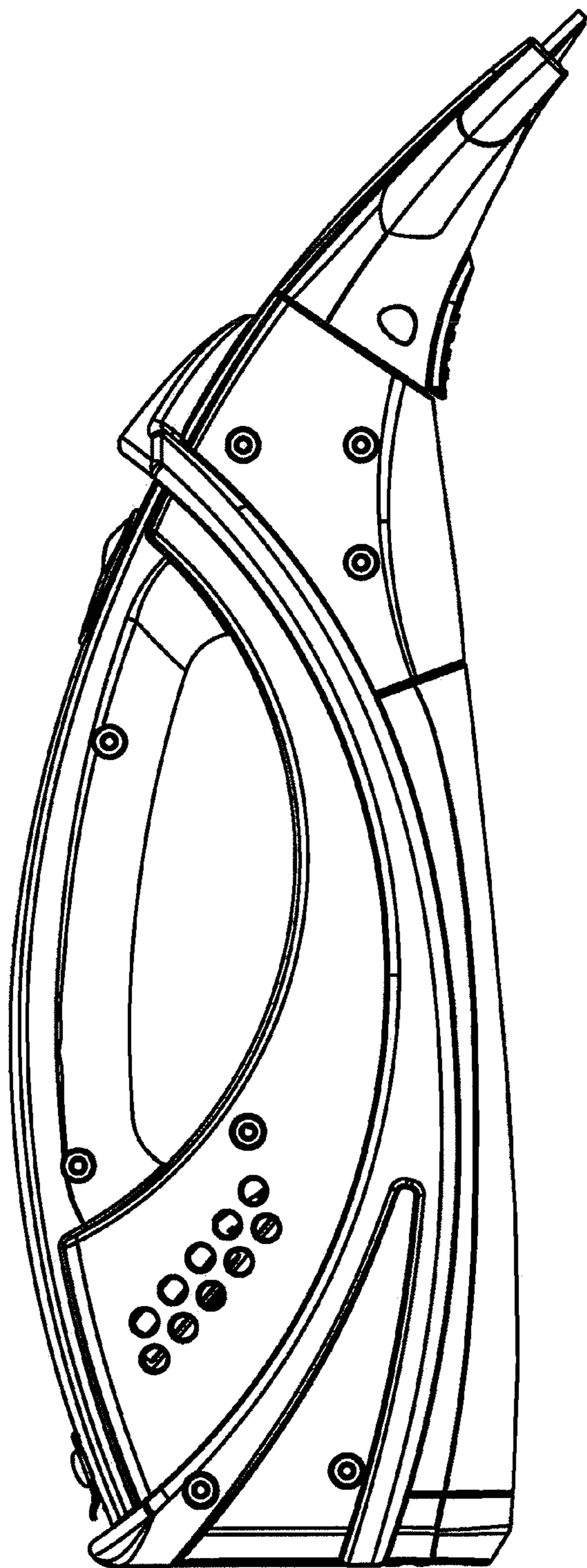

FIG. 8

UNITED STATES PATENT AND TRADEMARK OFFICE
CERTIFICATE OF CORRECTION

PATENT NO. : D734,575 S
APPLICATION NO. : 29/490461
DATED : July 14, 2015
INVENTOR(S) : Zeng

Page 1 of 9

It is certified that error appears in the above-identified patent and that said Letters Patent is hereby corrected as shown below:

Delete the title page and substitute therefore with the attached title page consisting of the corrected illustrative figure(s).

Delete Drawing Sheets 1-7 and substitute therefore the Drawing Sheets consisting of FIG. 1 - FIG. 8 as shown on the attached pages.

Signed and Sealed this
Eighth Day of March, 2016



Michelle K. Lee
Director of the United States Patent and Trademark Office

(12) **United States Design Patent**
Zeng

(10) **Patent No.:** **US D734,575 S**
(45) **Date of Patent:** **** Jul. 14, 2015**

(54) **SURFACE CLEANING DEVICE**

(71) Applicant: **Guang'an Zeng, Shenzhen (CN)**

(72) Inventor: **Guang'an Zeng, Shenzhen (CN)**

(**) Term: **14 Years**

(21) Appl. No.: **29/490,461**

(22) Filed: **May 9, 2014**

(51) **LOC (10) CL.** **15-05**

(52) **U.S. CL.**
USPC **D32/18**

(58) **Field of Classification Search**
USPC **D32/17, 18, 31, 21, 23, 24; 15/344,**
15/329, 347, 327.1, 327.2, 327.7,
15/352, 353; 55/337, 429, 345, DIG. 3;
38/77.5, 77.9; 392/384, 404; 68/5 R,
68/5 A, 222; 223/51, 70, 73
See application file for complete search history.

(56) **References Cited**

U.S. PATENT DOCUMENTS

6,536,379 B1 * 3/2003 Liu 122/379
D485,651 S * 1/2004 Lin D32/17

10620,208 S * 7/2010 Mangano D32/17
10656,693 S * 3/2012 Lavy D32/17
10674,564 S * 1/2013 Mangano D32/17
2009-0183334 A1 * 7/2009 Carrubba 15/322

* cited by examiner

Primary Examiner Ruth McInroy

(74) *Attorney, Agent, or Firm* Alston & Bird LLP

(57) **CLAIM**

I claim the ornamental design for a surface cleaning device, as shown and described.

DESCRIPTION

FIG. 1 is a perspective view of a surface cleaning device showing the new design;
FIG. 2 is another perspective view thereof;
FIG. 3 is a front elevation view thereof;
FIG. 4 is a rear elevation view thereof;
FIG. 5 is a top plan view thereof;
FIG. 6 is a bottom plan view thereof;
FIG. 7 is a left side elevation view thereof; and,
FIG. 8 is a right side elevation view thereof.
The broken lines are directed to unclaimed features and form no part of the claimed design.

1 Claim, 7 Drawing Sheets

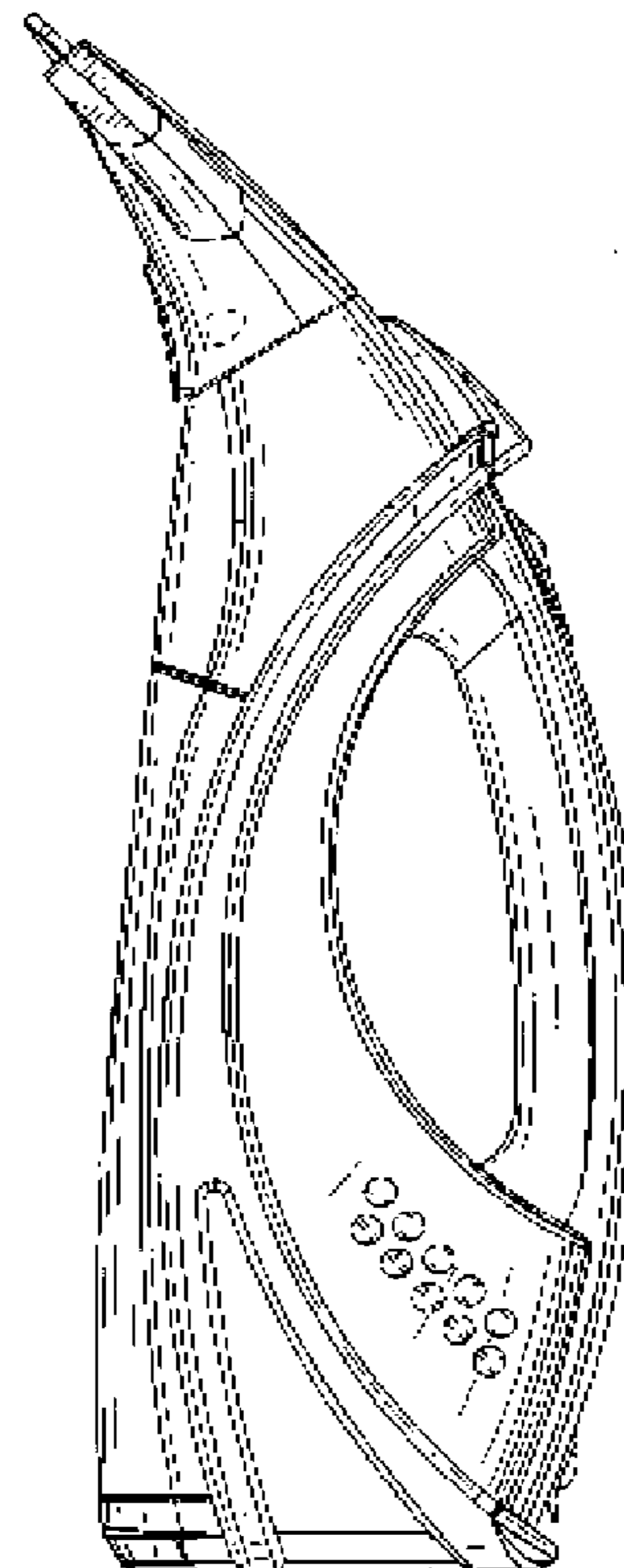
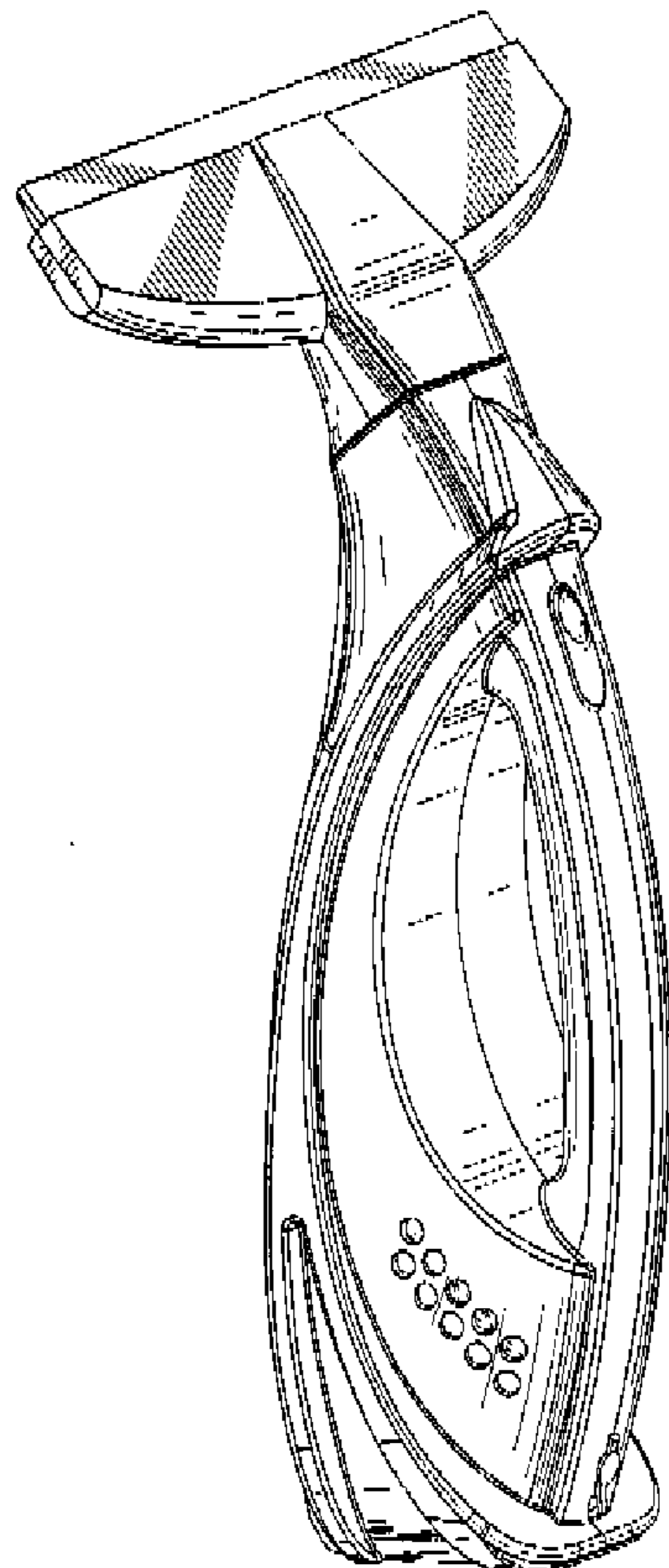

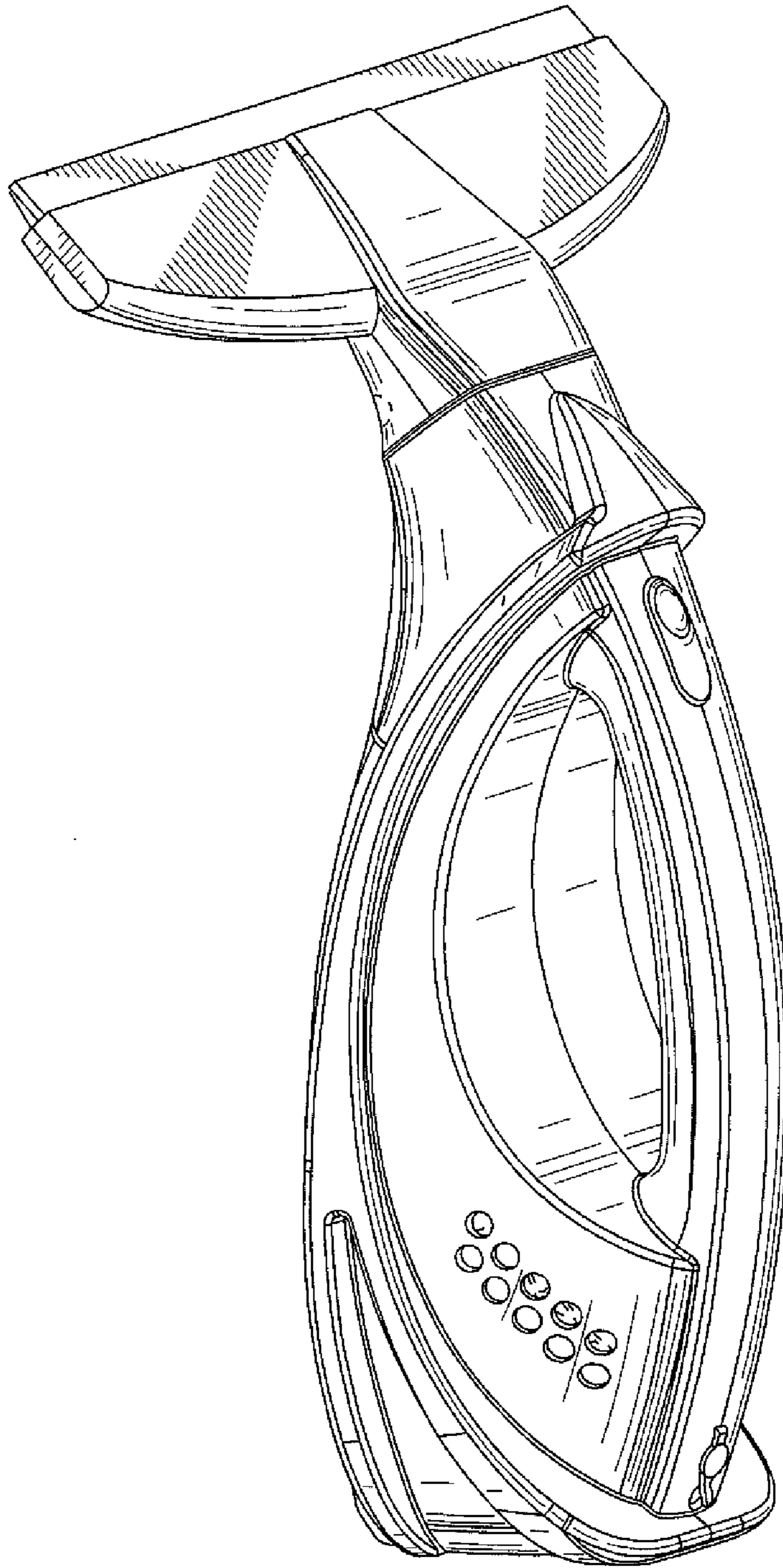

FIG. 1

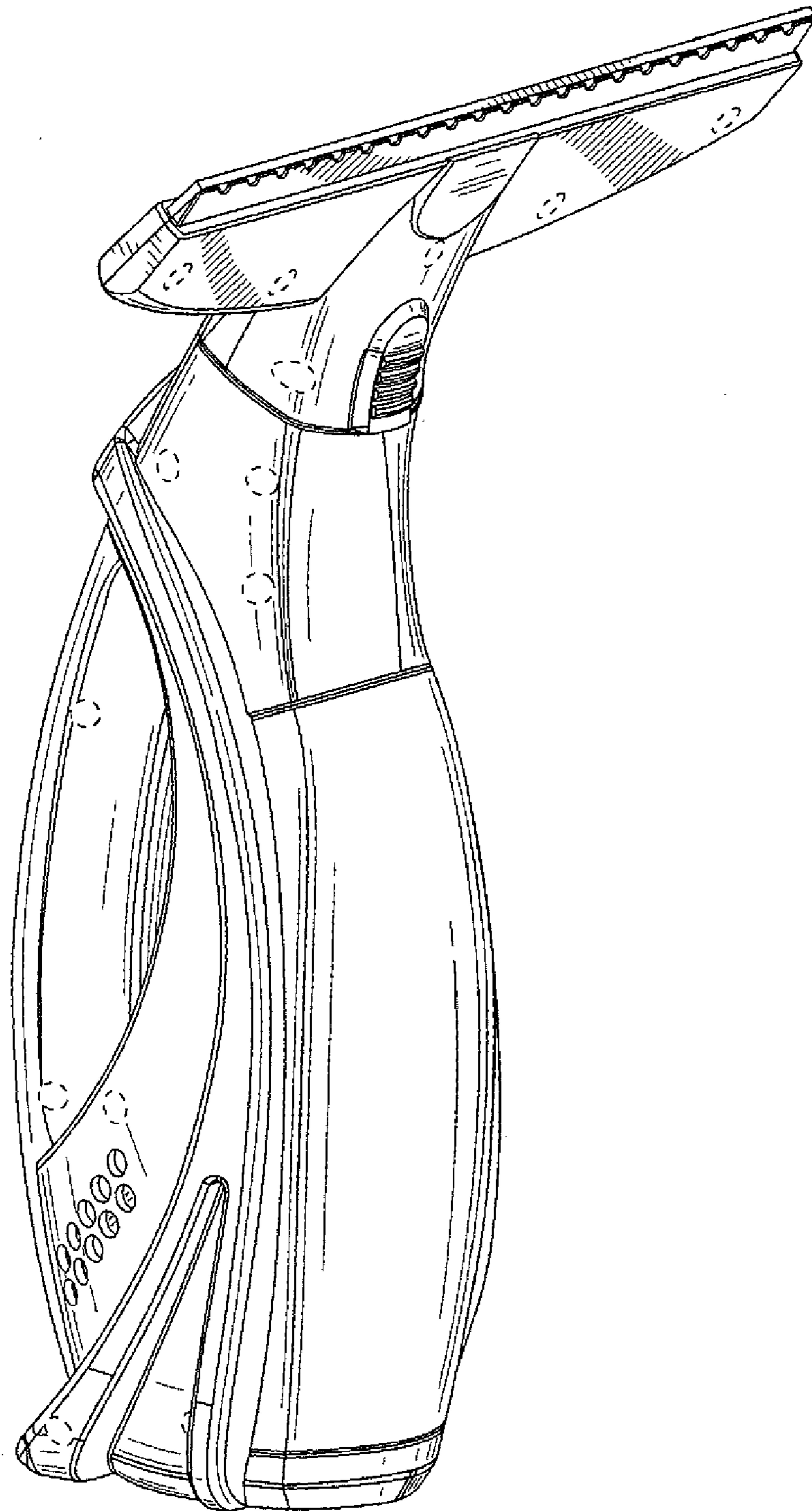

FIG. 2

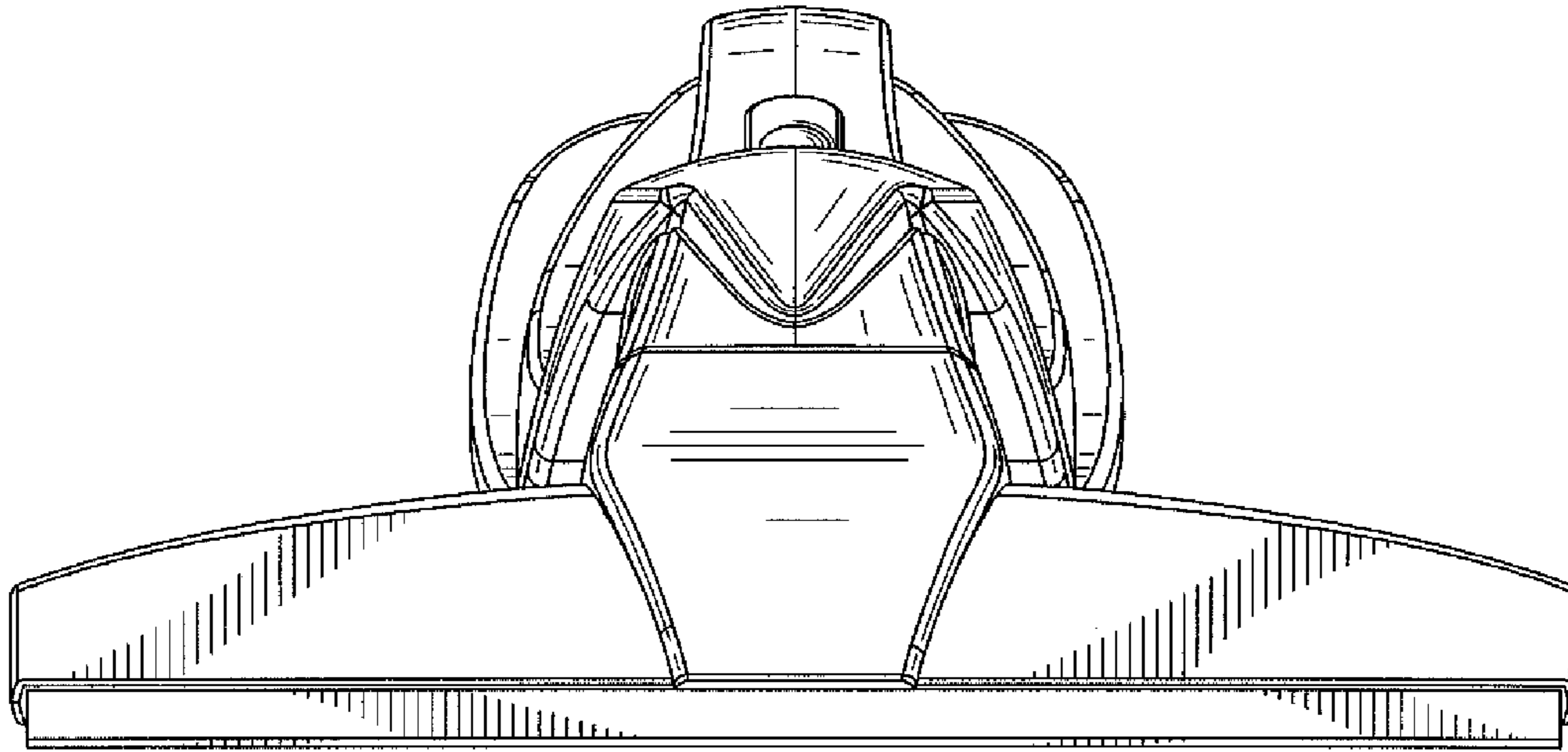

FIG. 3

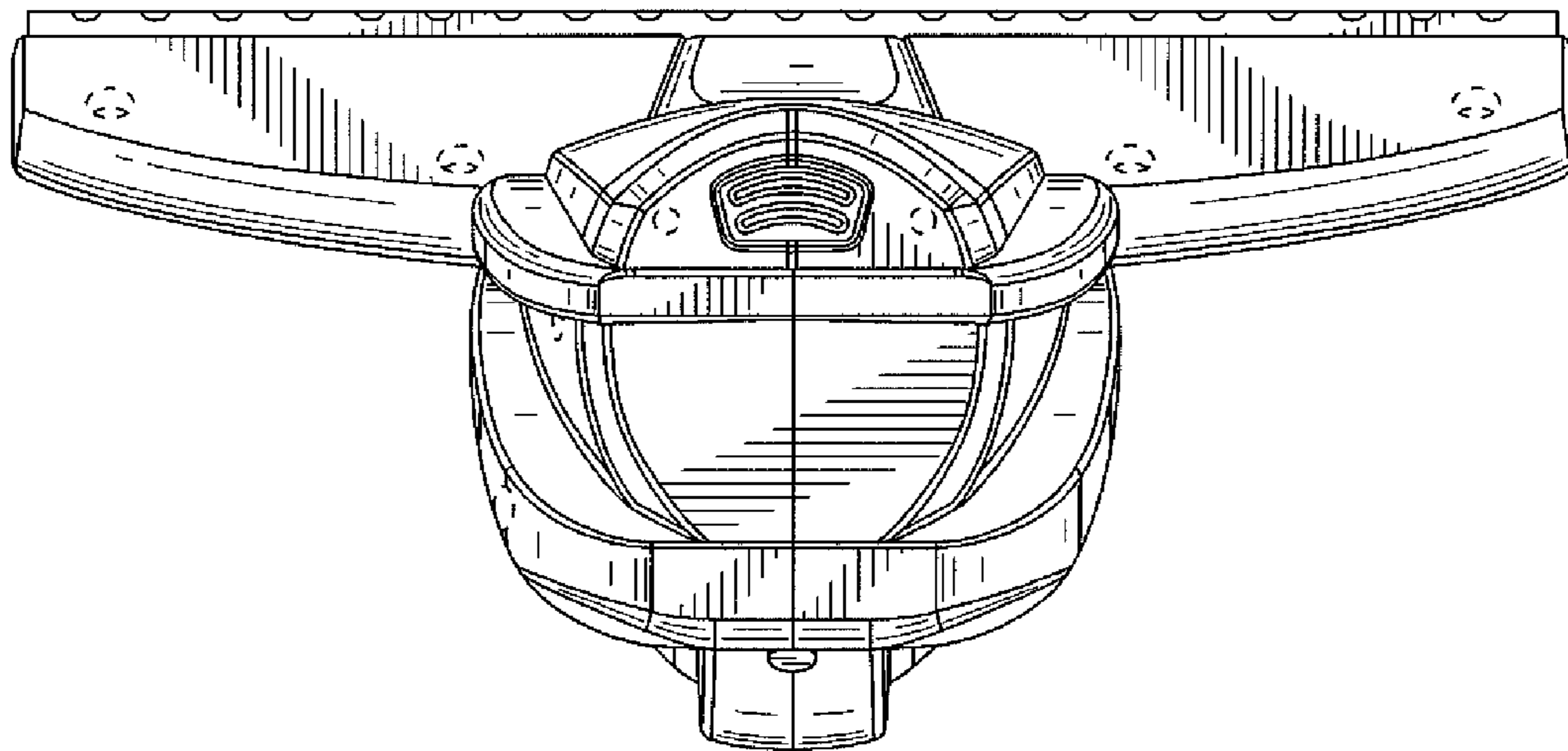

FIG. 4

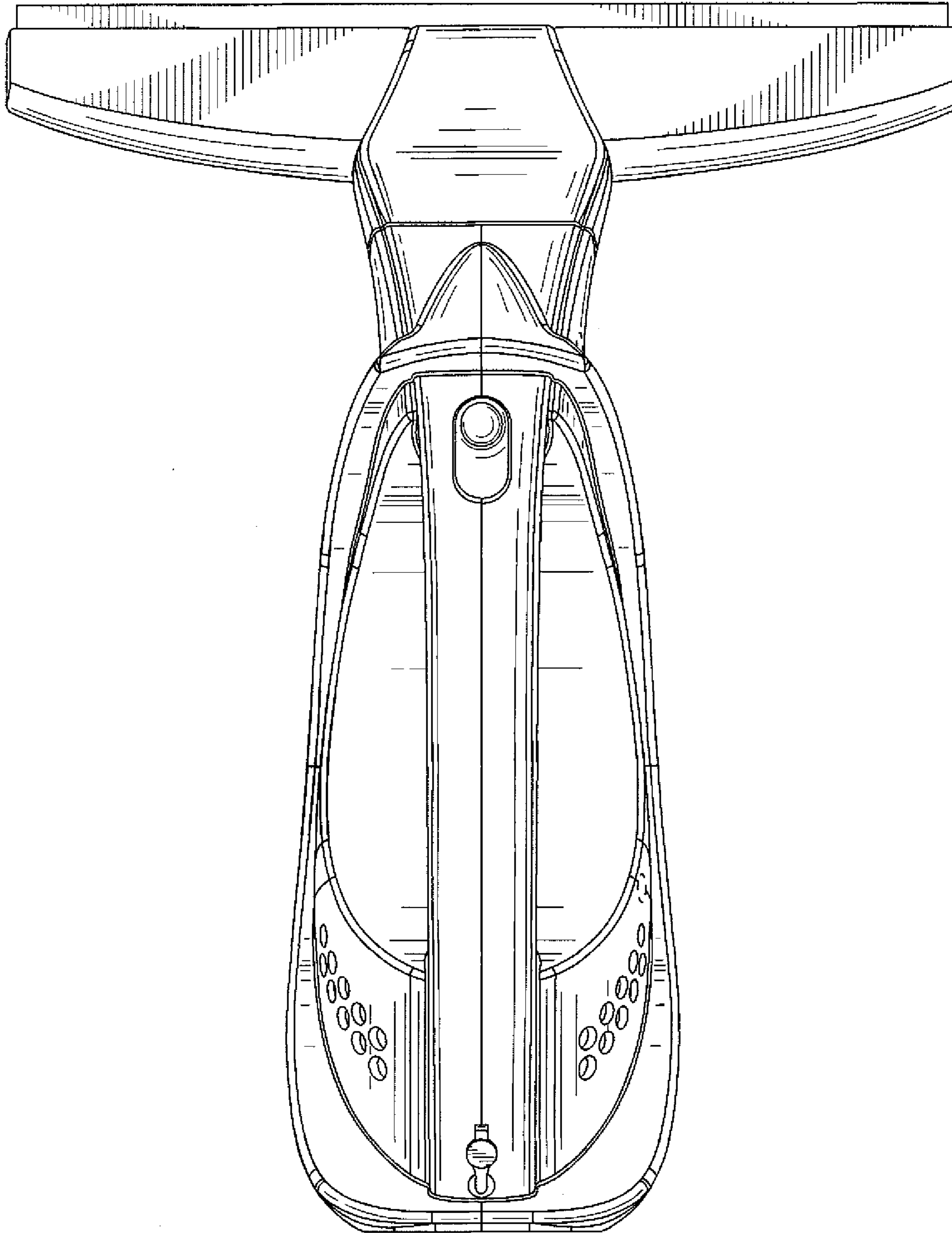

FIG. 5

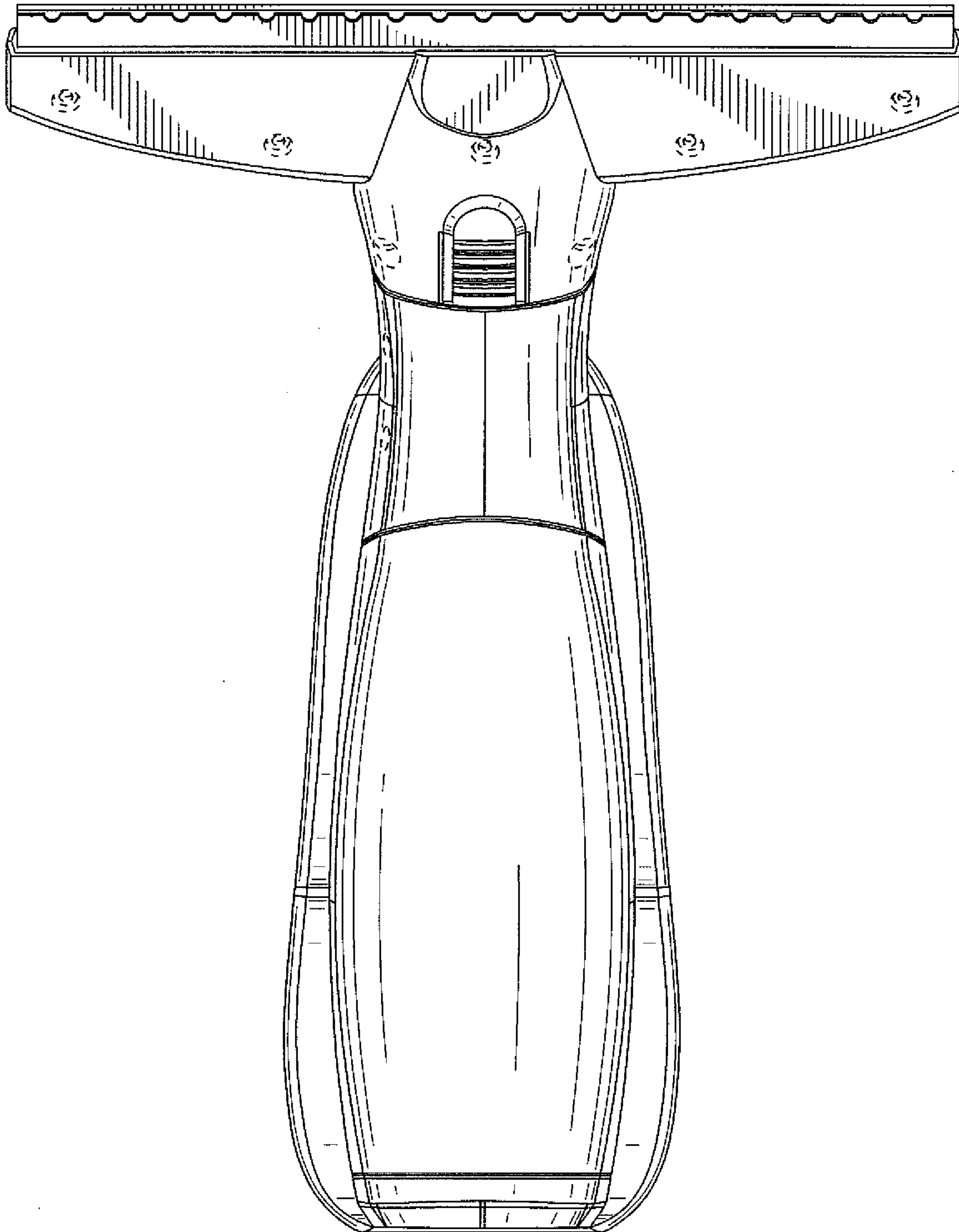

FIG. 6

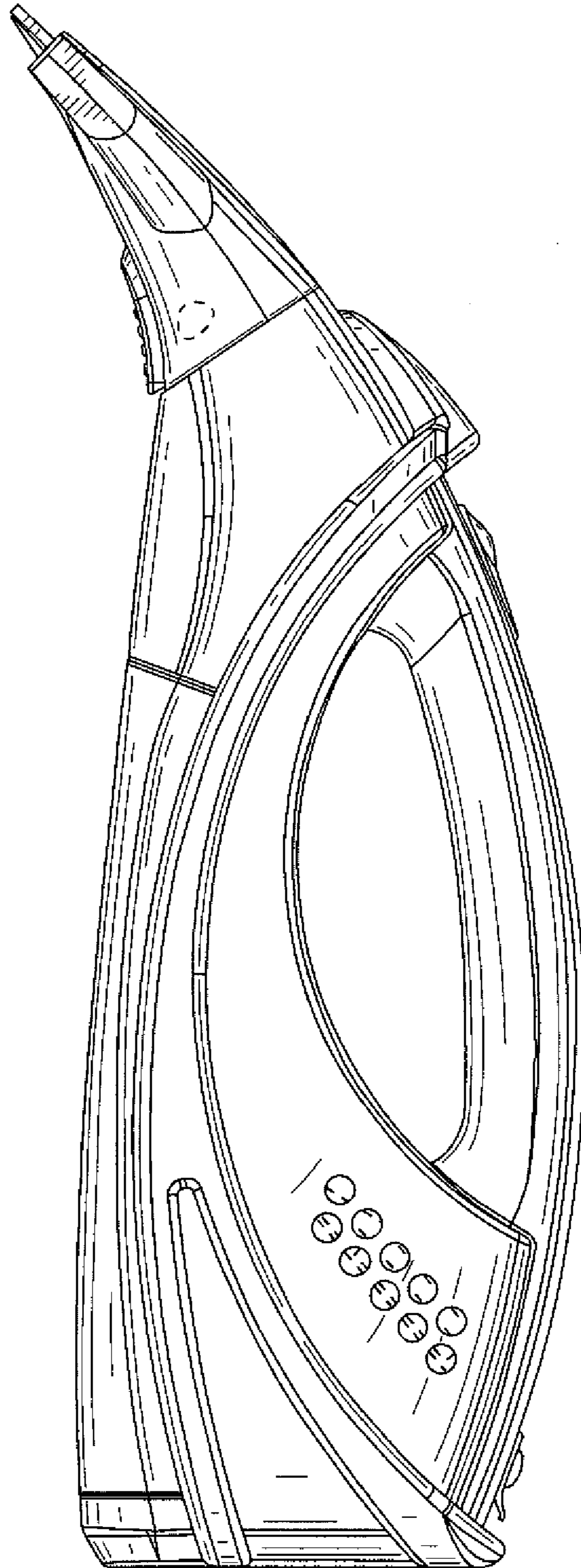

FIG. 7

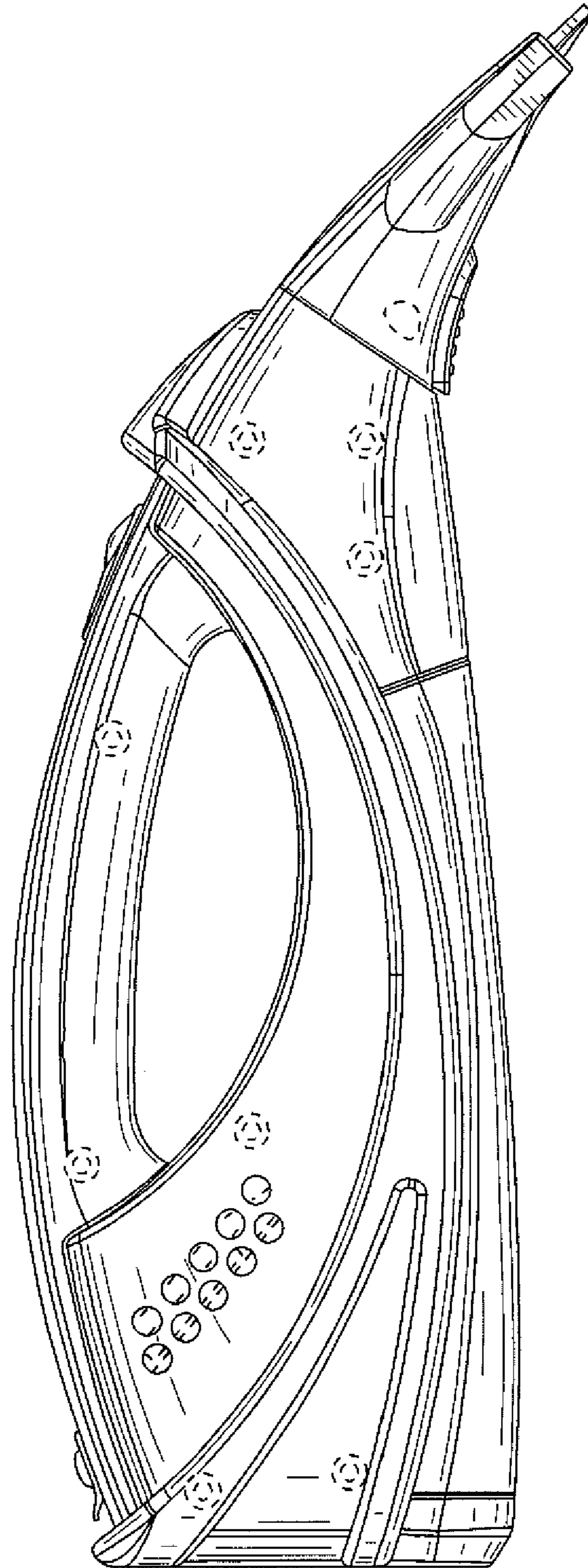

FIG. 8