



US00D734559S

(12) **United States Design Patent**
Noordzij et al.

(10) **Patent No.:** **US D734,559 S**
(45) **Date of Patent:** **** Jul. 14, 2015**

(54) **COMBINED VISOR AND MANDIBLE SHIELD**

(71) Applicant: **Artisent, LLC**, Simpson, PA (US)
(72) Inventors: **Duco W. Noordzij**, Roslindale, MA (US); **David C. Rogers**, Boston, MA (US); **Kyle L. Lamson**, Chelmsford, MA (US)

(73) Assignee: **ARTISENT, LLC**, Simpson, PA (US)

(**) Term: **14 Years**

(21) Appl. No.: **29/479,272**

(22) Filed: **Jan. 14, 2014**

(51) **LOC (10) Cl.** **29-02**

(52) **U.S. Cl.**
USPC **D29/110**

(58) **Field of Classification Search**
USPC D14/330, 206, 372; 2/426, 6.3, 427, 2/428, 430, 431, 432, 434, 435, 437, 439, 2/447, 452, 171.3; D24/157, 110.2, 3.3; D29/109, 105-107, 110; D16/100, D16/136, 217, 235, 300, 309-313, 321, 323, D16/325-327, 330, 336, 338-341; 351/153, 351/158, 243; 348/51, 53; 349/11; 455/344; D5/56, 11; D11/162, 85, 19, 4; D2/872, 876, 882, 893

See application file for complete search history.

(56) **References Cited**

U.S. PATENT DOCUMENTS

D367,664 S *	3/1996	Simioni	D16/309
D370,230 S *	5/1996	Simioni	D16/309
D551,279 S *	9/2007	Chen	D16/312
D594,895 S *	6/2009	Ross et al.	D16/309
D685,407 S *	7/2013	Lin et al.	D16/312
D697,546 S *	1/2014	Seo	D16/309

OTHER PUBLICATIONS

OPS-CORE 2012 Product Catalog; www.ops-core.com; Boston, MA, US; 44 pages; disclosed on or before Dec. 31, 2012.
OPS-CORE 2013 Product Catalog; www.ops-core.com; Boston, MA, US; 44 pages; first disclosed on Jan. 14, 2013.

* cited by examiner

Primary Examiner — Susan Hattan
Assistant Examiner — Eliza Bennett-Hattan

(74) *Attorney, Agent, or Firm* — Morgan, Lewis & Bockius LLP

(57) **CLAIM**

The ornamental design for a combined visor and mandible shield, as shown and described.

DESCRIPTION

FIG. 1 is a front perspective view of a combined visor and mandible shield in accordance with our new design; FIG. 2 is a front perspective view of a first portion of the combined visor and mandible shield shown in FIG. 1; FIG. 3 is a front perspective view of a second portion of the combined visor and mandible shield shown in FIG. 1; FIG. 4 is a front perspective view of a third portion of the combined visor and mandible shield shown in FIG. 1; FIG. 5 is a front elevational view of the combined visor and mandible shield shown in FIG. 1; FIG. 6 is a front elevational view of a first portion of the combined visor and mandible shield shown in FIG. 5; FIG. 7 is a front elevational view of a second portion of the combined visor and mandible shield shown in FIG. 5; FIG. 8 is a left-side elevational view of the combined visor and mandible shield shown in FIG. 1; FIG. 9 is a left-side elevational view of a first portion of the combined visor and mandible shield shown in FIG. 8; FIG. 10 is a left-side elevational view of a second portion of the combined visor and mandible shield shown in FIG. 8; FIG. 11 is a right-side elevational view of the combined visor and mandible shield shown in FIG. 1; FIG. 12 is a rear elevational view of the combined visor and mandible shield shown in FIG. 1; FIG. 13 is a rear elevational view of a portion of the combined visor and mandible shield shown in FIG. 12; FIG. 14 is a top plan view of the combined visor and mandible shield shown in FIG. 1; FIG. 15 is a top plan view of a portion of the combined visor and mandible shield shown in FIG. 14; FIG. 16 is a bottom plan view of the combined visor and mandible shield shown in FIG. 1; and, FIG. 17 is a bottom plan view of a portion of the combined visor and mandible shield shown in FIG. 16. The broken lines shown in the drawings represent portions of the combined visor and mandible shield that form no part of the claimed design.

1 Claim, 17 Drawing Sheets

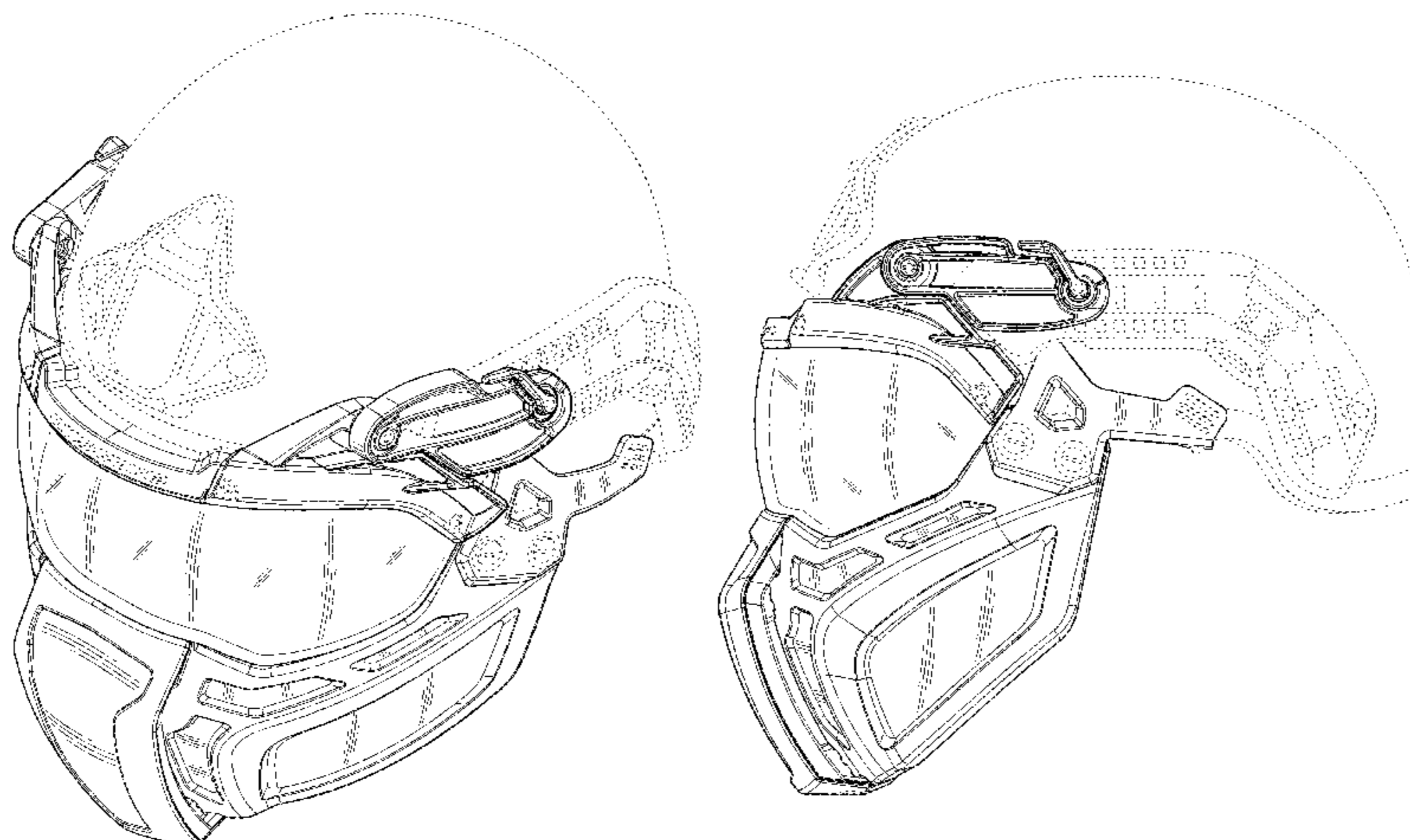

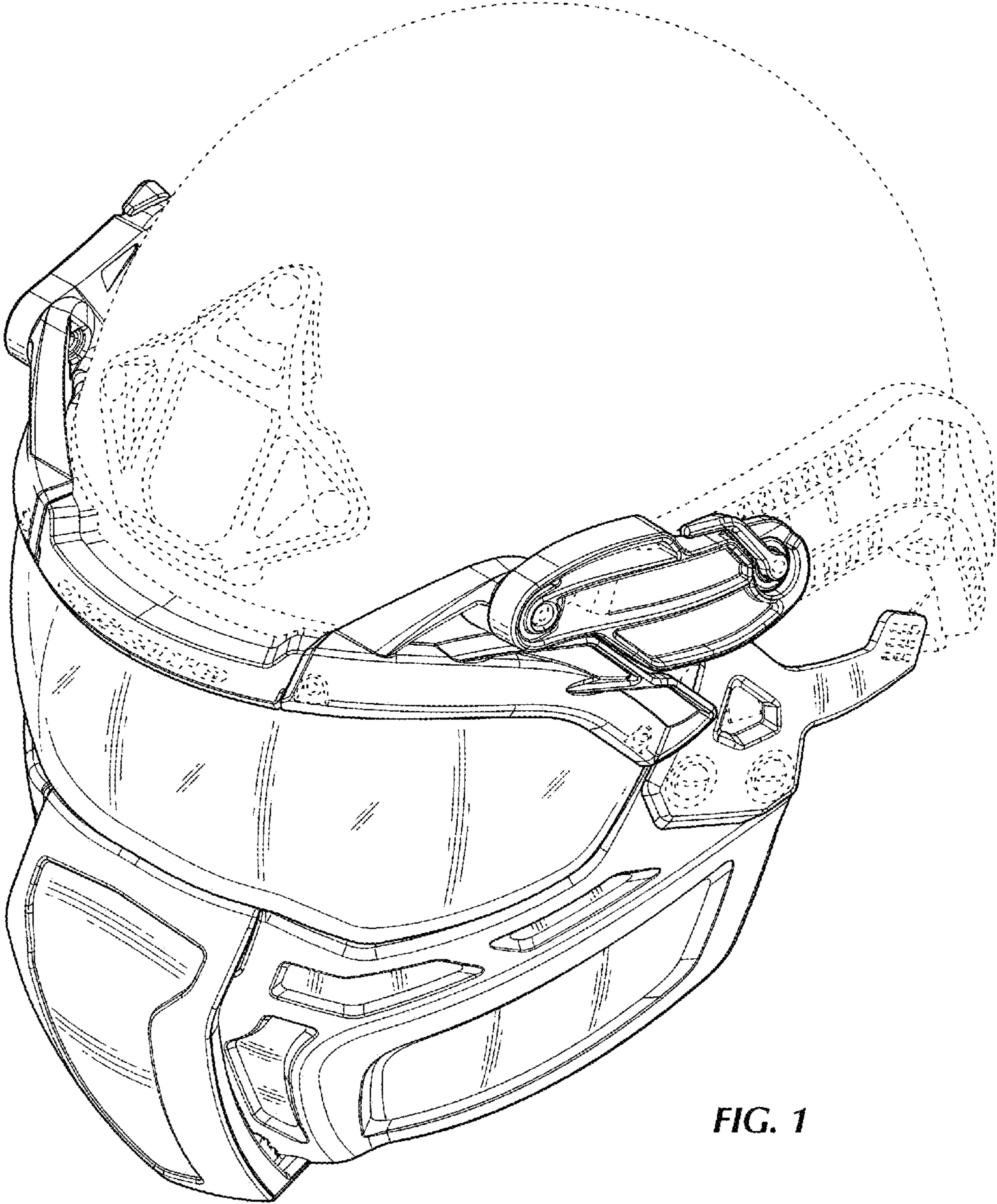

FIG. 1

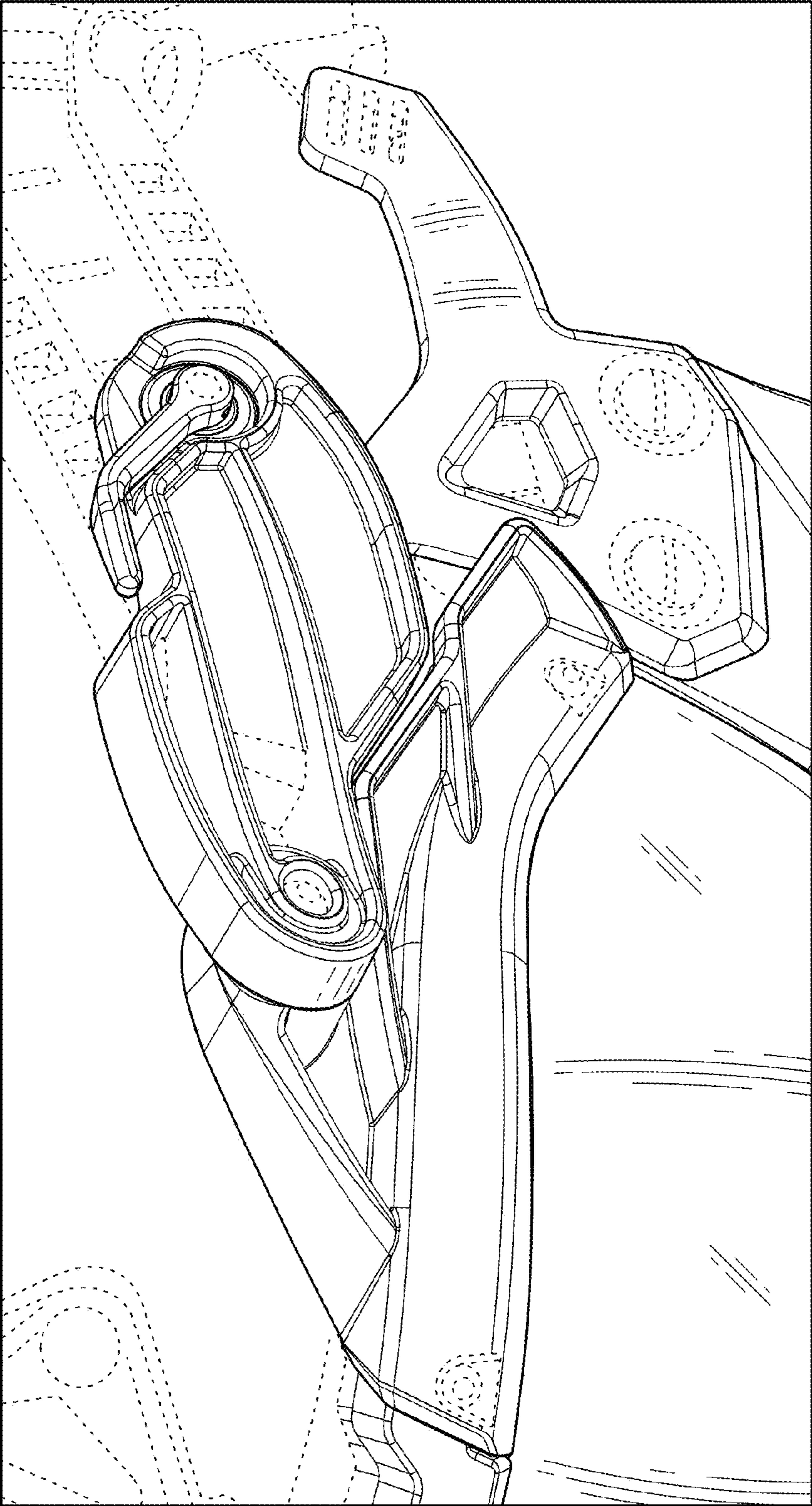

FIG. 2

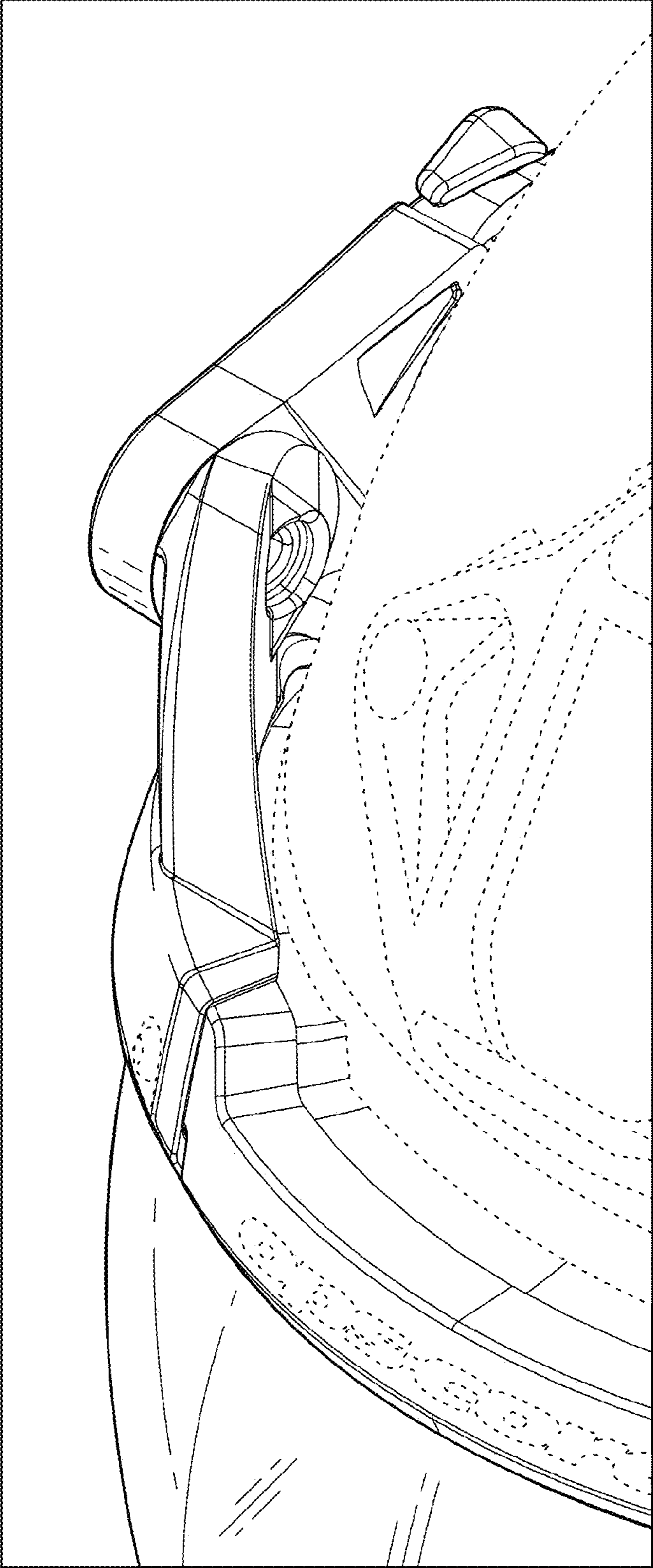

FIG. 3

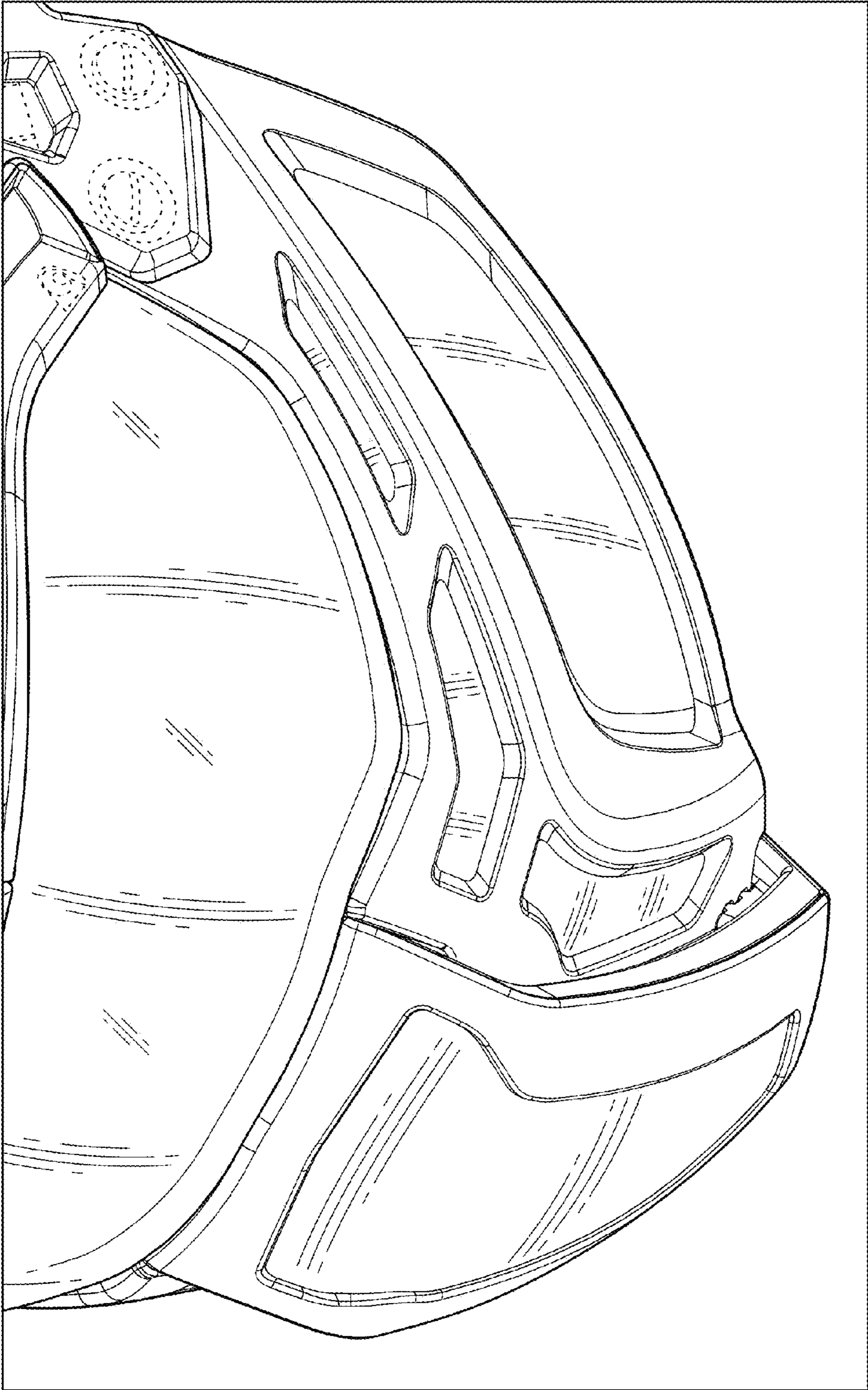

FIG. 4

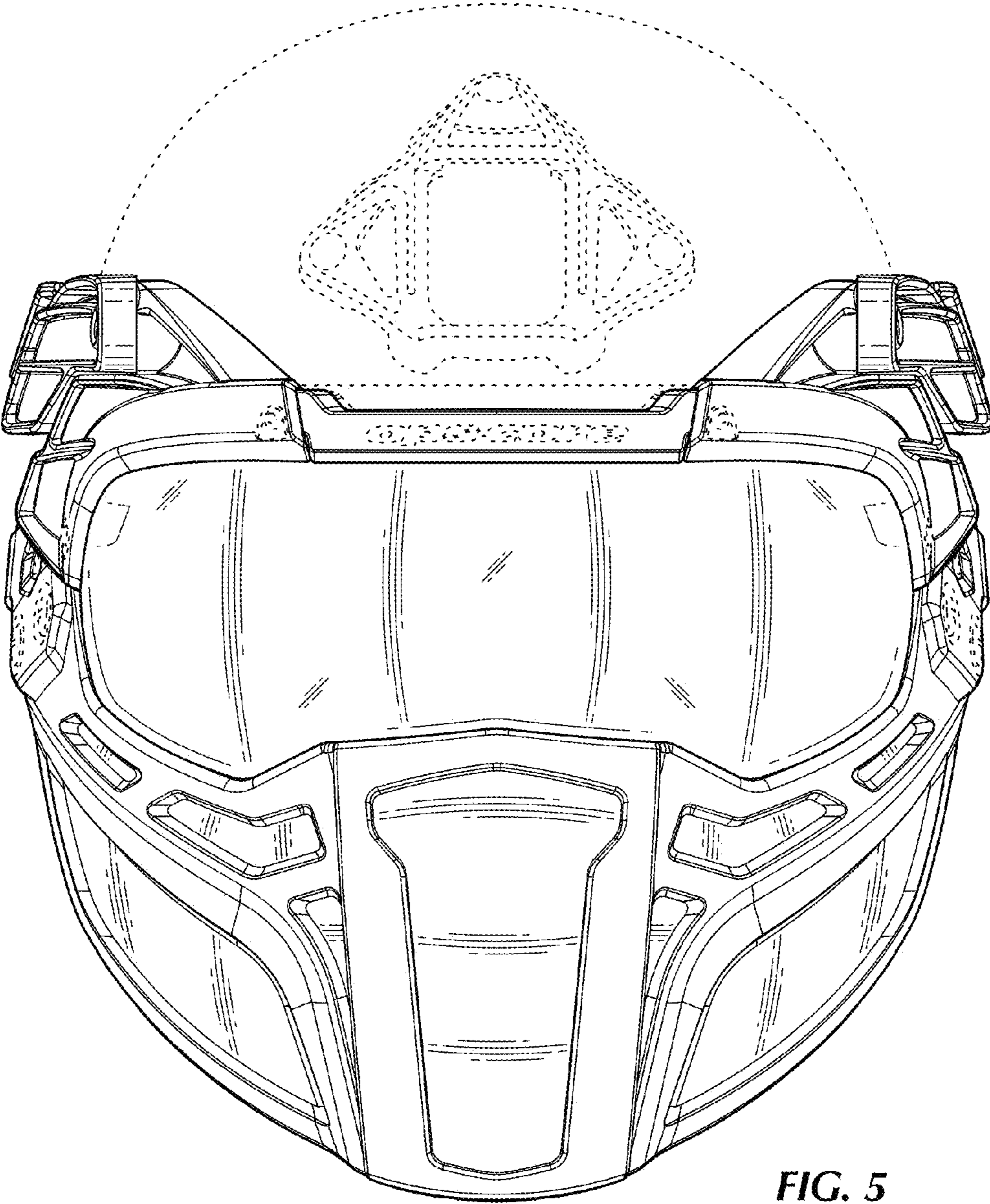

FIG. 5

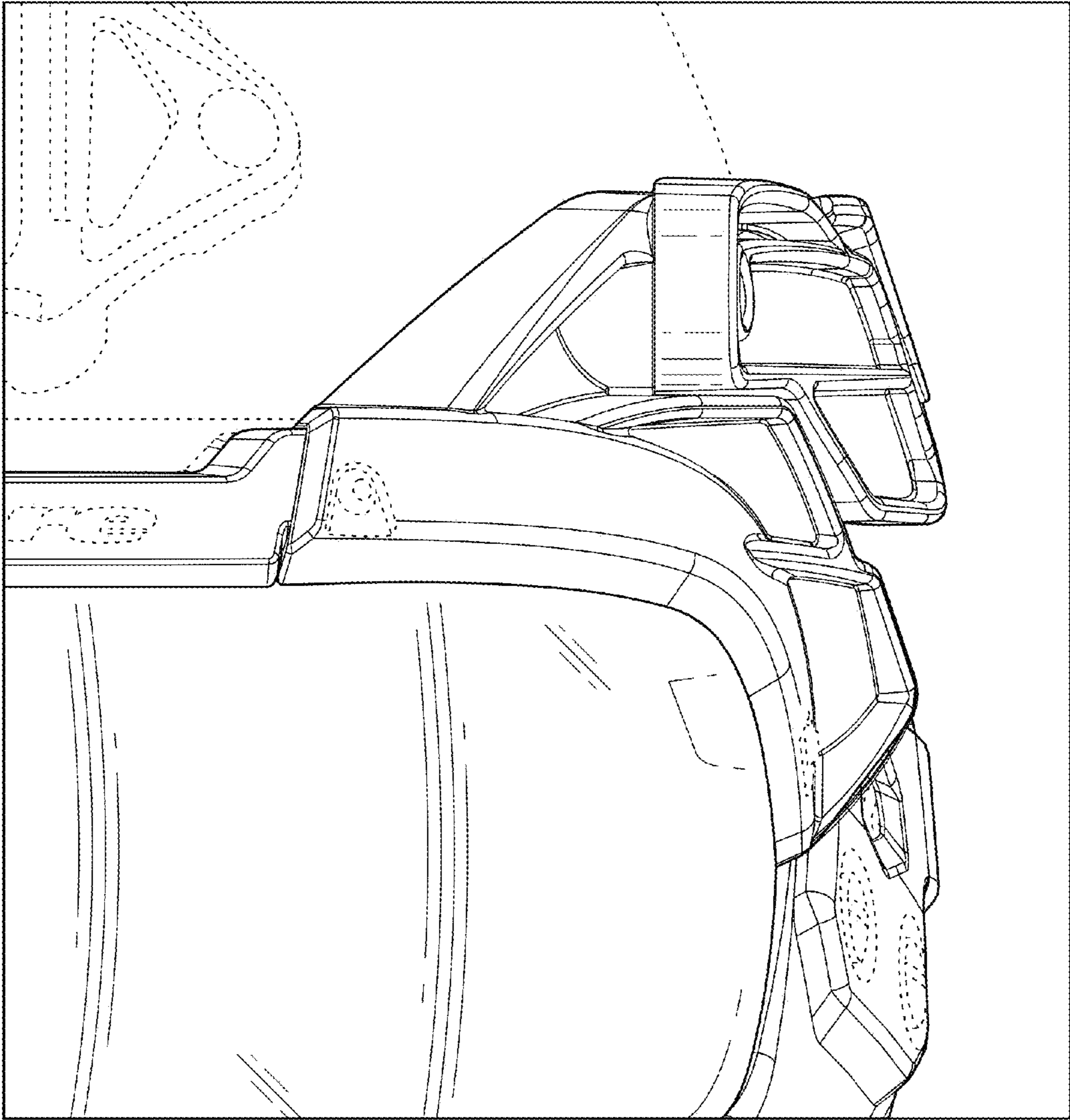

FIG. 6

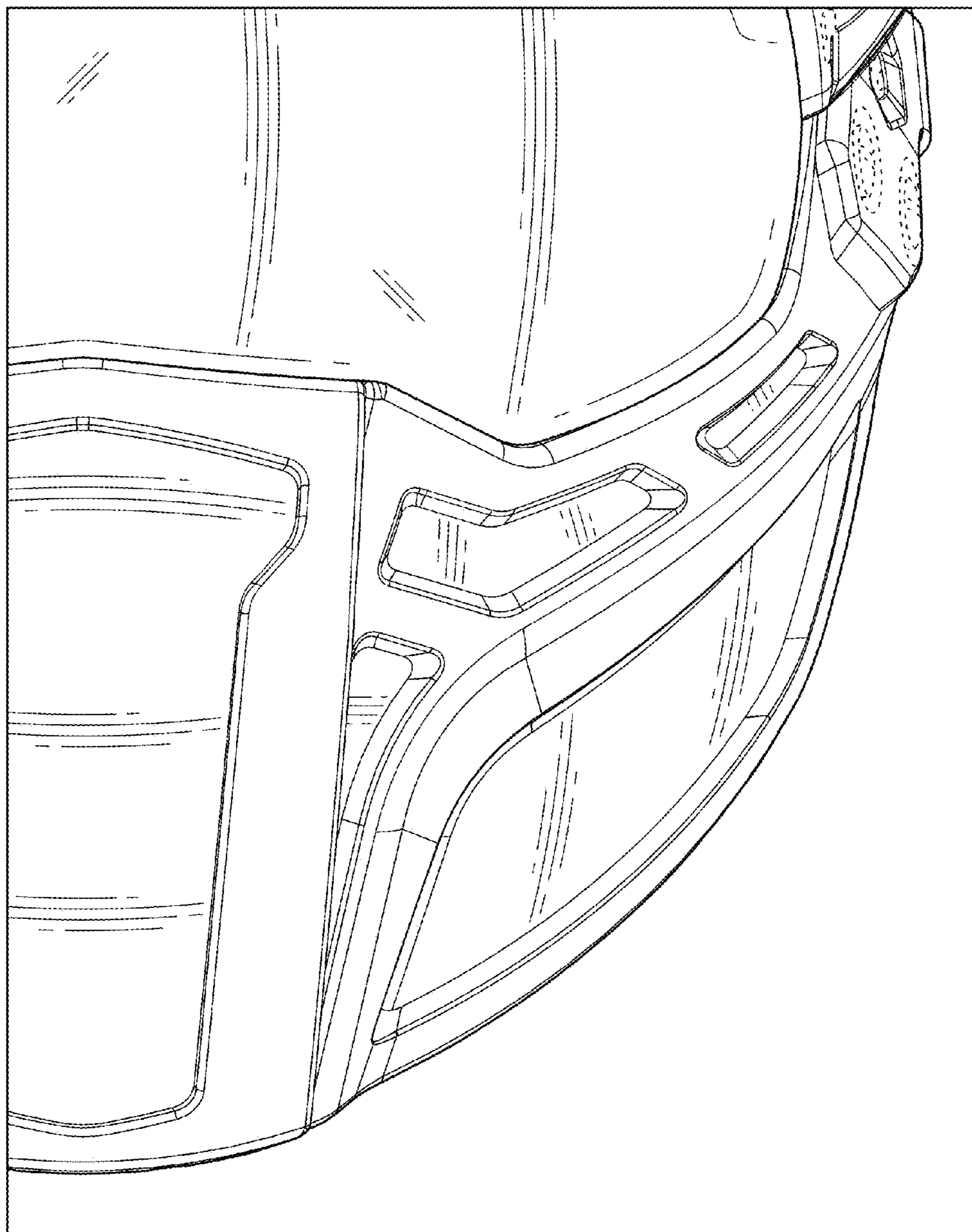

FIG. 7

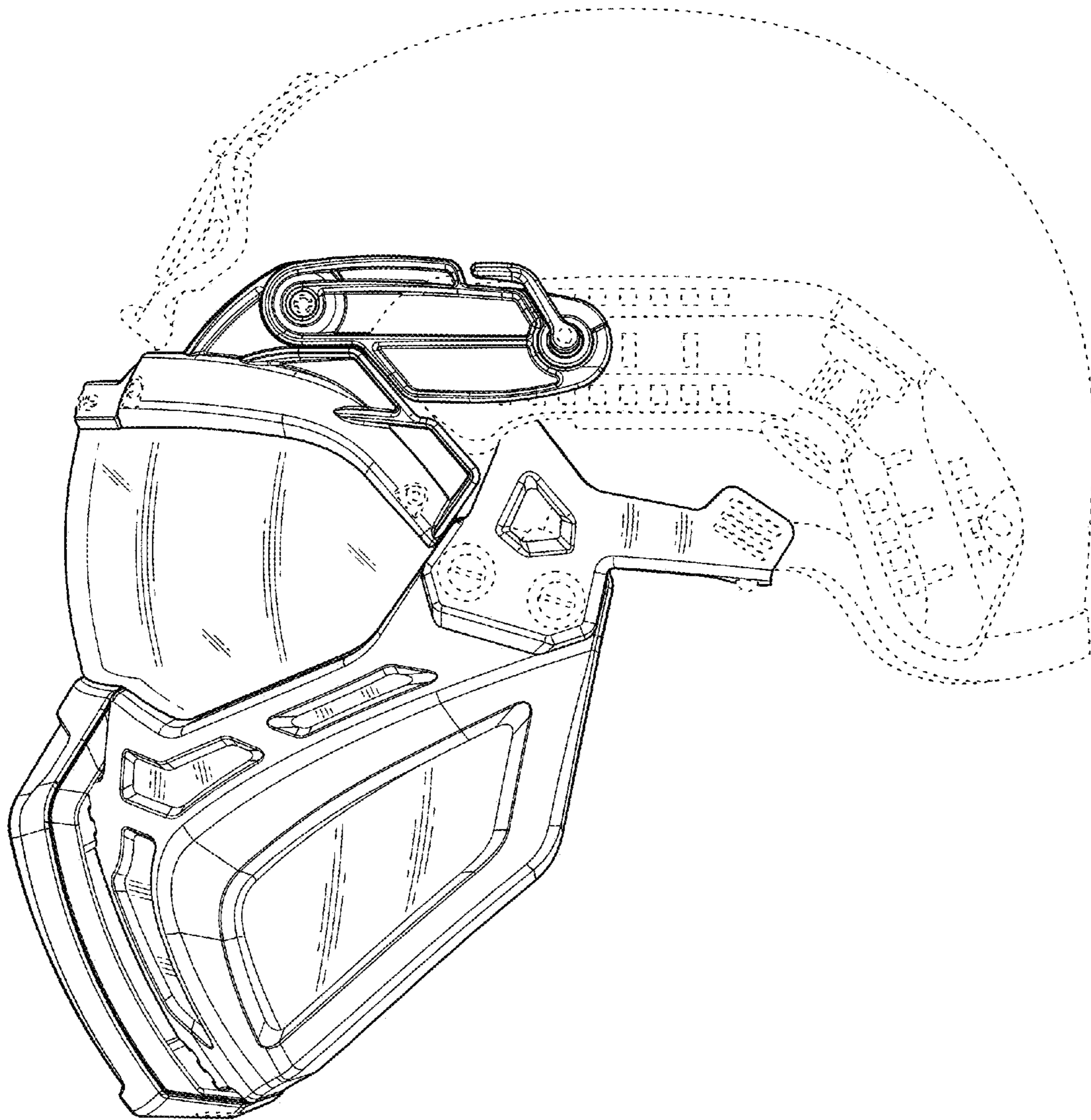

FIG. 8

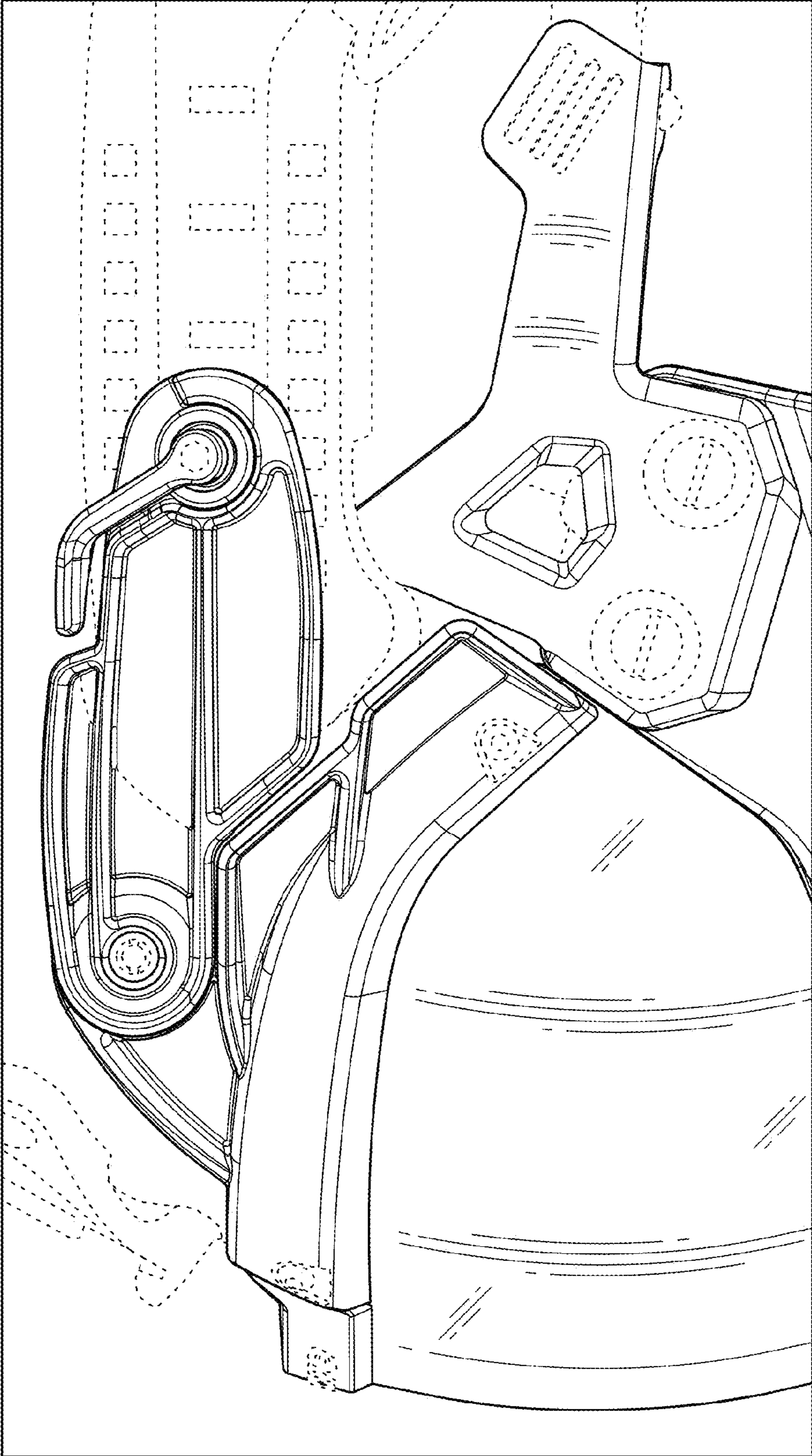

FIG. 9

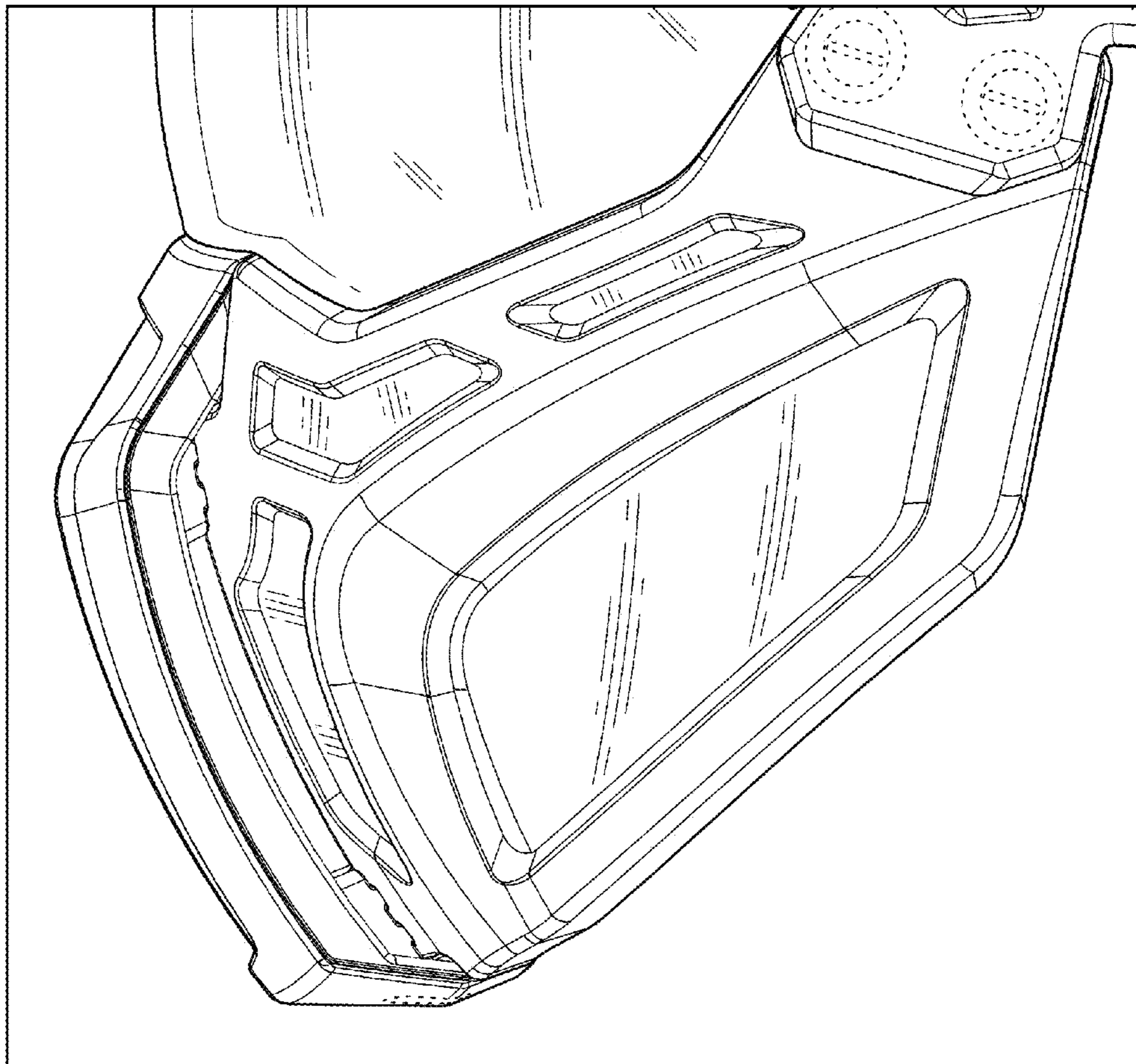

FIG. 10

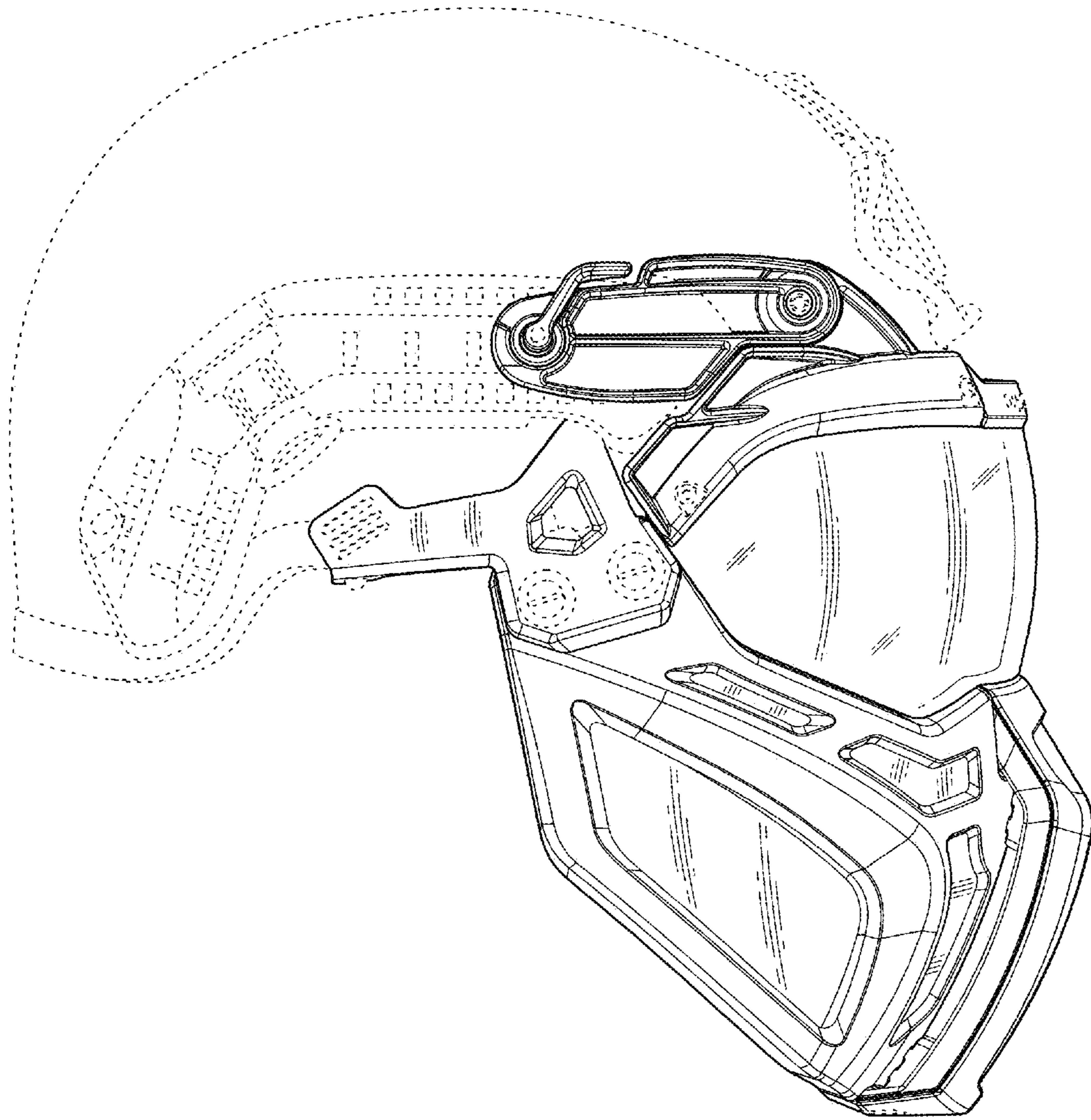

FIG. 11

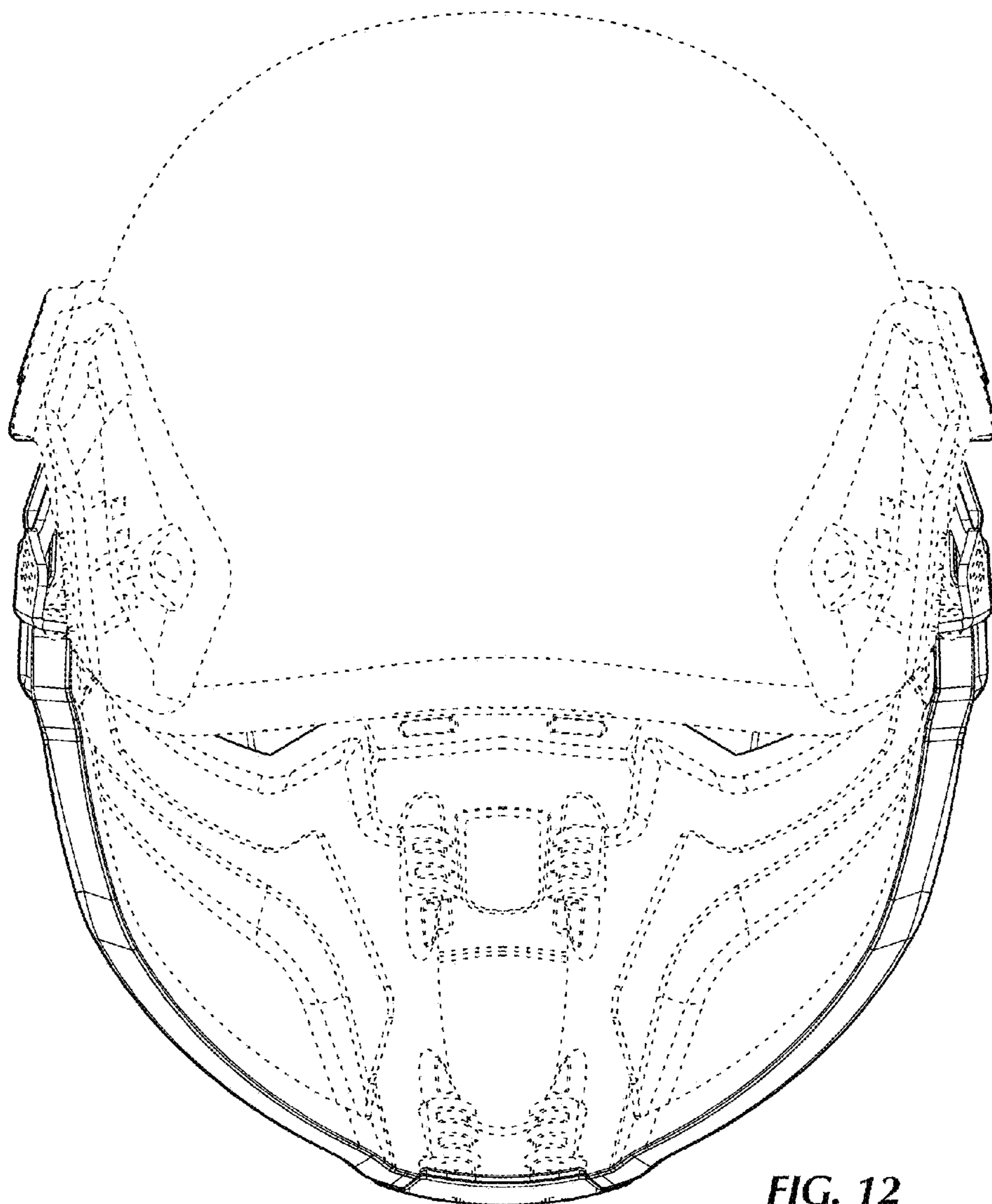

FIG. 12

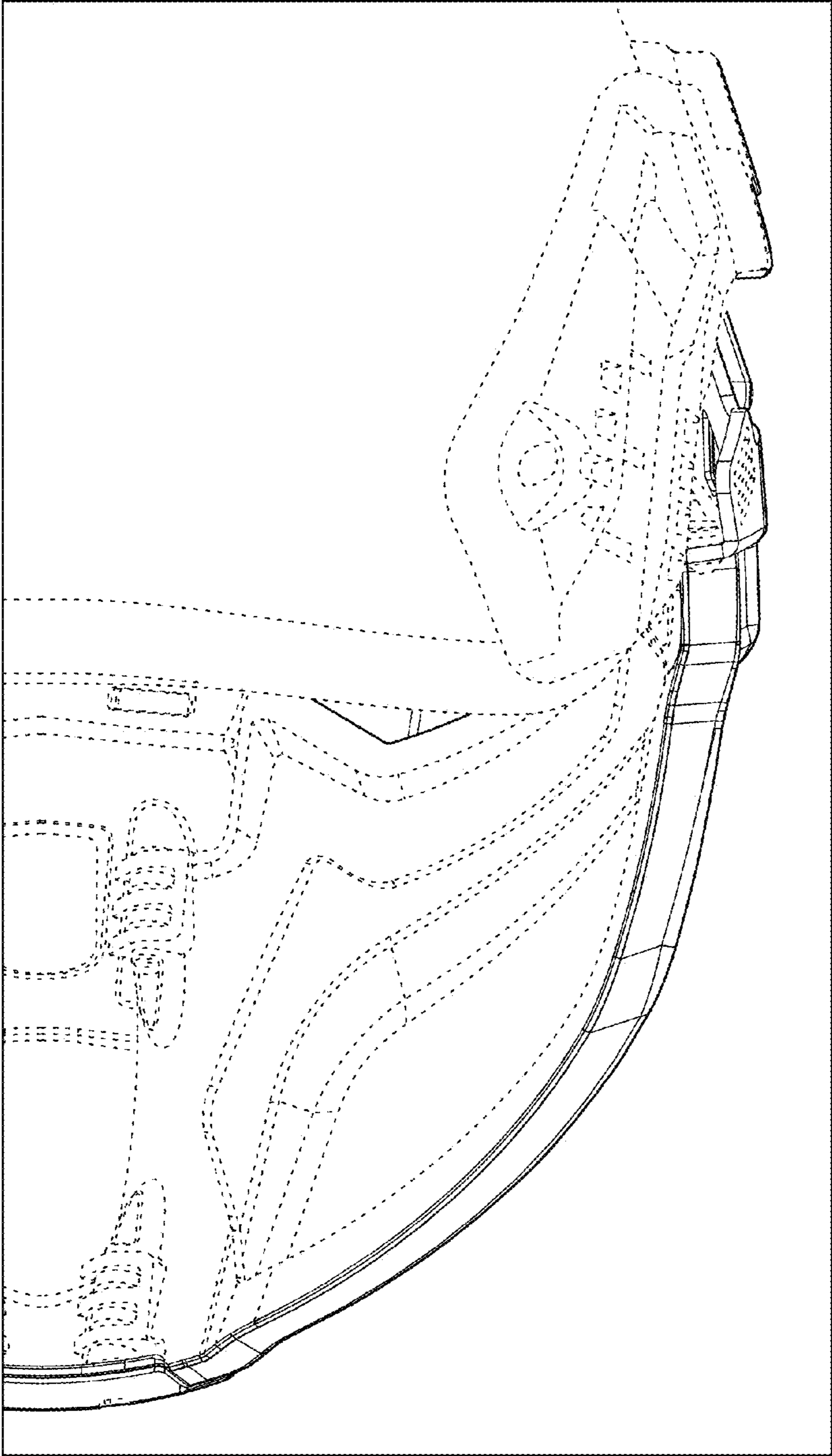

FIG. 13

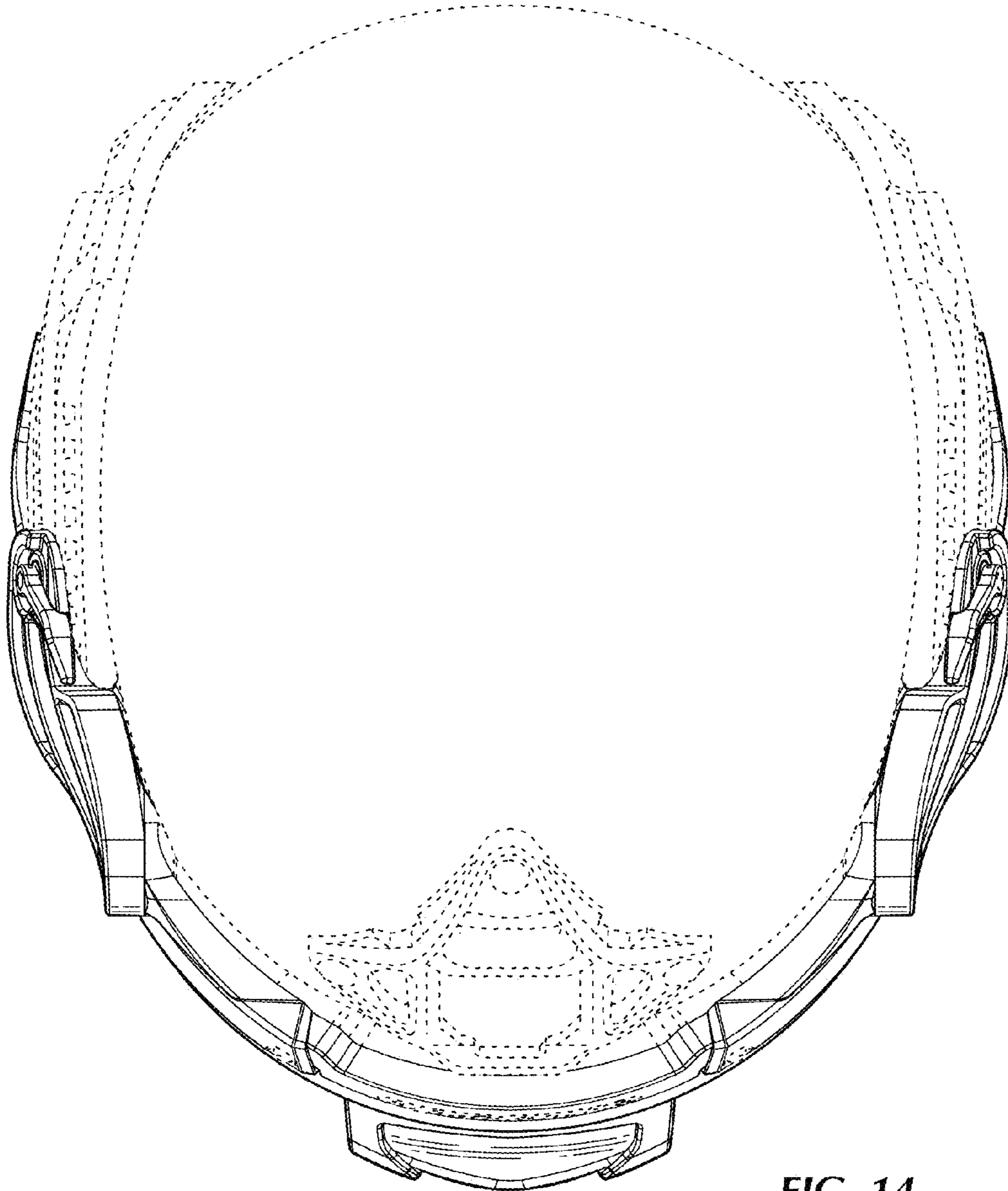

FIG. 14

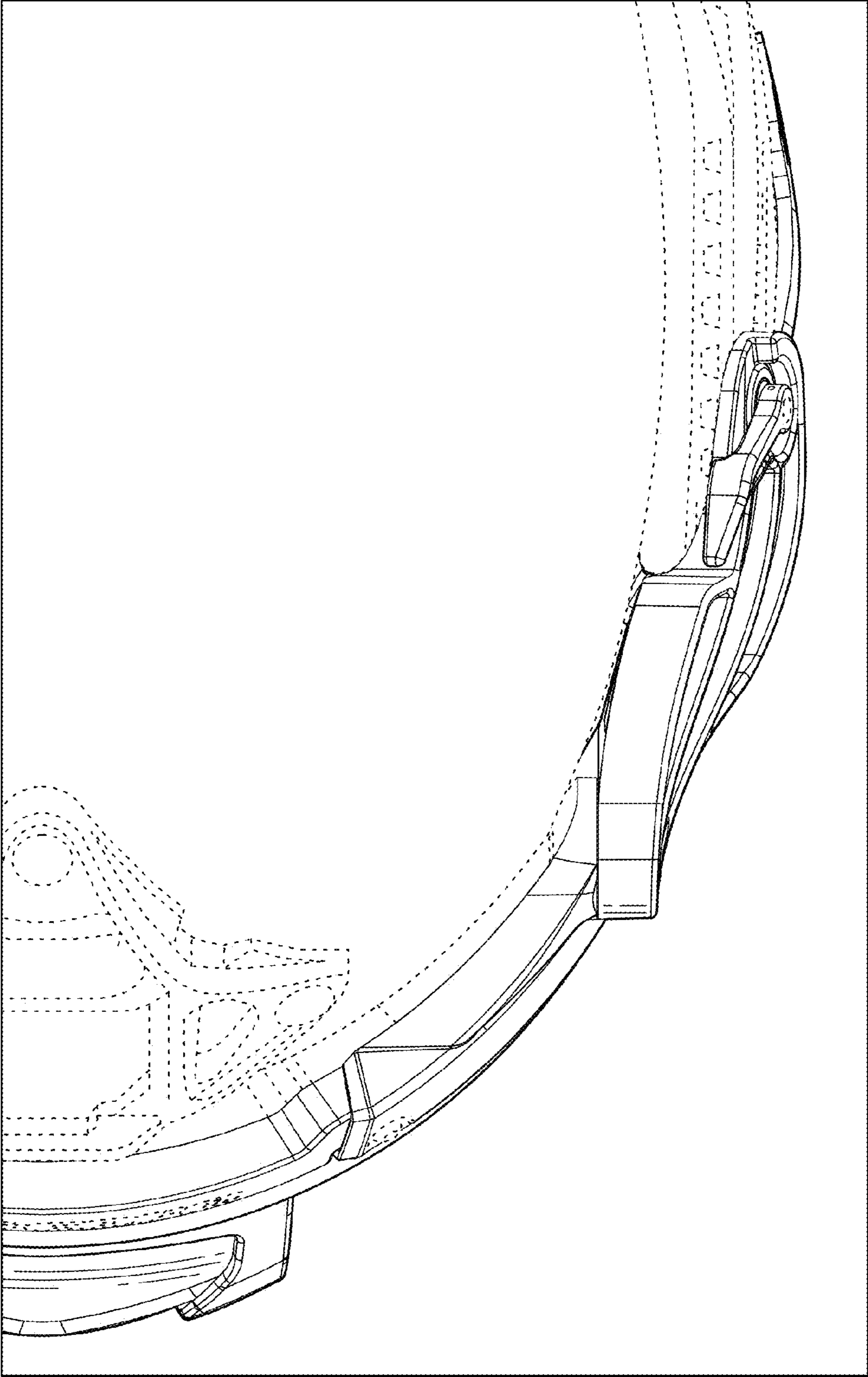

FIG. 15

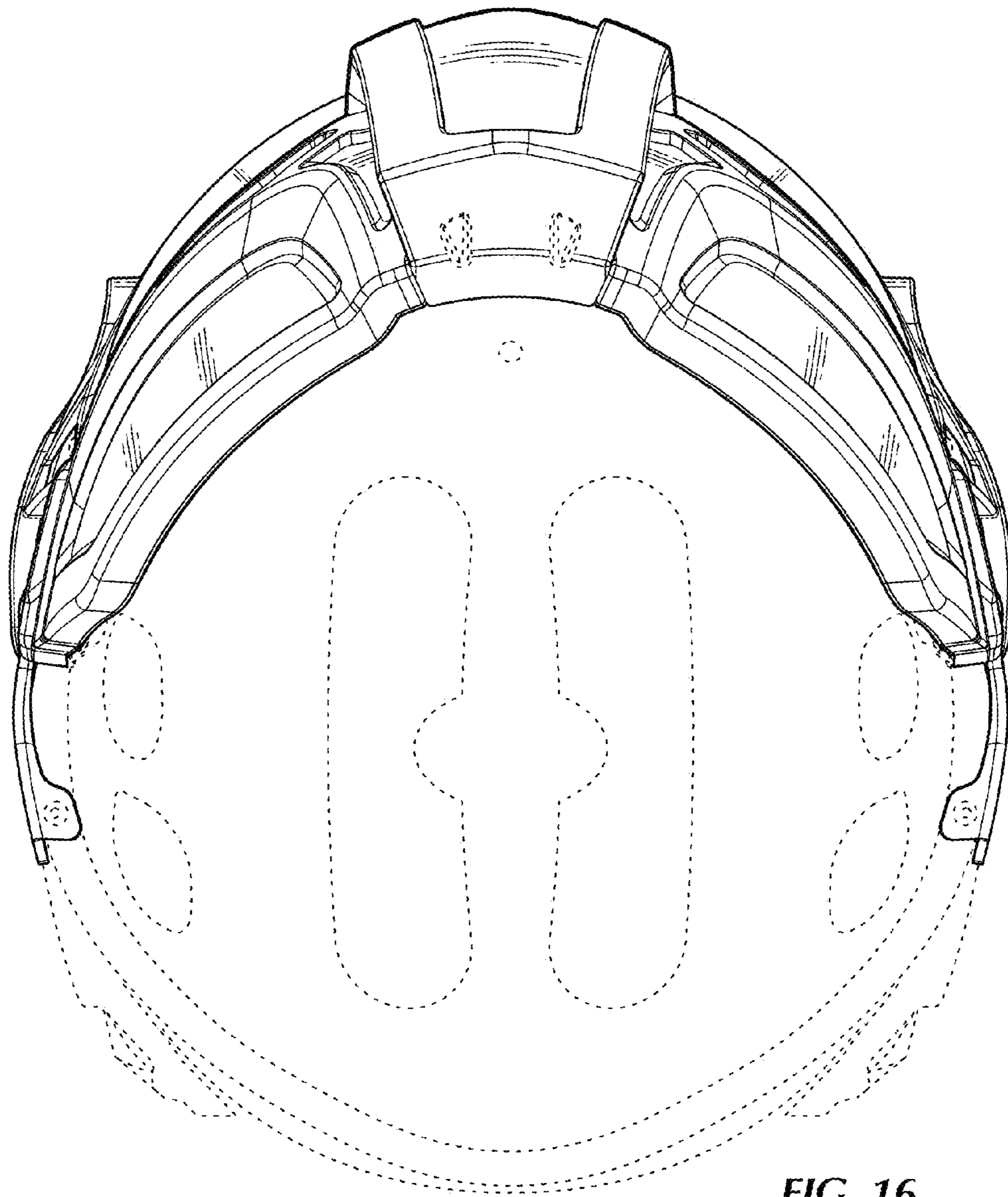

FIG. 16

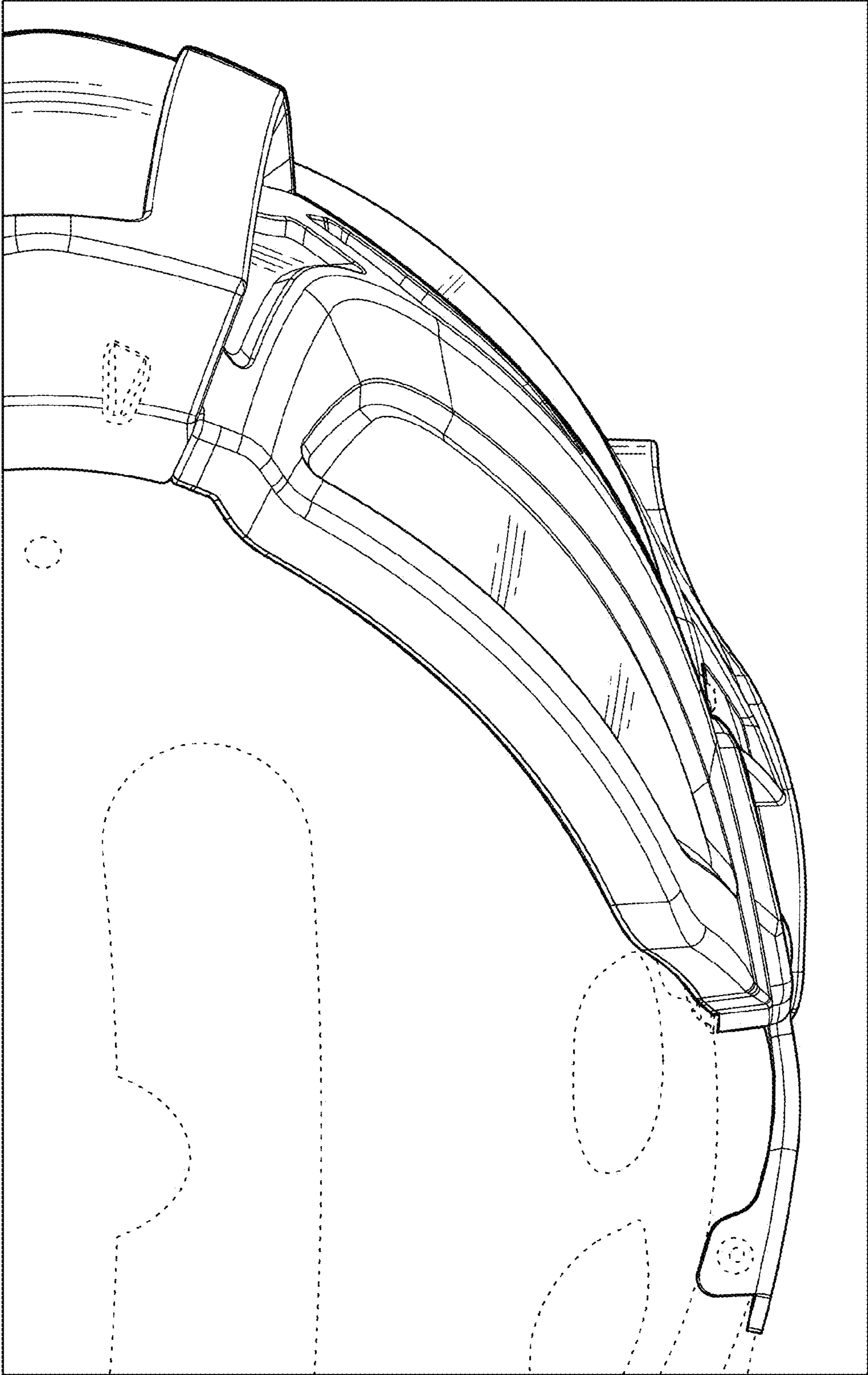

FIG. 17