



US00D734533S

(12) **United States Design Patent**  
**Lovegrove**

(10) **Patent No.:** **US D734,533 S**  
(45) **Date of Patent:** **\*\* Jul. 14, 2015**

(54) **LAMP HEAD**

(71) Applicant: **Artemide S.p.A.**, Milan (IT)

(72) Inventor: **Ross Lovegrove**, Milan (IT)

(73) Assignee: **ARTEMIDE S.p.A.**, Milan (IT)

(\*\*) Term: **14 Years**

(21) Appl. No.: **29/504,576**

(22) Filed: **Oct. 7, 2014**

(30) **Foreign Application Priority Data**

Apr. 7, 2014 (EM) ..... 002441618-0008

Apr. 7, 2014 (EM) ..... 002441618-0009

(51) **LOC (10) Cl.** ..... **26-99**

(52) **U.S. Cl.**  
USPC ..... **D26/118**; D26/87; D26/93

(58) **Field of Classification Search**  
USPC ..... D26/73, 87, 93-101, 118; 362/147,  
362/410, 412, 431, 432, 806  
See application file for complete search history.

(56) **References Cited**

**U.S. PATENT DOCUMENTS**

D37,809 S *	2/1906	Mygatt	.....	D26/88
D61,360 S *	8/1922	Blackwell	.....	D26/88
D62,073 S *	3/1923	Tomlinson	.....	D26/88
D65,920 S *	11/1924	Monroe	.....	D26/87
D73,631 S *	10/1927	Wolter	.....	D26/24
D125,317 S *	2/1941	Sabatini	.....	D26/88
D152,336 S *	1/1949	Hirshfield	.....	D26/87
D167,559 S *	8/1952	Burton	.....	D26/93
D408,573 S *	4/1999	Kay	.....	D26/68
D415,587 S *	10/1999	Chiang	.....	D26/87
D422,375 S *	4/2000	Milicia	.....	D26/88
D468,052 S *	12/2002	Kitras	.....	D26/129

D536,478 S *	2/2007	McMinn	.....	D26/118
D544,637 S *	6/2007	McMinn	.....	D26/118
D559,427 S *	1/2008	Zupan	.....	D26/88
D567,427 S *	4/2008	Wanders	.....	D26/88
D585,583 S *	1/2009	Campbell	.....	D26/88

(Continued)

*Primary Examiner* — Clare E Heflin

(74) *Attorney, Agent, or Firm* — Venable LLP; Robert Kinberg

(57) **CLAIM**

The ornamental design for a lamp head, as shown and described.

**DESCRIPTION**

FIG. 1 is a perspective view of a lamp head, according to an embodiment of the invention;  
 FIG. 2 is a front view of a lamp head, according to FIG. 1;  
 FIG. 3 is a rear view of a lamp head, according to FIG. 1;  
 FIG. 4 is a right side view of a lamp head, according to FIG. 1;  
 FIG. 5 is a left side view of a lamp head, according to FIG. 1;  
 FIG. 6 is a top view of a lamp head, according to FIG. 1; and  
 FIG. 7 is a bottom view of a lamp head, according to FIG. 1.  
 FIG. 8 is a perspective view of a lamp head, according to an embodiment of the invention;  
 FIG. 9 is a front view of a lamp head, according to FIG. 8;  
 FIG. 10 is a rear view of a lamp head, according to FIG. 8;  
 FIG. 11 is a left side view of a lamp head, according to FIG. 8;  
 FIG. 12 is a right side view of a lamp head, according to FIG. 8;  
 FIG. 13 is a top view of a lamp head, according to FIG. 8; and  
 FIG. 14 is a bottom view of a lamp head, according to FIG. 8.  
 The broken lines in the drawing show environmental structure that forms no part of the claimed design.

**1 Claim, 14 Drawing Sheets**

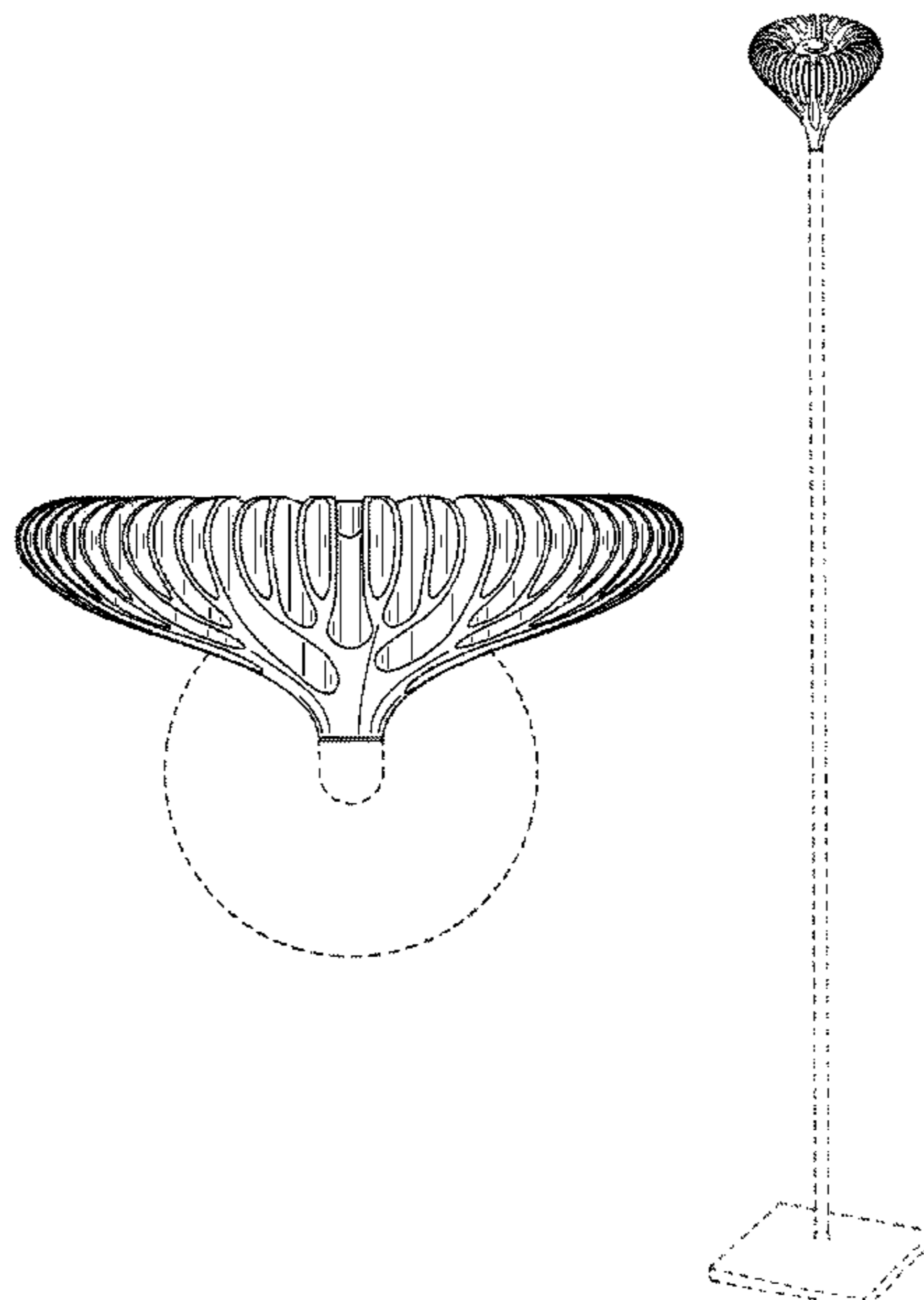

(56)

**References Cited**

U.S. PATENT DOCUMENTS

D614,797 S \* 4/2010 Sabernig ..... D26/93  
D619,295 S \* 7/2010 Lee ..... D26/104  
D620,182 S \* 7/2010 Sabernig ..... D26/88

D633,248 S \* 2/2011 Alexander et al. .... D26/118  
D656,663 S \* 3/2012 Son ..... D26/118  
D664,280 S \* 7/2012 Campbell ..... D26/88  
D668,376 S \* 10/2012 Urquiola ..... D26/118

\* cited by examiner

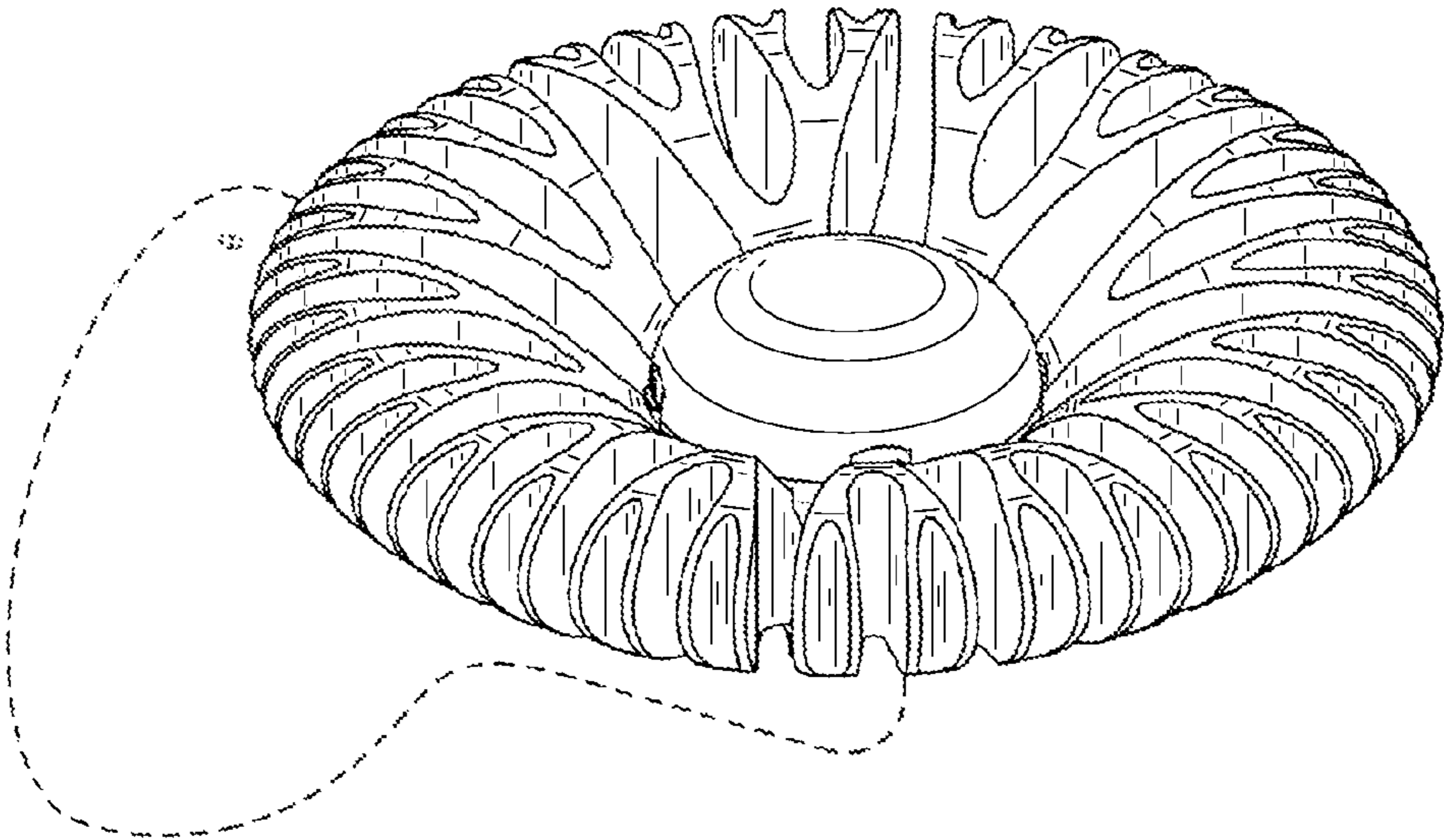

FIG. 1

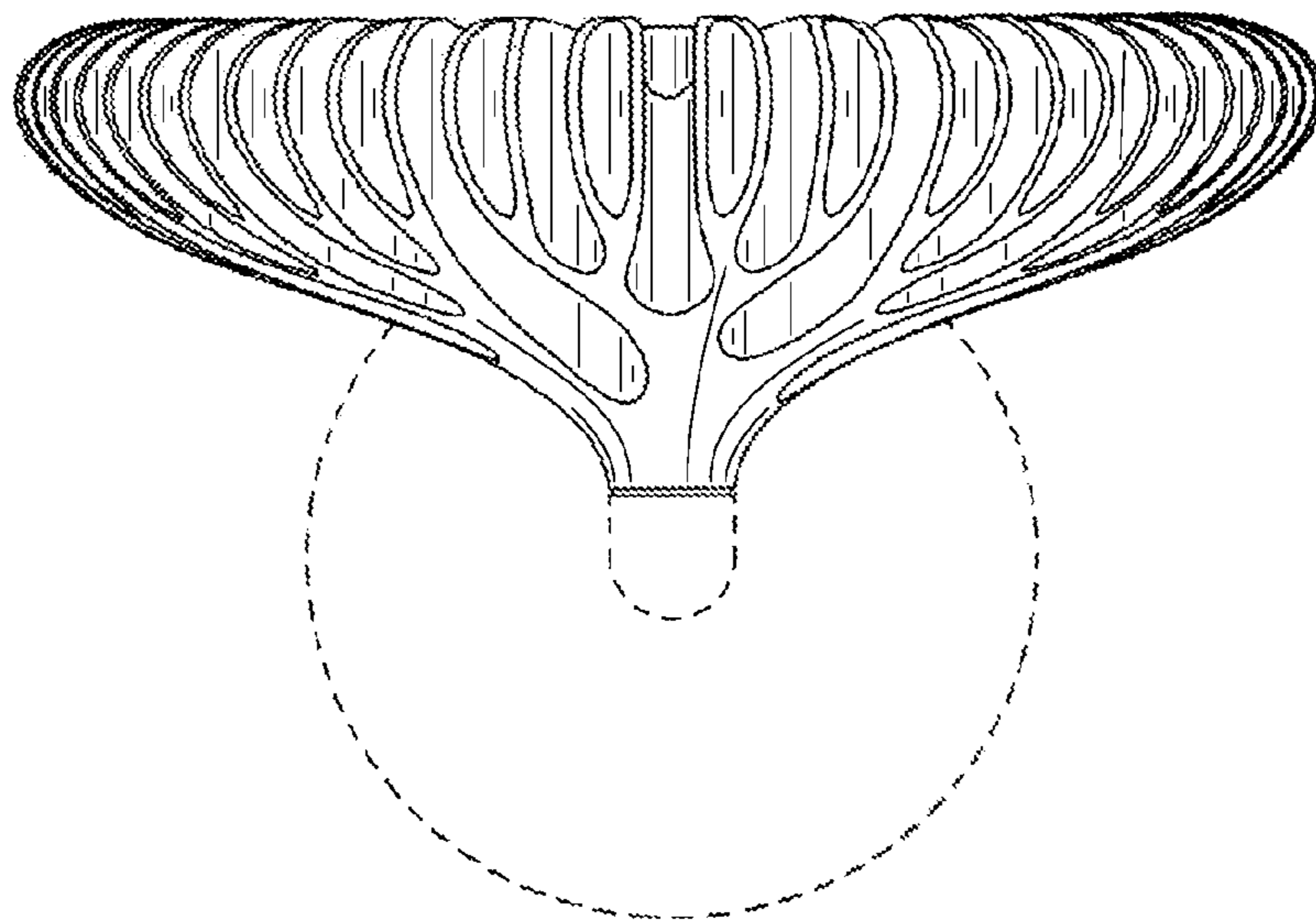

FIG. 2

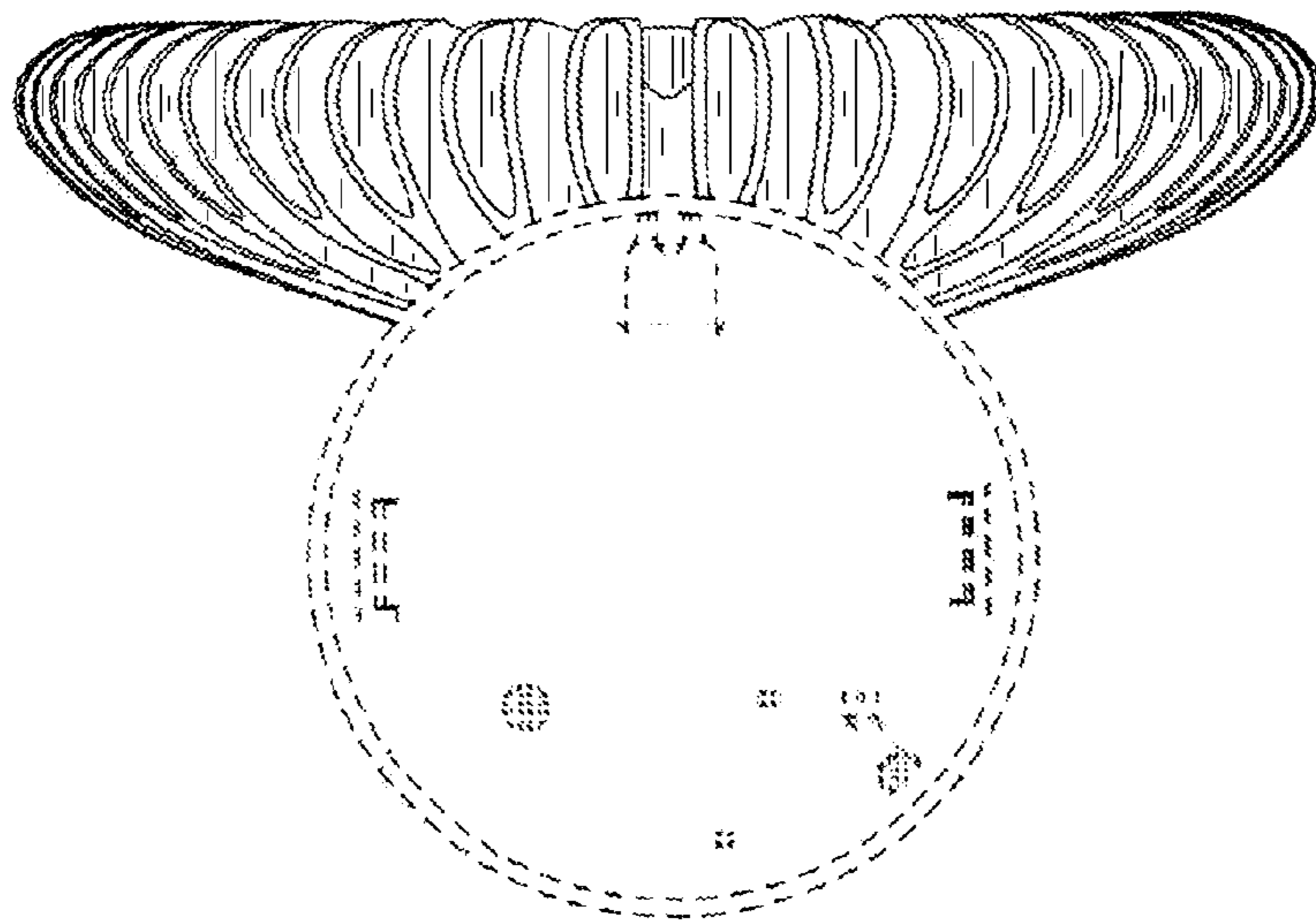

FIG. 3

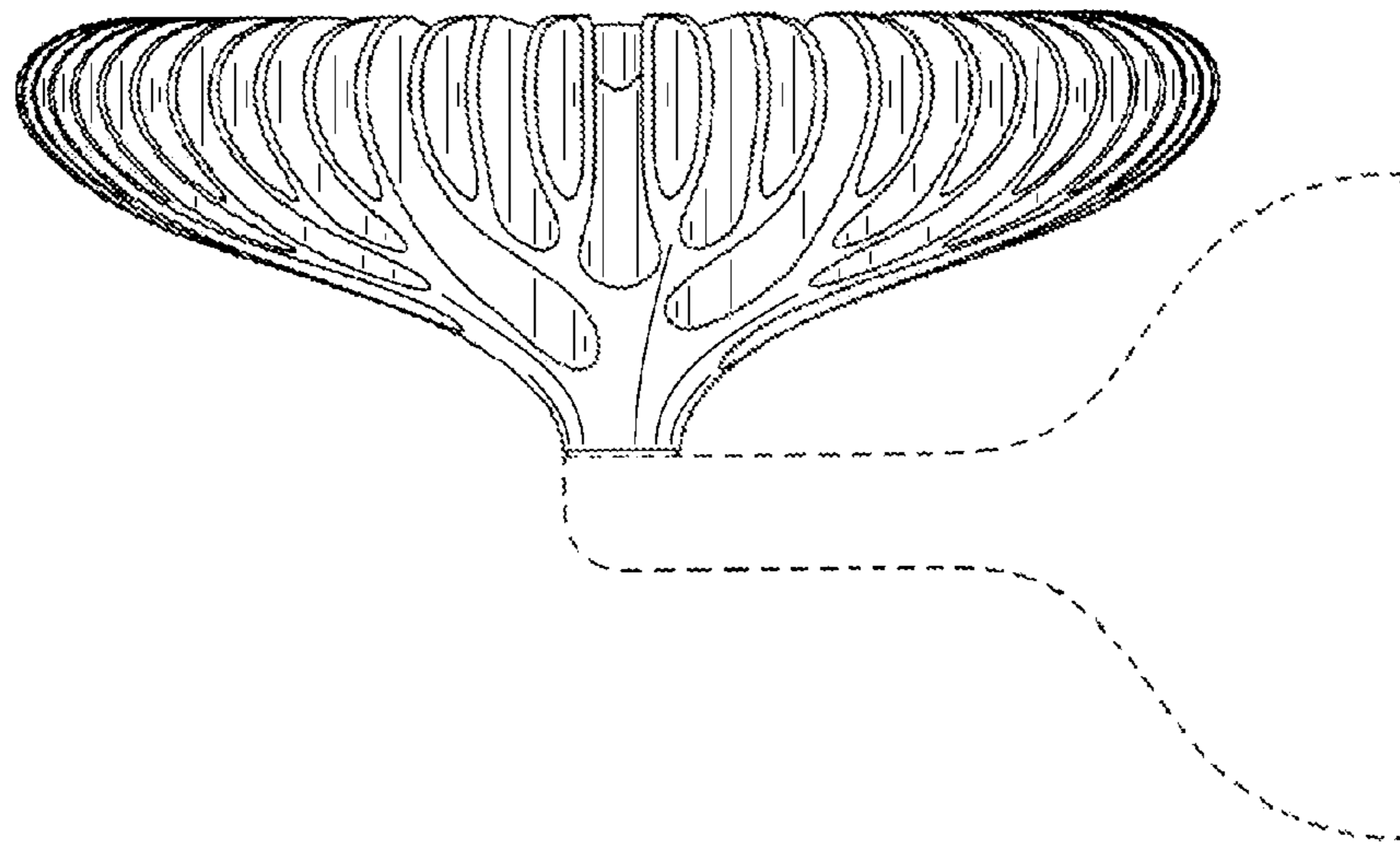

FIG. 4

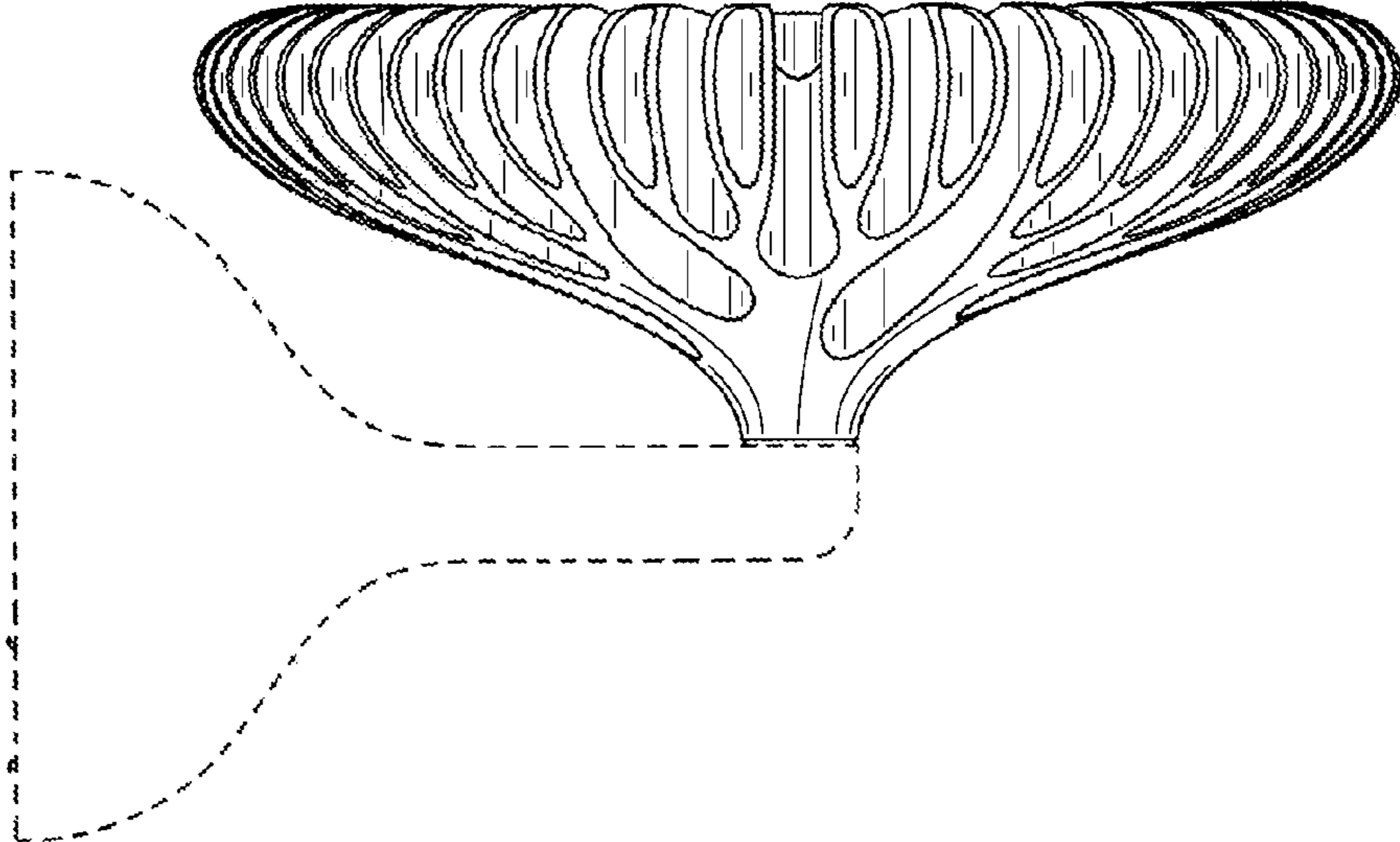

FIG. 5

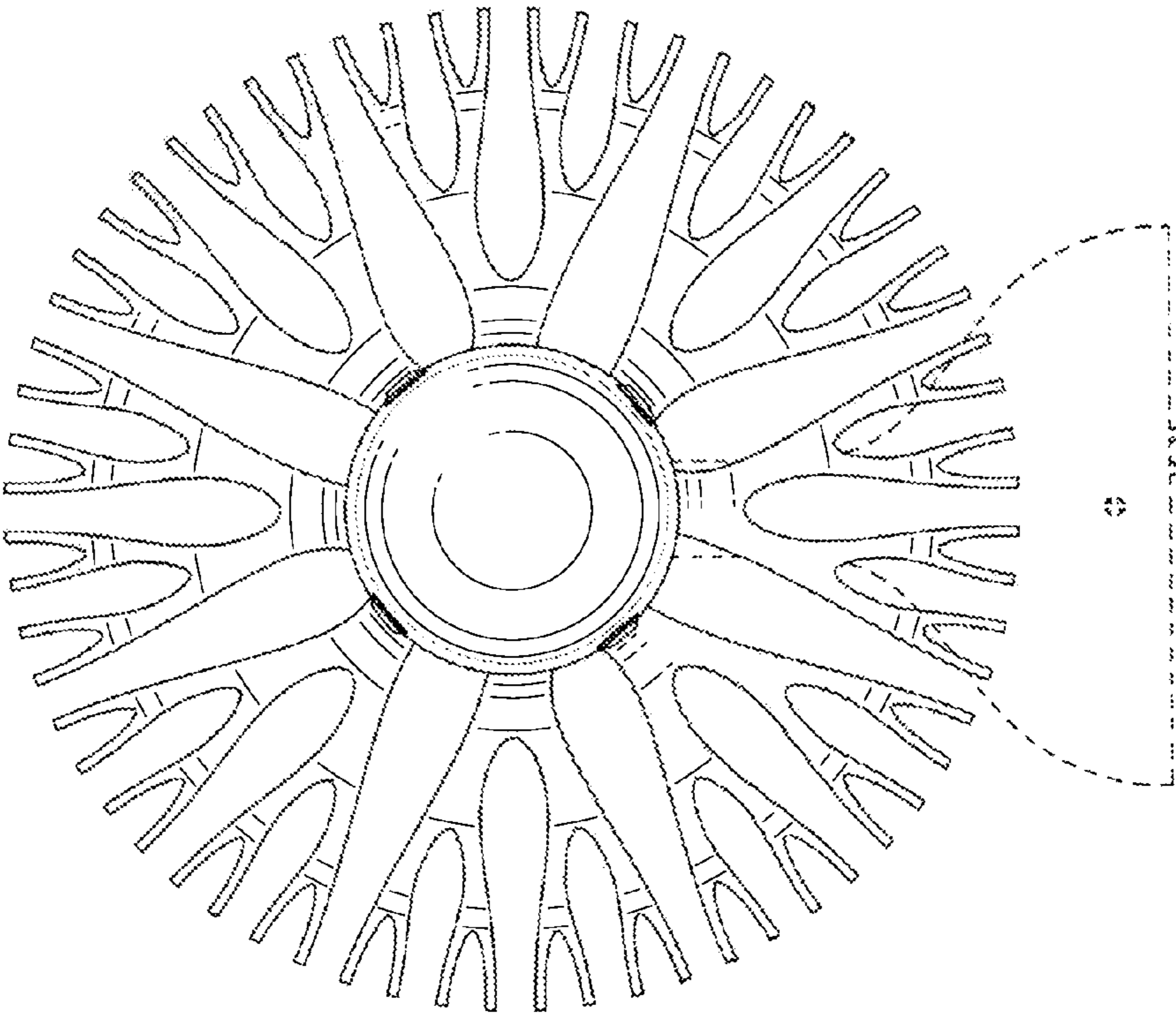

FIG. 6



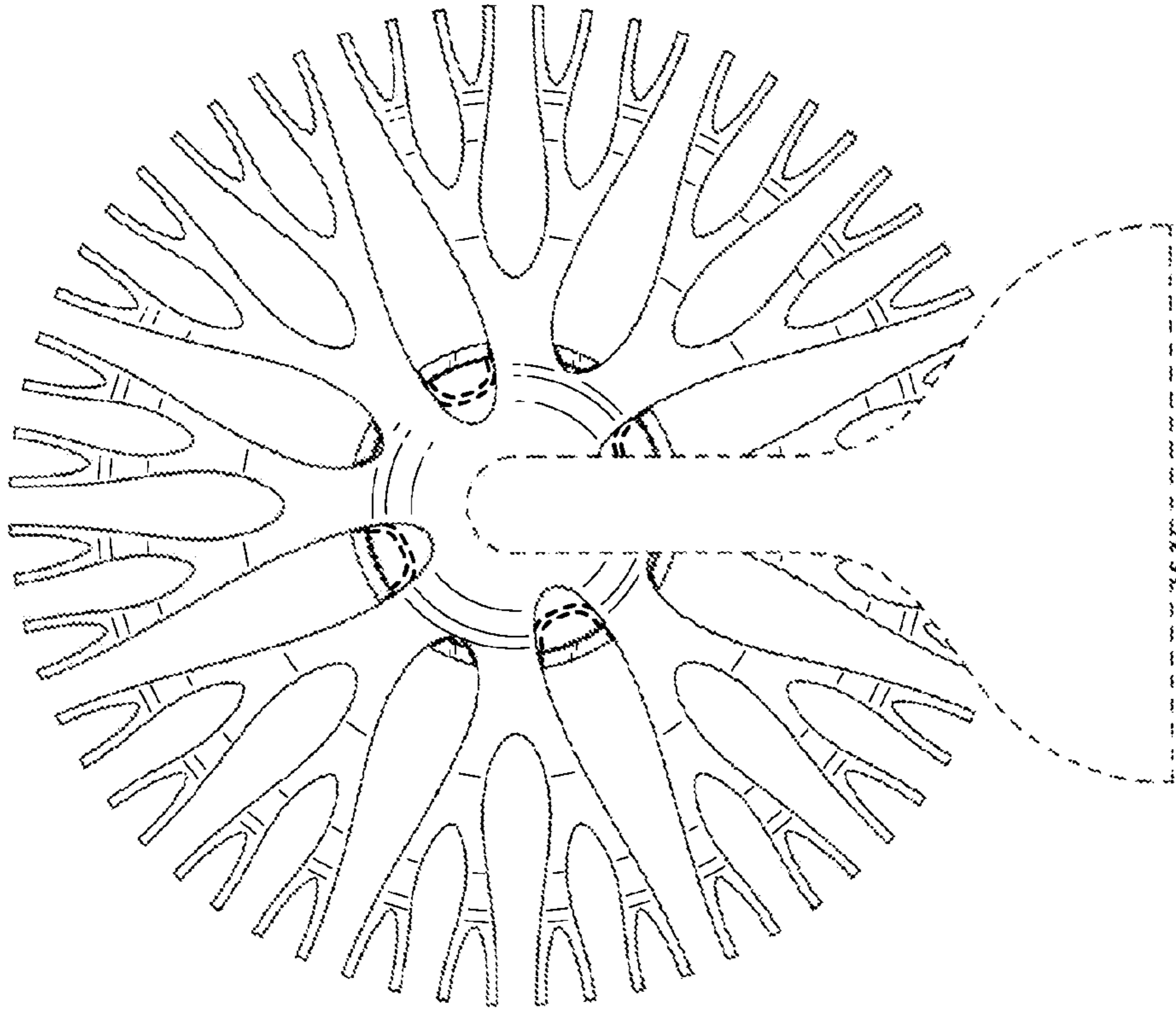

FIG. 7

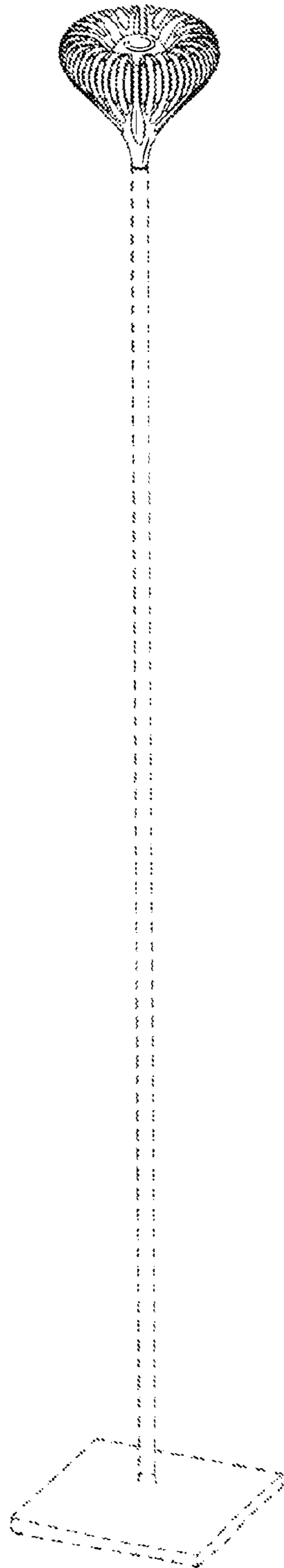

FIG. 8

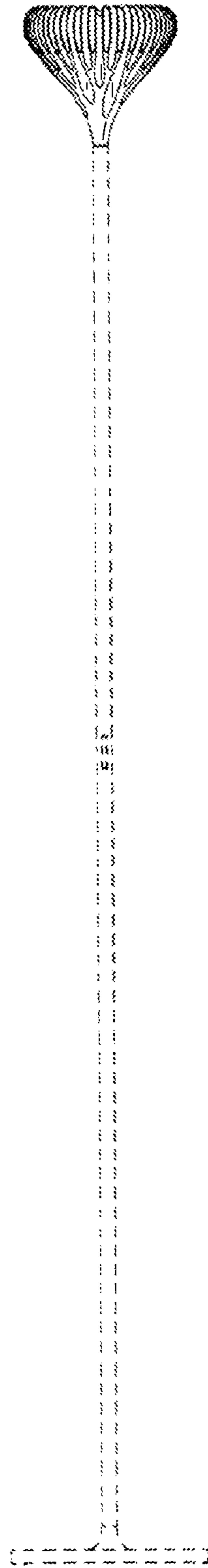

FIG. 9

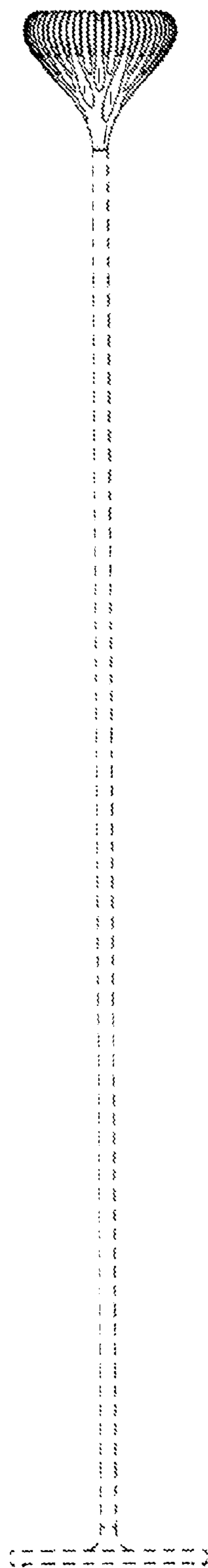

FIG. 10

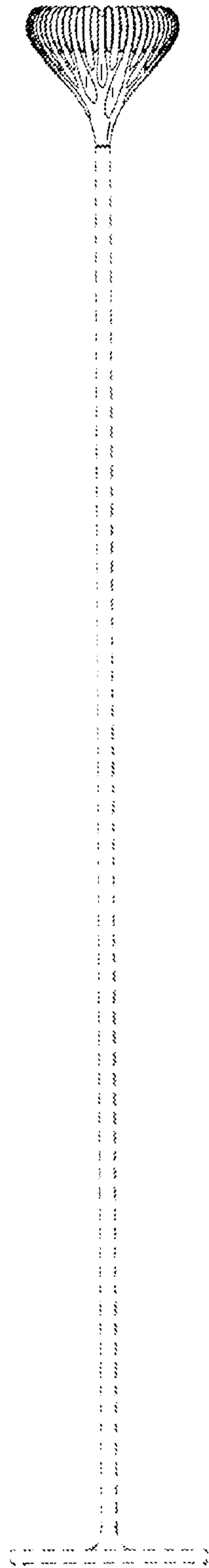

FIG. 11

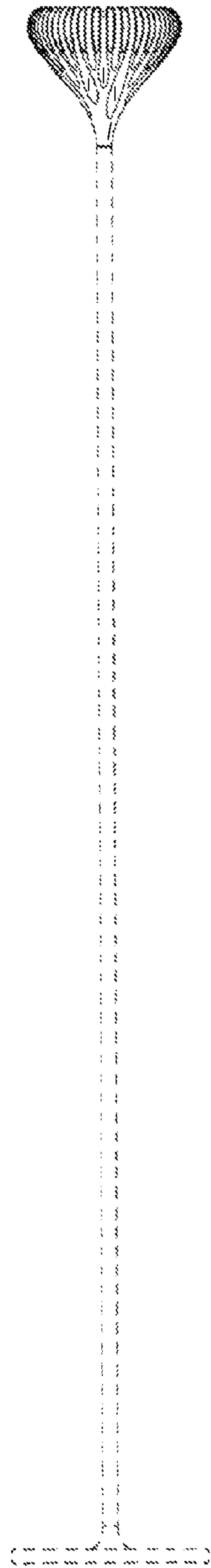

FIG. 12

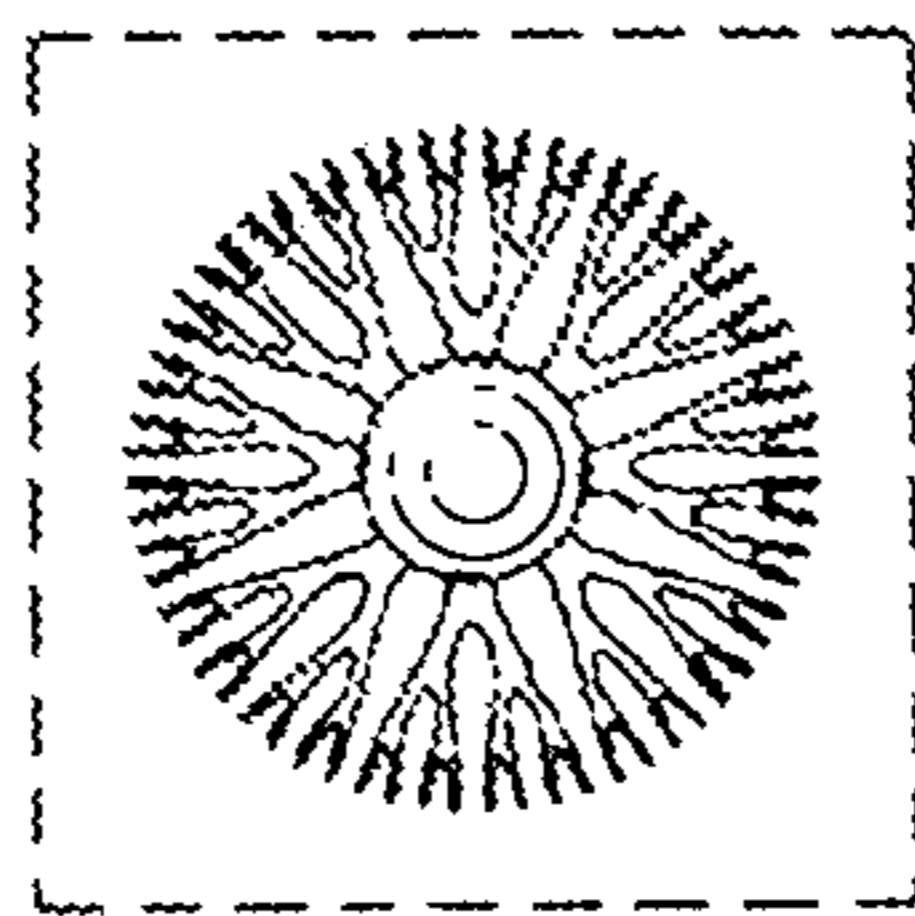

FIG. 13

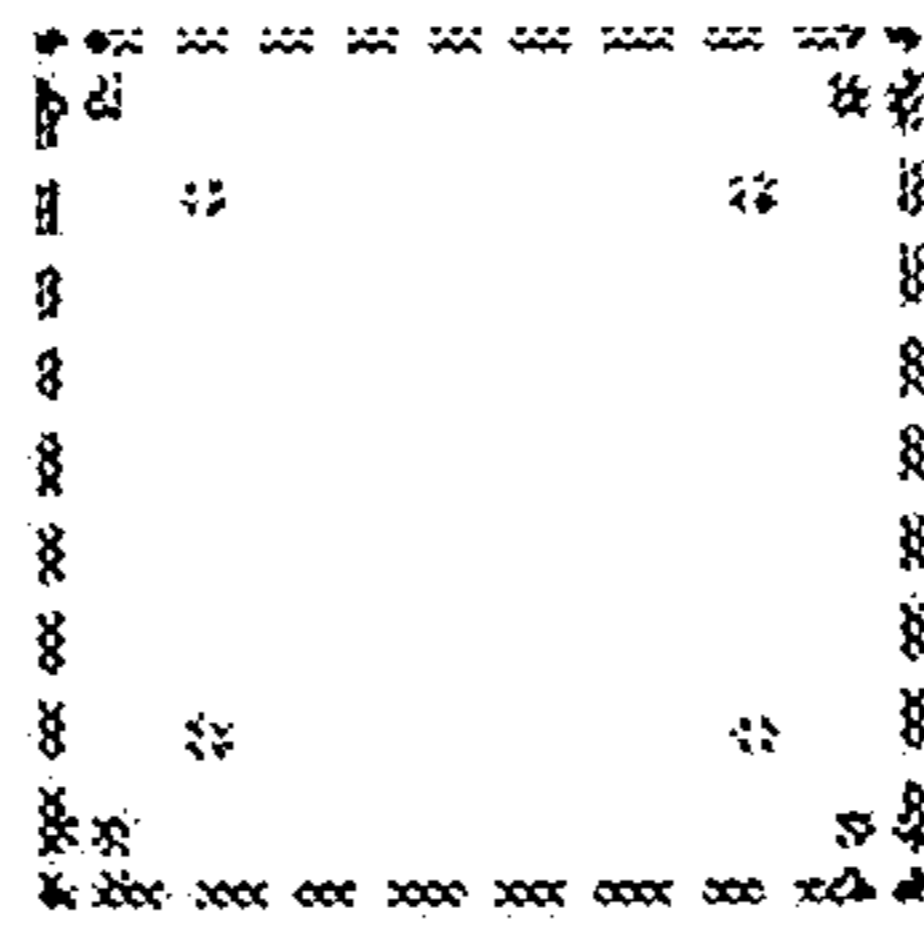

FIG. 14