



US00D734514S

(12) **United States Design Patent**
Greenwell et al.

(10) **Patent No.:** **US D734,514 S**
(45) **Date of Patent:** **** Jul. 14, 2015**

(54) **SCONCE**

(71) Applicant: **Target Brands, Inc.**, Minneapolis, MN (US)
(72) Inventors: **Patrick M. Greenwell**, Woodbury, MN (US); **Sarah E. Wray**, Minneapolis, MN (US)
(73) Assignee: **Target Brands, Inc.**, Minneapolis, MN (US)

(**) Term: **14 Years**

(21) Appl. No.: **29/464,917**

(22) Filed: **Aug. 22, 2013**

(51) **LOC (10) Cl.** **26-01**

(52) **U.S. Cl.**
USPC **D26/19**

(58) **Field of Classification Search**
USPC D26/22, 9, 1, 19, 20, 52, 6, 10, 11, 12, D26/13, 14, 15, 16, 7, 23, 96, 101, 102, D26/116; 431/589, 290–295, 288, 125, 126, 431/366, 369; 392/418, 390, 403–406
See application file for complete search history.

(56) **References Cited**

U.S. PATENT DOCUMENTS

D245,873 S 9/1977 O’Shea
D438,994 S * 3/2001 Chan et al. D26/9

OTHER PUBLICATIONS

Office Action from Canadian Patent Application No. 153,321, mailed Apr. 4, 2014 (2 pages).

Etsy, “Vintage Metal Leaf Candle Sconce-Ranch Cabin,” <http://www.etsy.com/listing/72520599/vintage-metal-leaf-candle-sconce-ranch>, at least as early as Jun. 2013, 1 page.
Etsy, “Handbuilt Hosta Leaf Clay/Pottery Wall Candle Sconces in Blue Celadon,” <http://www.etsy.com/listing/91129194/handbuilt-hosta-leaf-claypottery-wall>, at least as early as Jun. 2013, 1 page.
Open Window Designs, “Garden-Candleholders,” <http://www.openwindowdesigns.com/Products.htm>, at least as early as Jun. 2013, 1 page.

* cited by examiner

Primary Examiner — T. Chase Nelson
Assistant Examiner — Ania Aman

(74) *Attorney, Agent, or Firm* — Leanne Taveggia Farrell; Westman, Champlin & Koehler, P.A.

(57) **CLAIM**

The ornamental design for a sconce, as shown and described.

DESCRIPTION

FIG. 1 is a front perspective view of a sconce showing our new design;
FIG. 2 is a left side elevation view thereof;
FIG. 3 is a right side elevation view thereof;
FIG. 4 is a front elevation view thereof;
FIG. 5 is a back elevation view thereof;
FIG. 6 is a top plan view thereof; and,
FIG. 7 is a bottom plan view thereof.
The broken lines shown in the drawings are included for purposes of illustrating portions of the sconce and form no part of the claimed design.

1 Claim, 6 Drawing Sheets

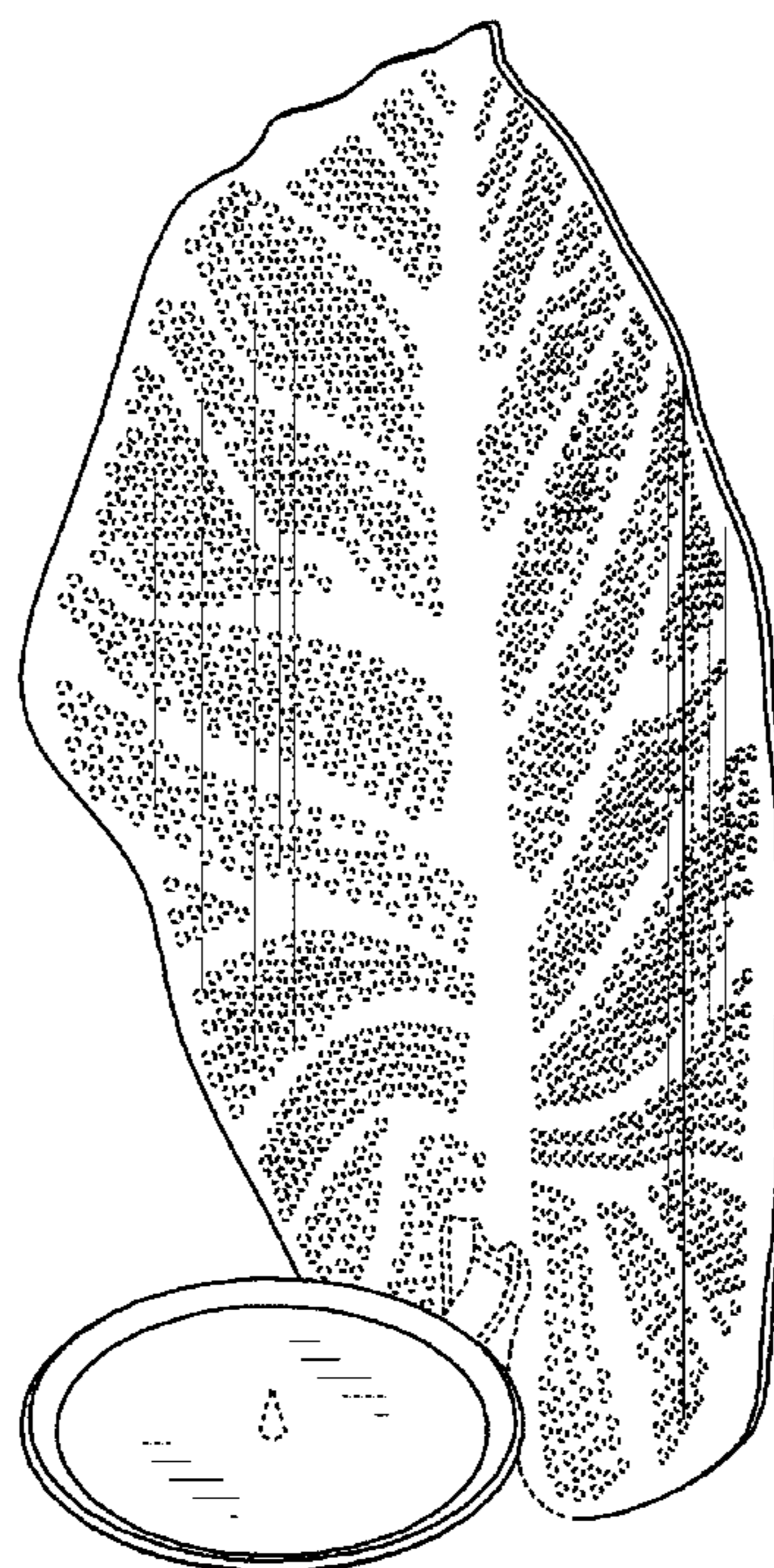

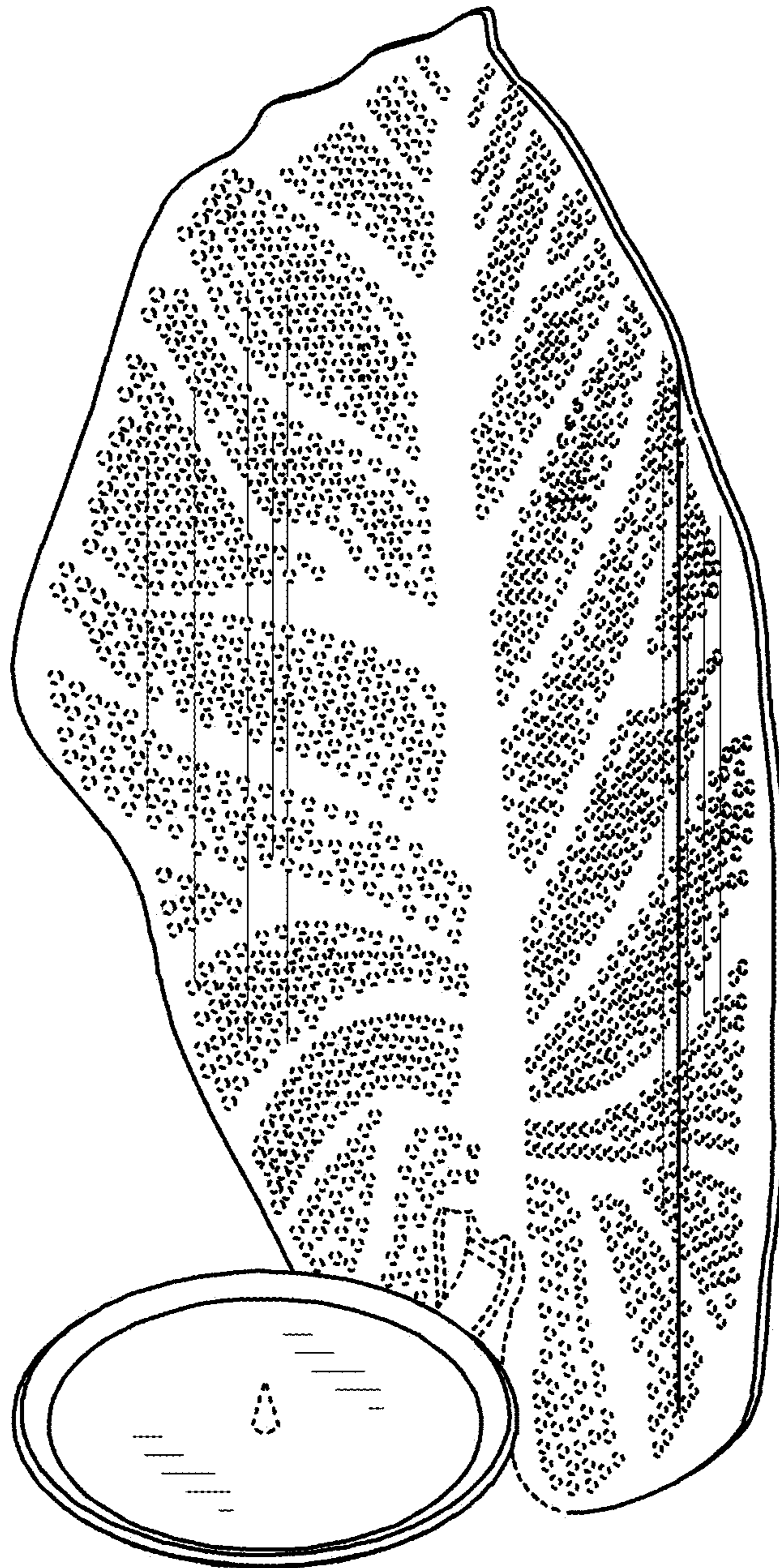

FIG. 1

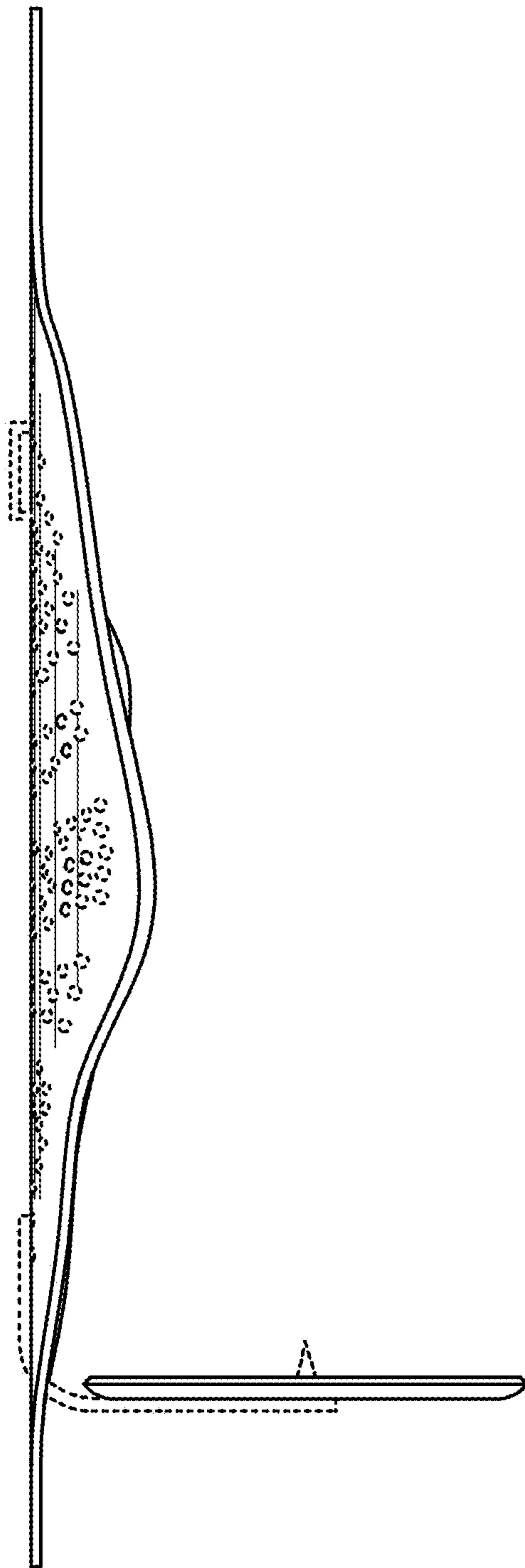

FIG. 2

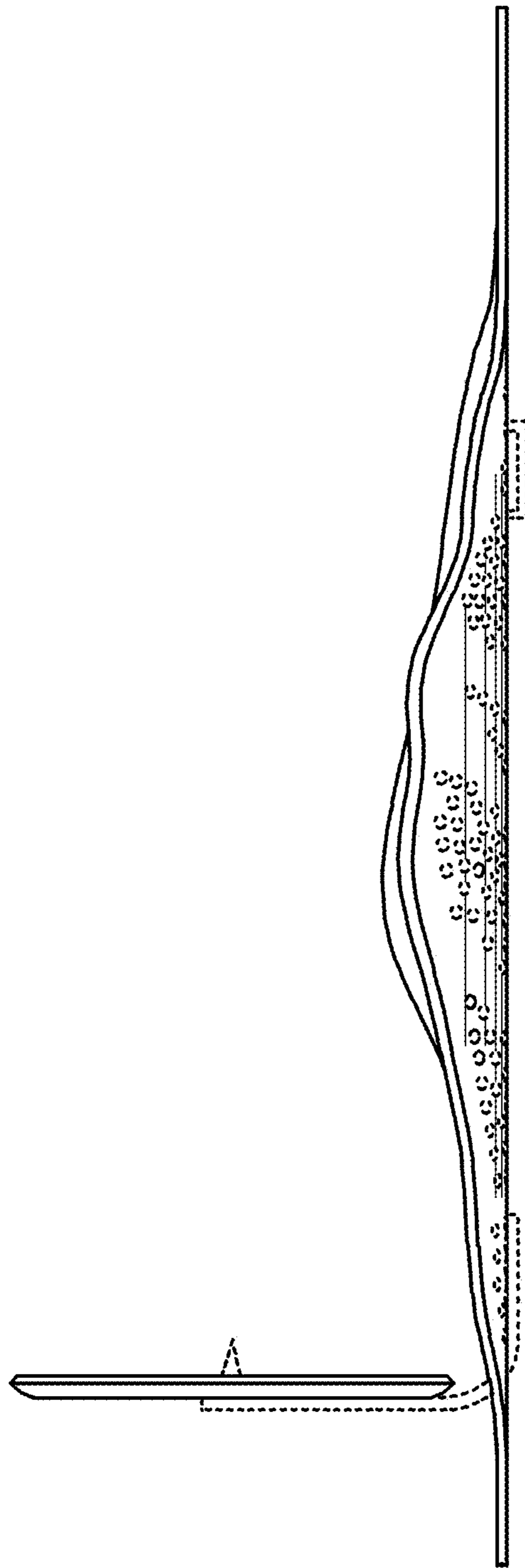

FIG. 3

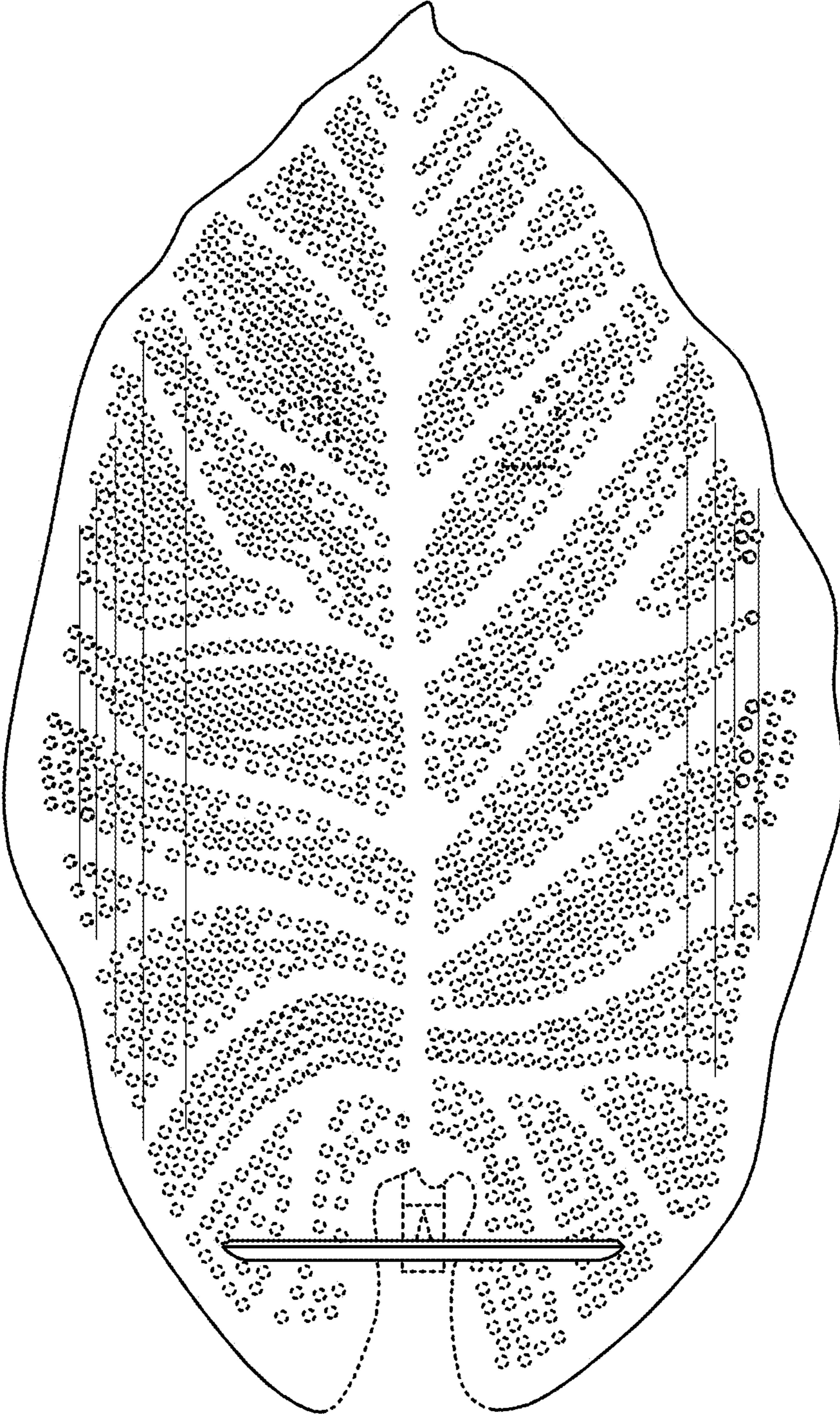

FIG. 4

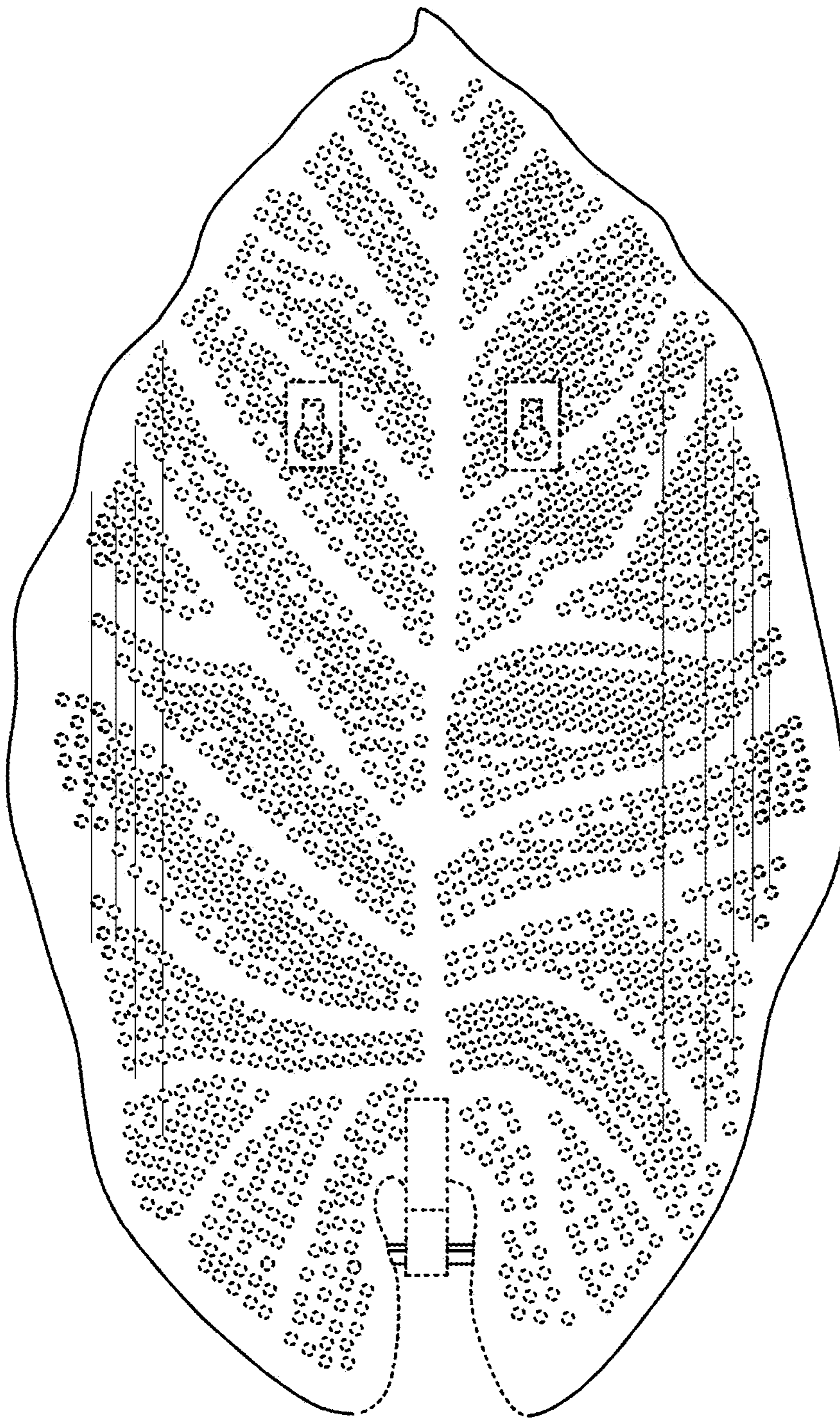

FIG. 5

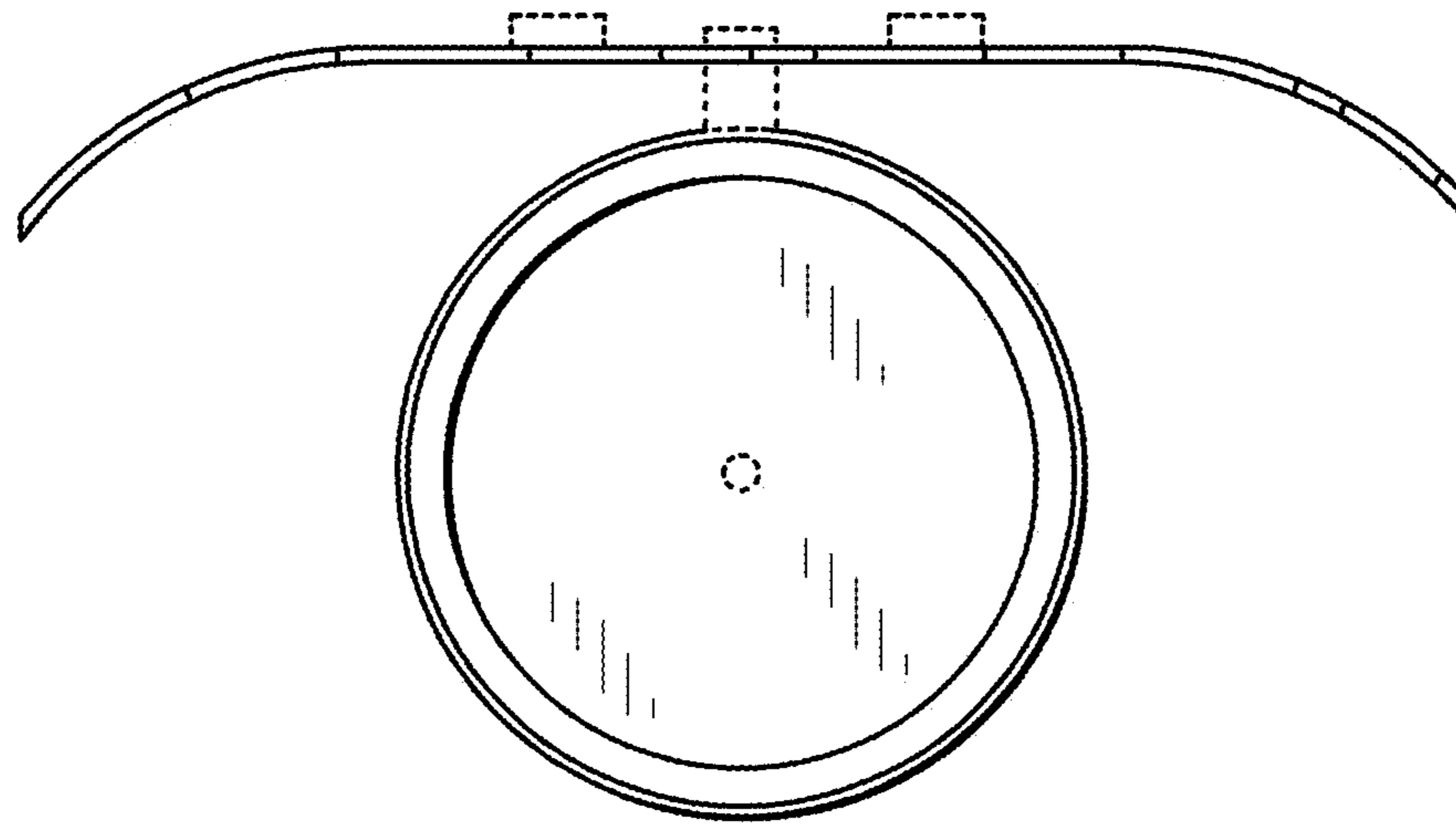

FIG. 6

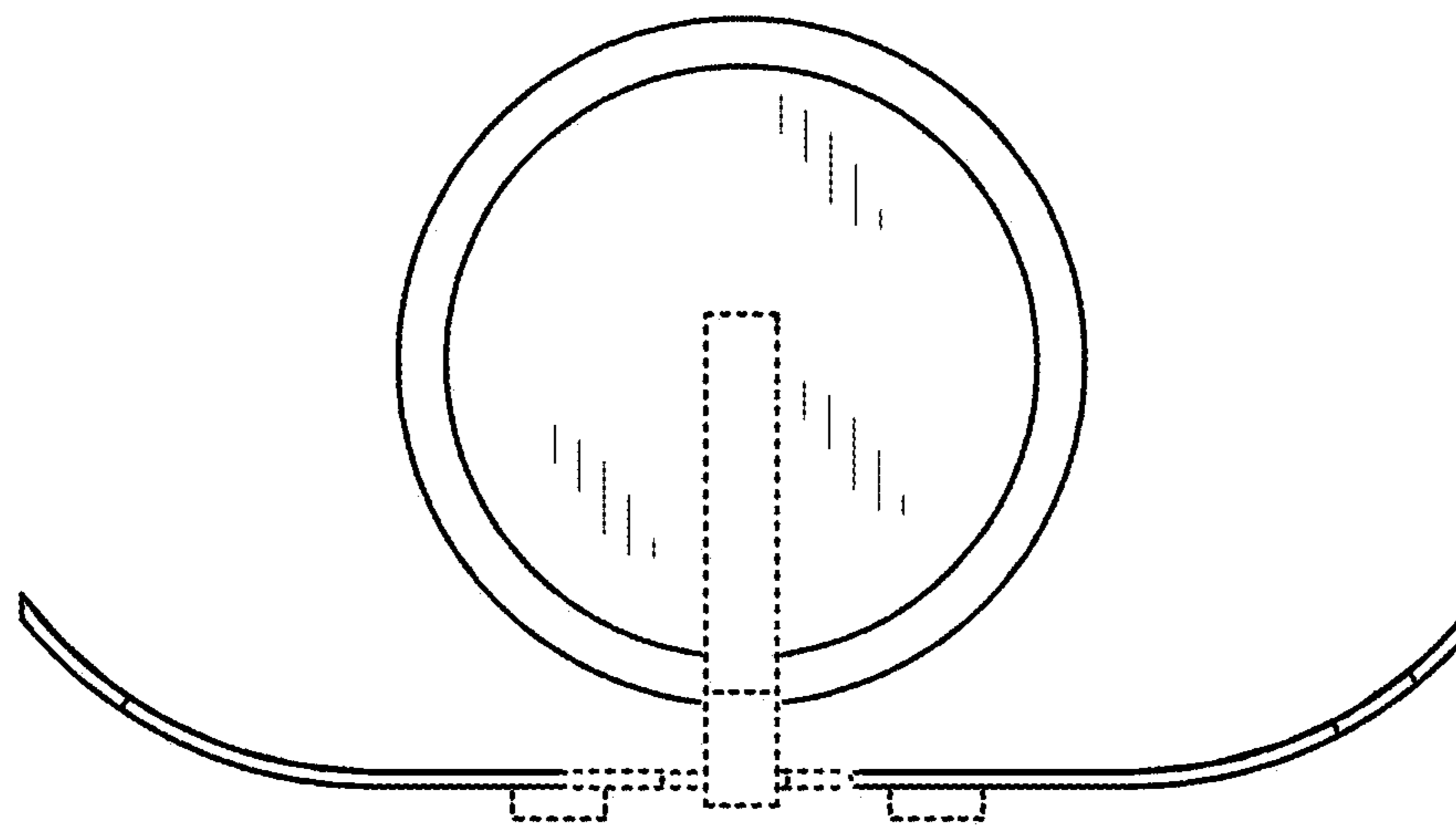

FIG. 7