



US00D734481S

(12) **United States Design Patent**
Sedic

(10) **Patent No.:** **US D734,481 S**
(45) **Date of Patent:** **** Jul. 14, 2015**

(54) **SKIN MASSAGER**

(71) Applicant: **Filip Sedic**, Shanghai (CN)

(72) Inventor: **Filip Sedic**, Shanghai (CN)

(**) Term: **14 Years**

(21) Appl. No.: **29/508,139**

(22) Filed: **Nov. 3, 2014**

Related U.S. Application Data

(63) Continuation of application No. 29/480,166, filed on Jan. 23, 2014, now Pat. No. Des. 716,961, which is a continuation of application No. 29/457,890, filed on Jun. 13, 2013, now Pat. No. Des. 698,455.

Foreign Application Priority Data

(30) Jan. 17, 2013 (CN) 2013 3 0013432
Jan. 17, 2013 (CN) 2013 3 0013435

(51) **LOC (10) Cl.** **28-03**

(52) **U.S. Cl.**
USPC **D24/215**

(58) **Field of Classification Search**
USPC D24/200, 211, 212, 213, 214, 215;
601/114, 120, 121, 124, 125, 130, 131,
601/134, 135, 136, 137
CPC A61H 19/30; A61H 19/32; A61H 19/34;
A61H 19/40; A61H 19/44; A61H 19/50;
A61H 19/00; A61H 2201/0153; A61H
2201/0207; A61H 2201/0263; A61H
2201/0111; A61H 2201/1253; A61H
2205/082; A61H 2205/085; A61H 15/0085
See application file for complete search history.

(56) **References Cited**

U.S. PATENT DOCUMENTS

D351,474 S * 10/1994 Huang D24/211
D369,220 S * 4/1996 Huang D24/215
D466,217 S * 11/2002 Harris et al. D24/215
D487,592 S * 3/2004 Chang D24/215

D517,218 S * 3/2006 Kalen D24/215
D539,917 S * 4/2007 Park D24/215
D548,851 S * 8/2007 Huang D24/214
D571,926 S * 6/2008 Wu D24/215
D626,656 S * 11/2010 Jarry D24/215
D645,569 S * 9/2011 Nitsch D24/215
D674,108 S * 1/2013 York D24/215
D698,455 S * 1/2014 Sedic D24/215

* cited by examiner

Primary Examiner — Sandra Snapp

(74) *Attorney, Agent, or Firm* — Fenwick & West LLP

(57) **CLAIM**

I claim the ornamental design for a skin massager, as shown and described.

DESCRIPTION

FIG. 1 is a front view of a first embodiment of a skin massager. FIG. 2 is a right side view of the first embodiment of the skin massager. FIG. 3 is a rear view of the first embodiment of the skin massager. FIG. 4 is a left side view of the first embodiment of the skin massager. FIG. 5 is a top view of the first embodiment of the skin massager. FIG. 6 is a bottom view of the first embodiment of the skin massager. FIGS. 7 and 8 are perspective views of the first embodiment of the skin massager. FIG. 9 is a front view of a second embodiment of the skin massager. FIG. 10 is a right side view of the second embodiment of the skin massager. FIG. 11 is a rear view of the second embodiment of the skin massager. FIG. 12 is a left side view of the second embodiment of the skin massager. FIG. 13 is a top view of the second embodiment of the skin massager. FIG. 14 is a bottom view of the second embodiment of the skin massager.

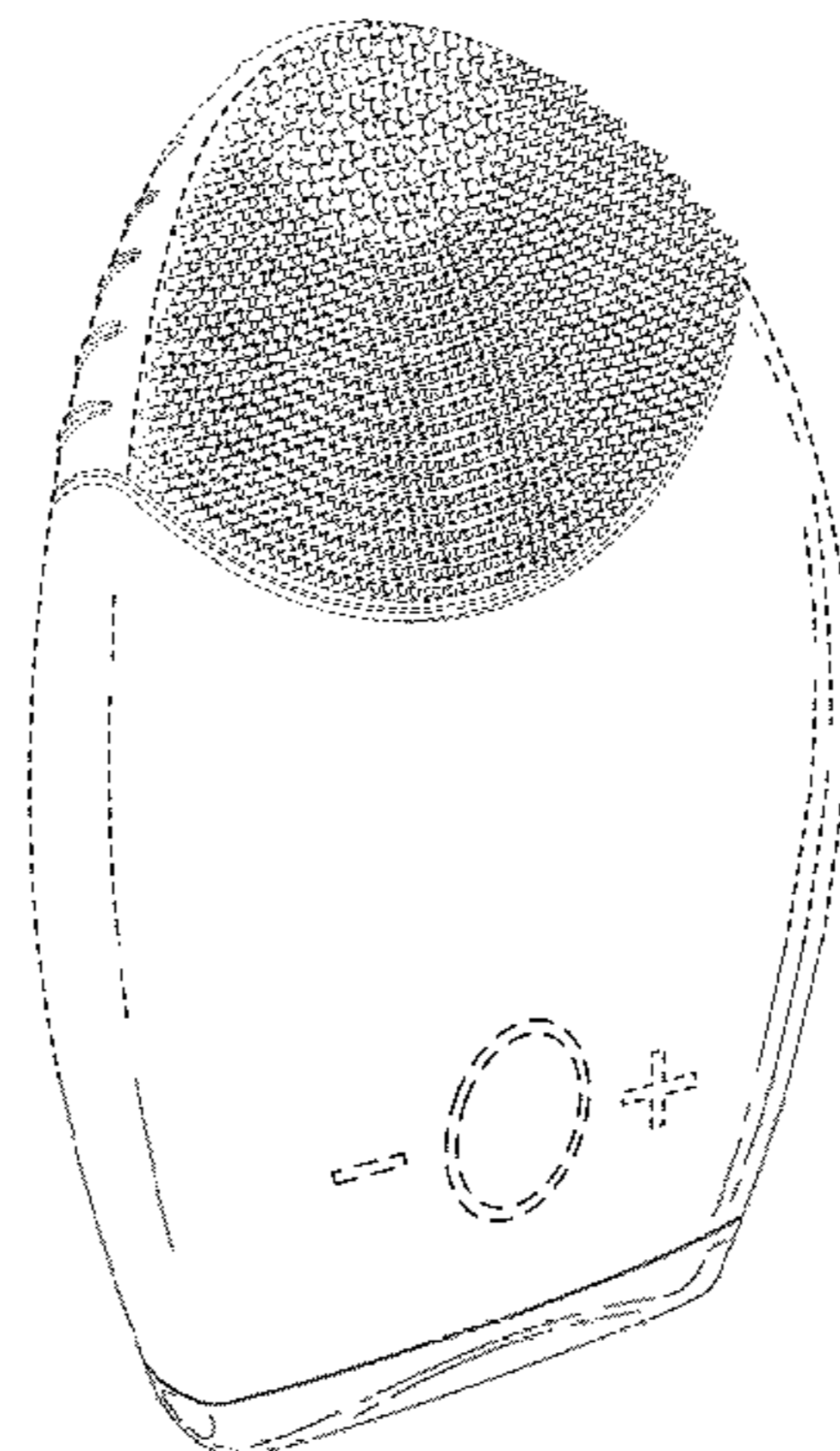

FIGS. 15 and 16 are perspective views of the embodiment of the second skin massager.

FIG. 17 is a front view of a third embodiment of the skin massager.

FIG. 18 is a right side view of the third embodiment of the skin massager.

FIG. 19 is a rear view of the third embodiment of the skin massager.

FIG. 20 is a left side view of the third embodiment of the skin massager.

FIG. 21 is a top view of the third embodiment of the skin massager.

FIG. 22 is a bottom view of the third embodiment of the skin massager.

FIGS. 23 and 24 are perspective views of the third embodiment of the skin massager.

FIG. 25 is a front view of a fourth embodiment of the skin massager.

FIG. 26 is a right side view of the fourth embodiment of the skin massager.

FIG. 27 is a rear view of the fourth embodiment of the skin massager.

FIG. 28 is a left side view of the fourth embodiment of the skin massager.

FIG. 29 is a top view of the fourth embodiment of the skin massager.

FIG. 30 is a bottom view of the fourth embodiment of the skin massager.

FIGS. 31 and 32 are perspective views of the fourth embodiment of the skin massager.

FIG. 33 is a front view of a fifth embodiment of the skin massager.

FIG. 34 is a right side view of the fifth embodiment of the skin massager.

FIG. 35 is a rear view of the fifth embodiment of the skin massager.

FIG. 36 is a left side view of the fifth embodiment of the skin massager.

FIG. 37 is a top view of the fifth embodiment of the skin massager.

FIG. 38 is a bottom view of the fifth embodiment of the skin massager.

FIGS. 39 and 40 are perspective views of the fifth embodiment of the skin massager.

FIG. 41 is a front view of a sixth embodiment of a skin massager.

FIG. 42 is a right side view of the sixth embodiment of the skin massager.

FIG. 43 is a rear view of the sixth embodiment of the skin massager.

FIG. 44 is a left side view of the sixth embodiment of the skin massager.

FIG. 45 is a top view of the sixth embodiment of the skin massager.

FIG. 46 is a bottom view of the sixth embodiment of the skin massager.

FIGS. 47 and 48 are perspective views of the sixth embodiment of the skin massager.

FIG. 49 is a front view of a seventh embodiment of the skin massager.

FIG. 50 is a right side view of the seventh embodiment of the skin massager.

FIG. 51 is a rear view of the seventh embodiment of the skin massager.

FIG. 52 is a left side view of the seventh embodiment of the skin massager.

FIG. 53 is a top view of the seventh embodiment of the skin massager.

FIG. 54 is a bottom view of the seventh embodiment of the skin massager.

FIGS. 55 and 56 are perspective views of the embodiment of the seventh skin massager.

FIG. 57 is a front view of a eighth embodiment of the skin massager.

FIG. 58 is a right side view of the eighth embodiment of the skin massager.

FIG. 59 is a rear view of the eighth embodiment of the skin massager.

FIG. 60 is a left side view of the eighth embodiment of the skin massager.

FIG. 61 is a top view of the eighth embodiment of the skin massager.

FIG. 62 is a bottom view of the eighth embodiment of the skin massager.

FIGS. 63 and 64 are perspective views of the eighth embodiment of the skin massager.

FIG. 65 is a front view of a ninth embodiment of the skin massager.

FIG. 66 is a right side view of the ninth embodiment of the skin massager.

FIG. 67 is a rear view of the ninth embodiment of the skin massager.

FIG. 68 is a left side view of the ninth embodiment of the skin massager.

FIG. 69 is a top view of the ninth embodiment of the skin massager.

FIG. 70 is a bottom view of the ninth embodiment of the skin massager.

FIGS. 71 and 72 are perspective views of the ninth embodiment of the skin massager.

FIG. 73 is a front view of a tenth embodiment of the skin massager.

FIG. 74 is a right side view of the tenth embodiment of the skin massager.

FIG. 75 is a rear view of the tenth embodiment of the skin massager.

FIG. 76 is a left side view of the tenth embodiment of the skin massager.

FIG. 77 is a top view of the tenth embodiment of the skin massager.

FIG. 78 is a bottom view of the tenth embodiment of the skin massager; and,

FIGS. 79 and 80 are perspective views of the tenth embodiment of the skin massager.

The broken lines are directed to environment and are for illustrative purposes only; the broken lines form no part of the claimed design.

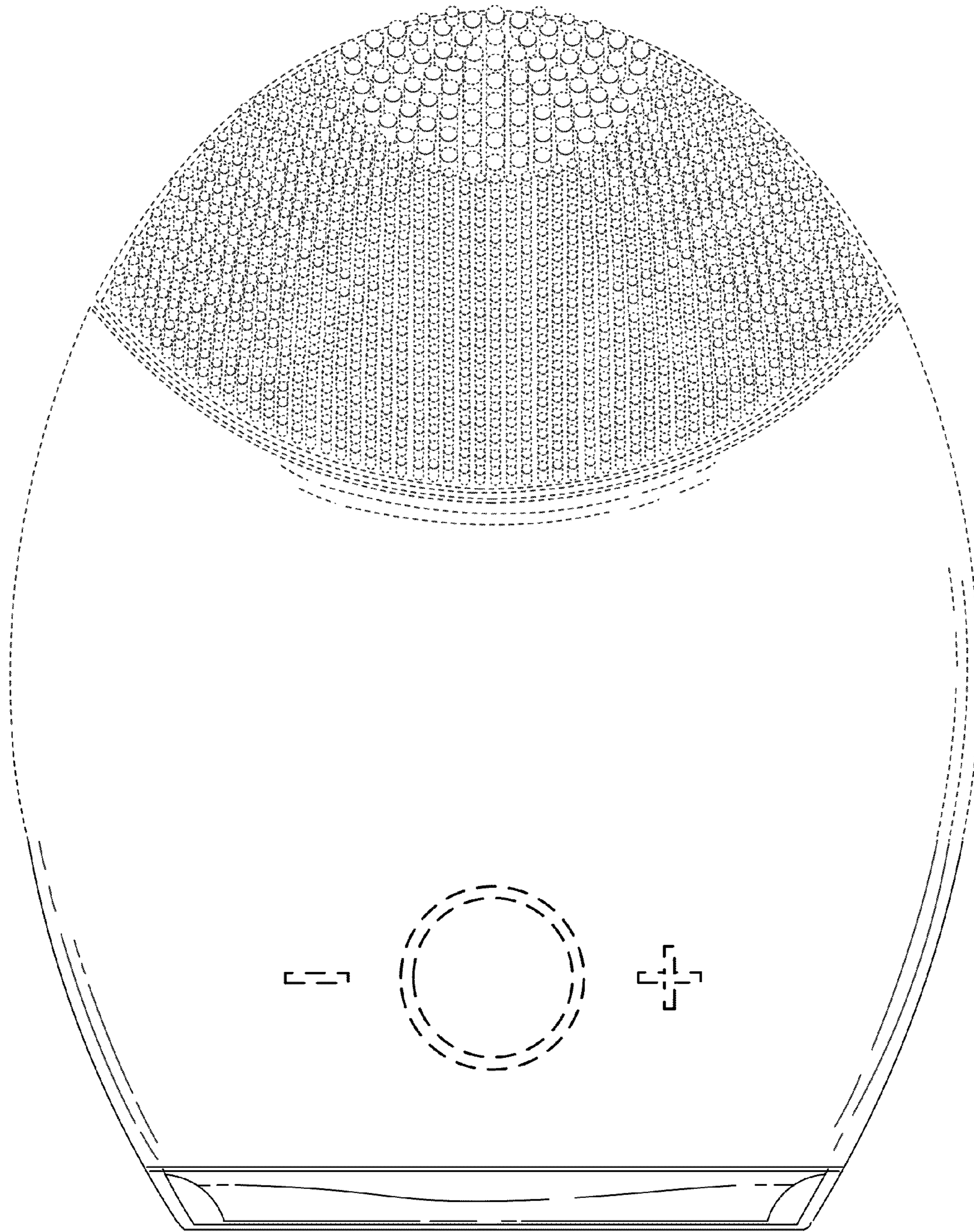

FIG. 1

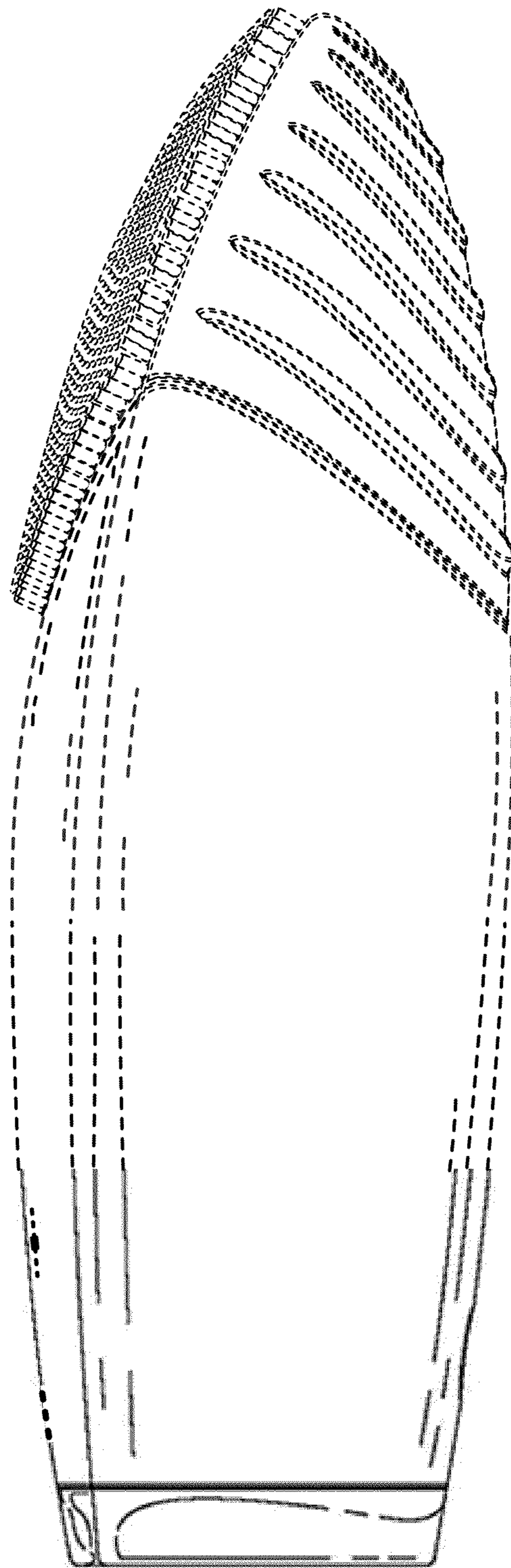

FIG. 2

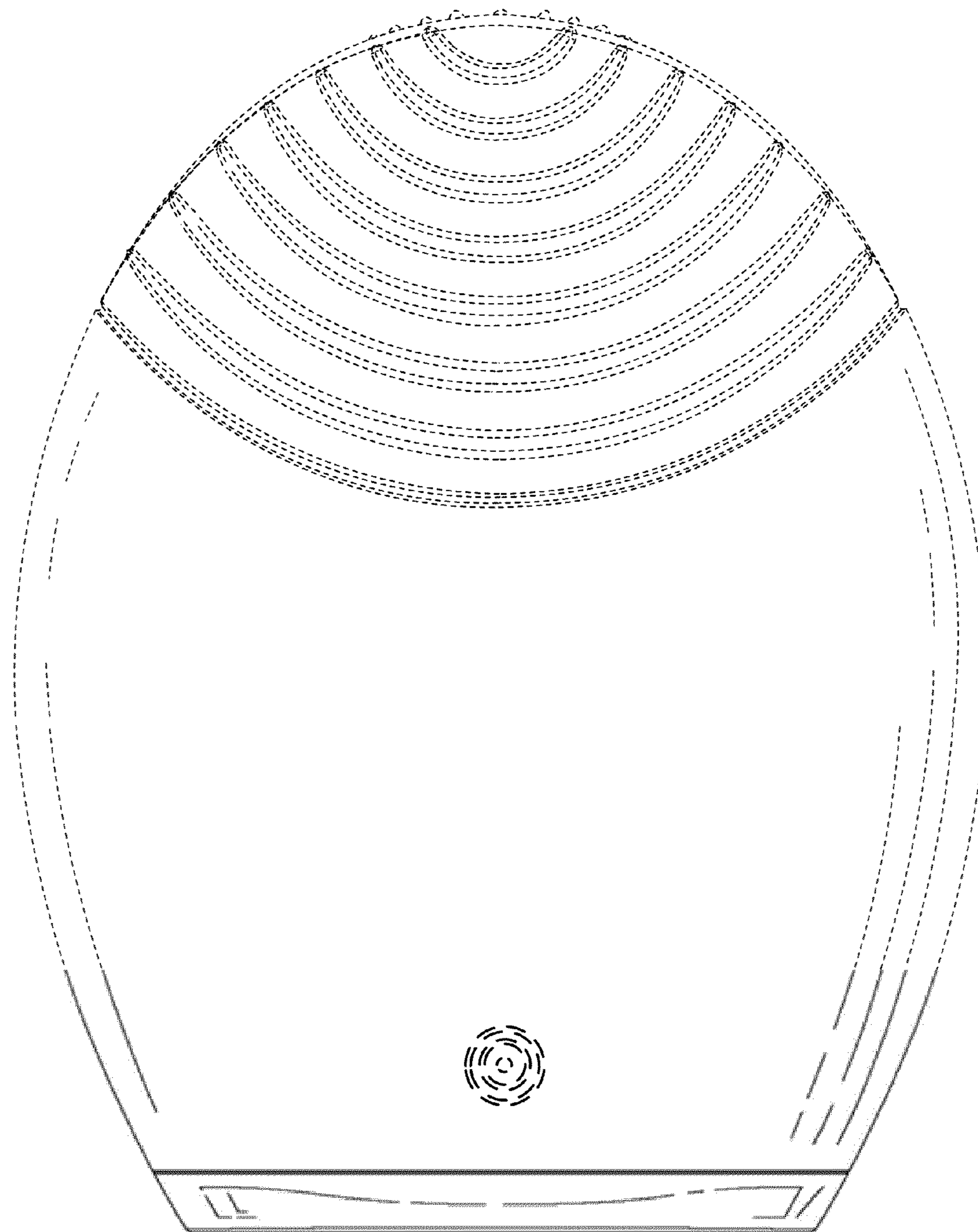

FIG. 3

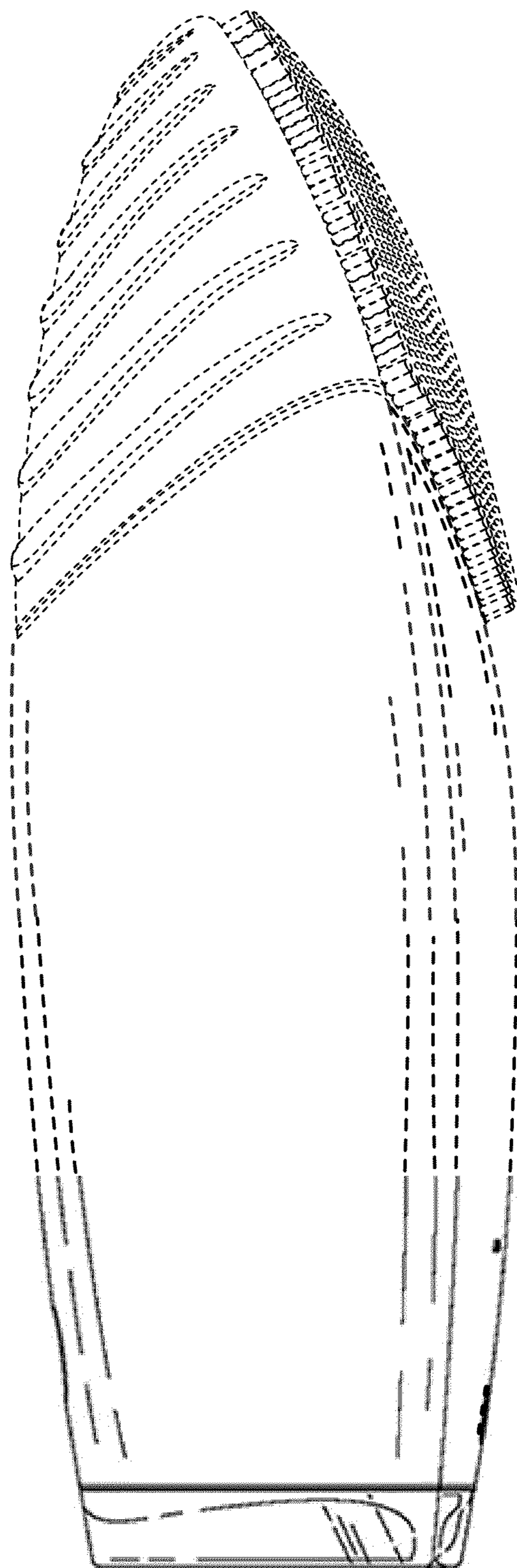

FIG. 4

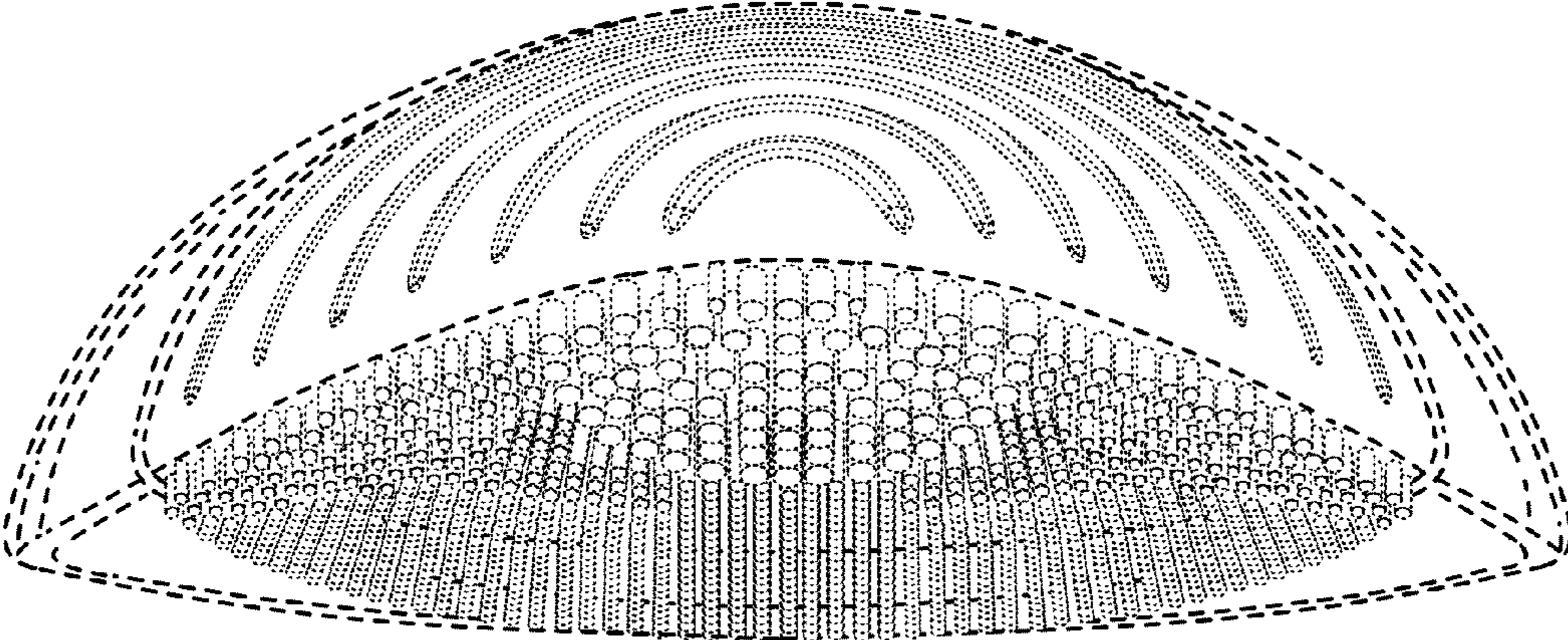

FIG. 5

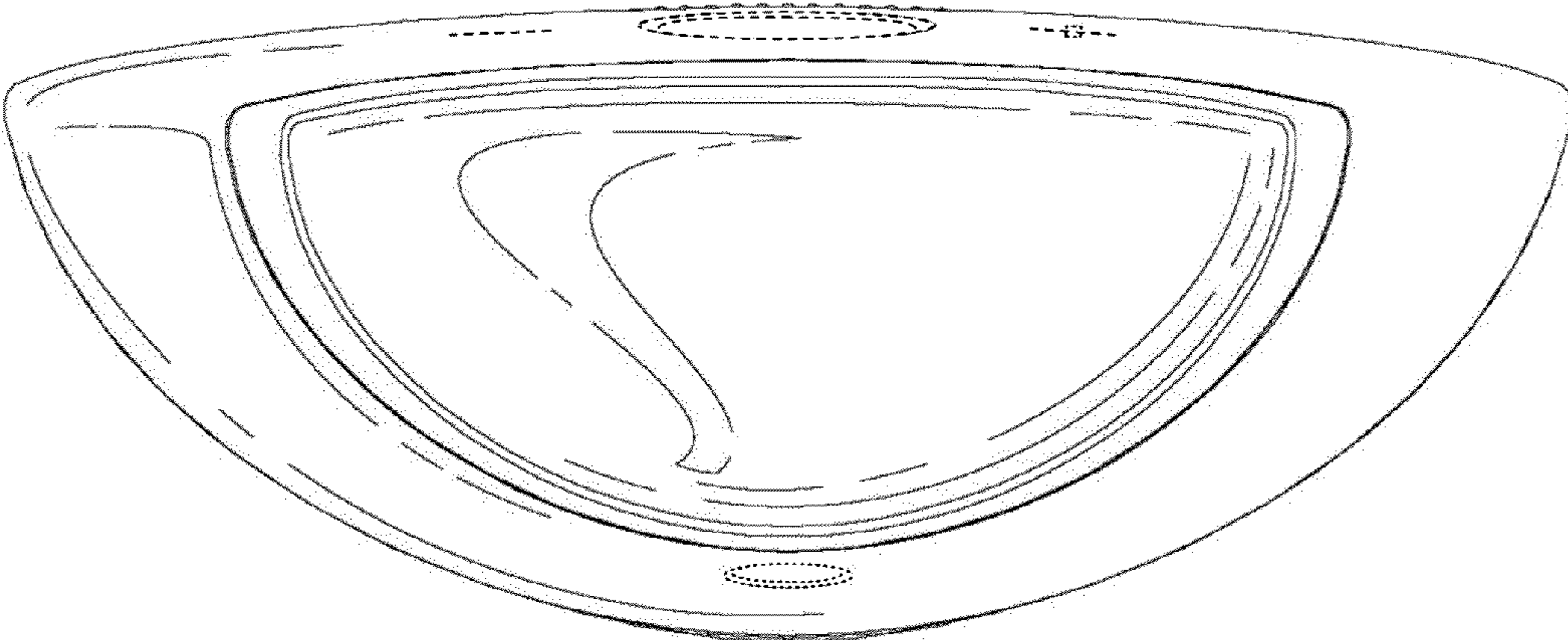

FIG. 6

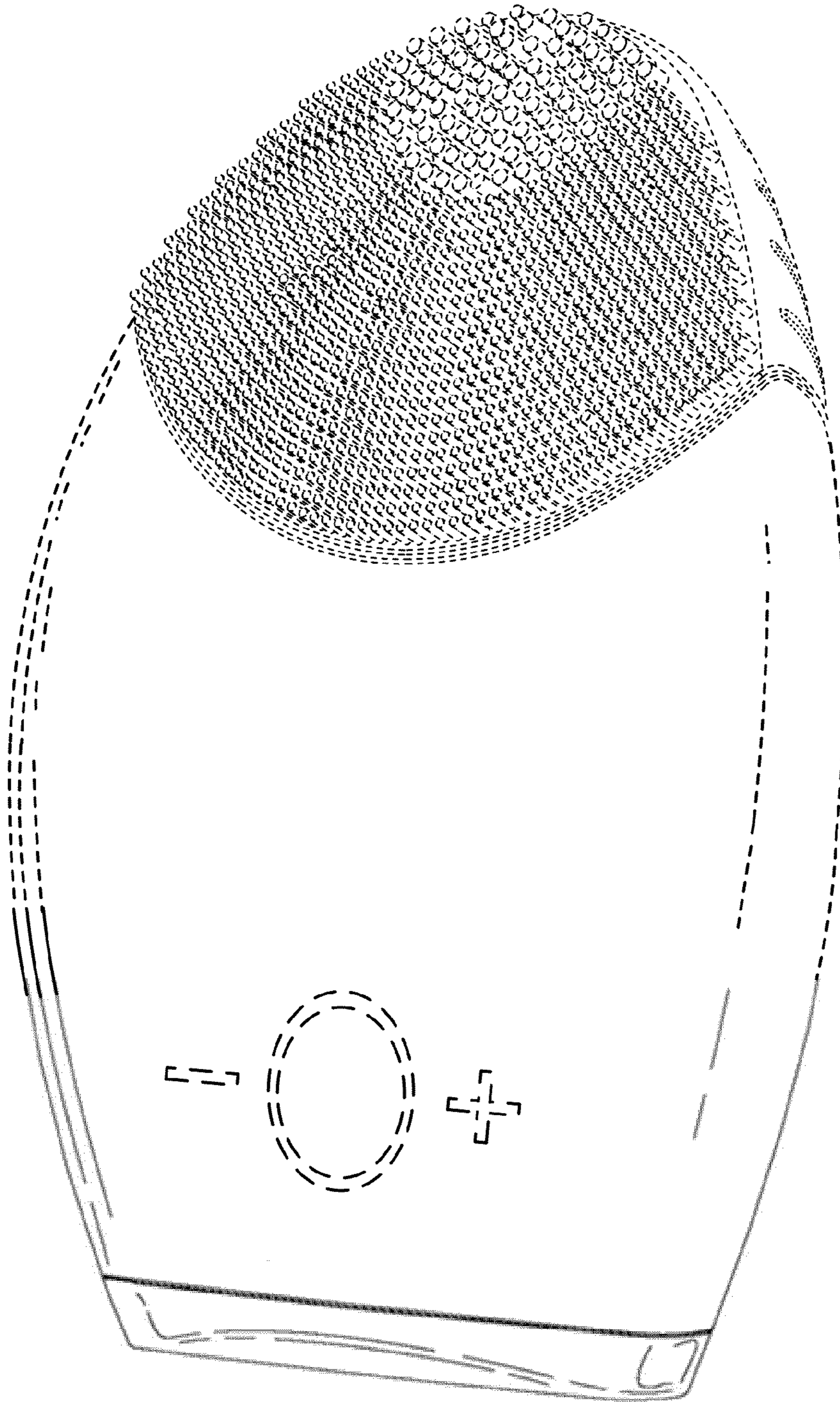

FIG. 7

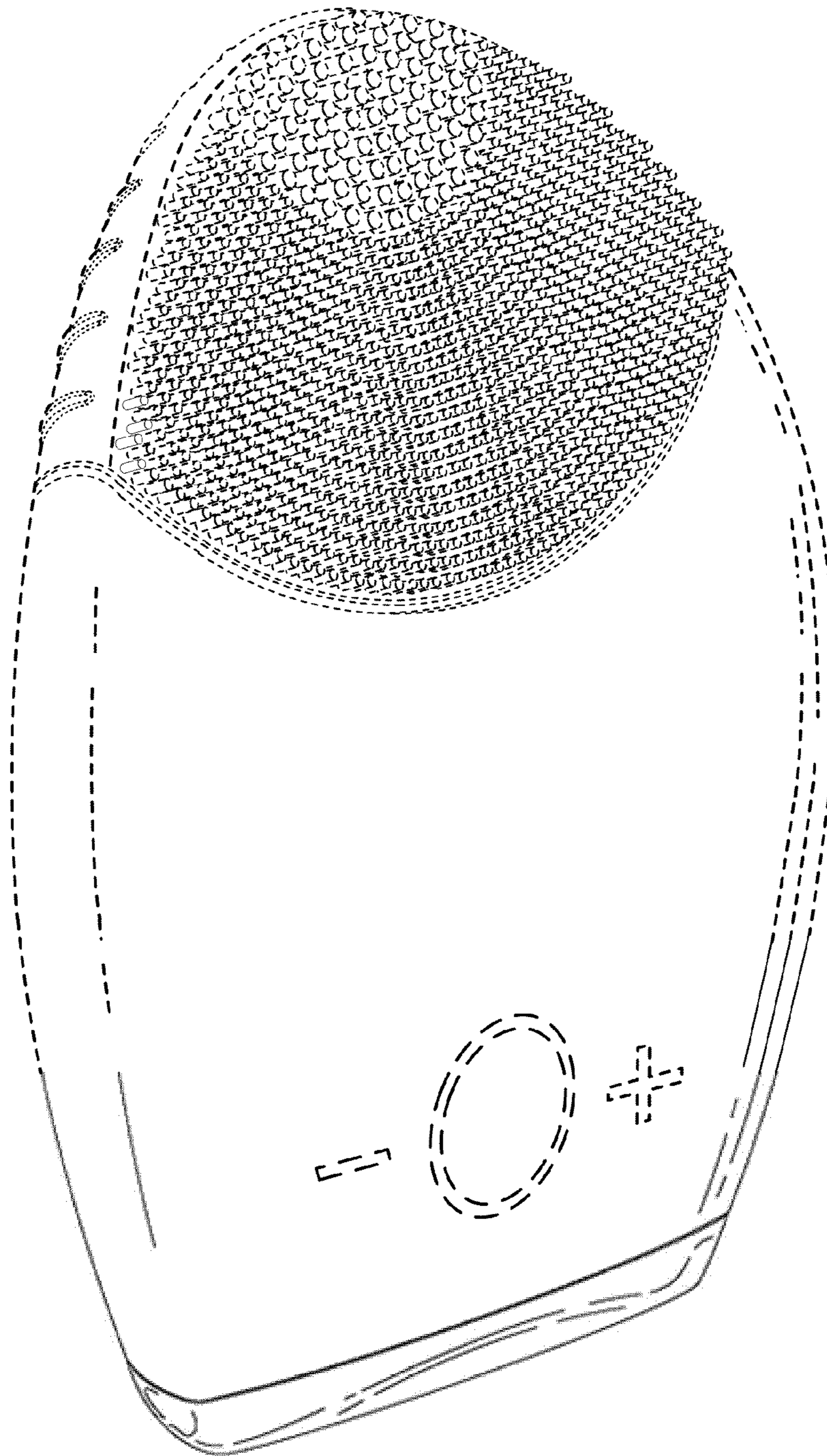

FIG. 8

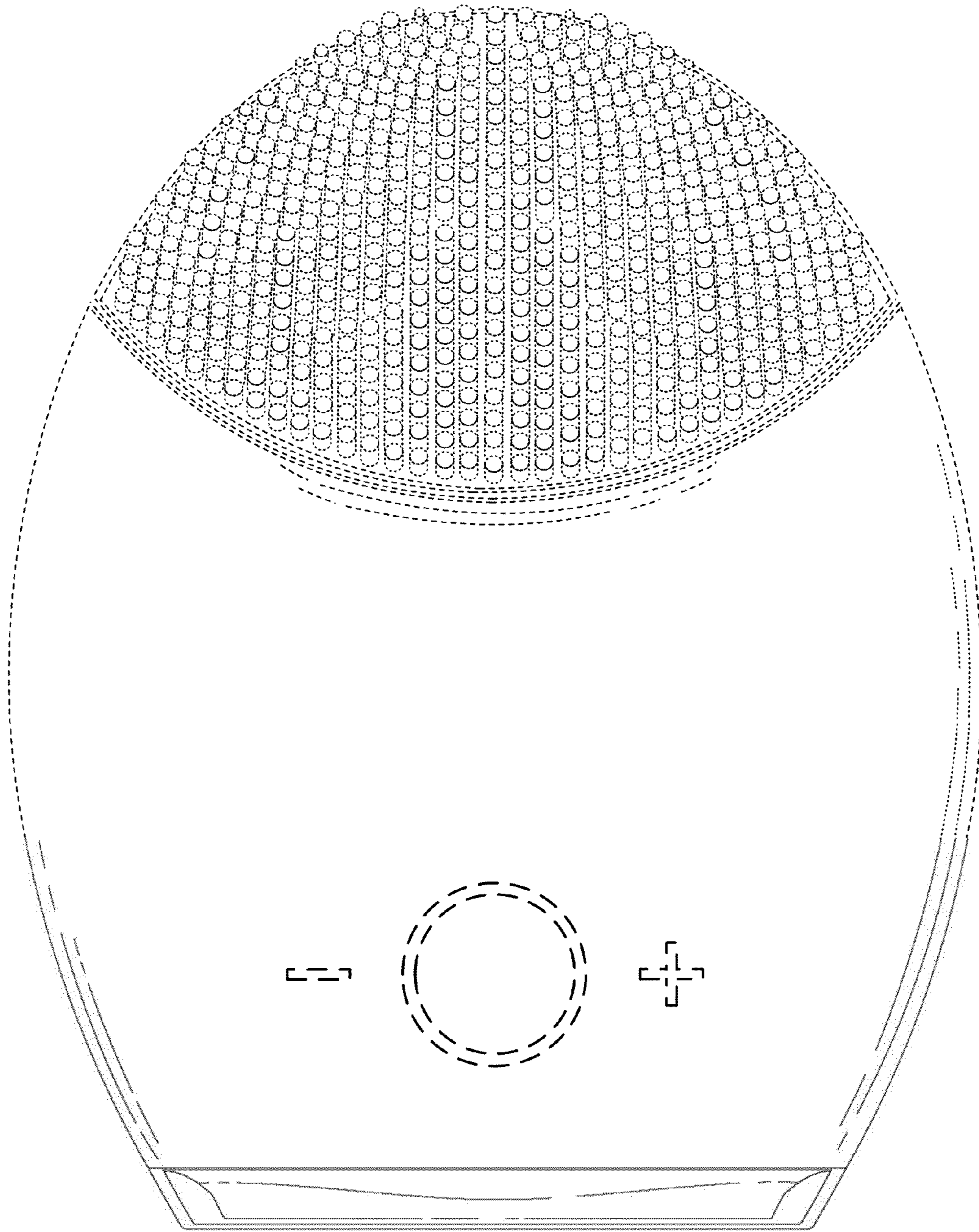

FIG. 9

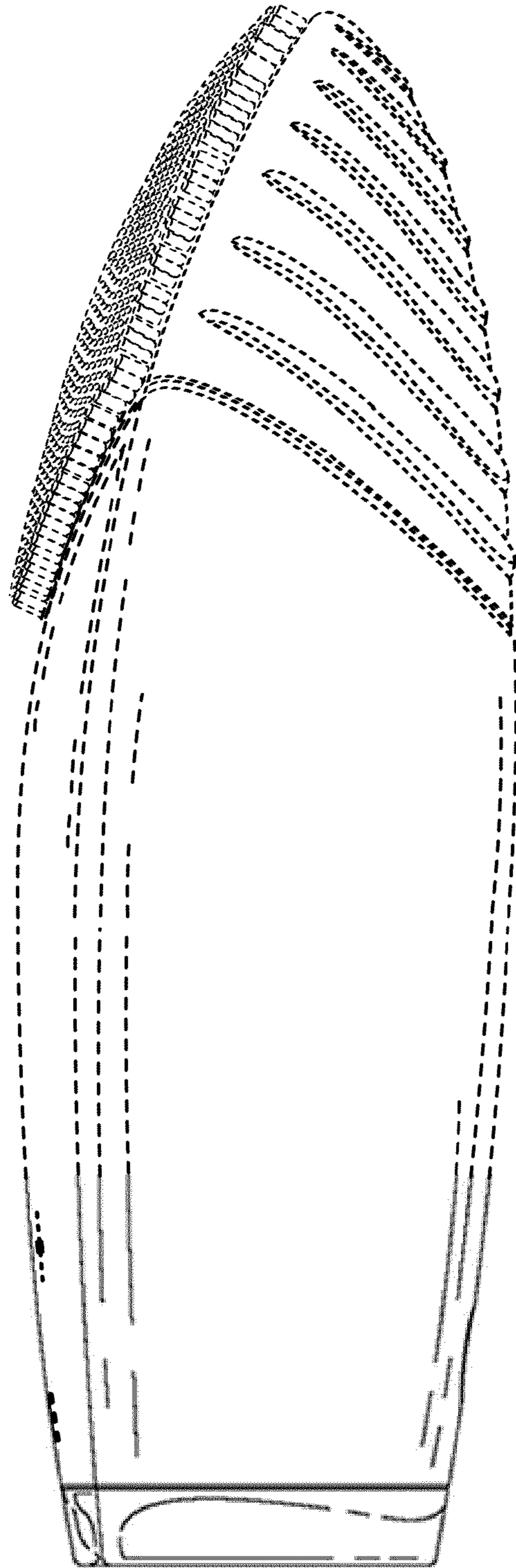

FIG. 10

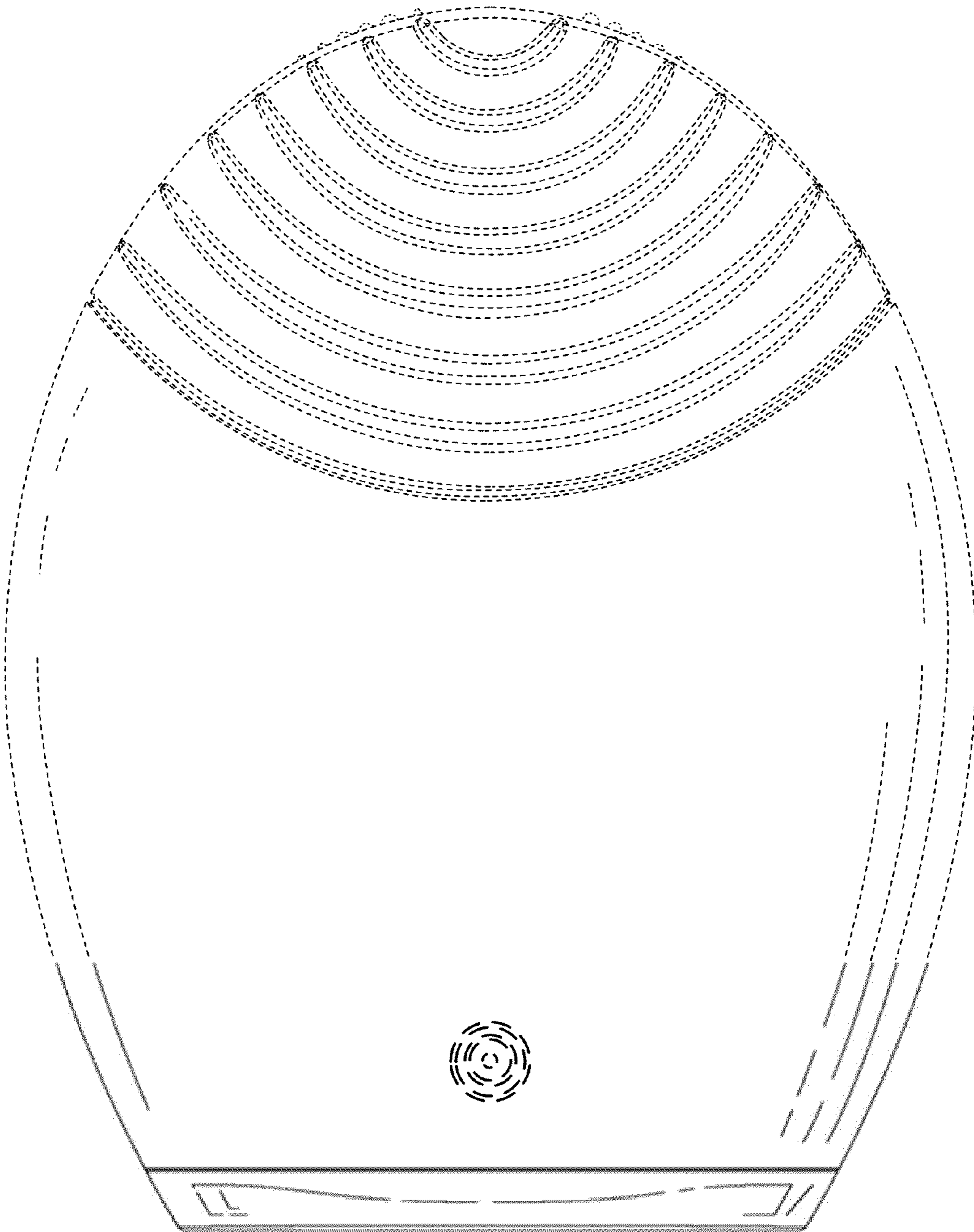

FIG. 11

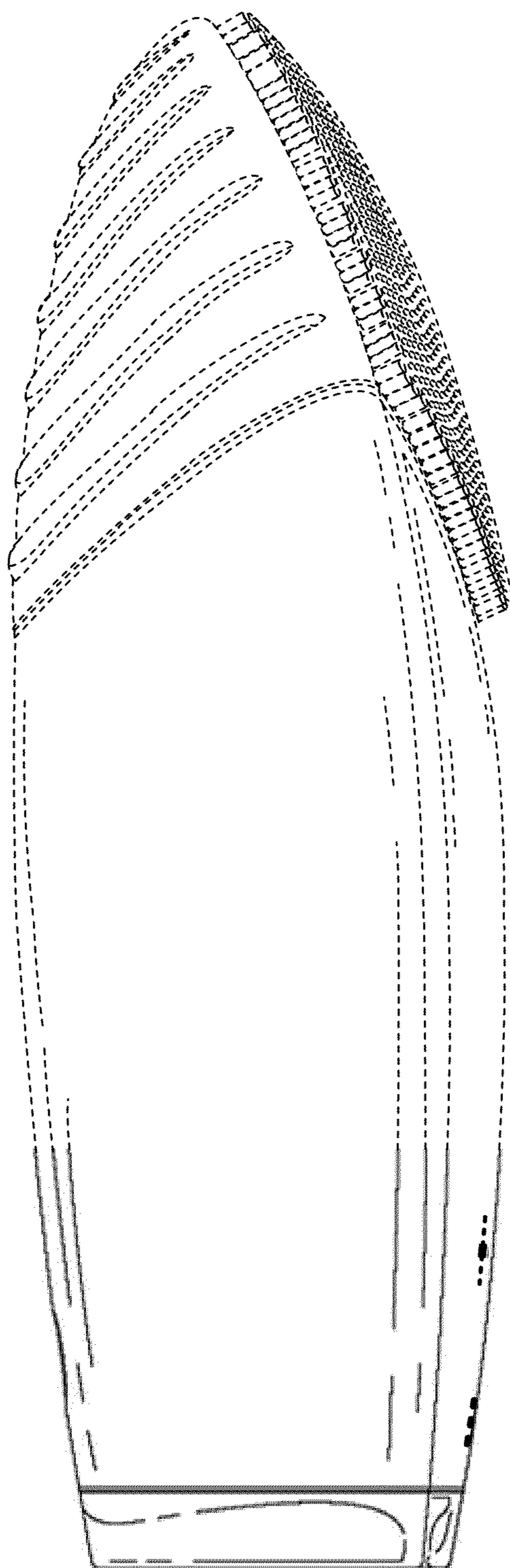

FIG. 12

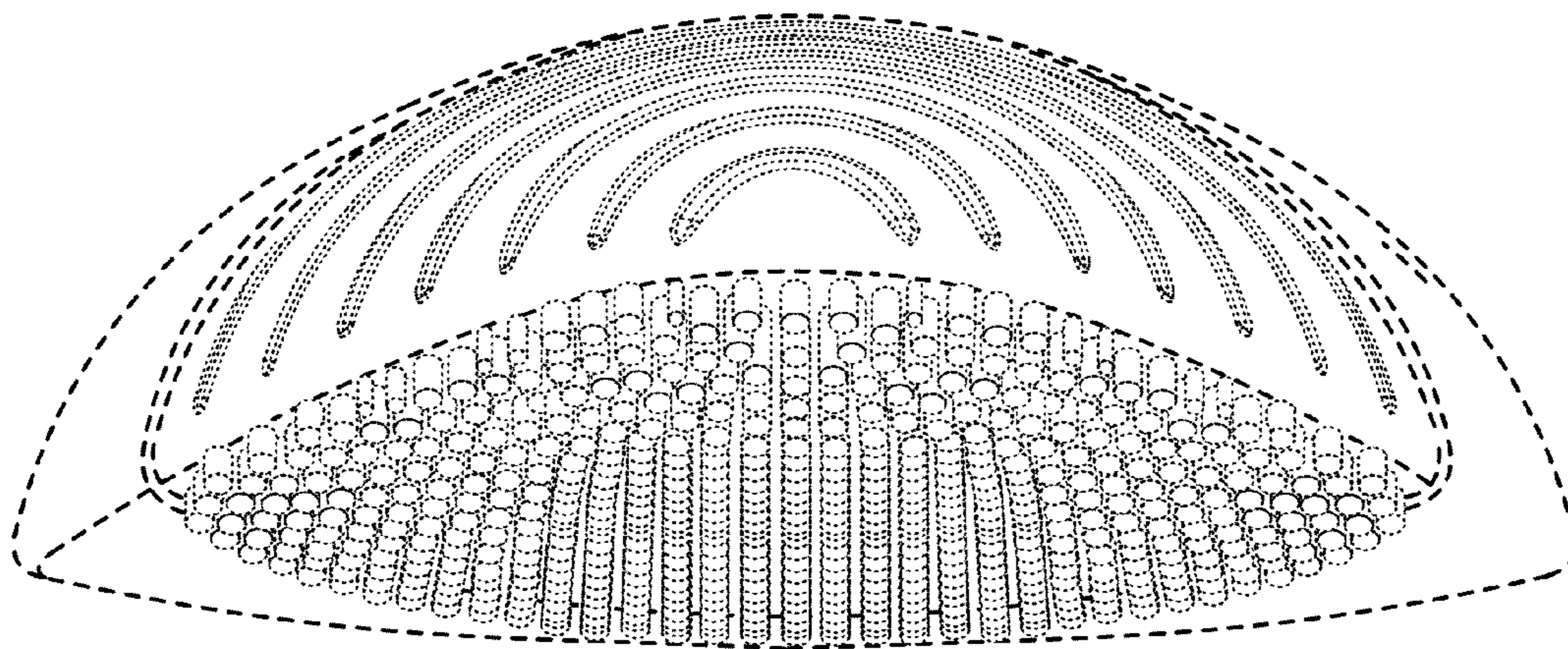

FIG. 13

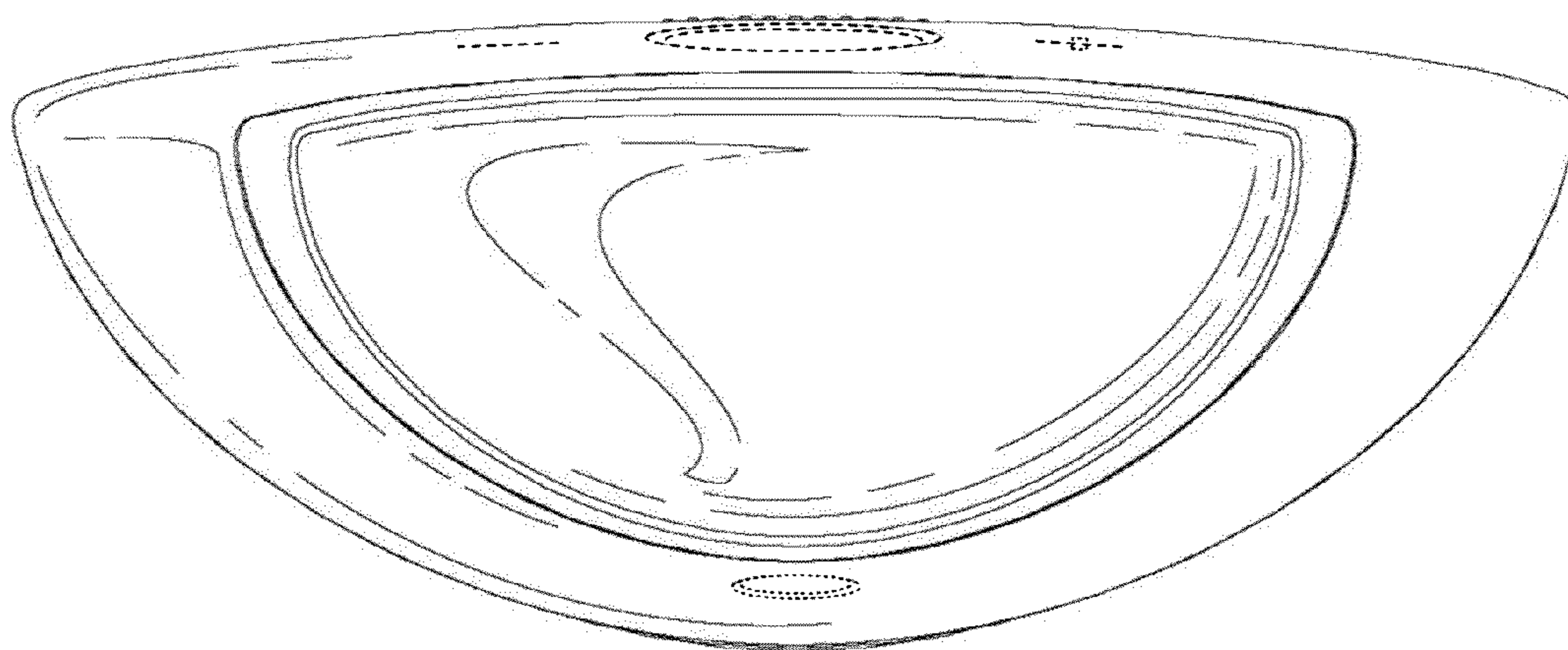

FIG. 14

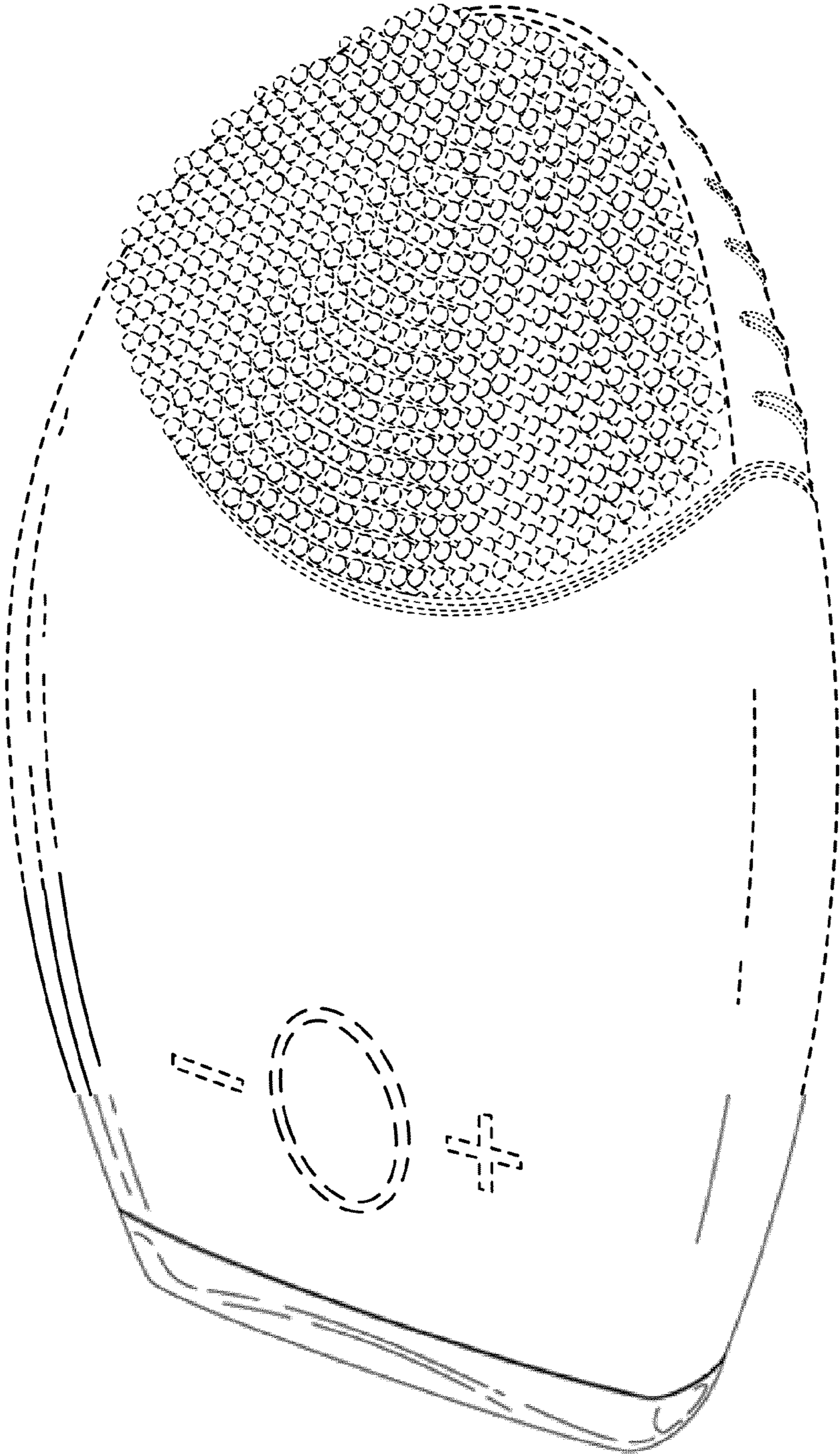

FIG. 15

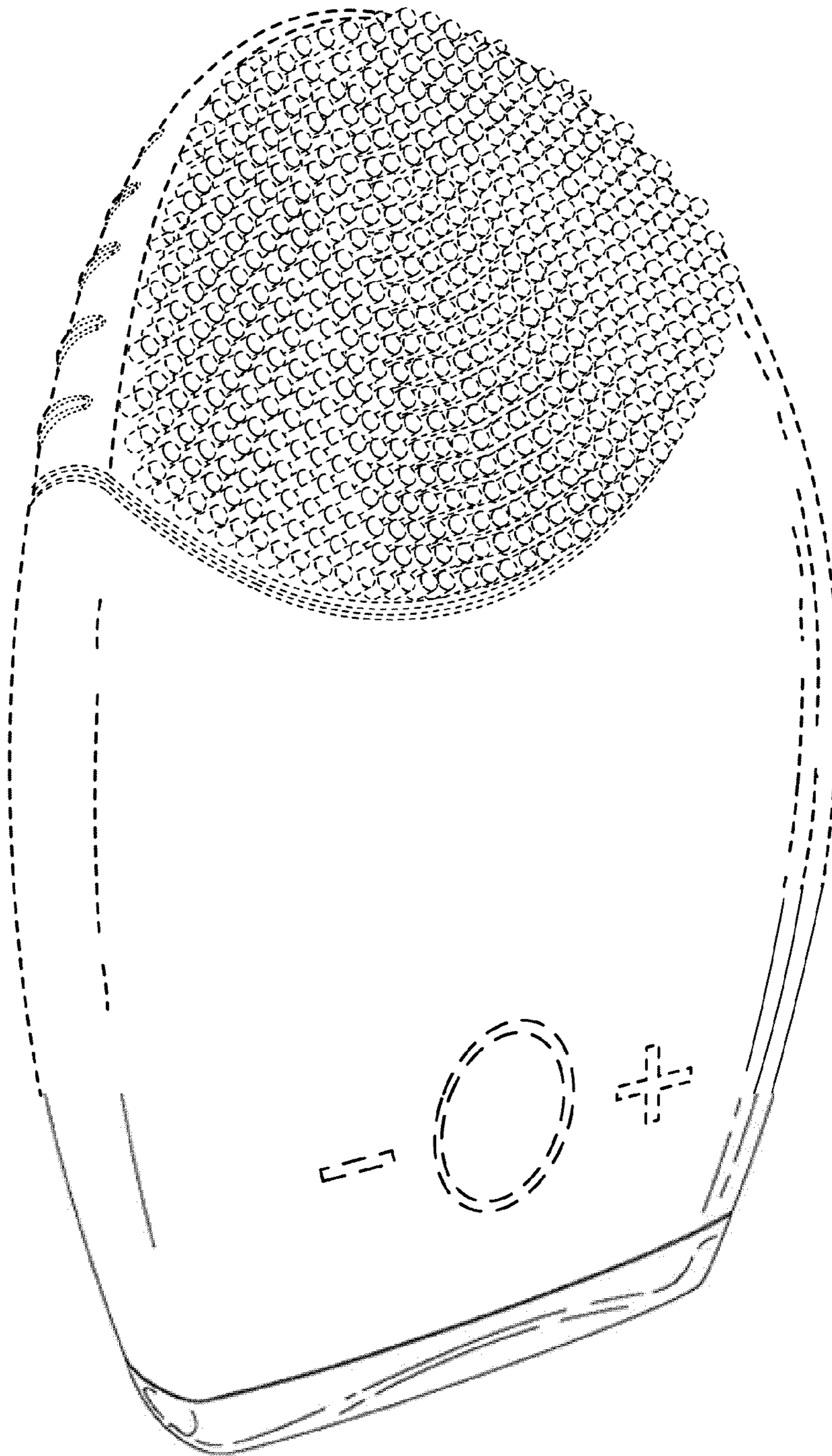

FIG. 16

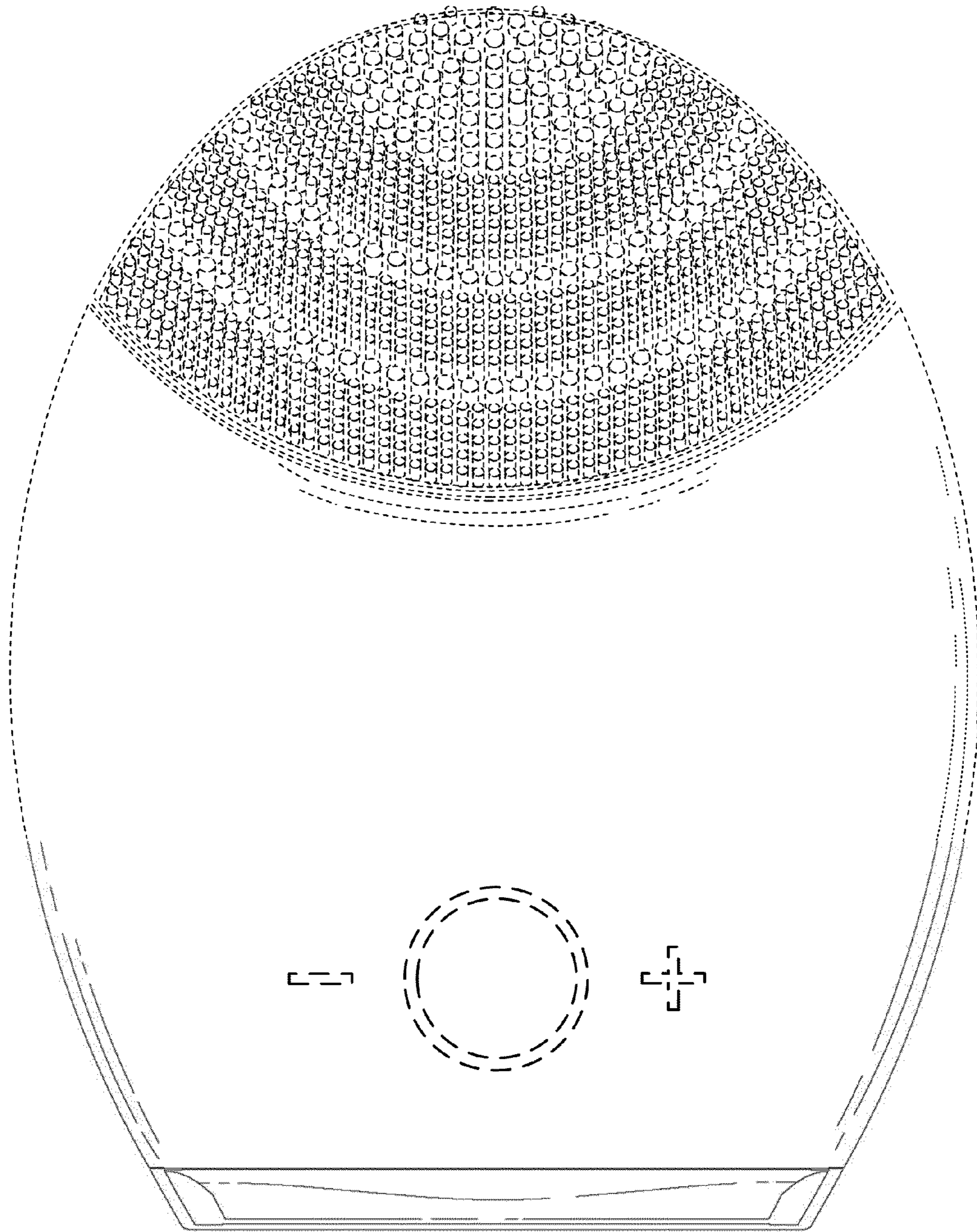

FIG. 17

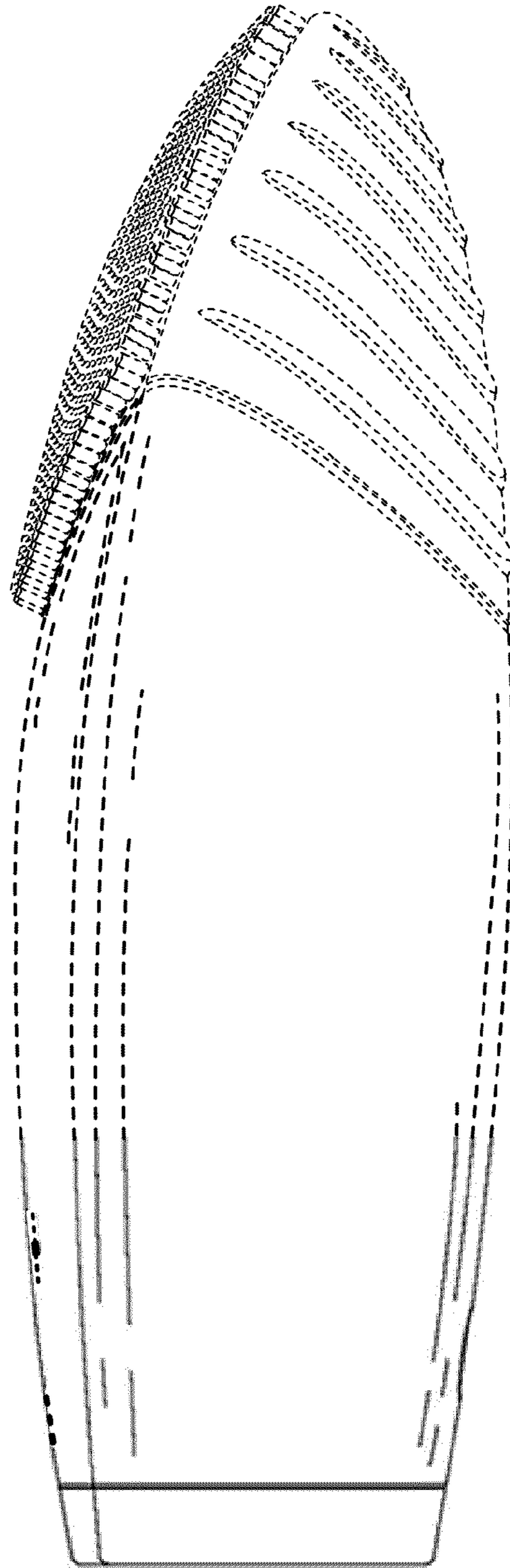

FIG. 18

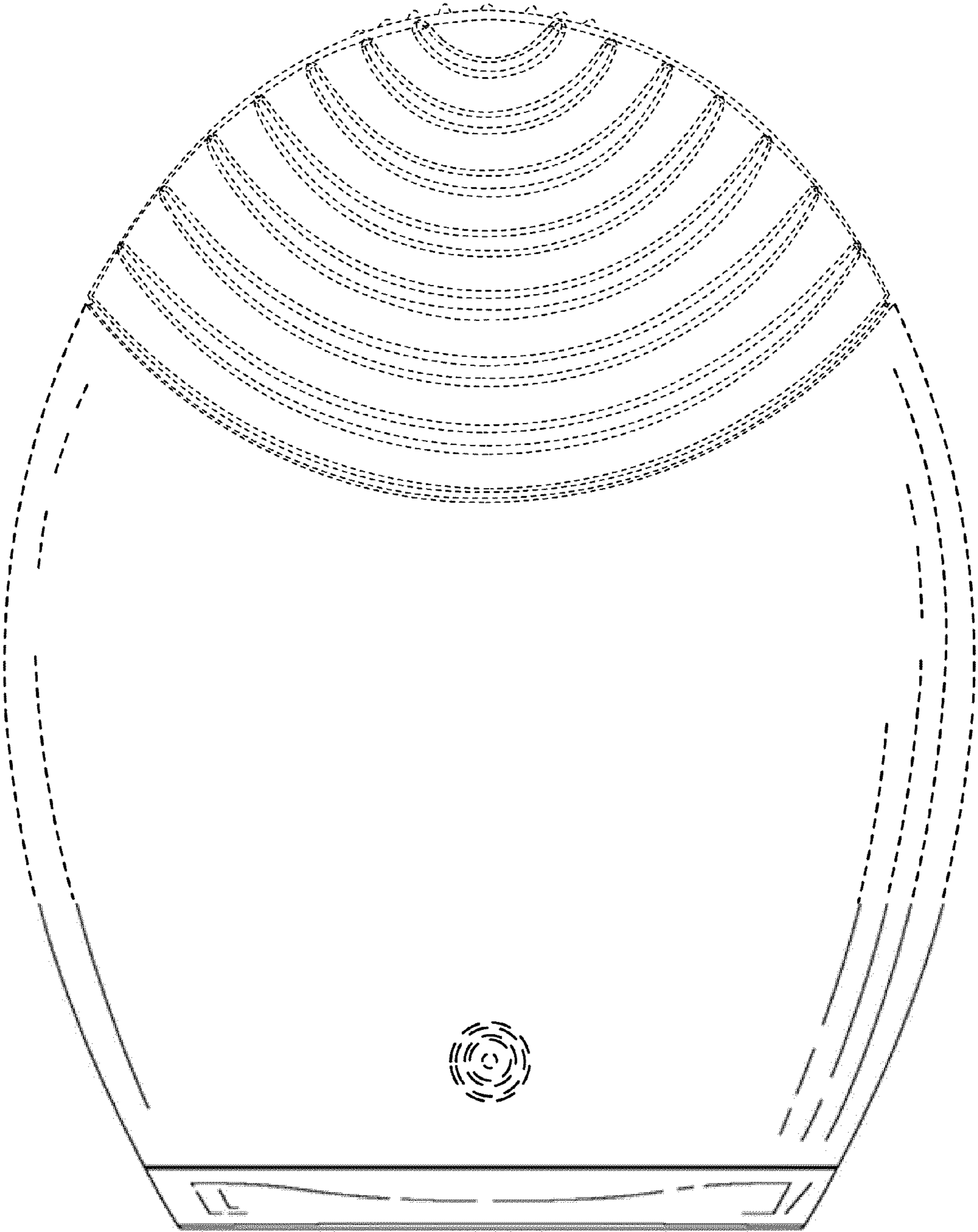

FIG. 19

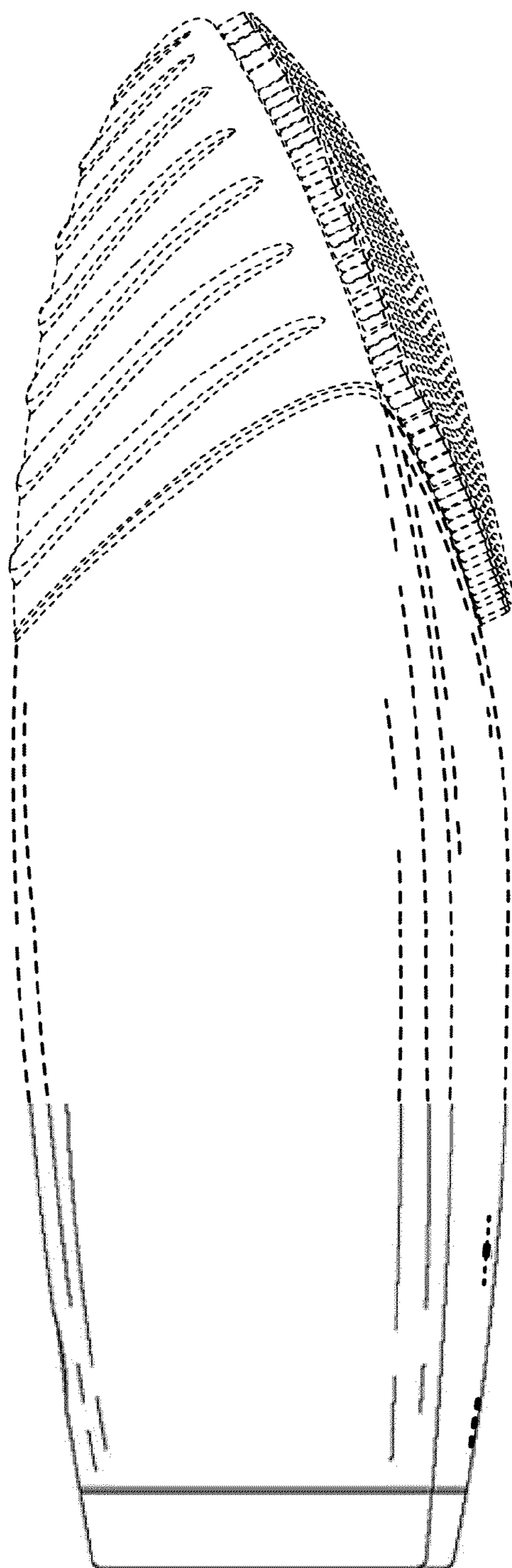

FIG. 20

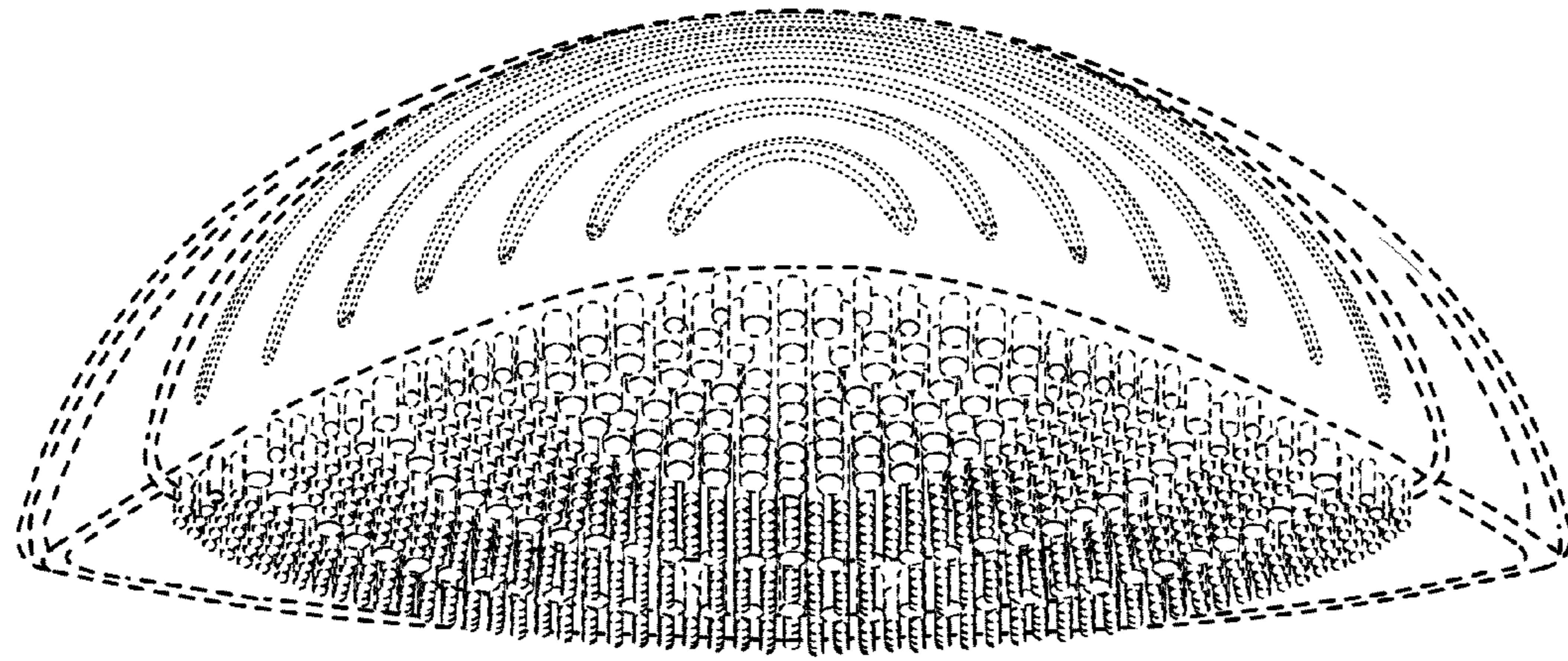

FIG. 21

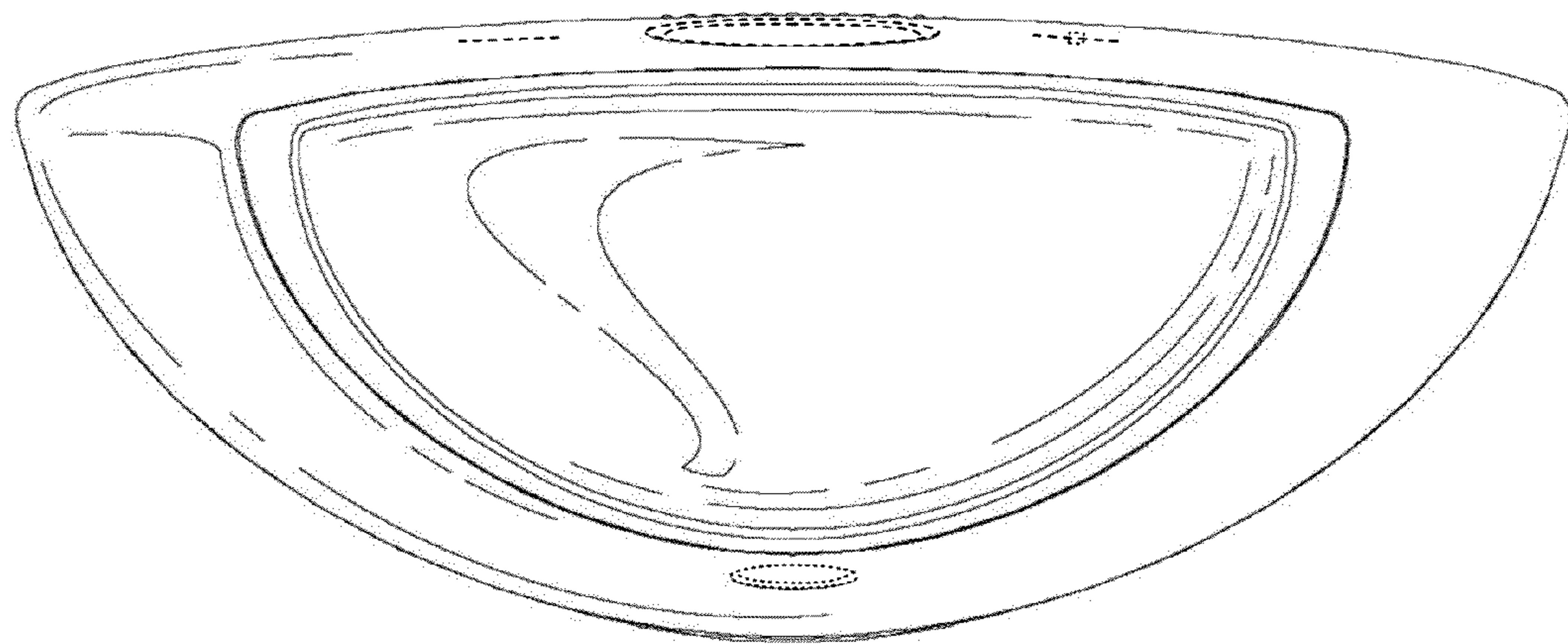

FIG. 22

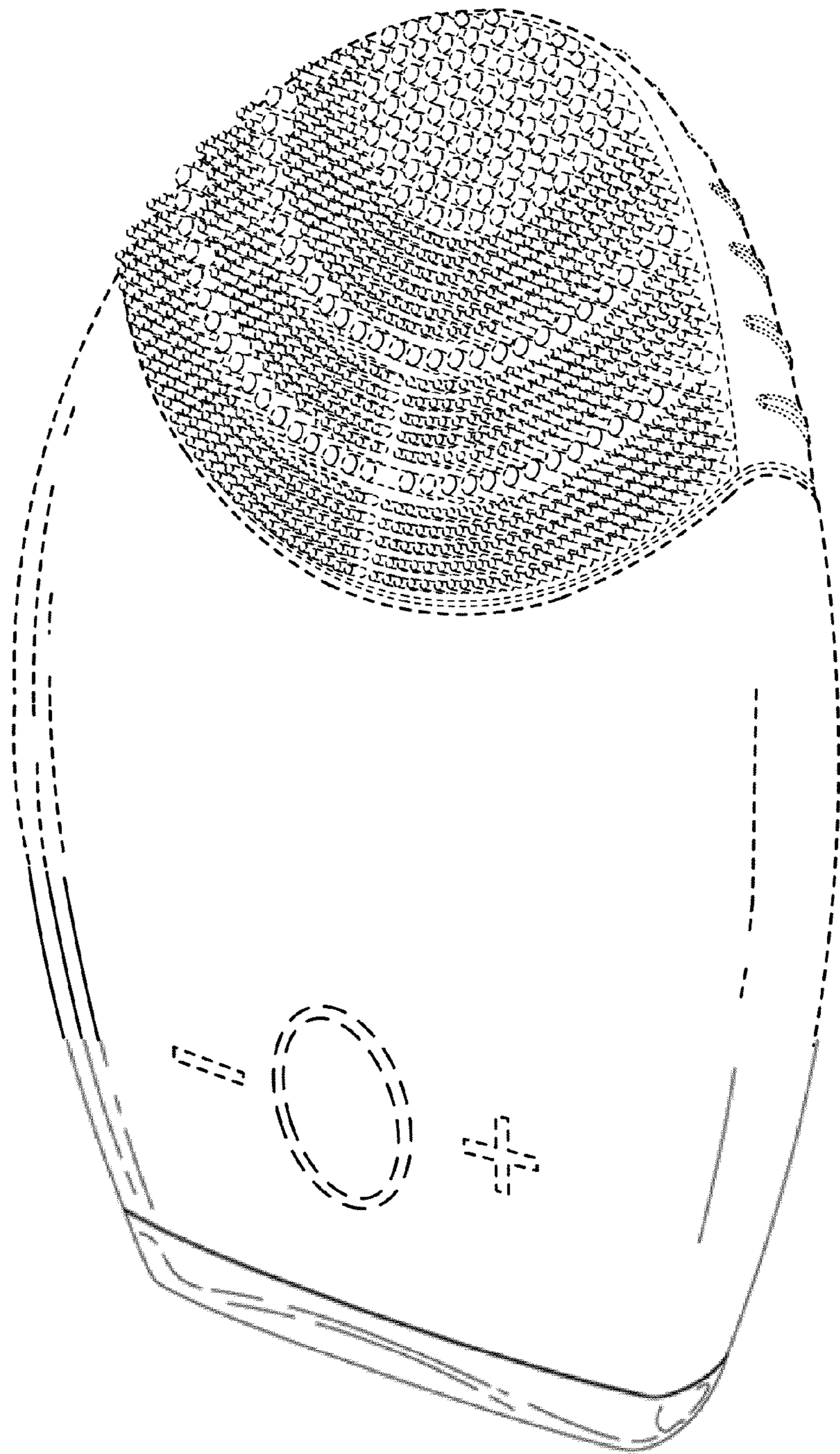

FIG. 23

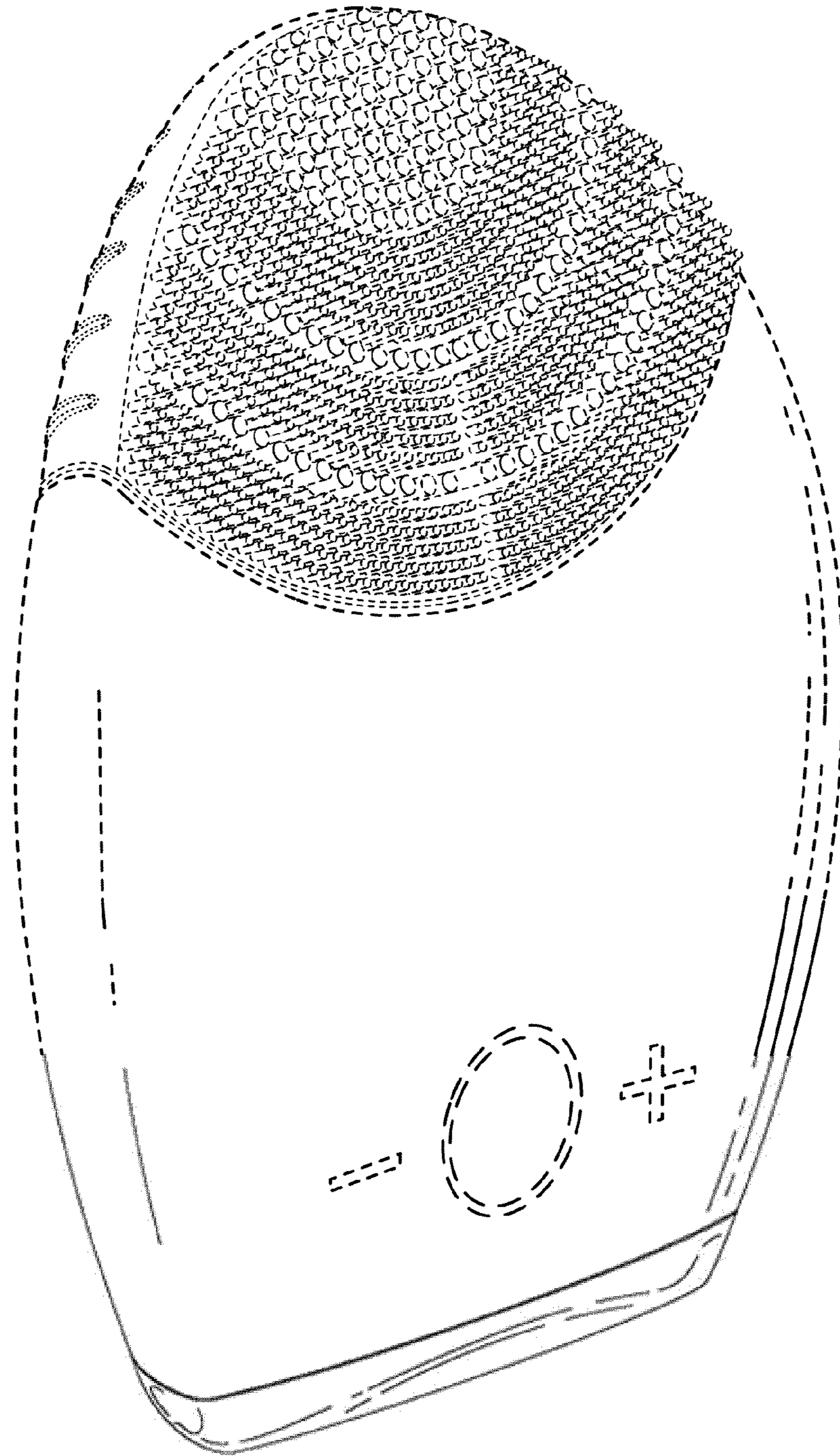

FIG. 24

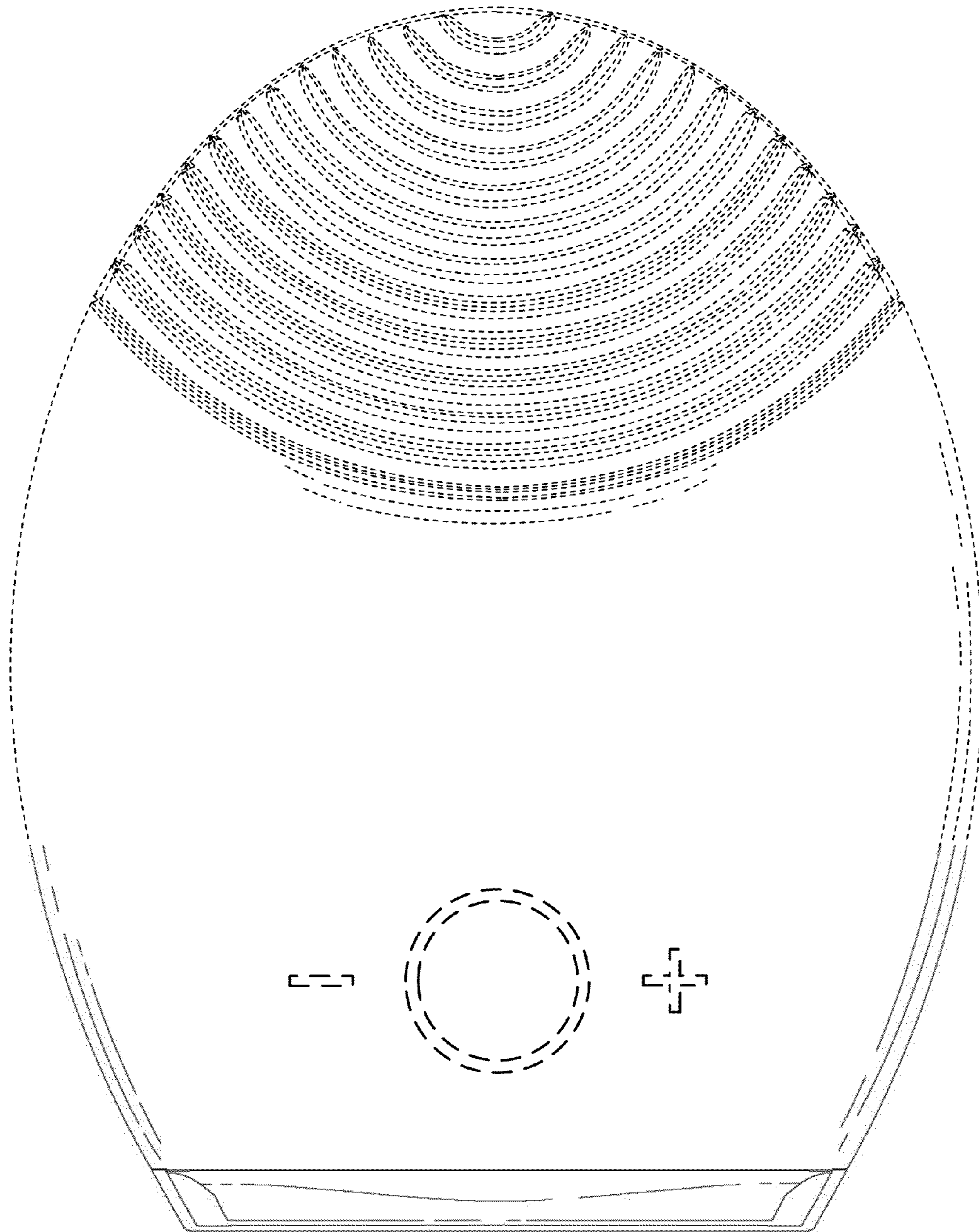

FIG. 25

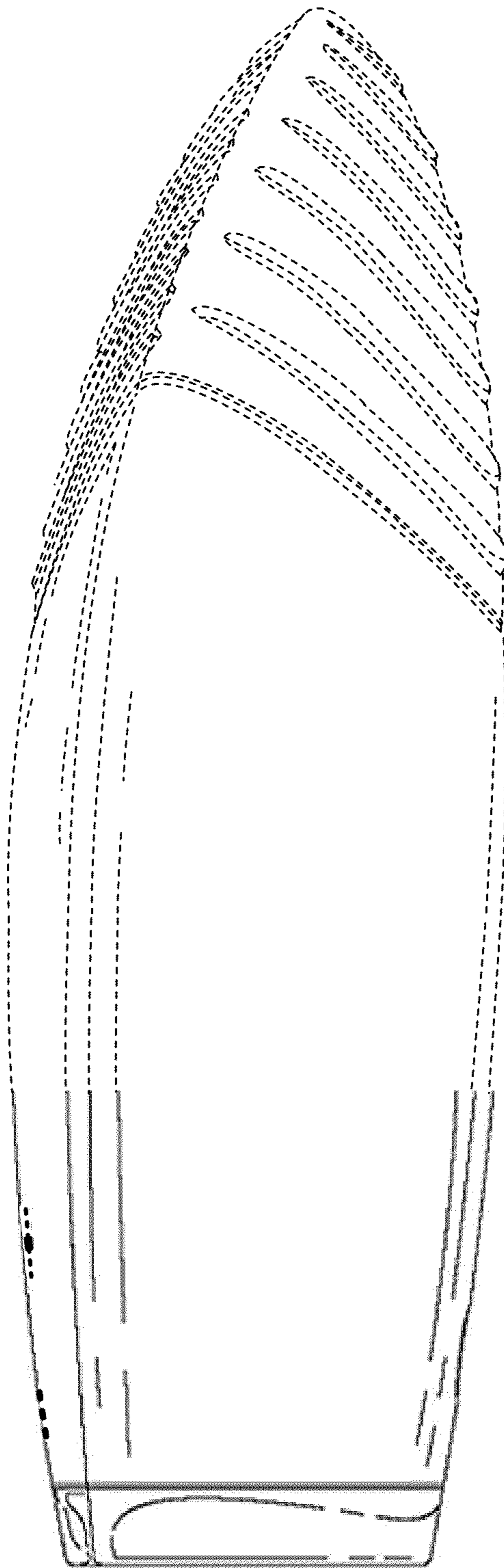

FIG. 26

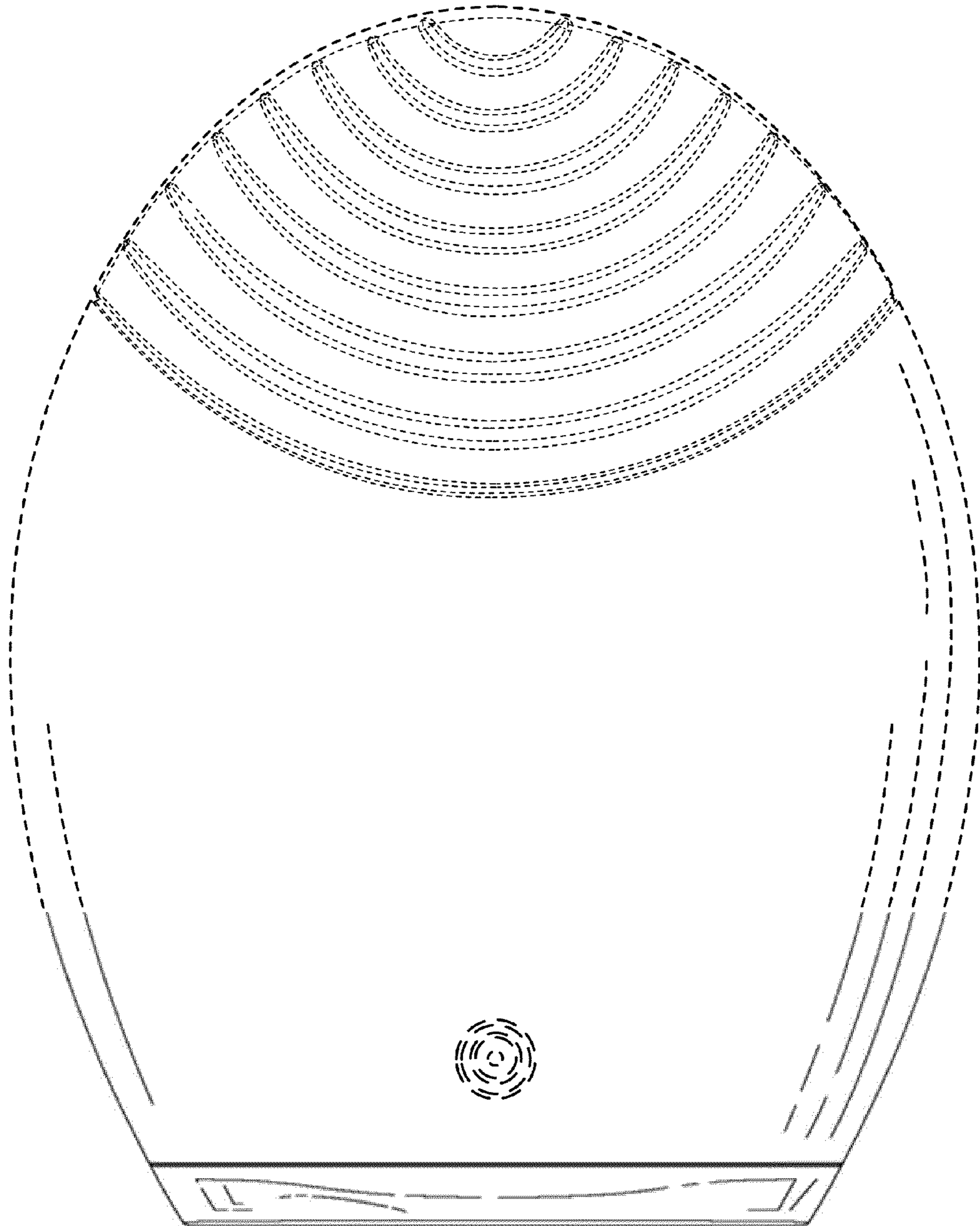

FIG. 27

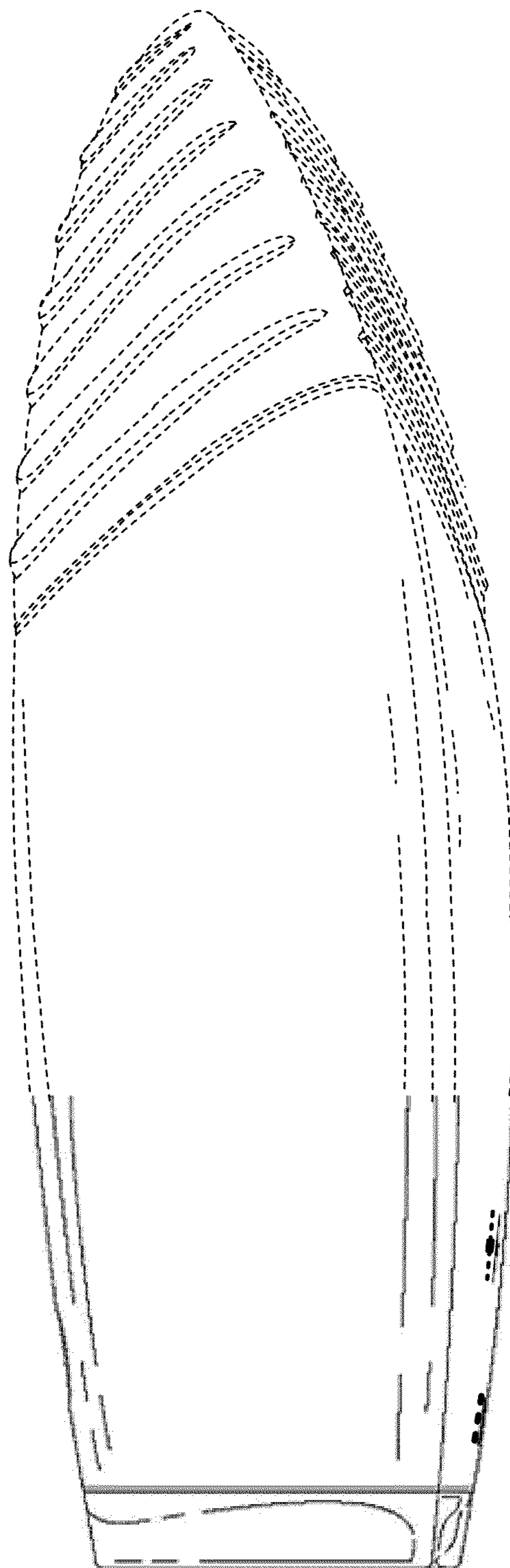

FIG. 28

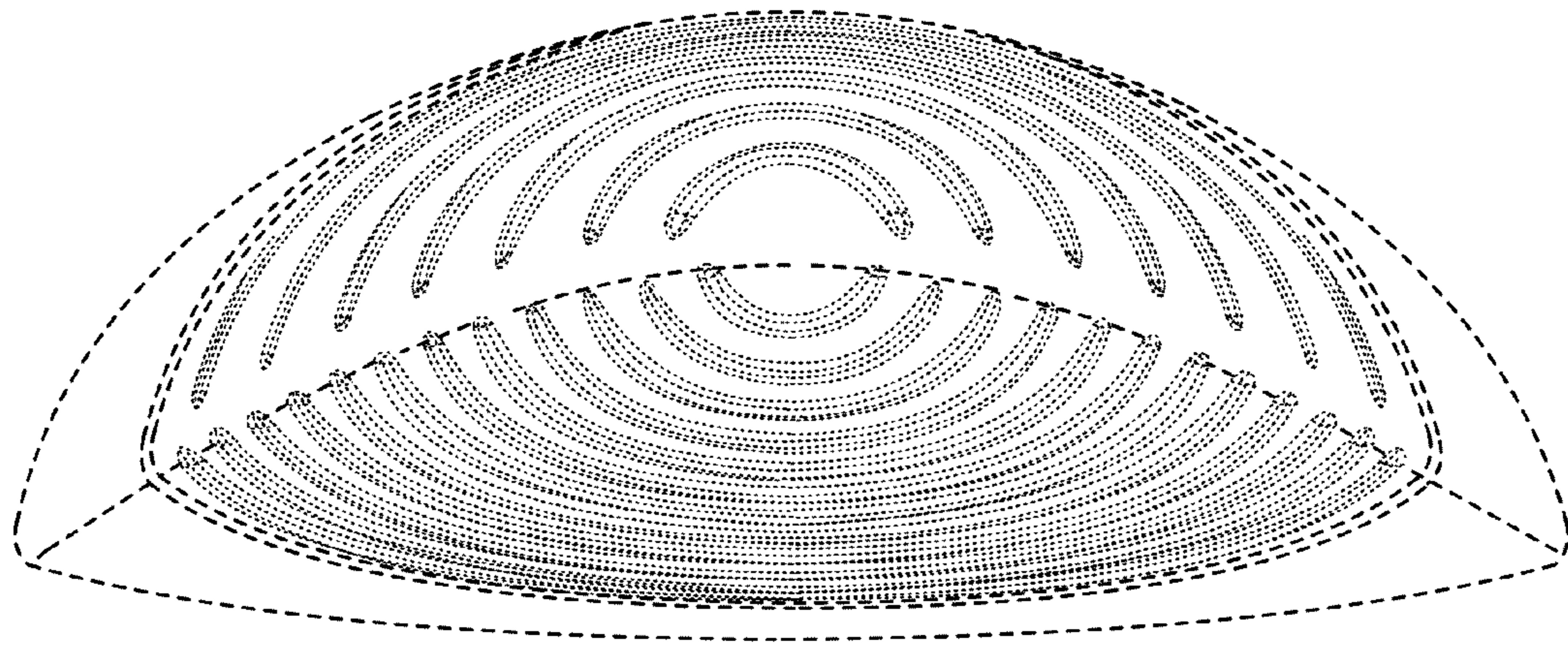

FIG. 29

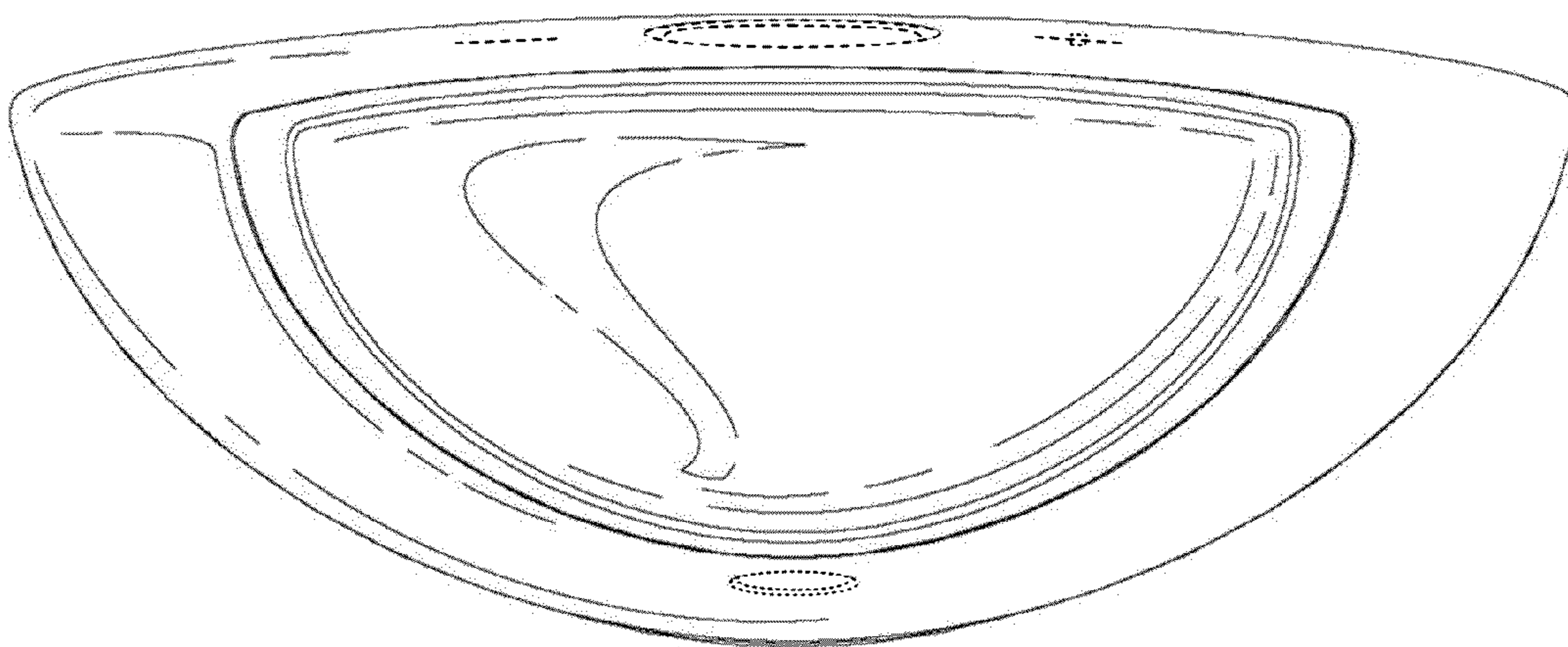

FIG. 30

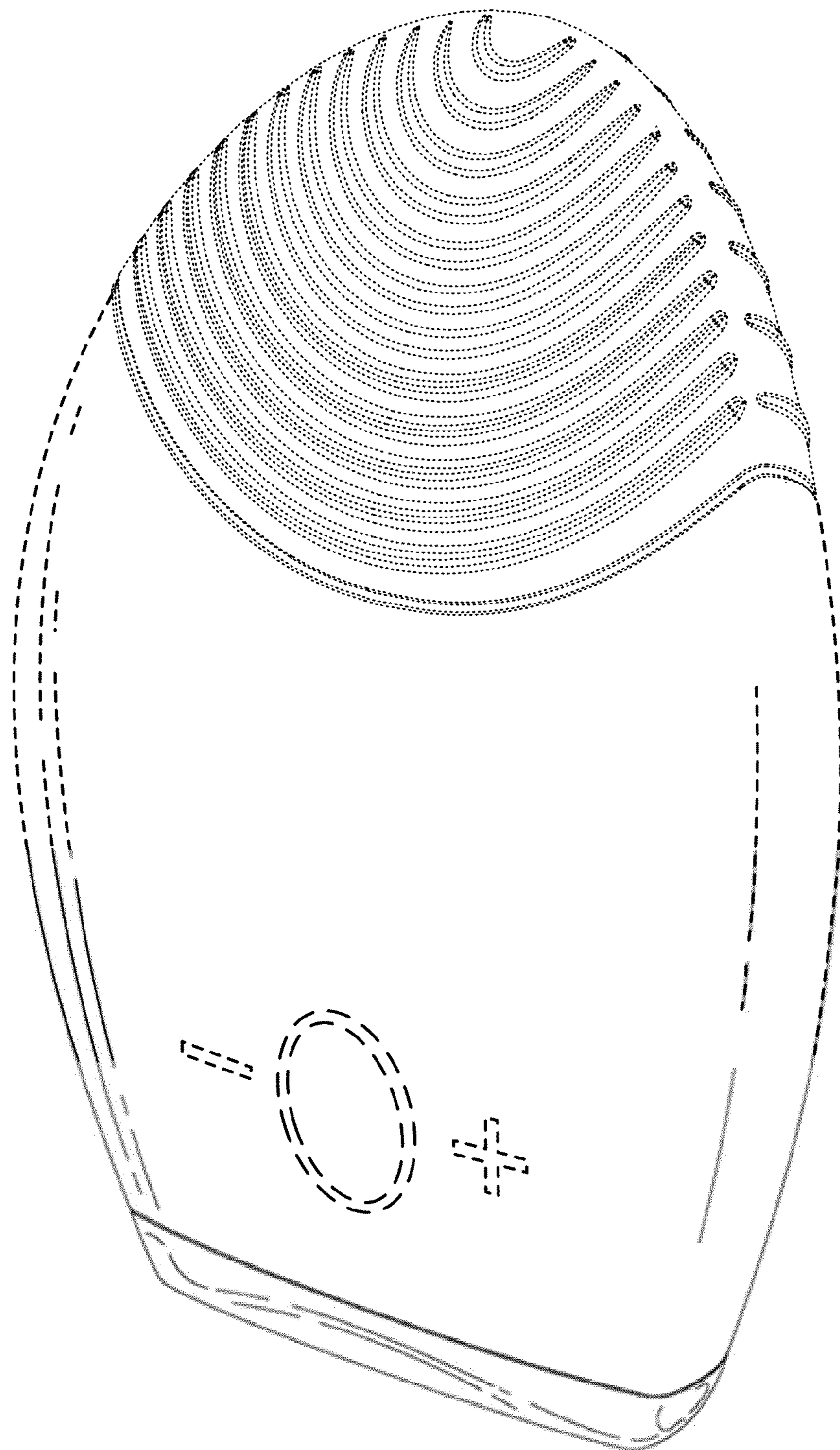

FIG. 31

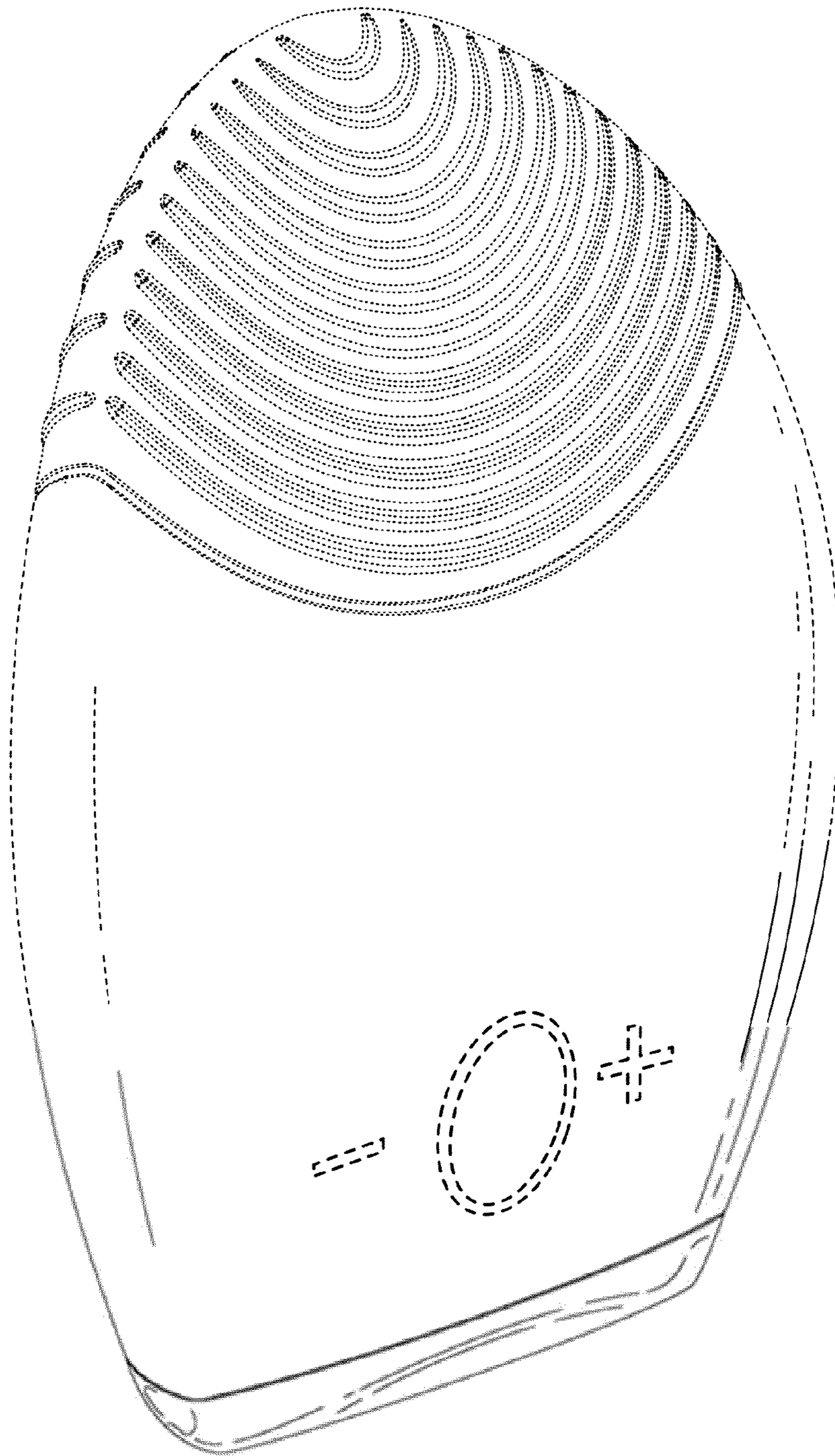

FIG. 32

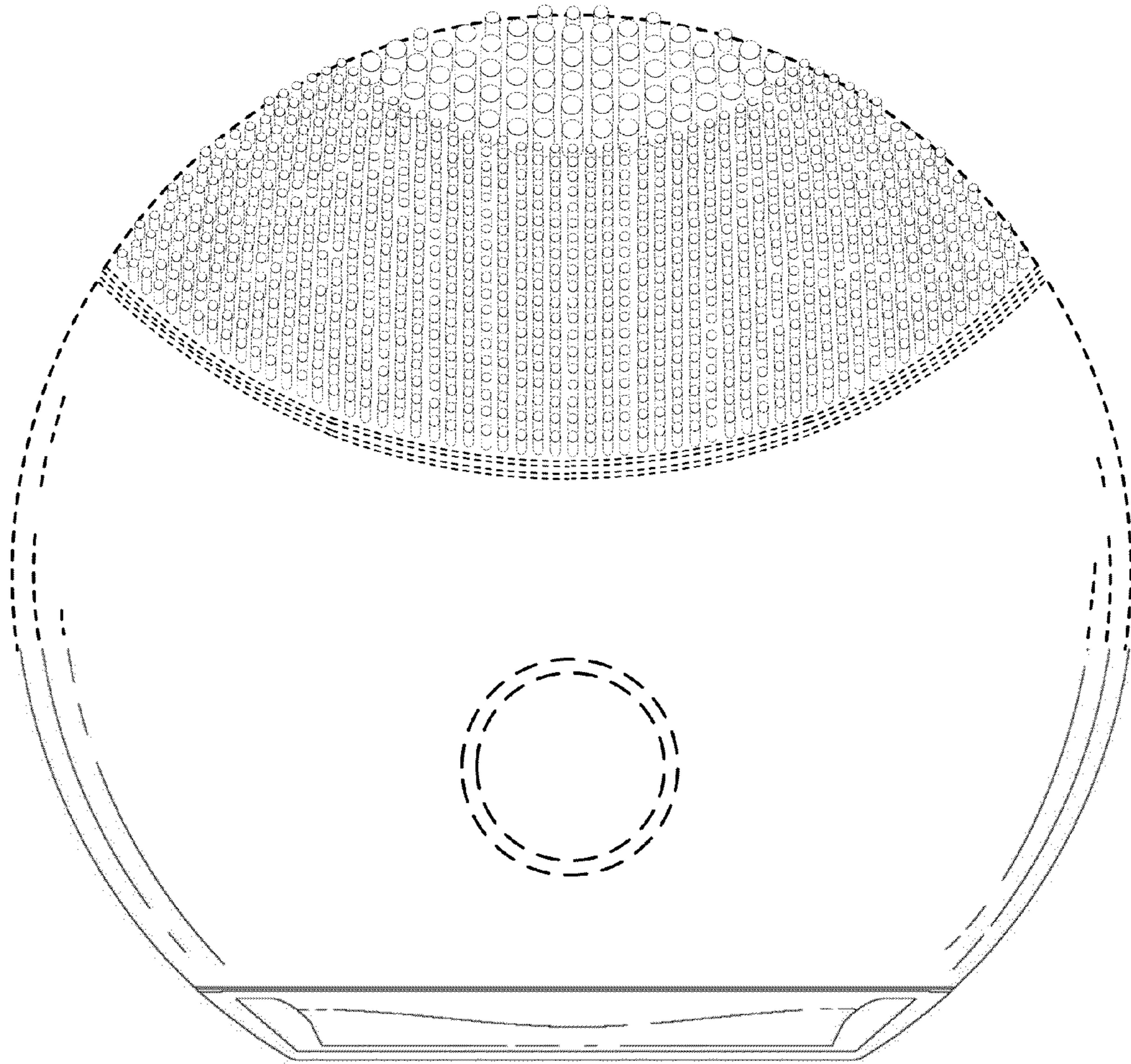

FIG. 33

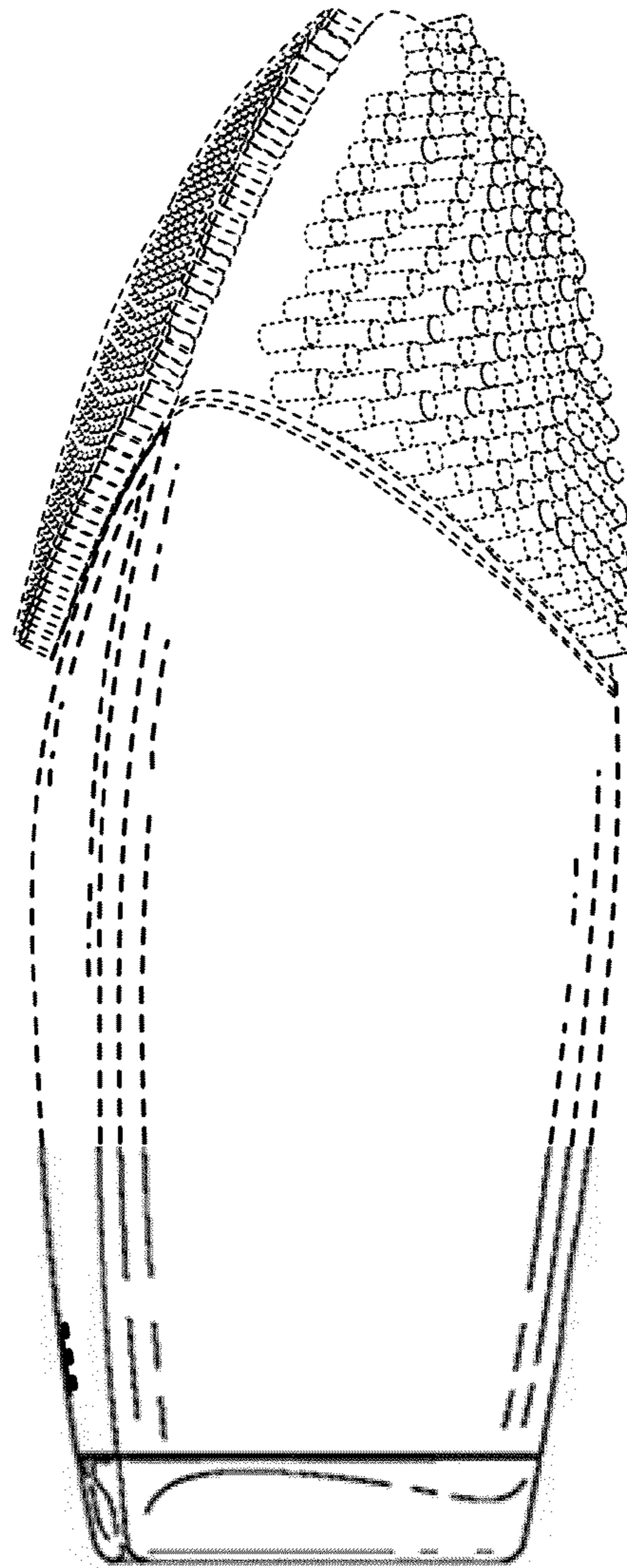

FIG. 34

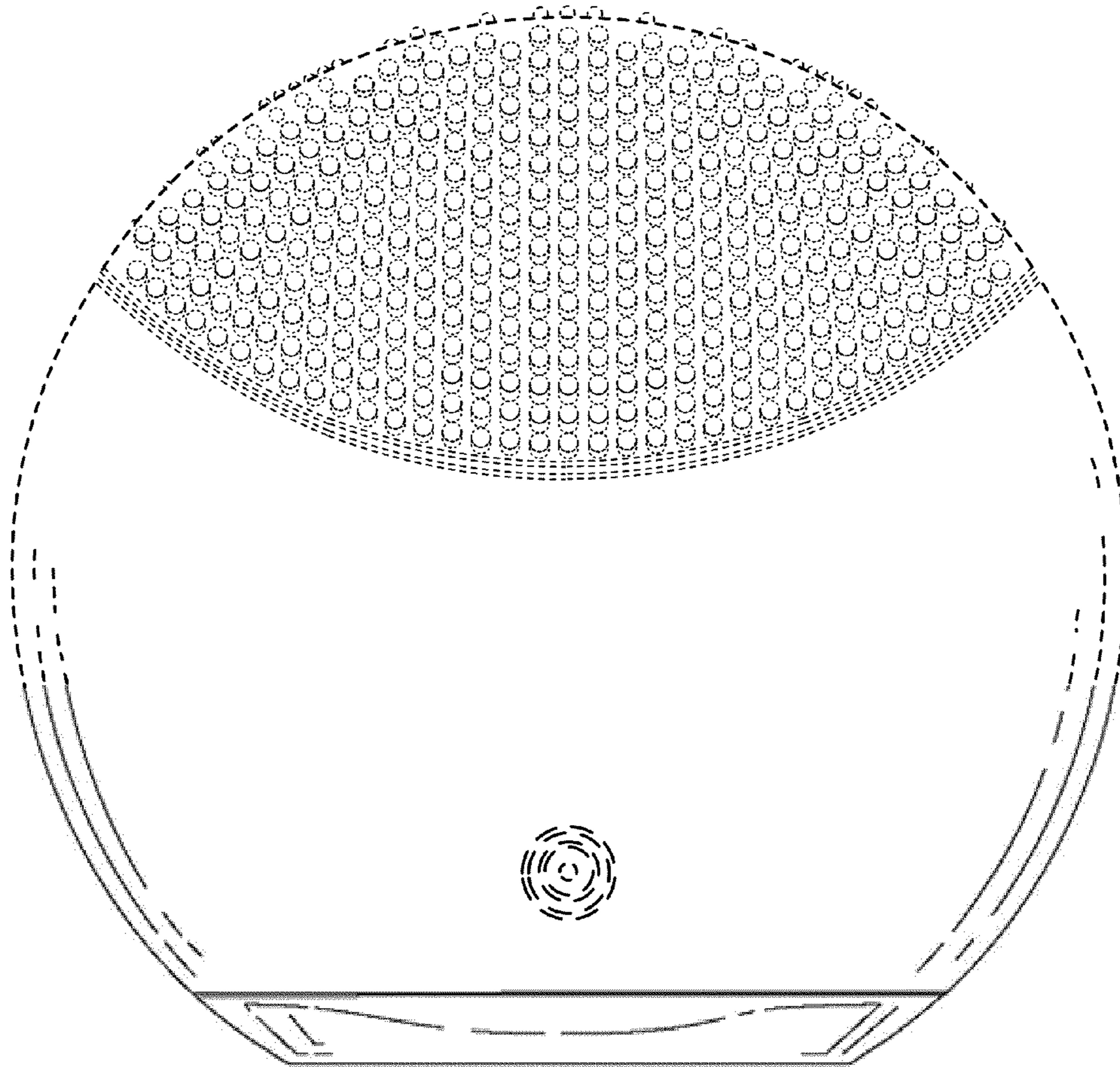

FIG. 35

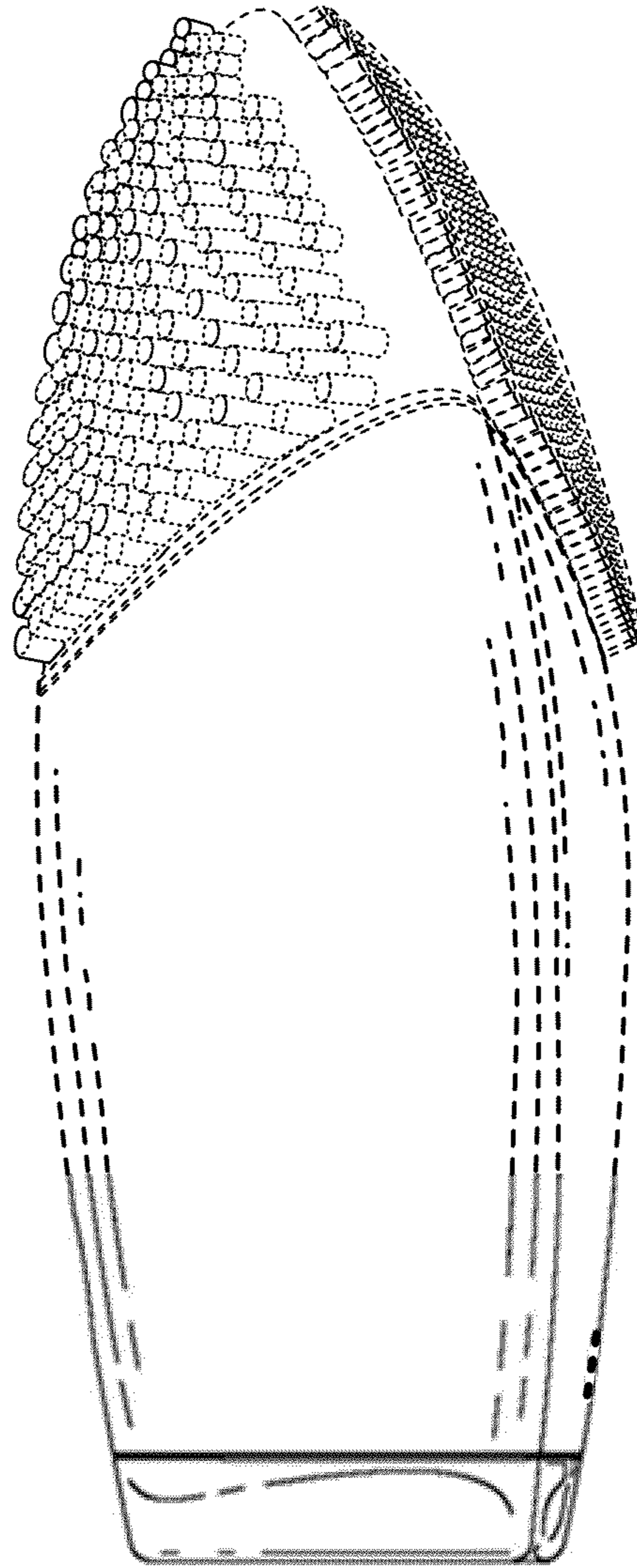

FIG. 36

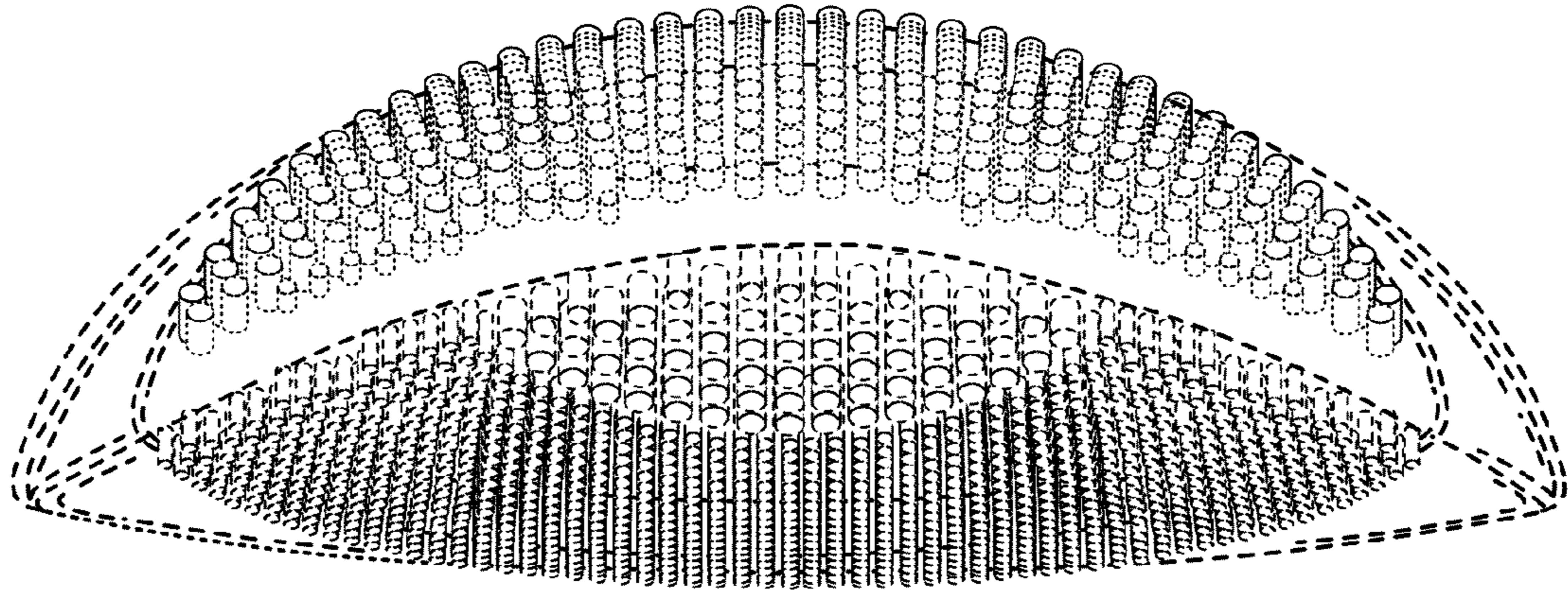

FIG. 37

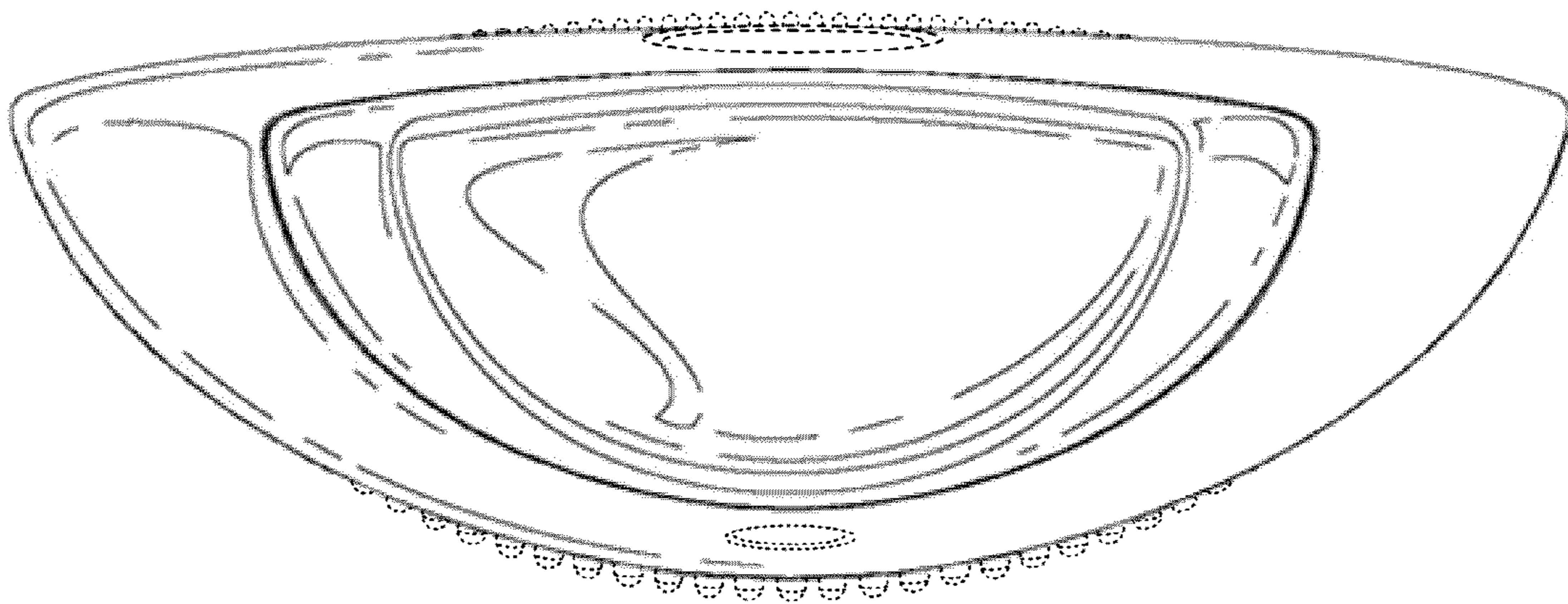

FIG. 38

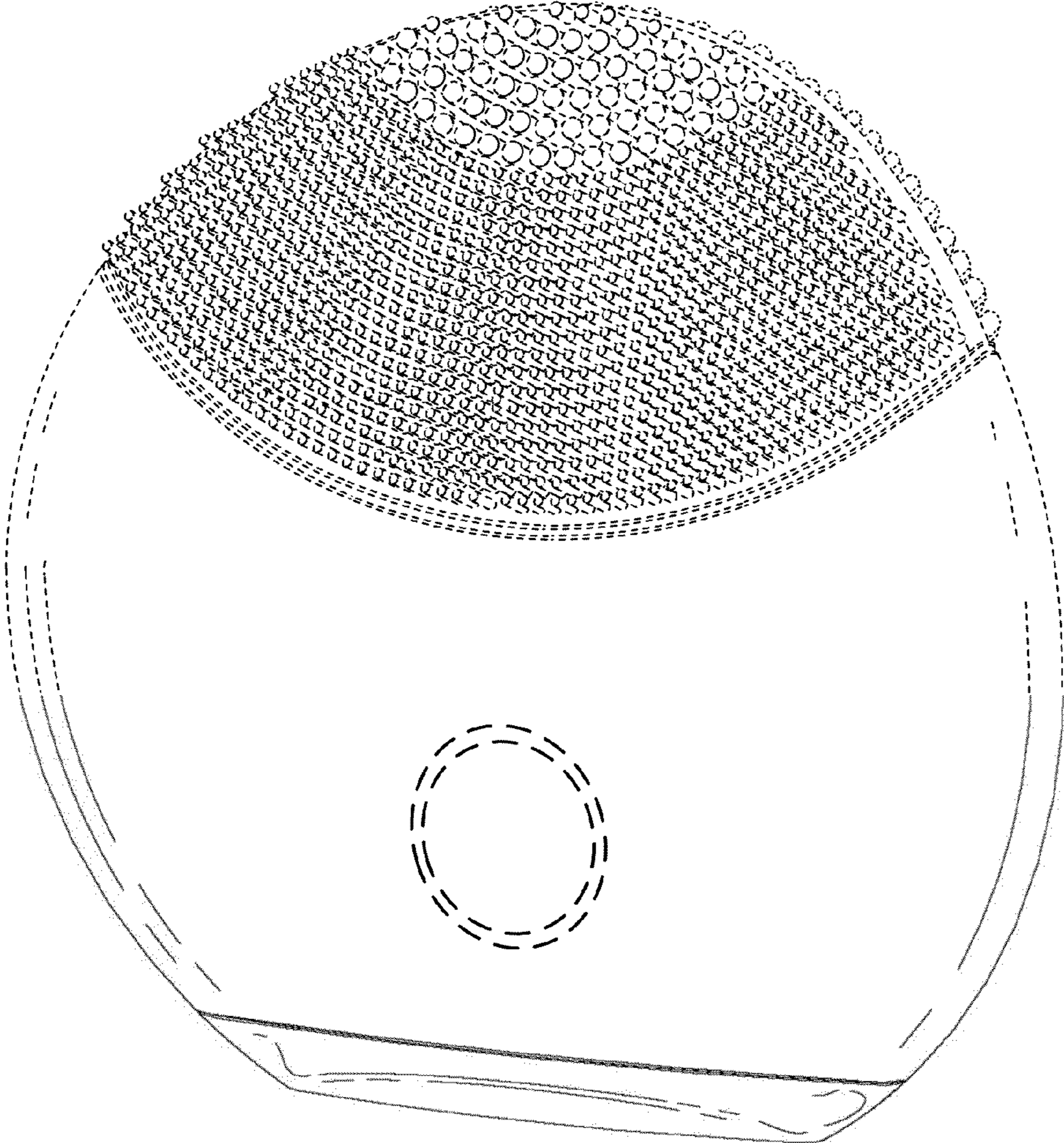

FIG. 39

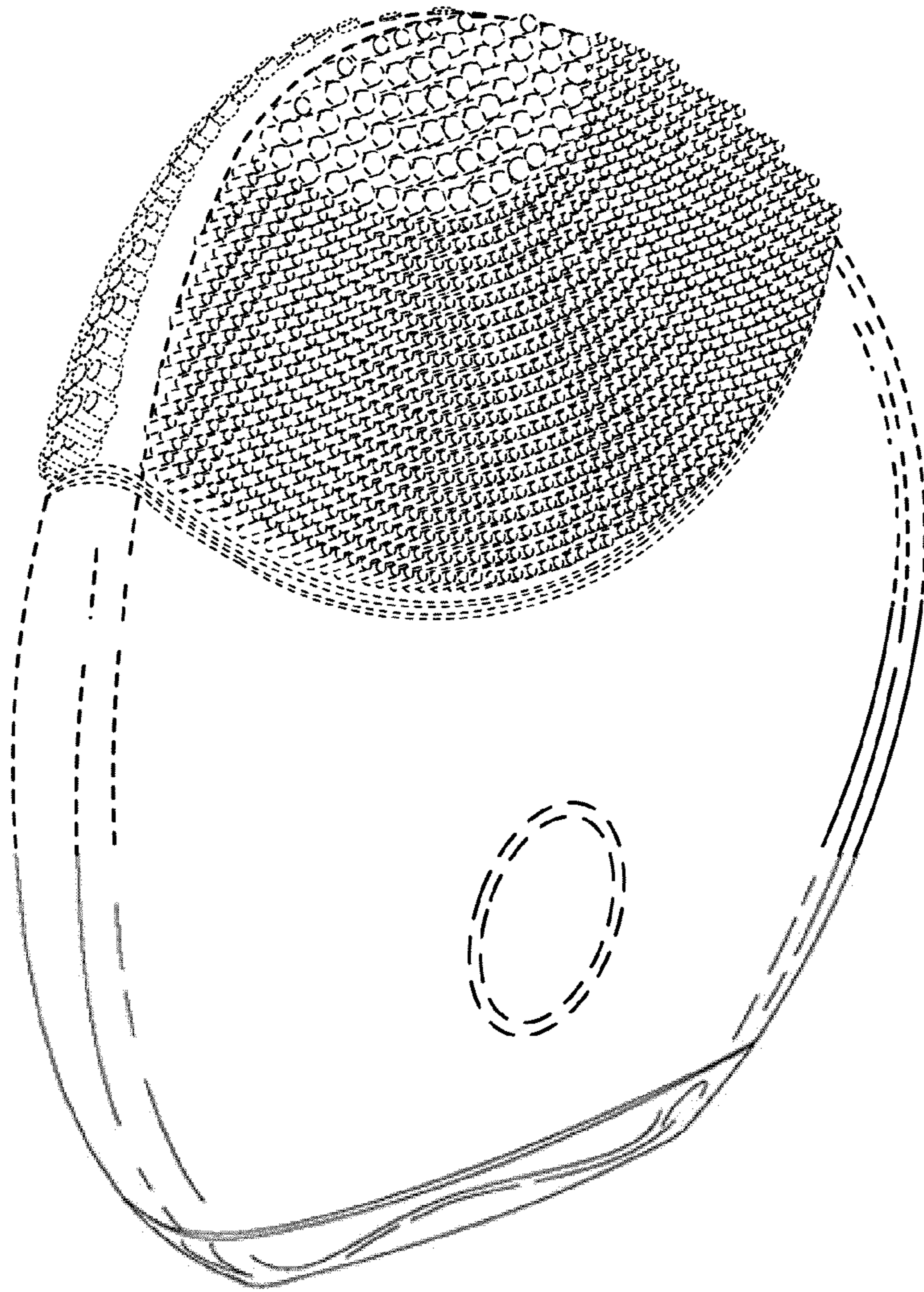

FIG. 40

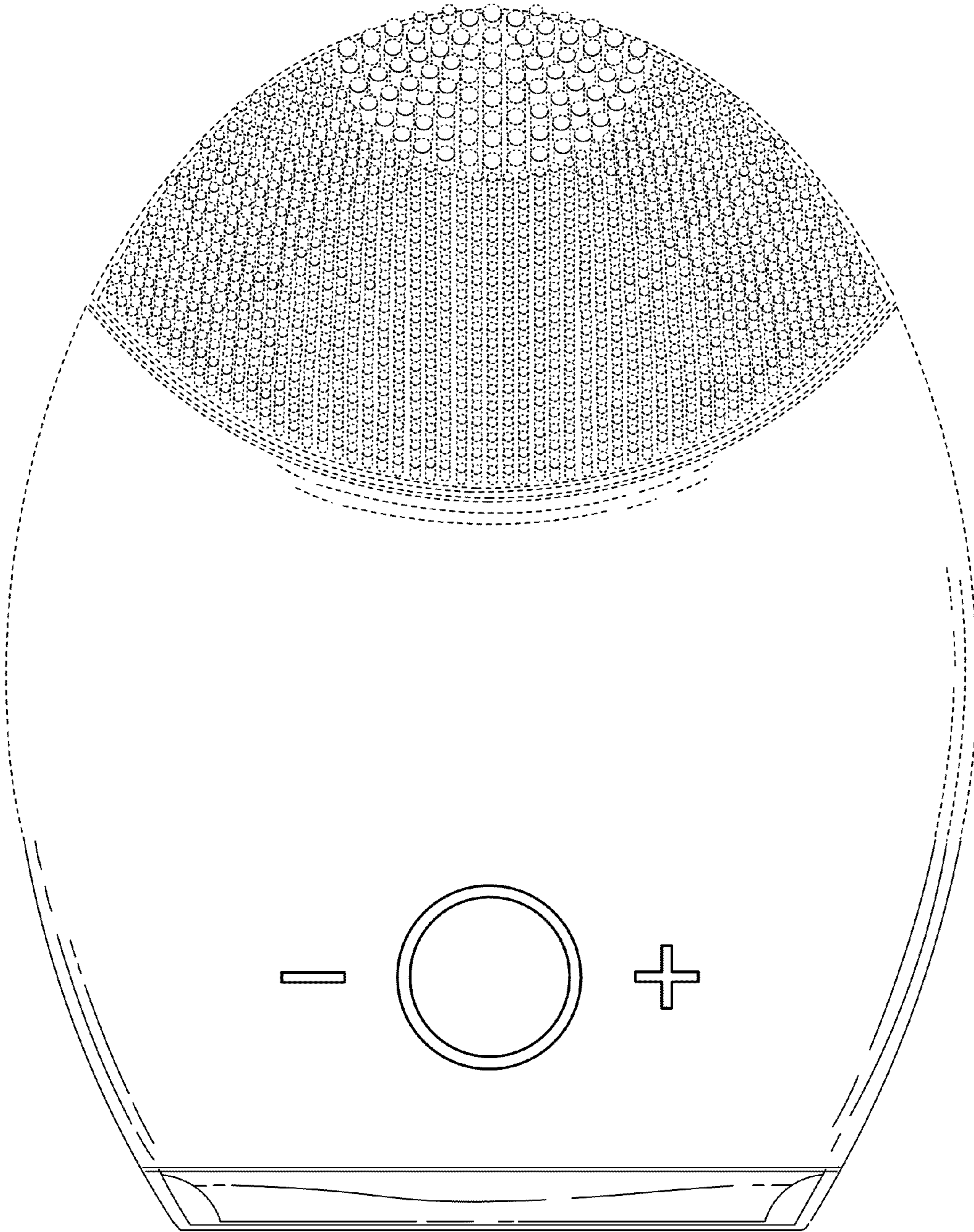

FIG. 41

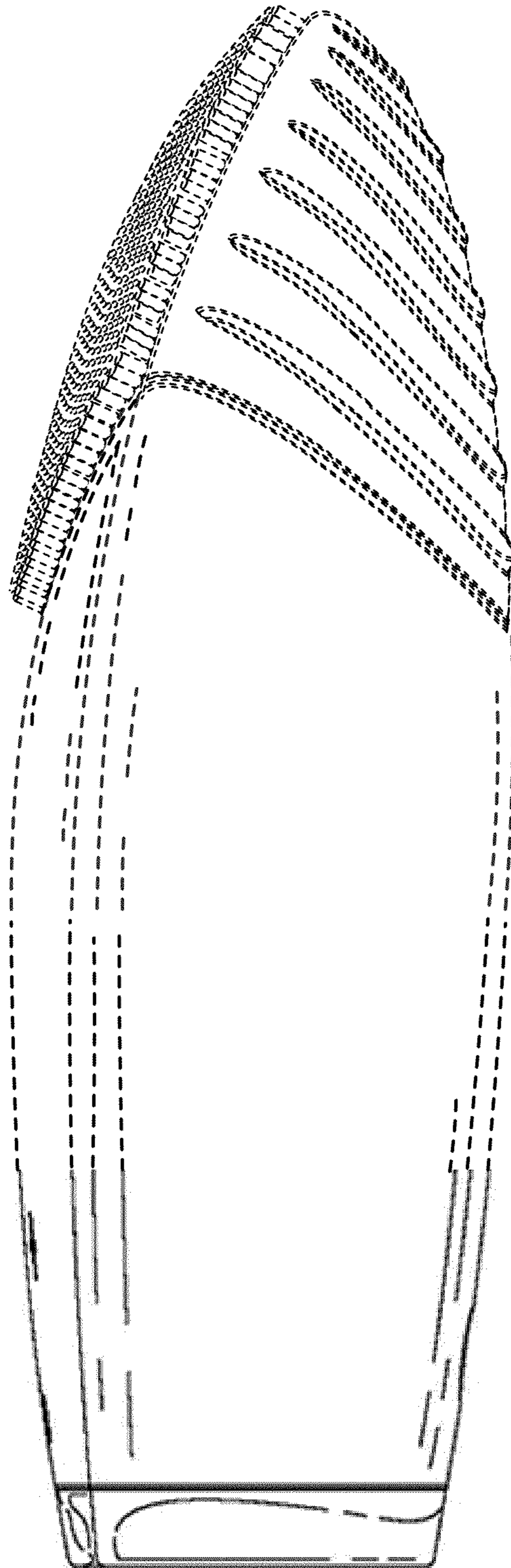

FIG. 42

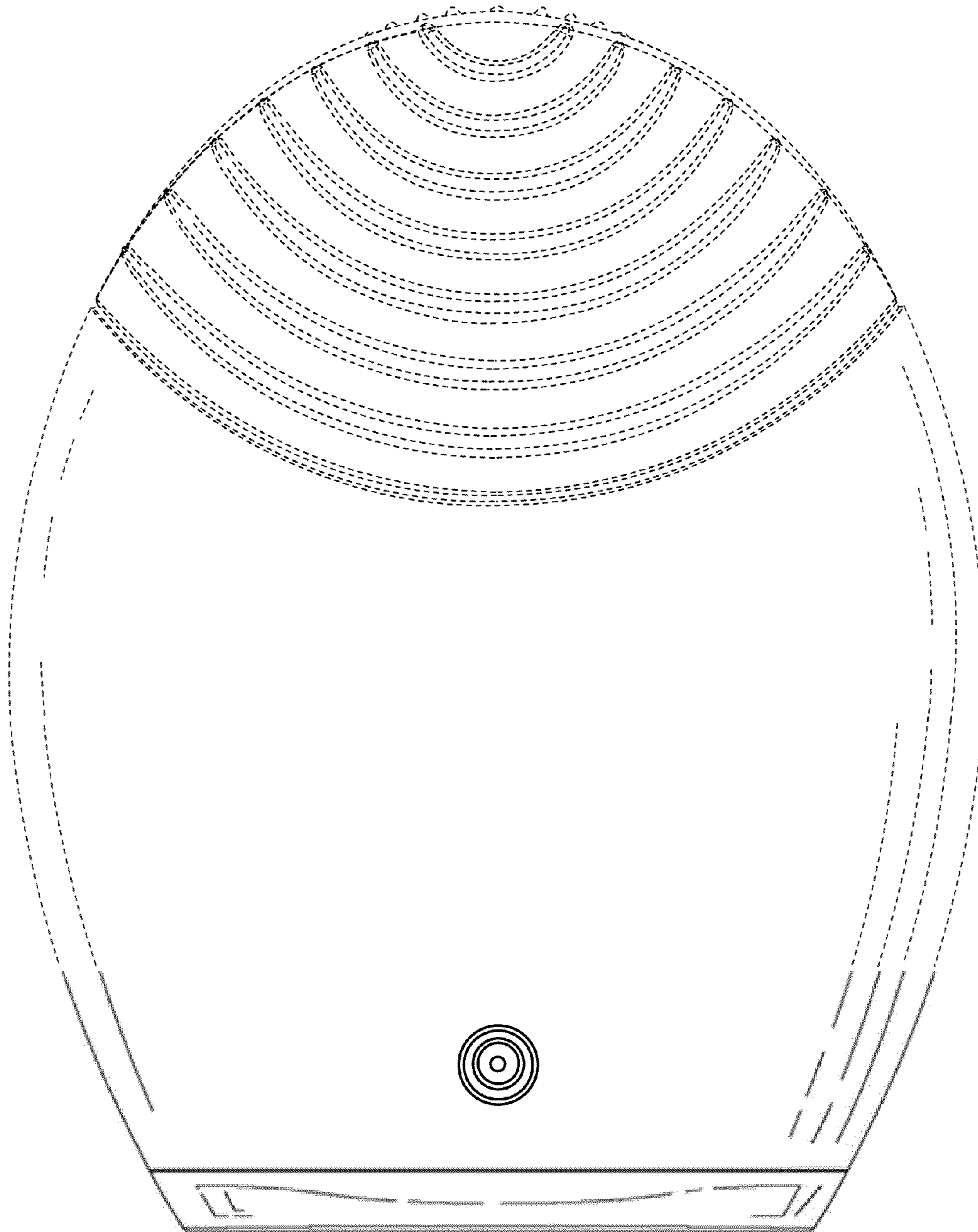

FIG. 43

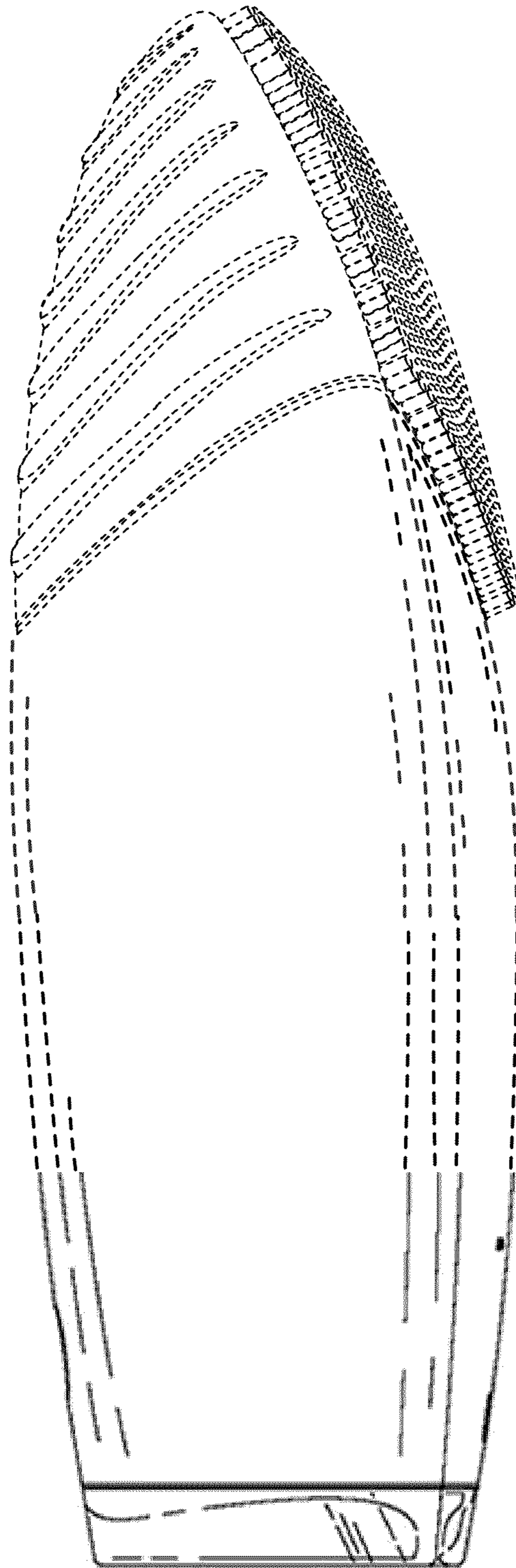

FIG. 44

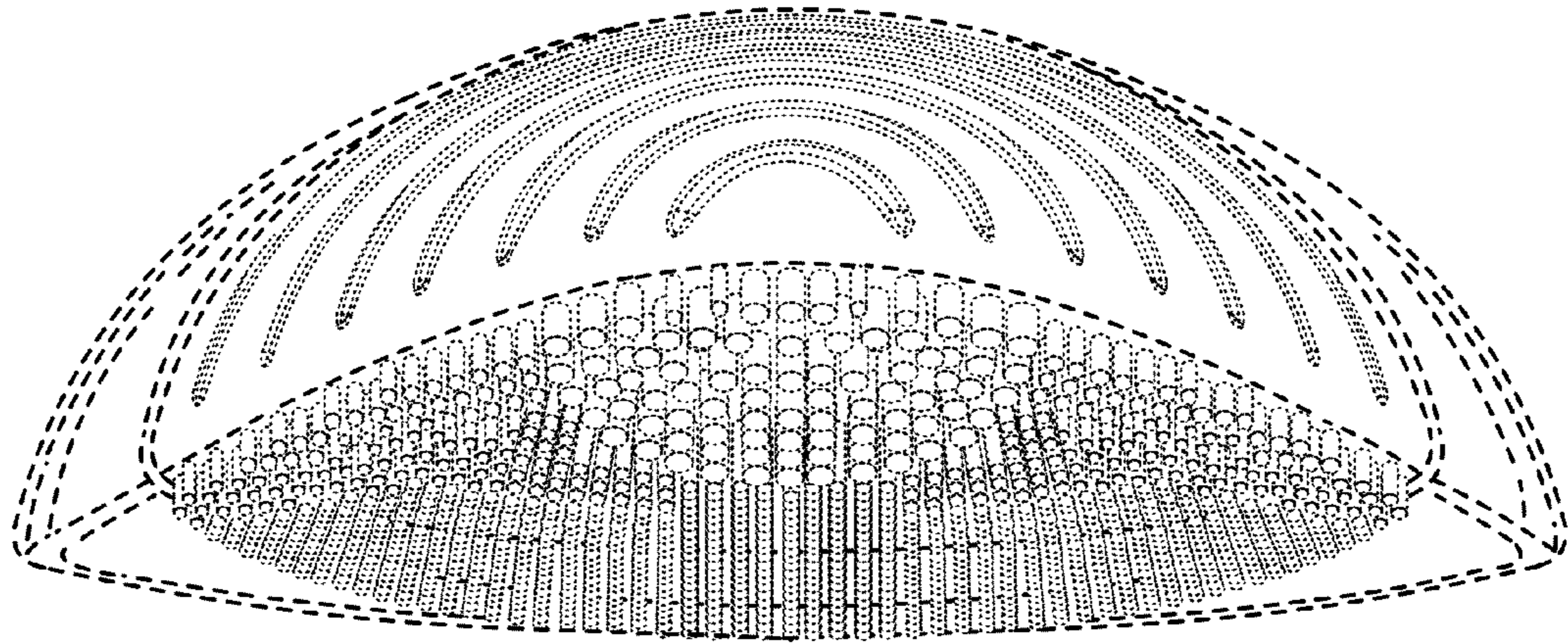

FIG. 45

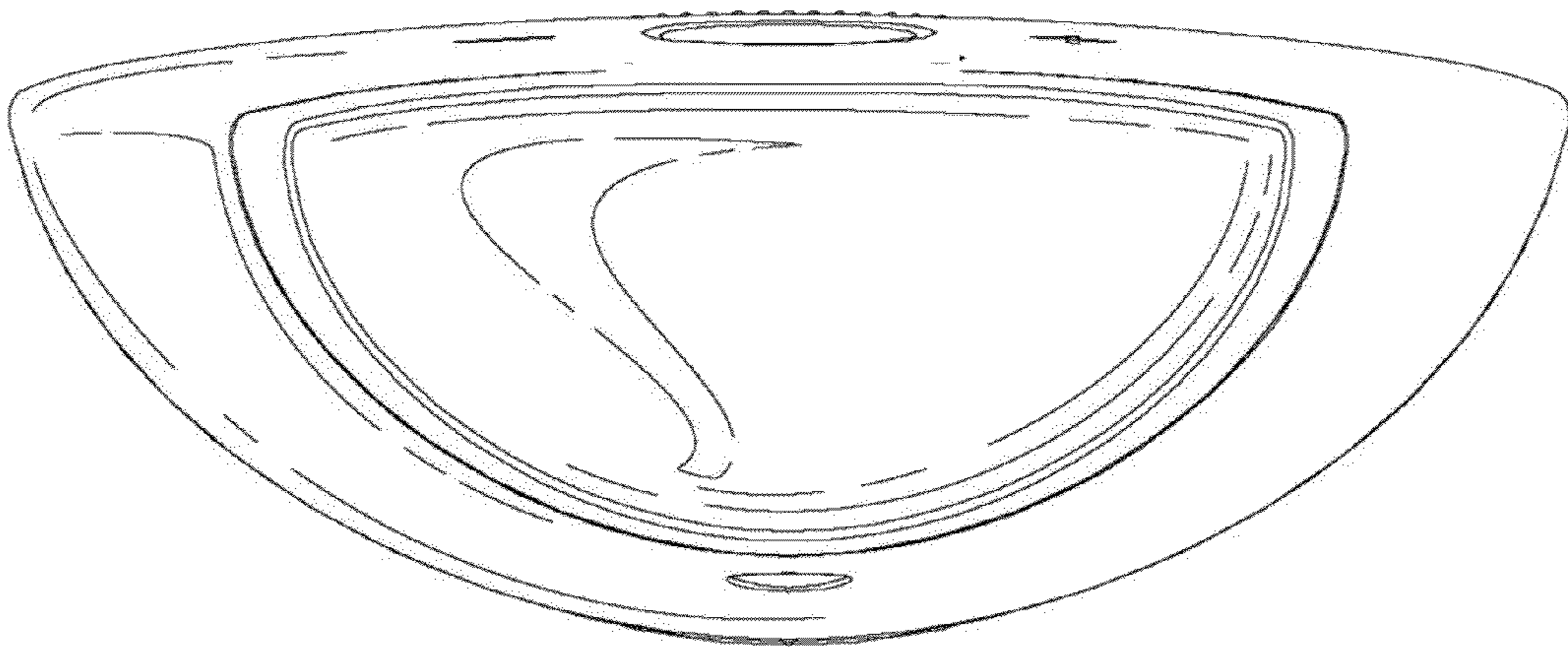

FIG. 46

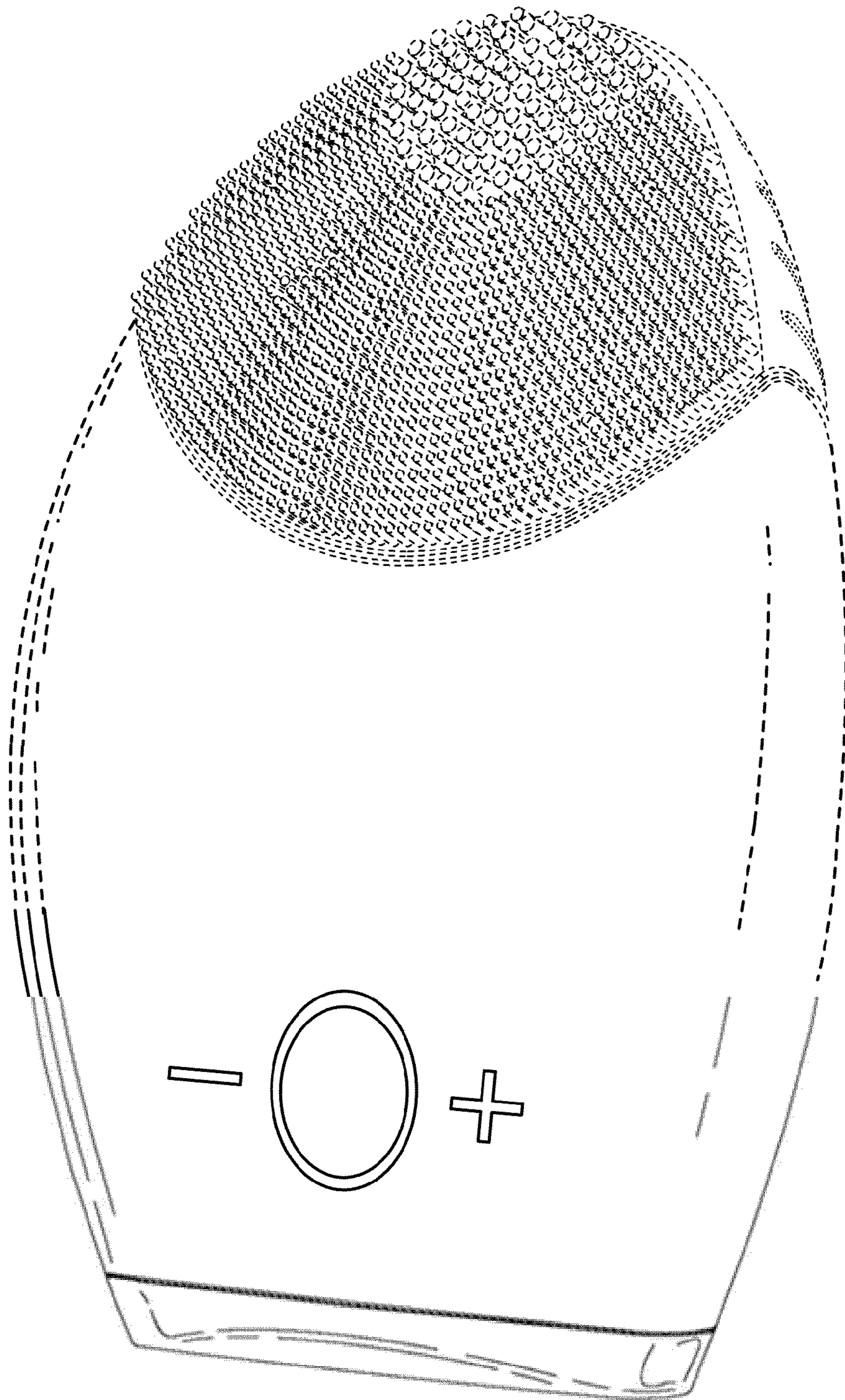

FIG. 47

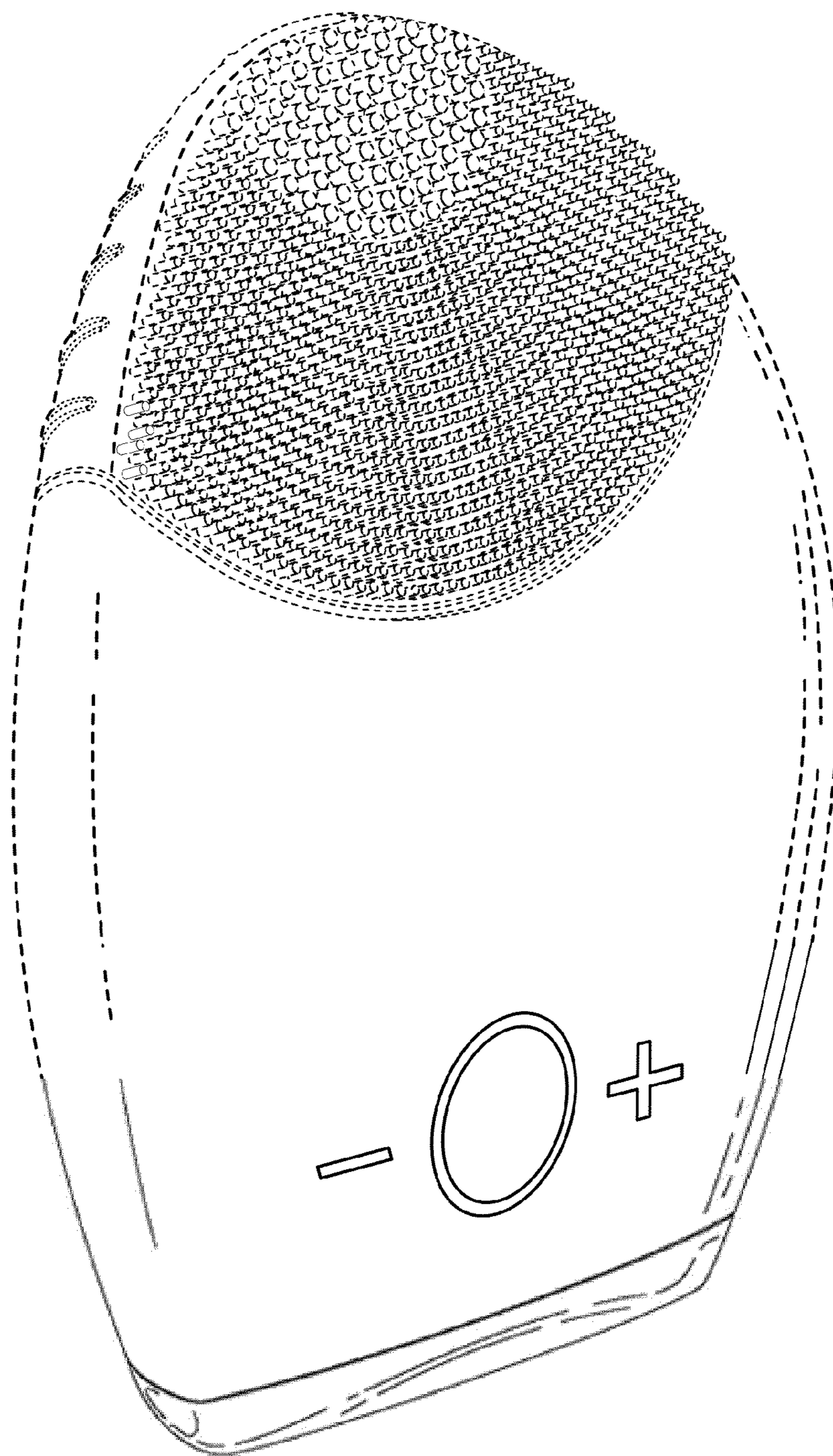

FIG. 48

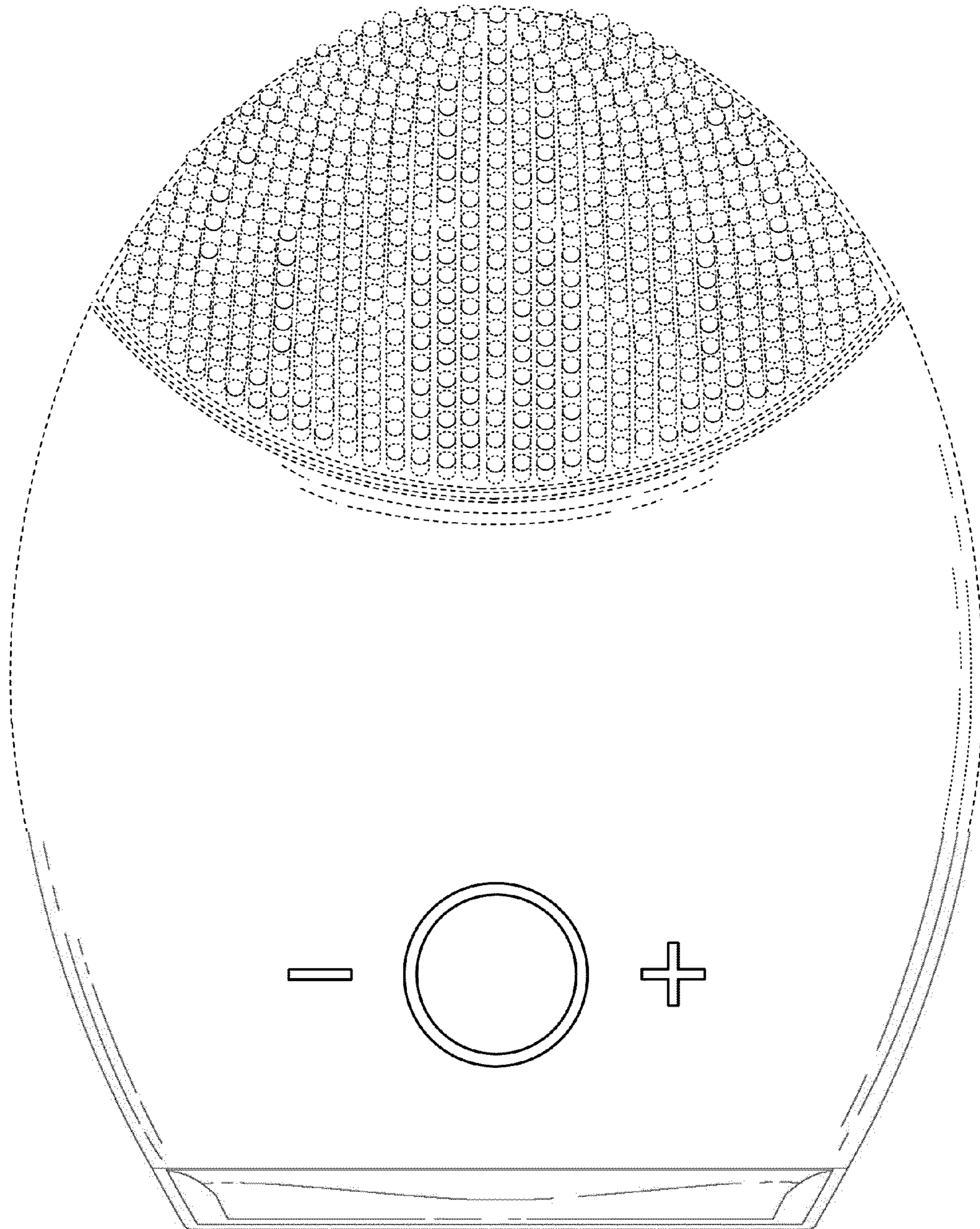

FIG. 49

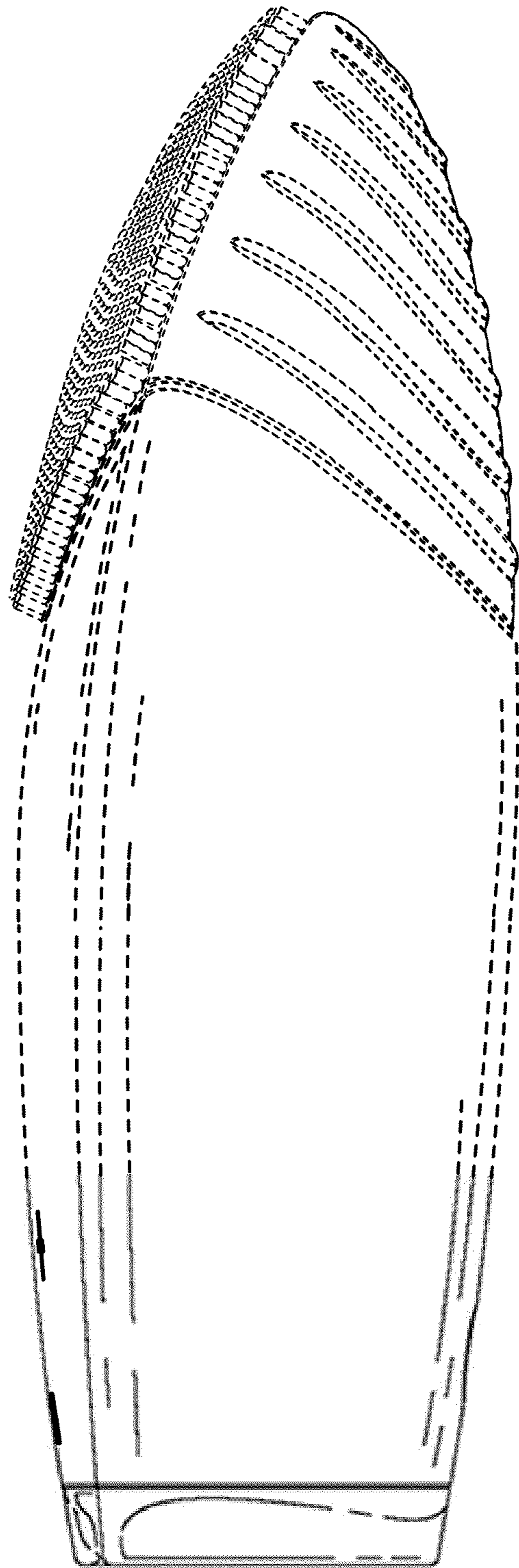

FIG. 50

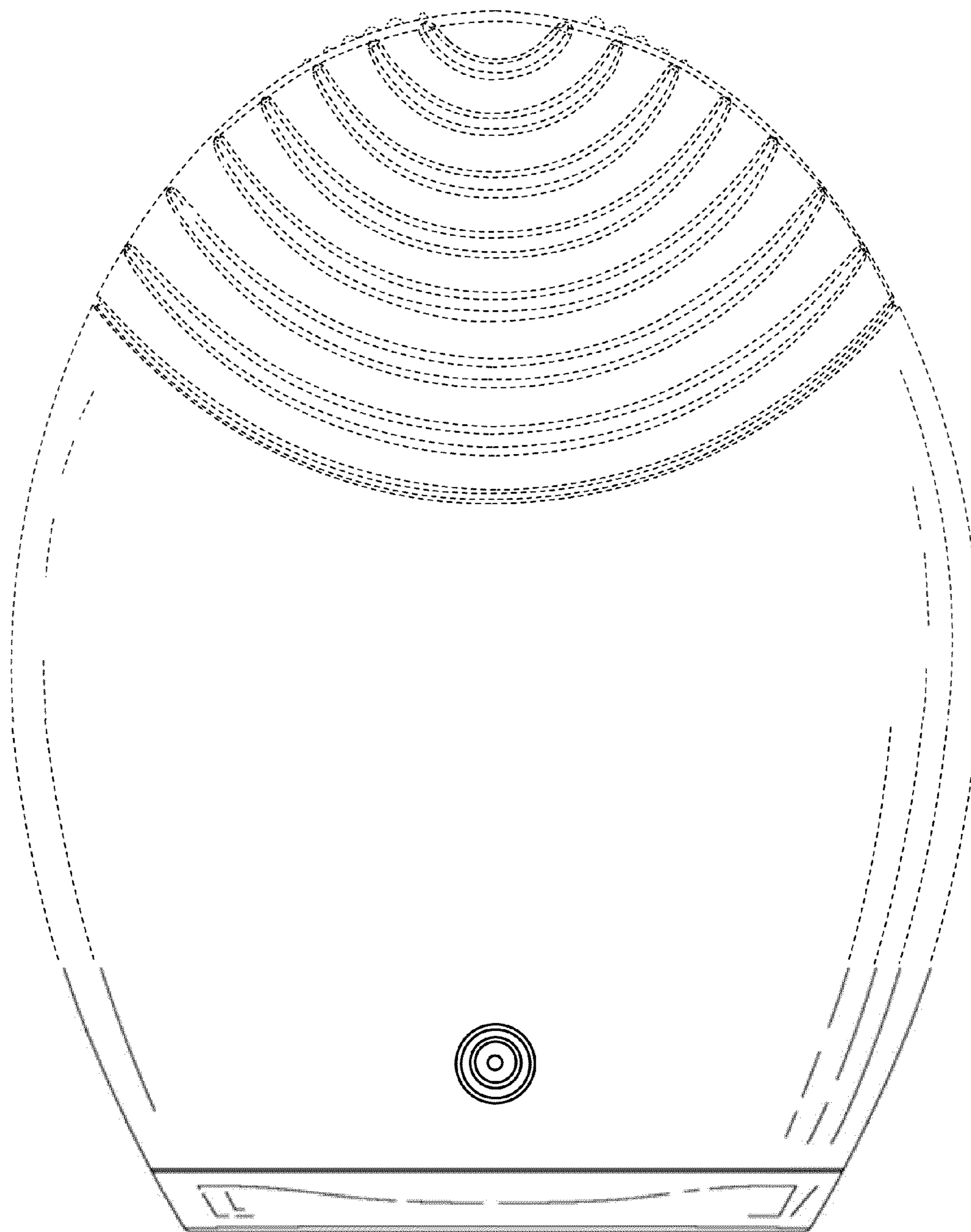

FIG. 51

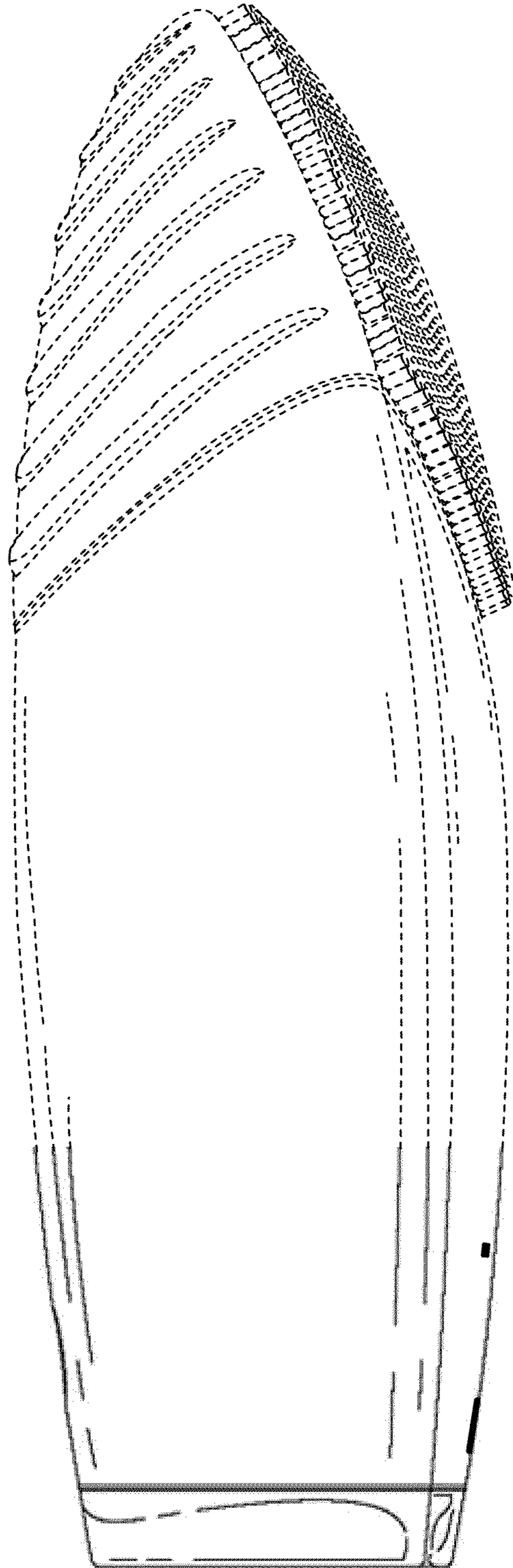

FIG. 52

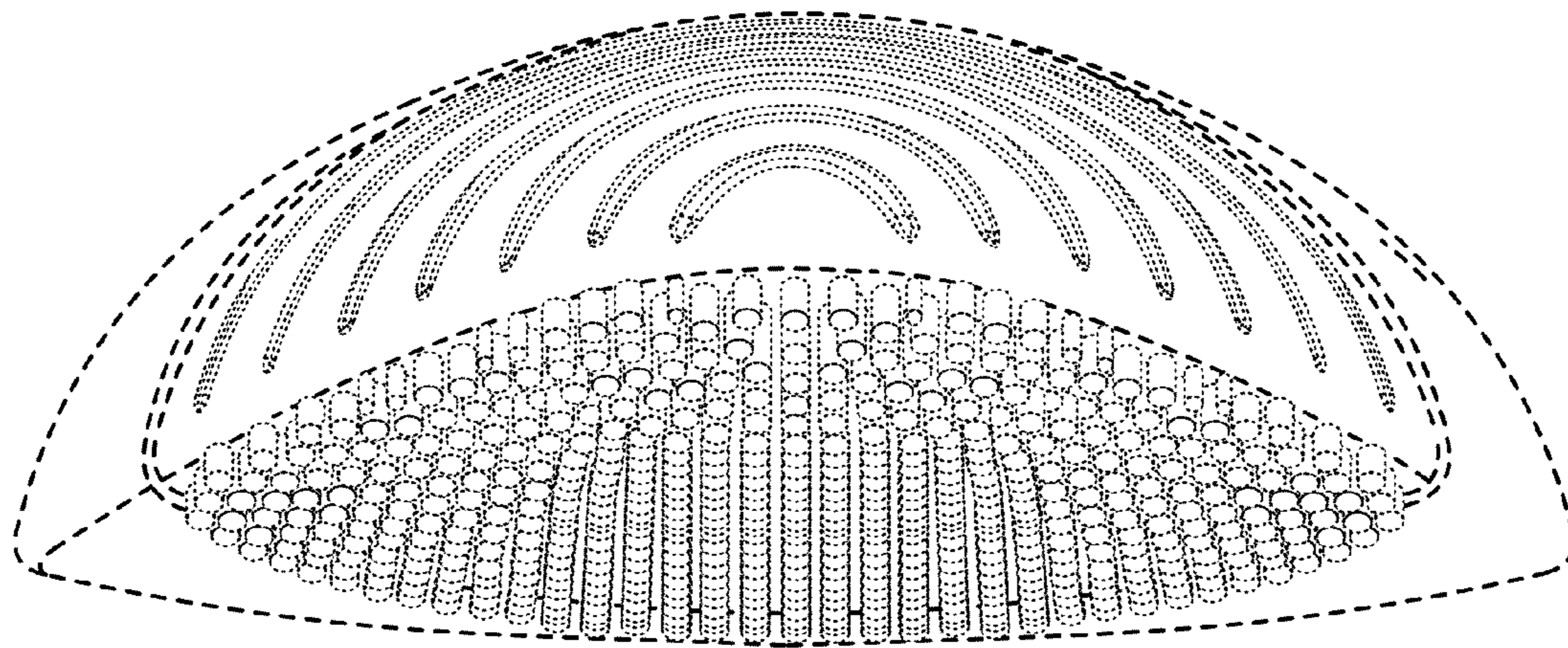

FIG. 53

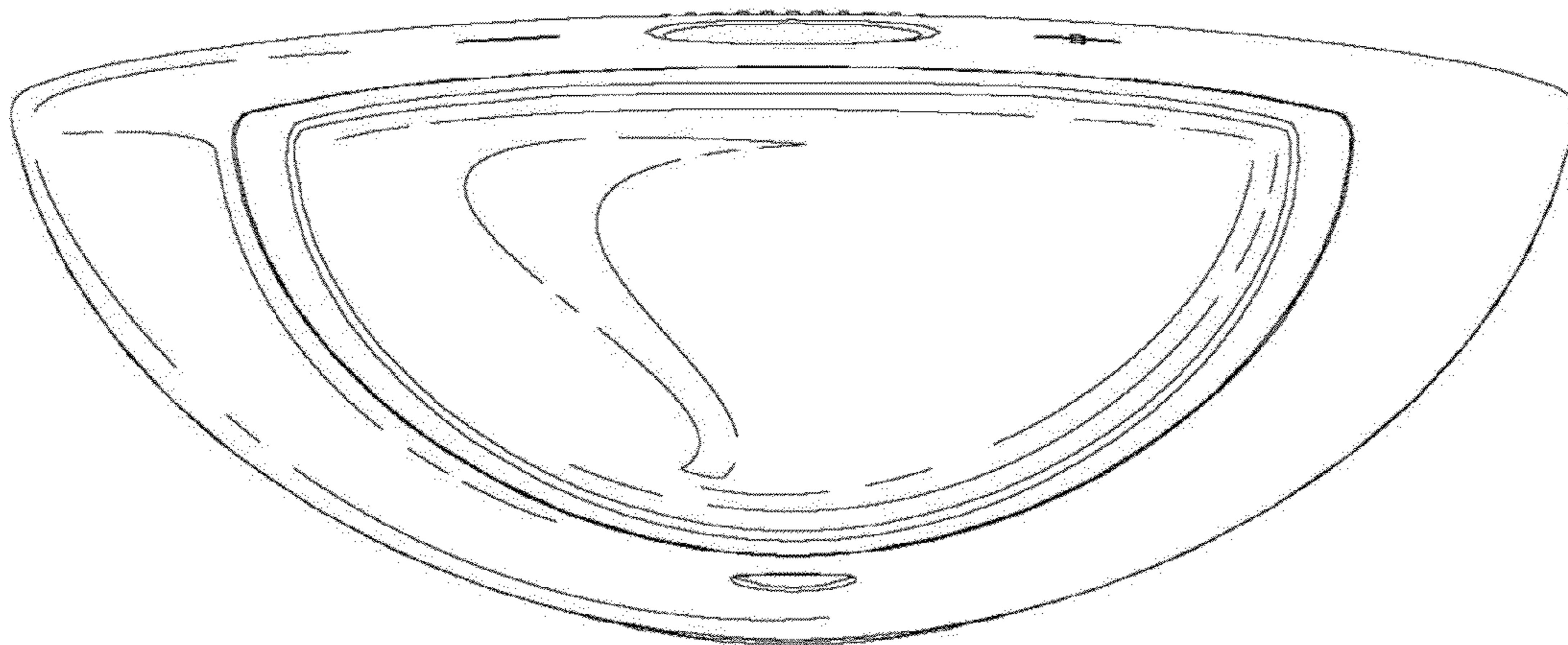

FIG. 54

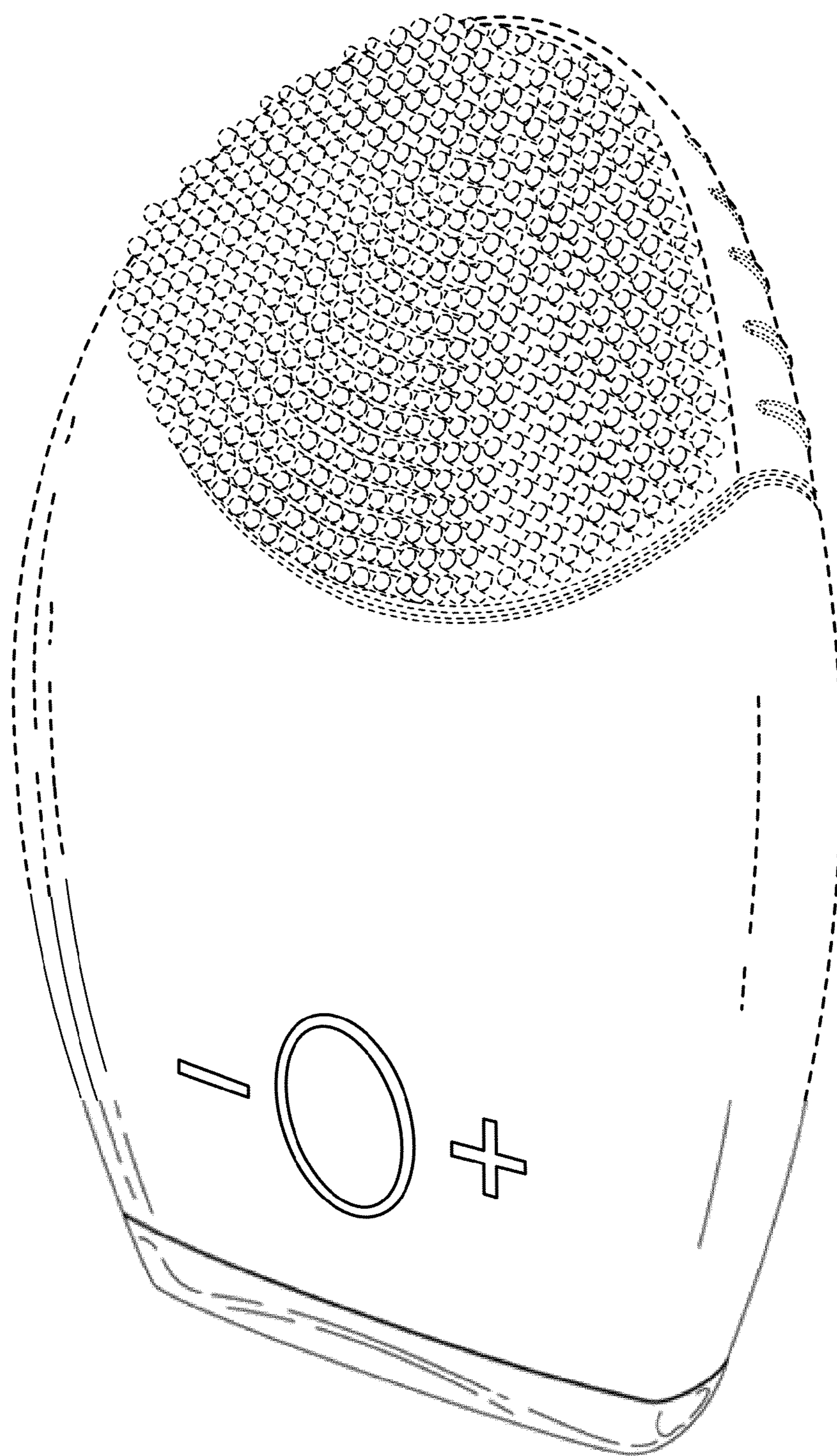

FIG. 55

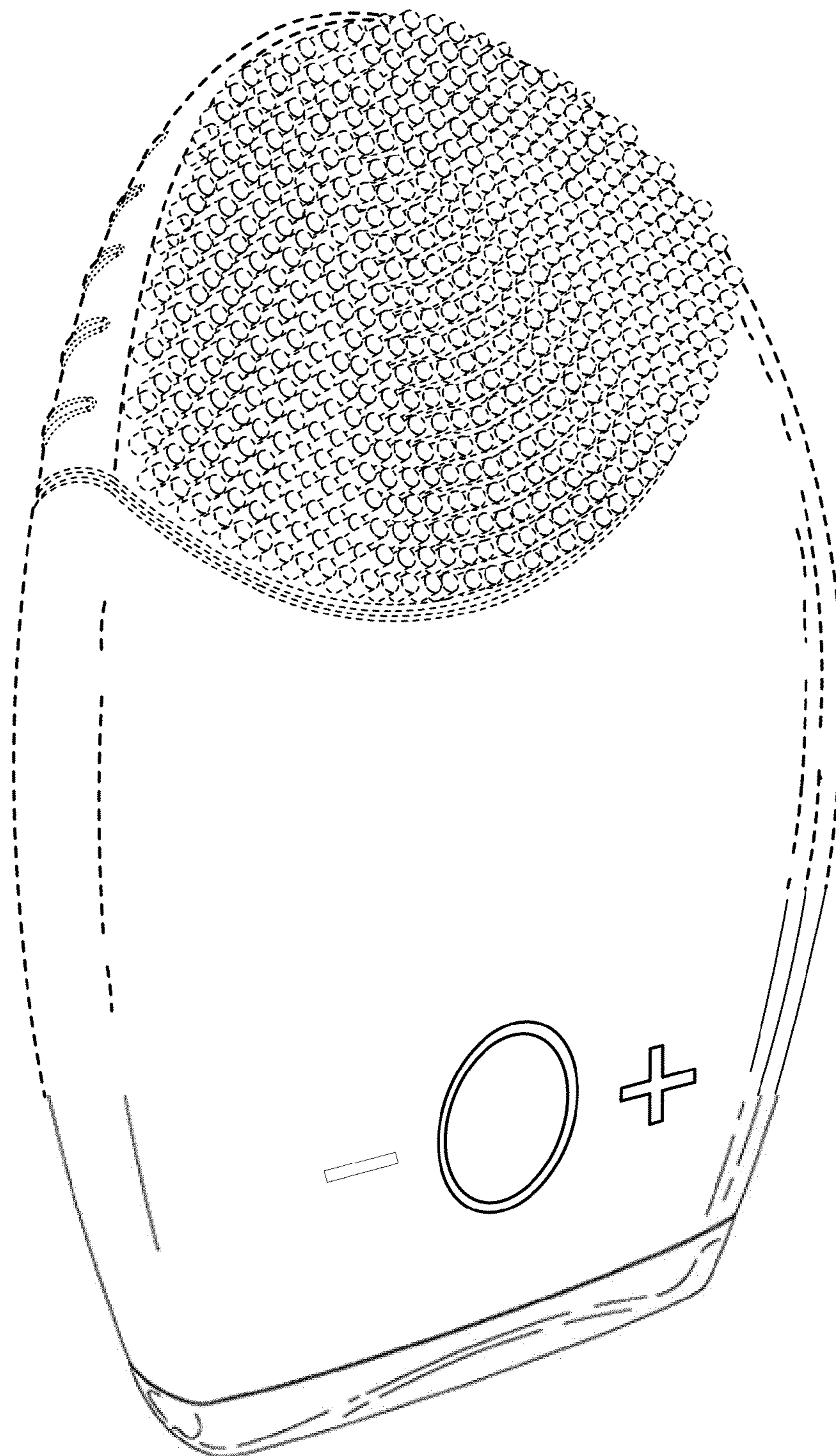

FIG. 56

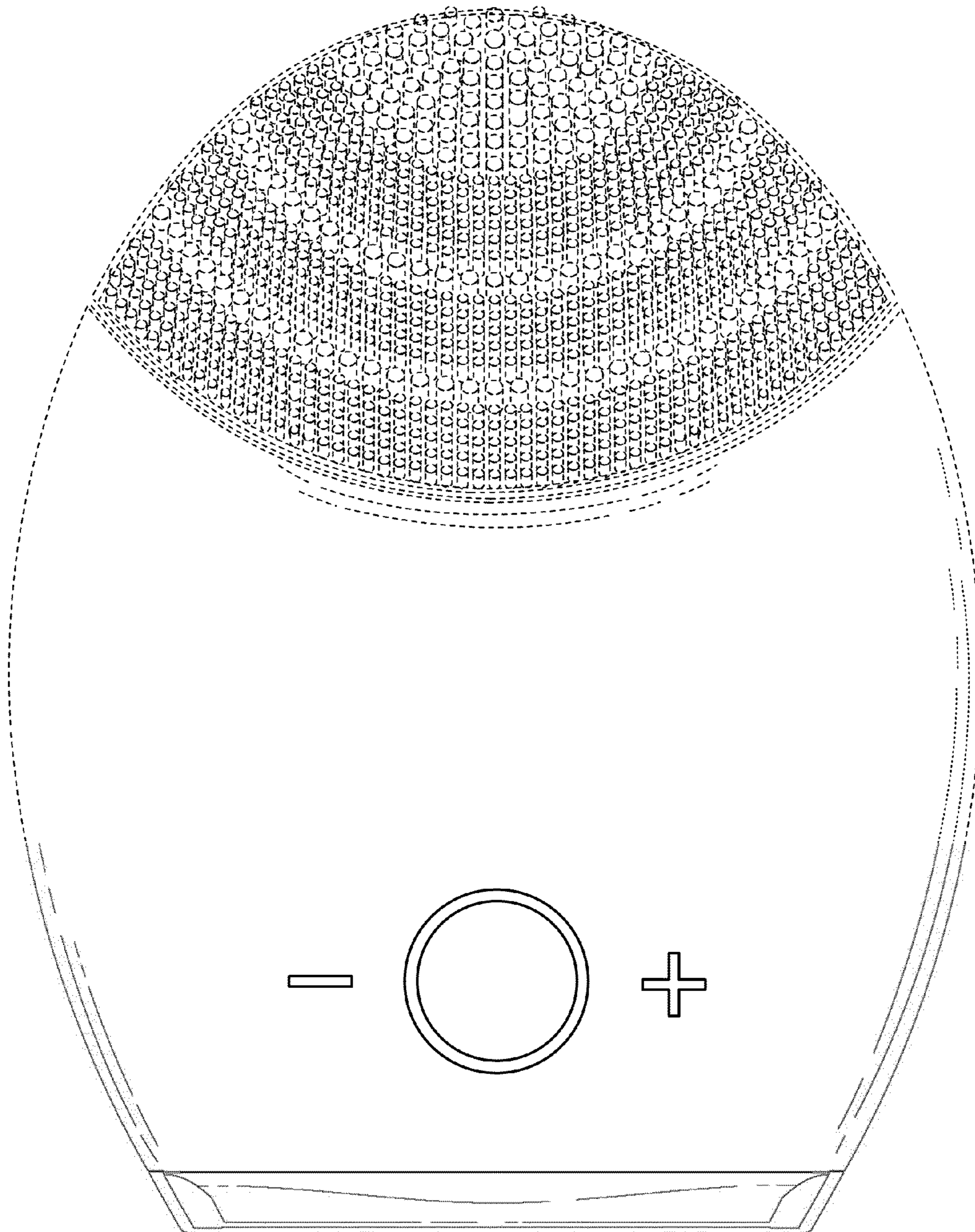

FIG. 57

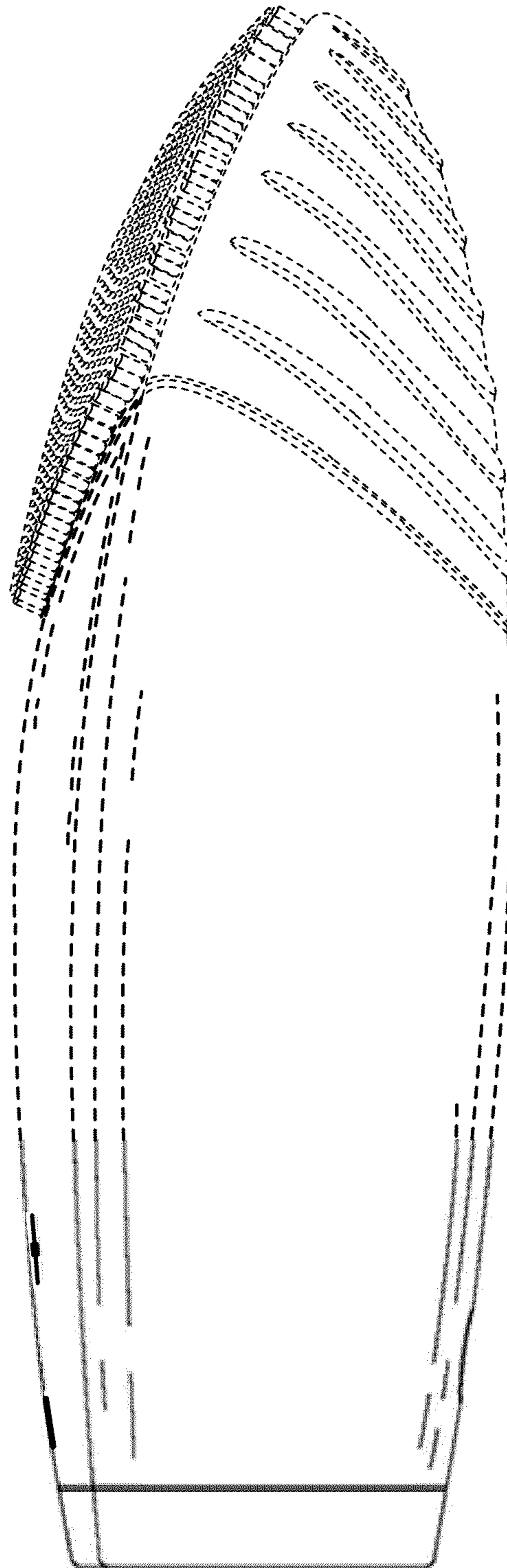

FIG. 58

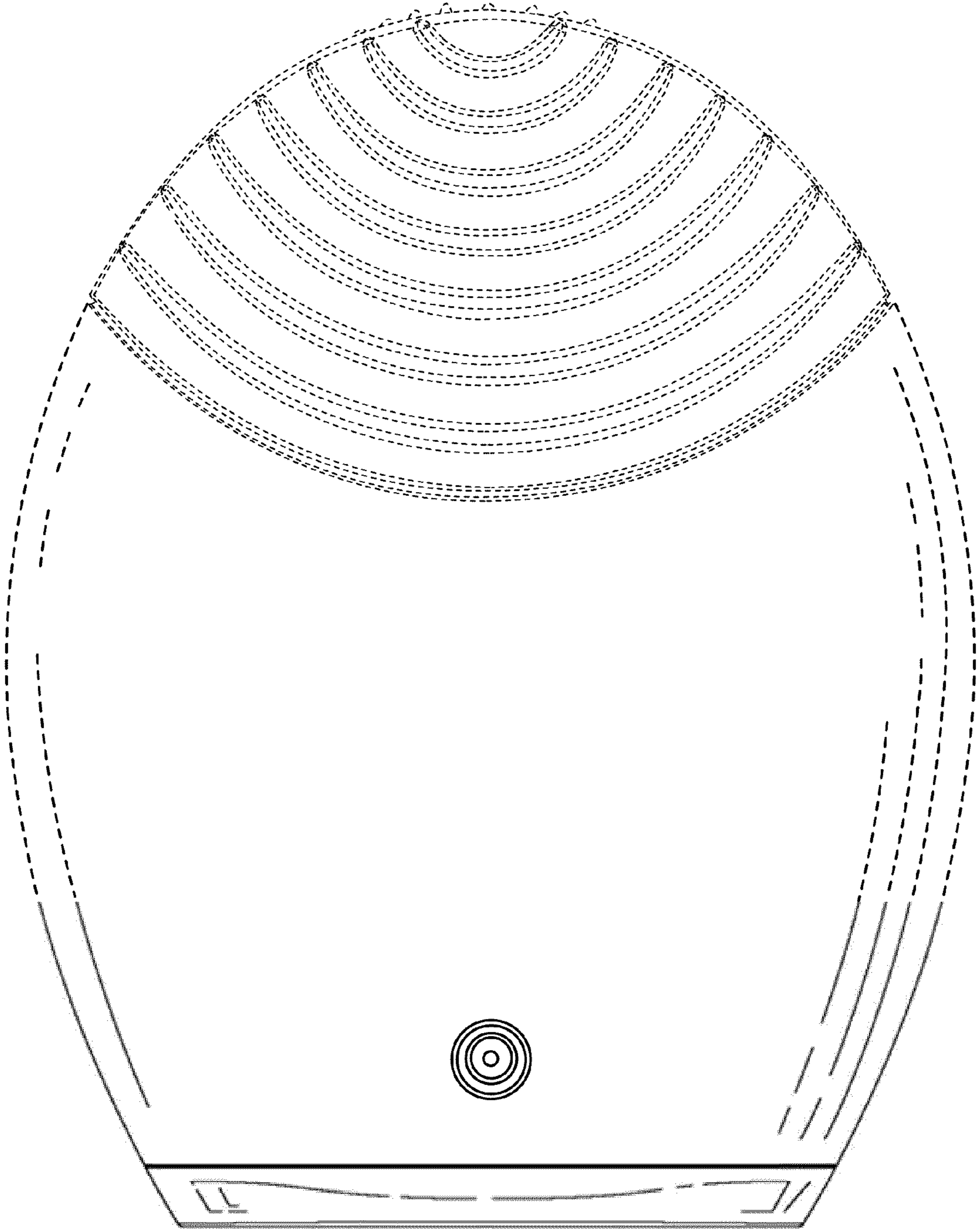

FIG. 59

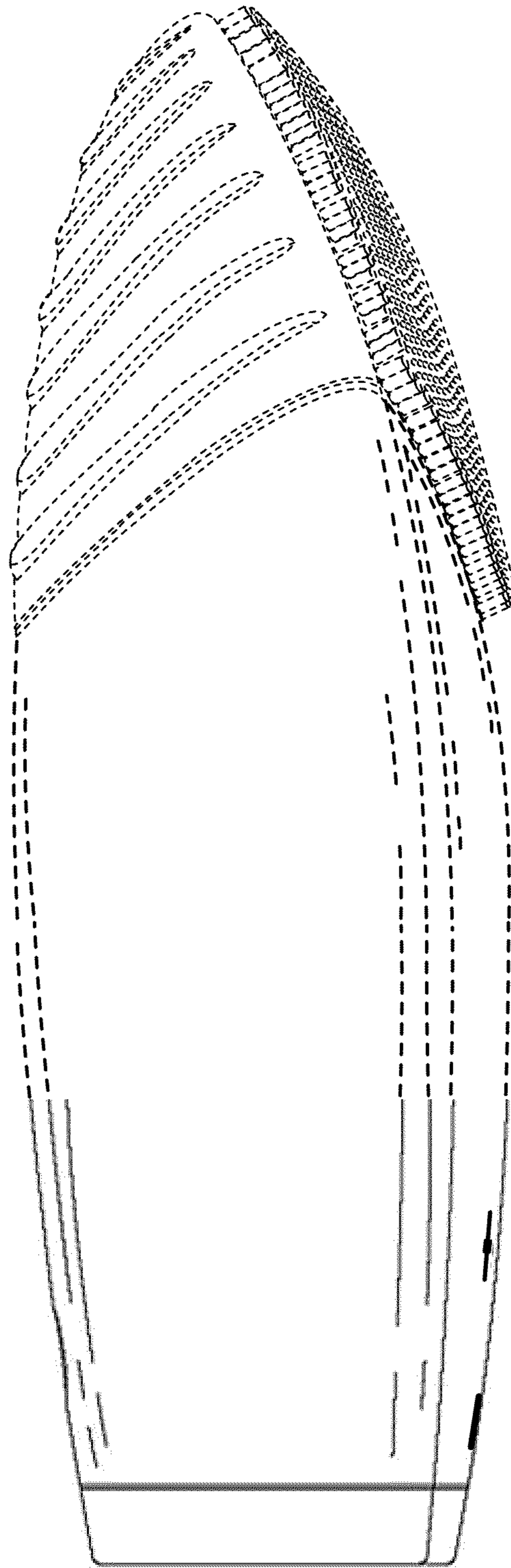

FIG. 60

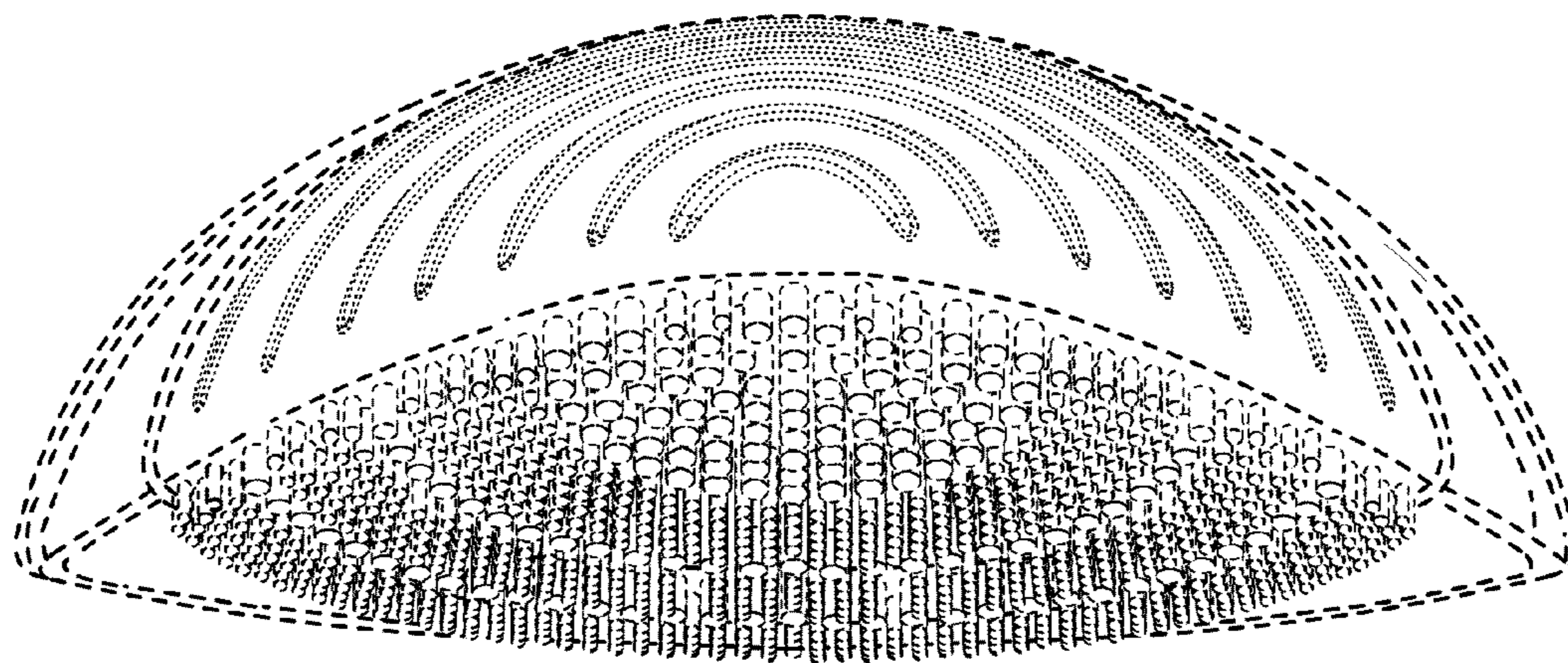

FIG. 61

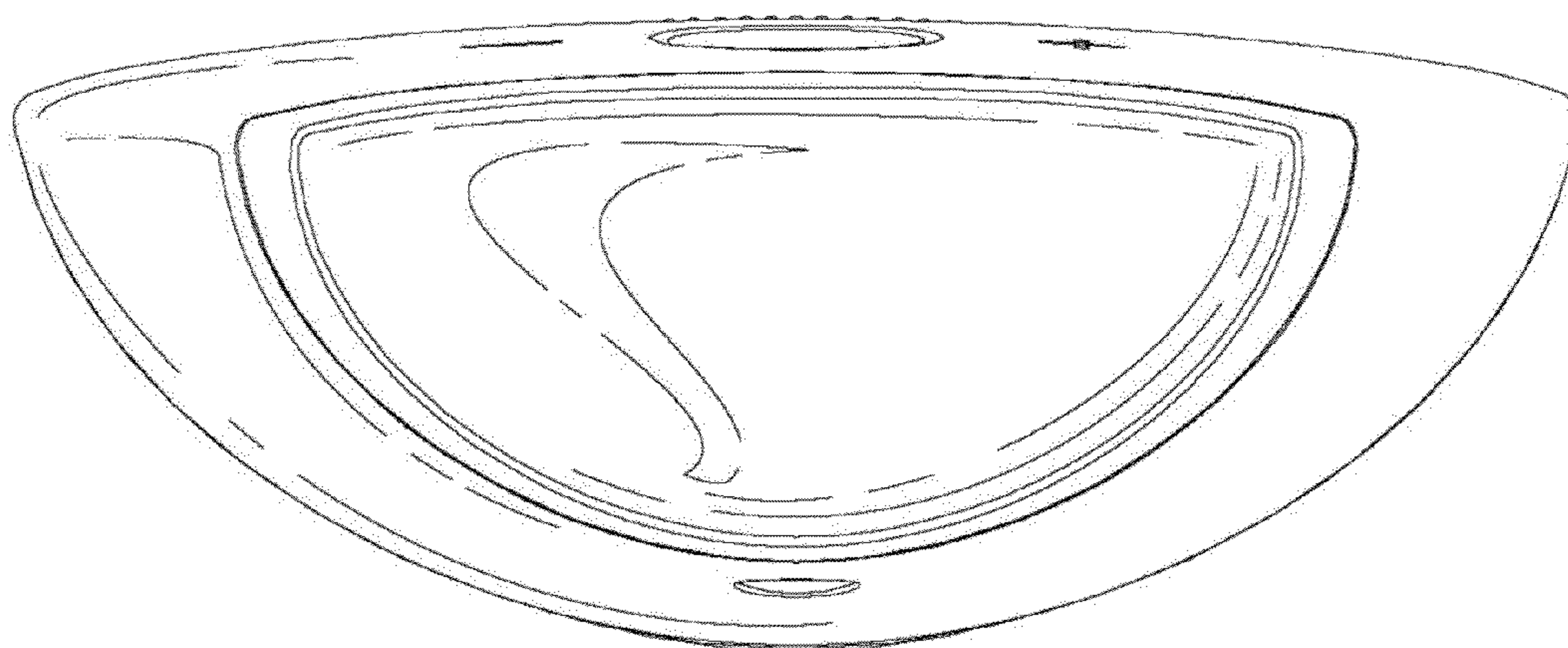

FIG. 62

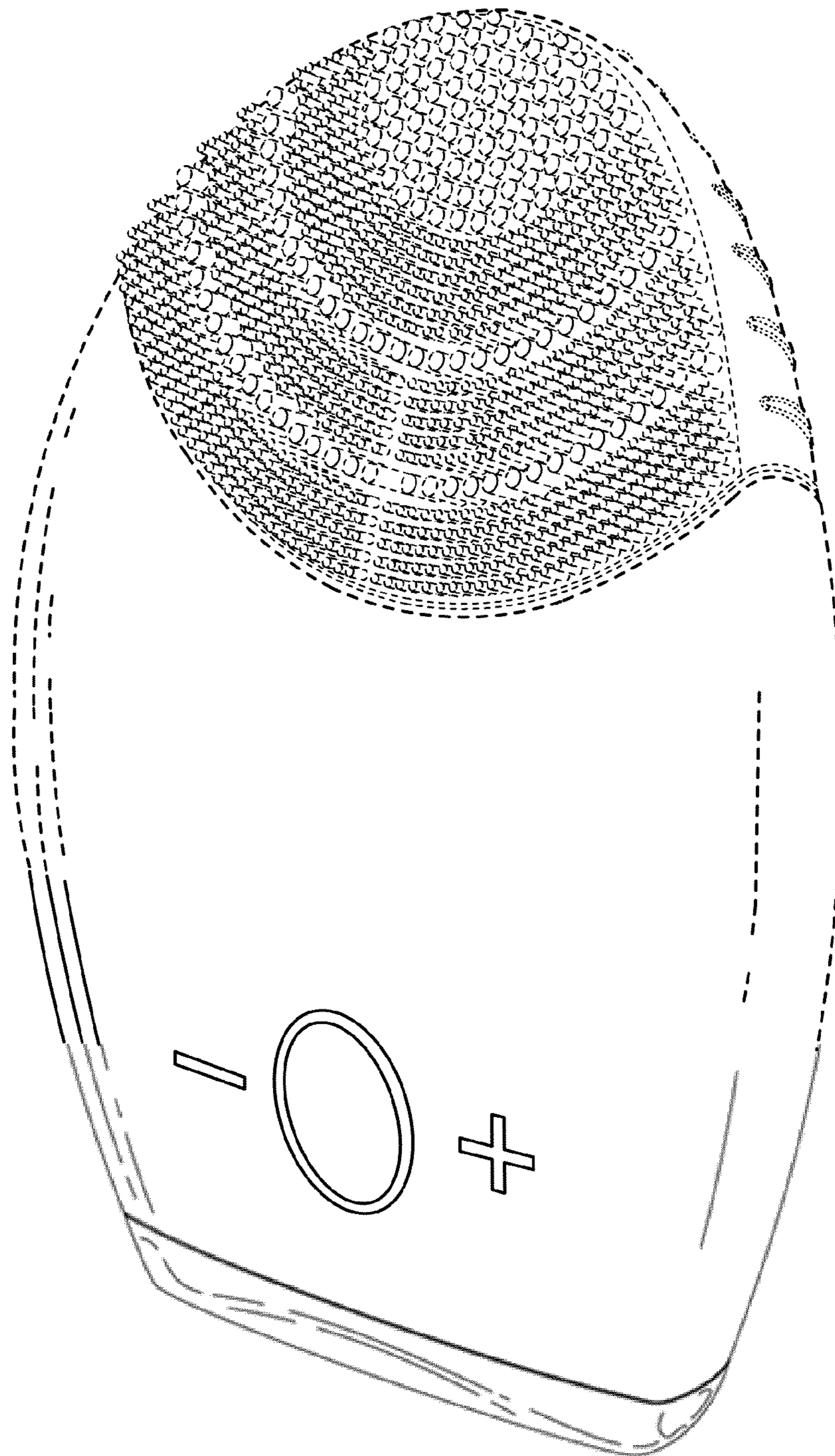

FIG. 63

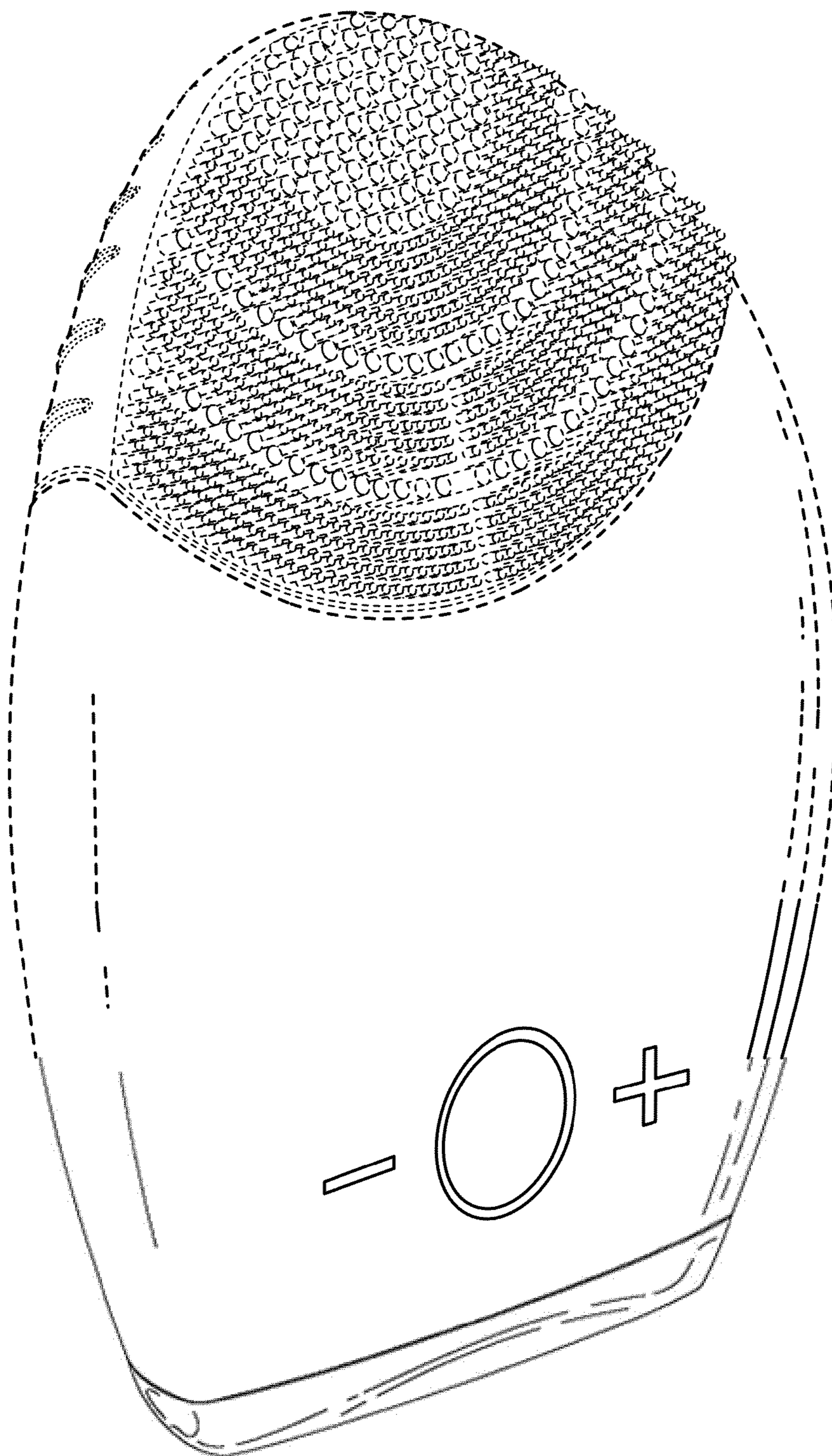

FIG. 64

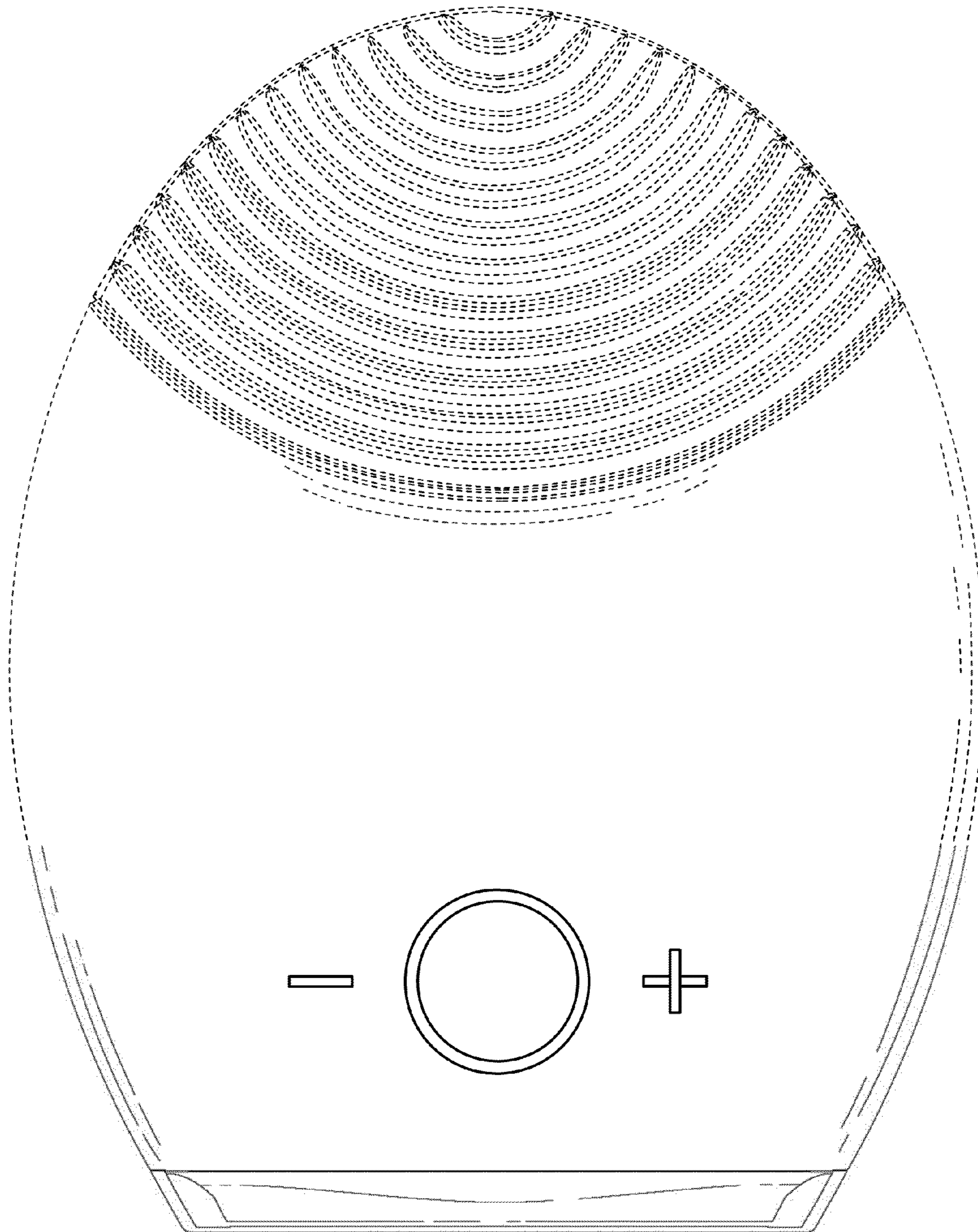

FIG. 65

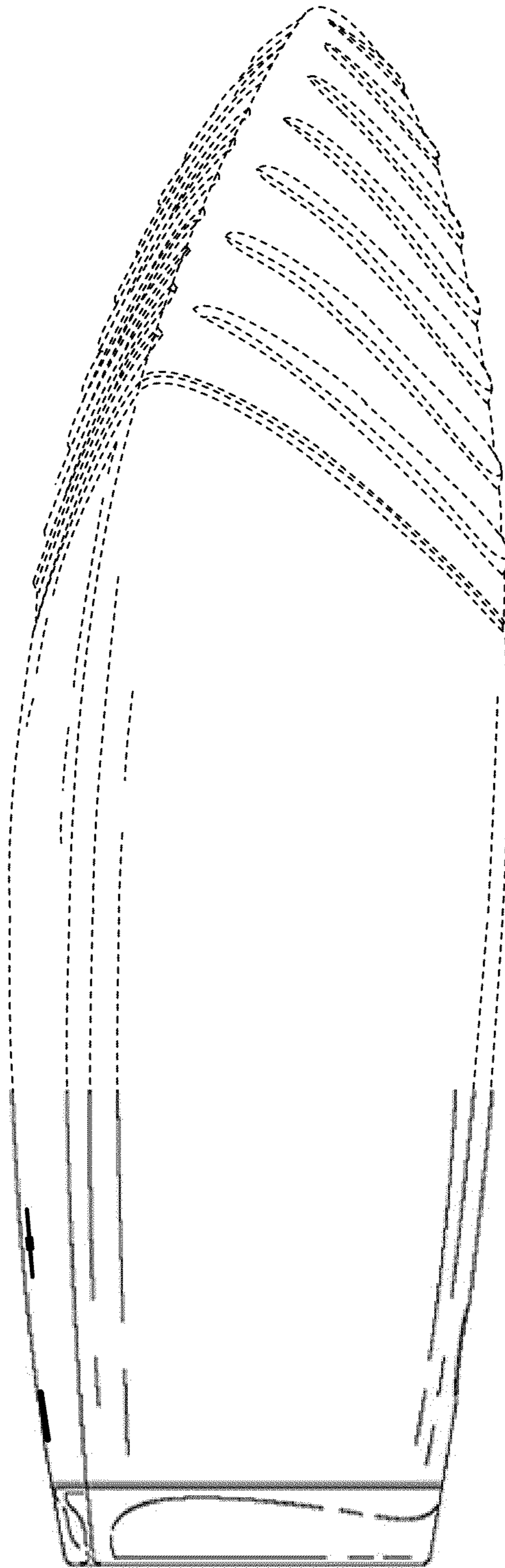

FIG. 66

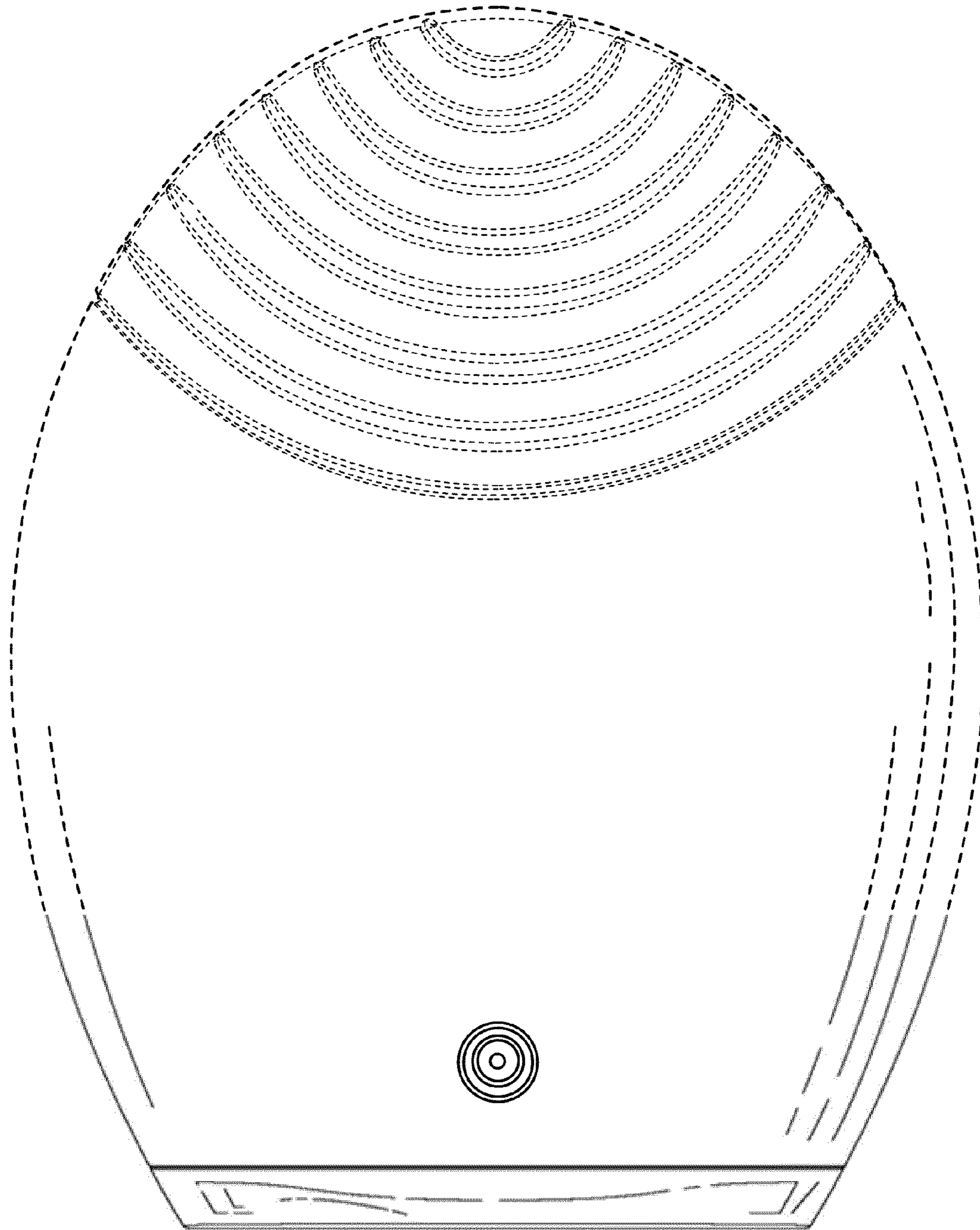

FIG. 67

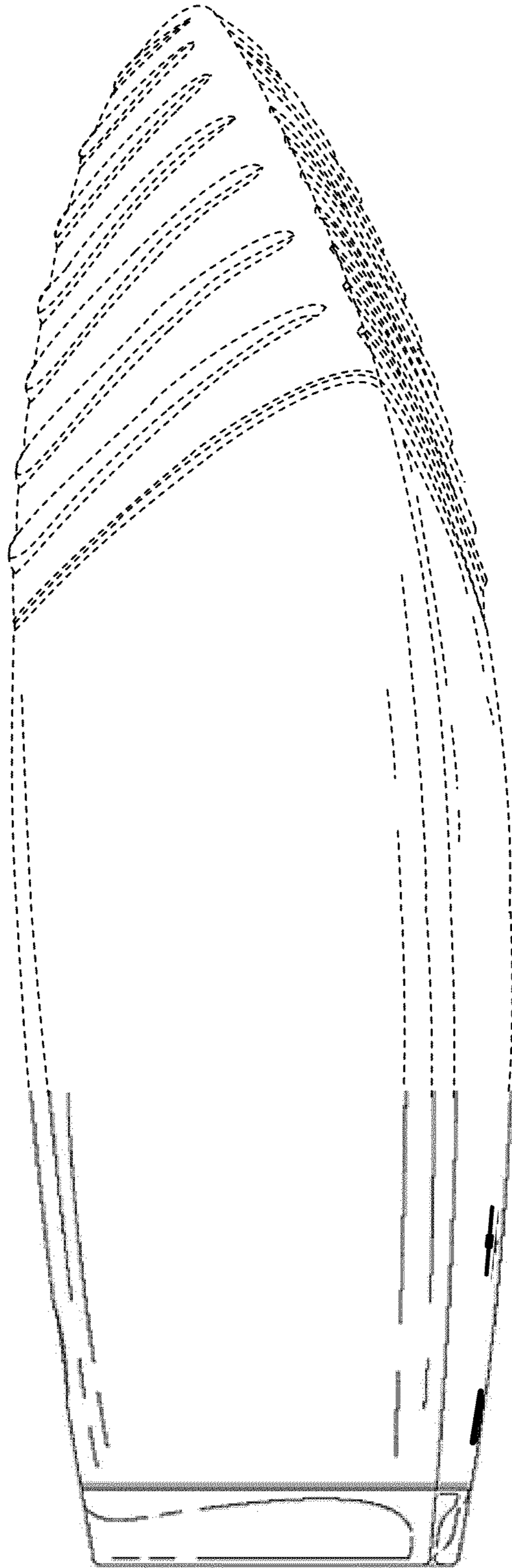

FIG. 68

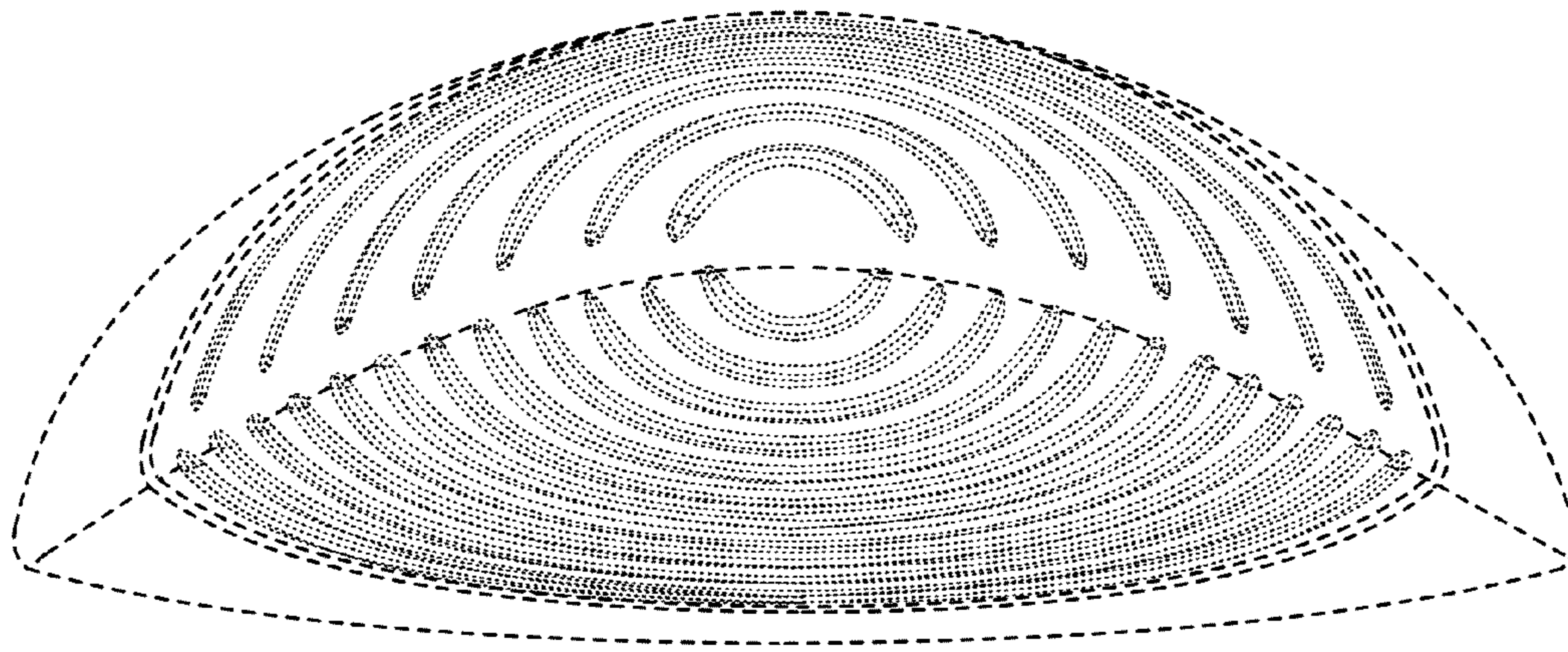

FIG. 69

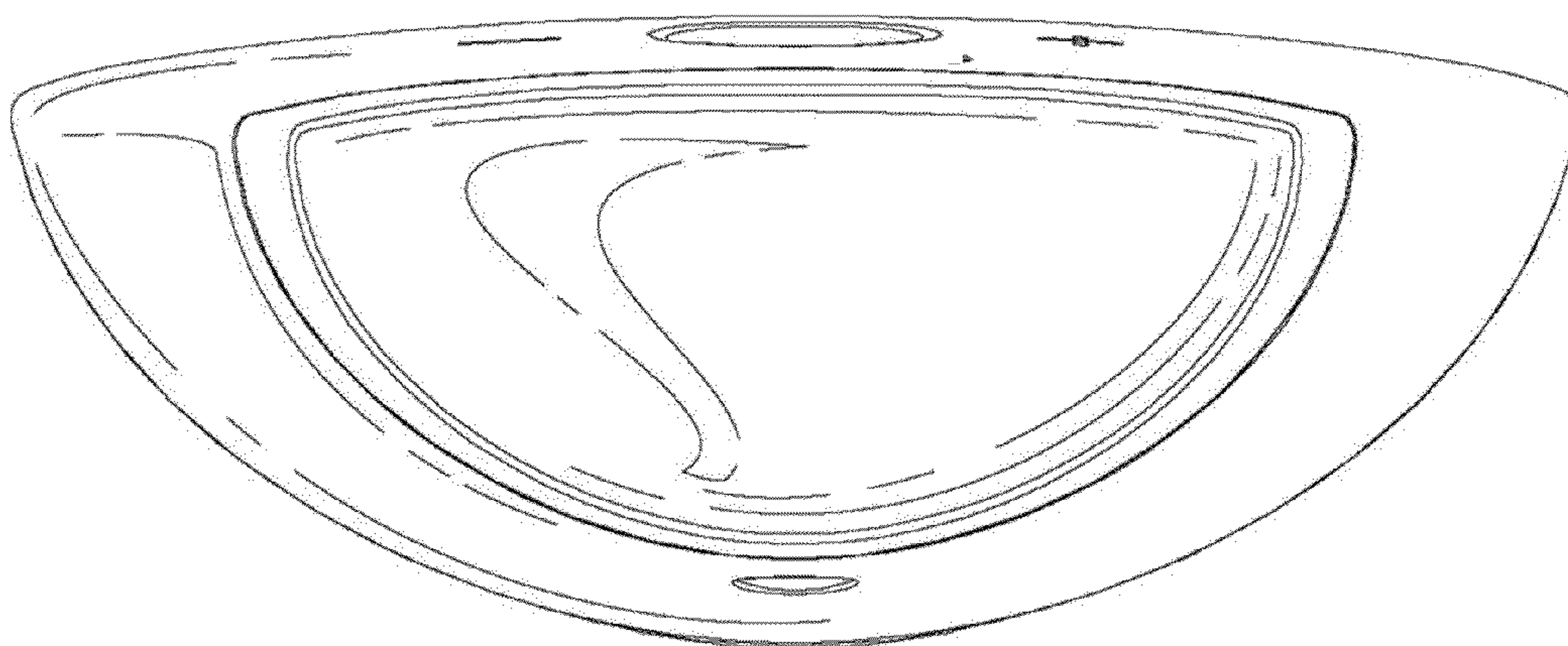

FIG. 70

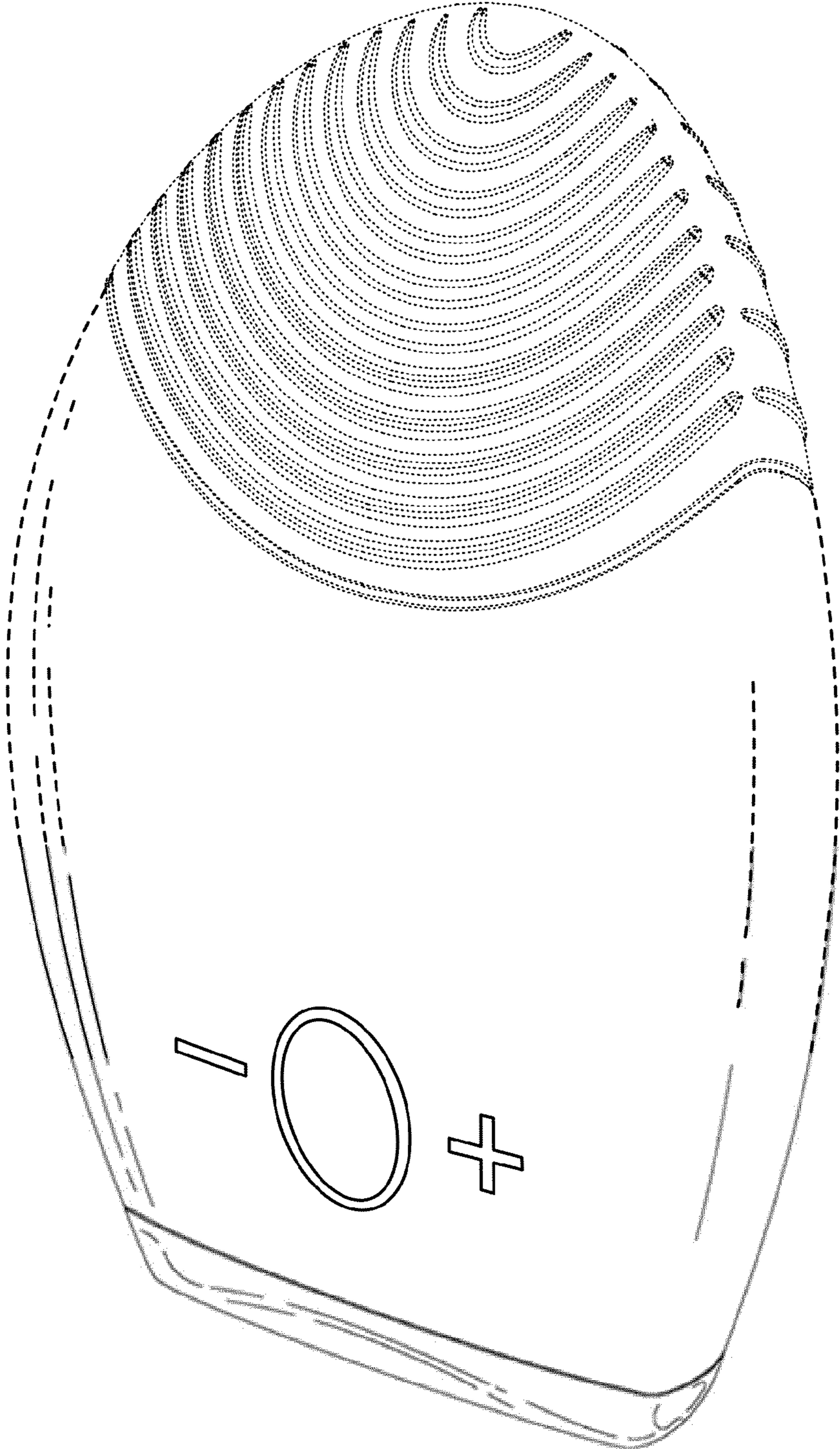

FIG. 71

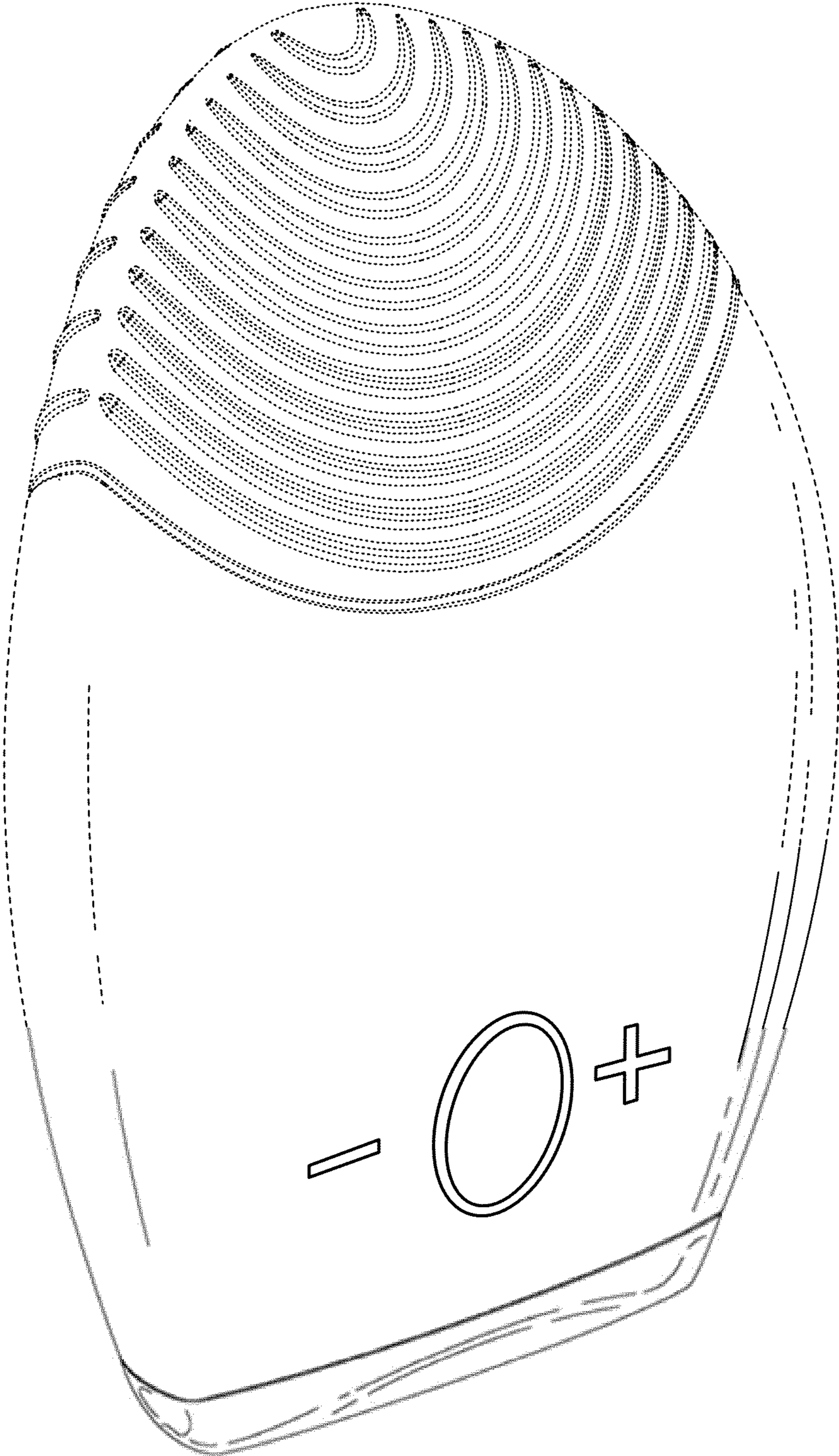

FIG. 72

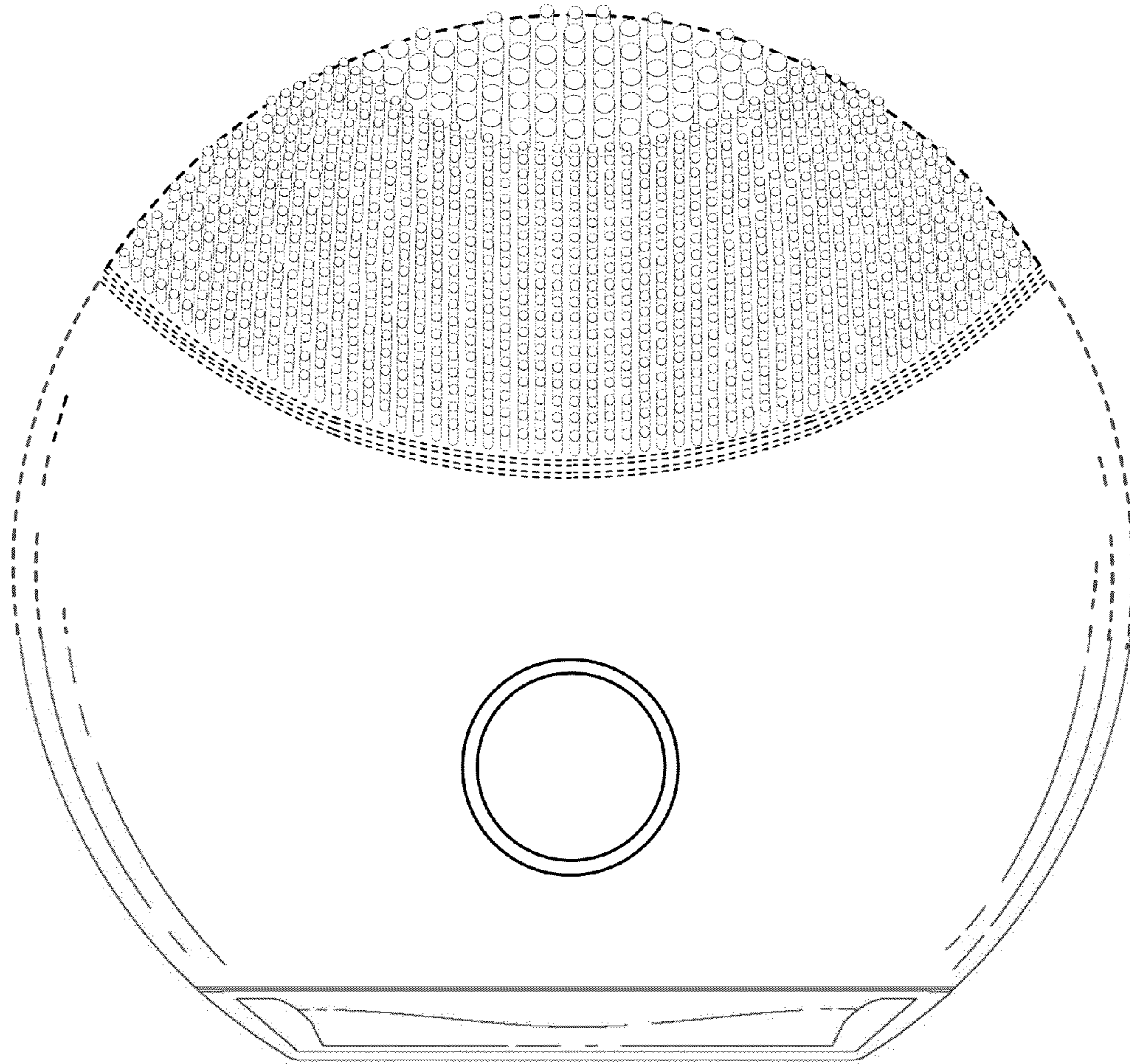

FIG. 73

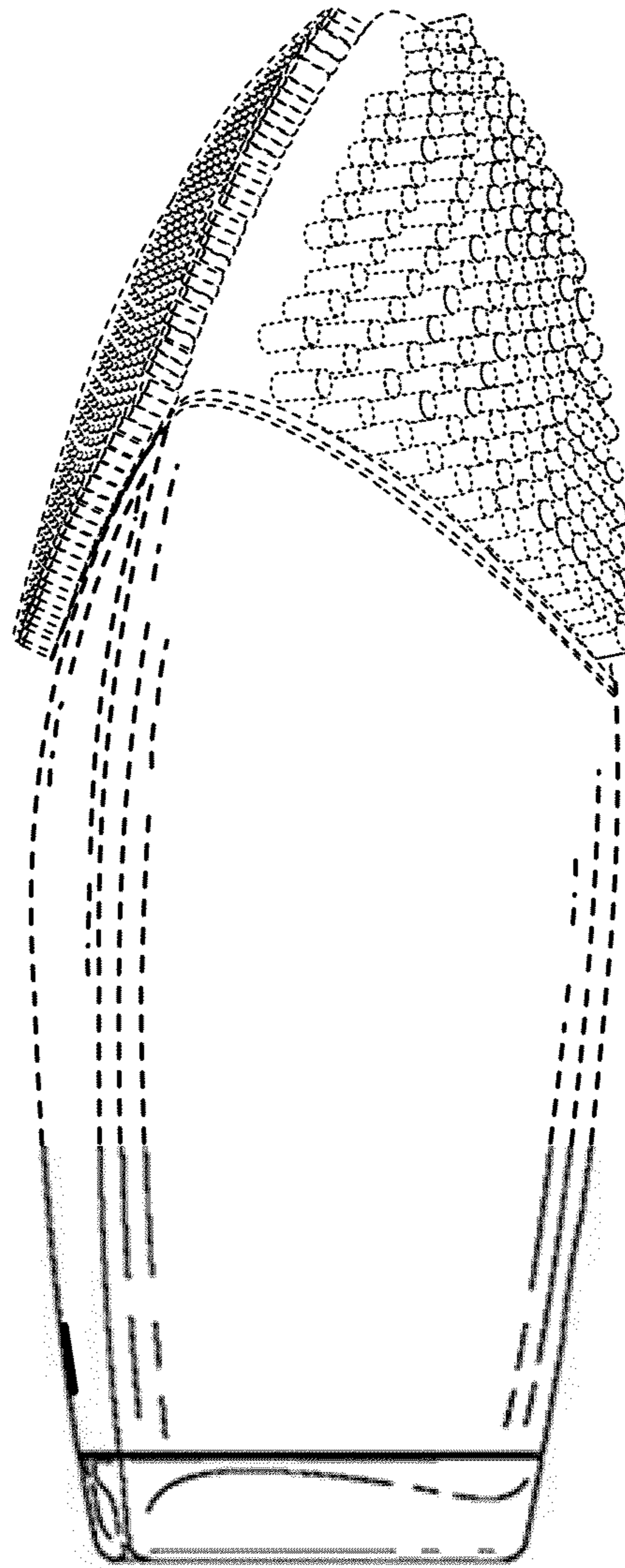

FIG. 74

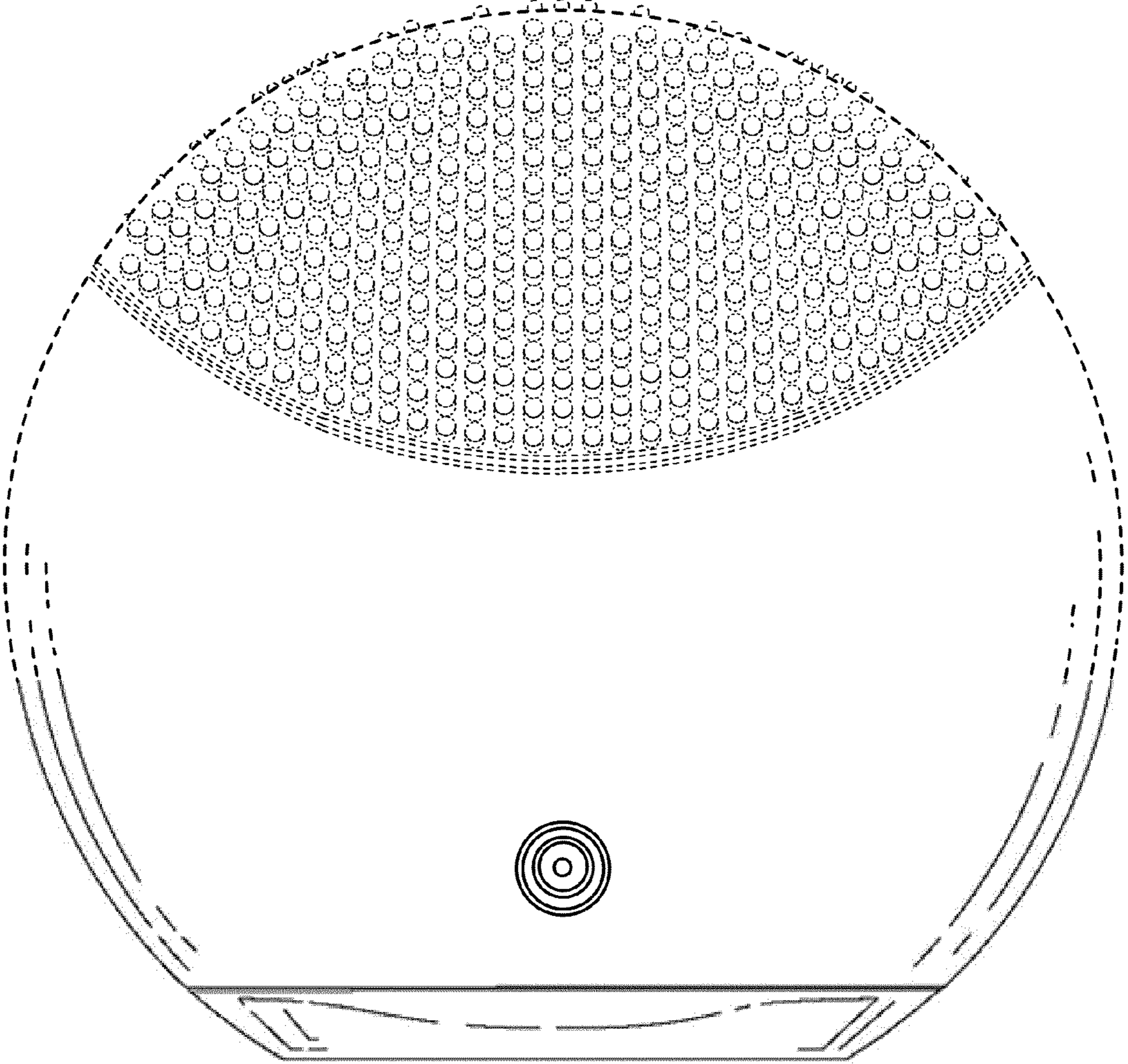

FIG. 75

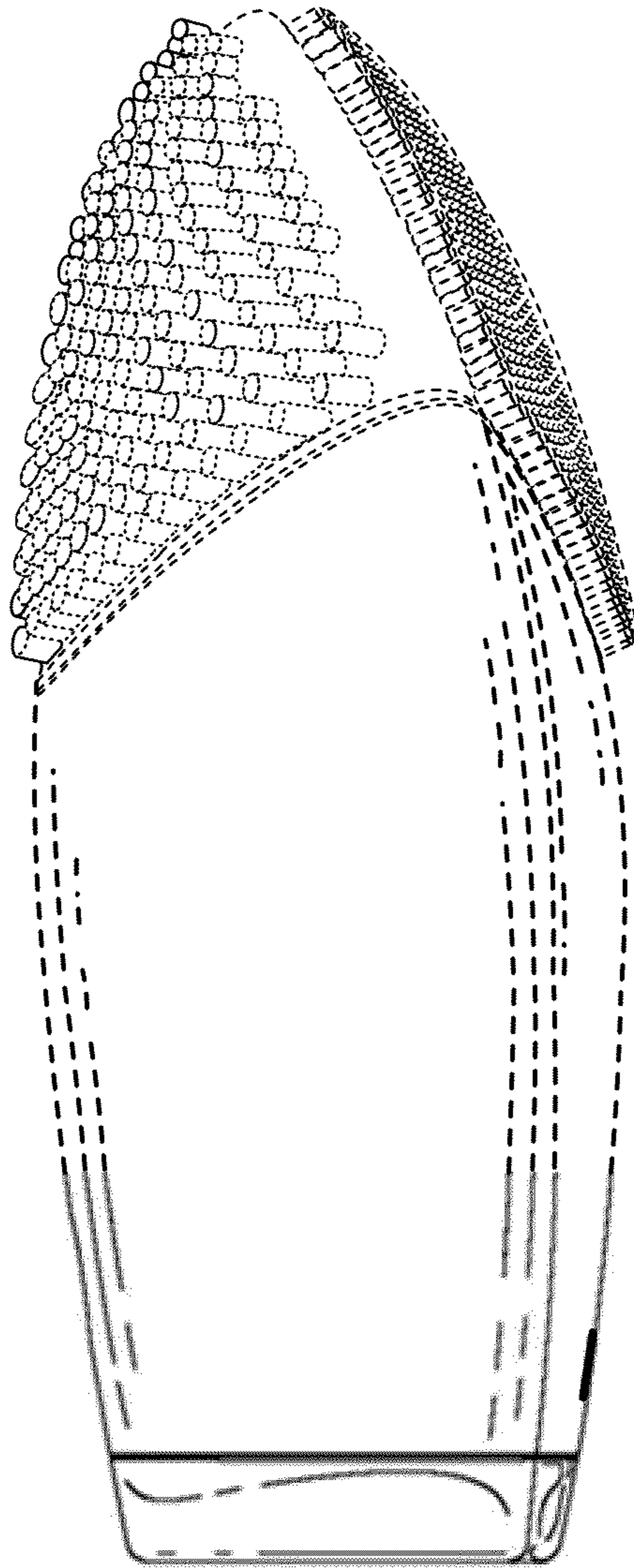

FIG. 76

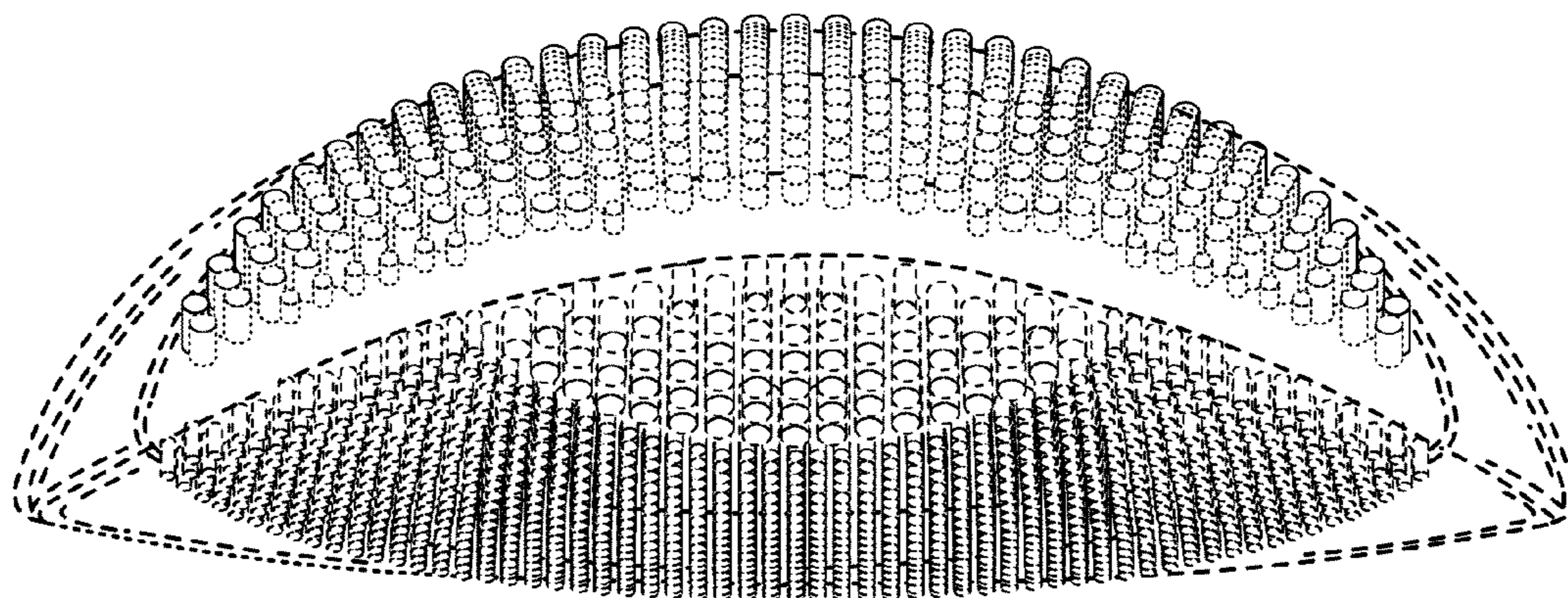

FIG. 77

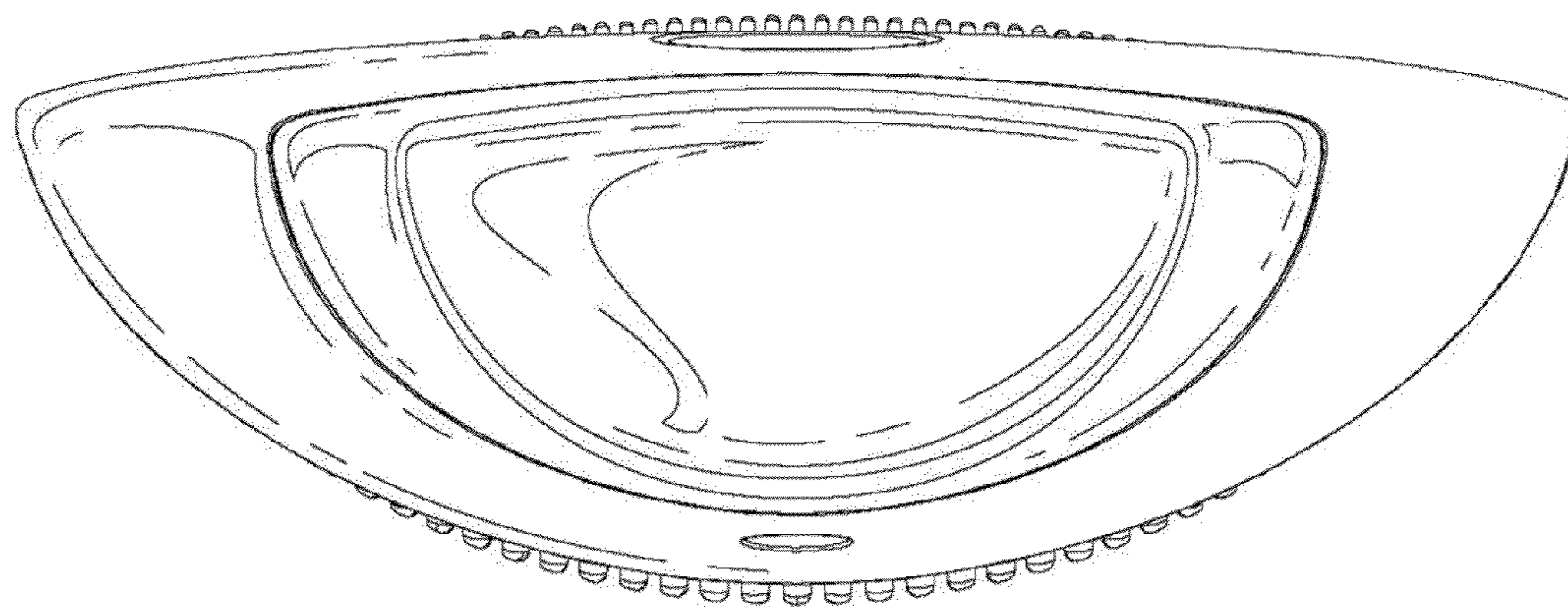

FIG. 78

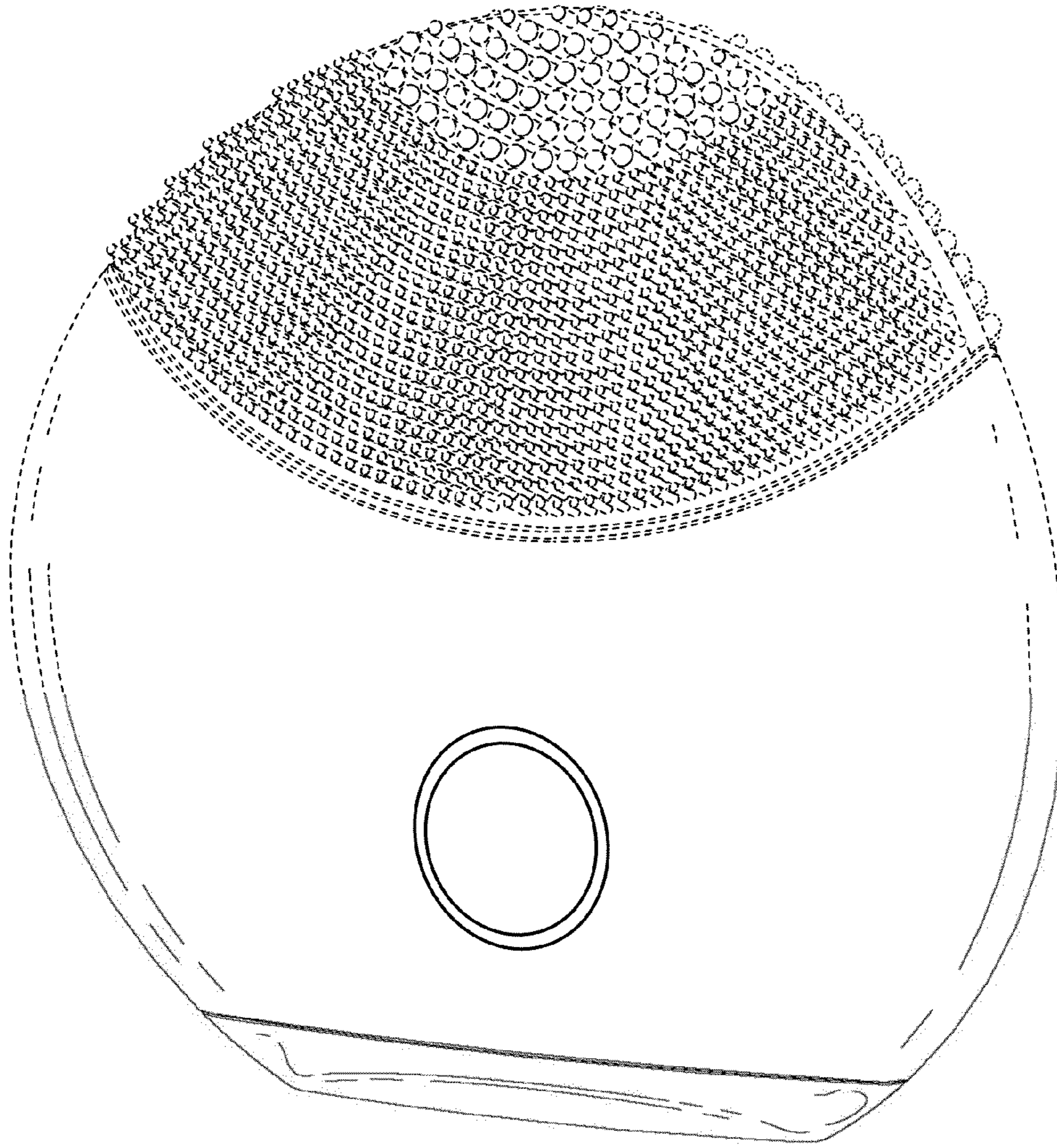

FIG. 79

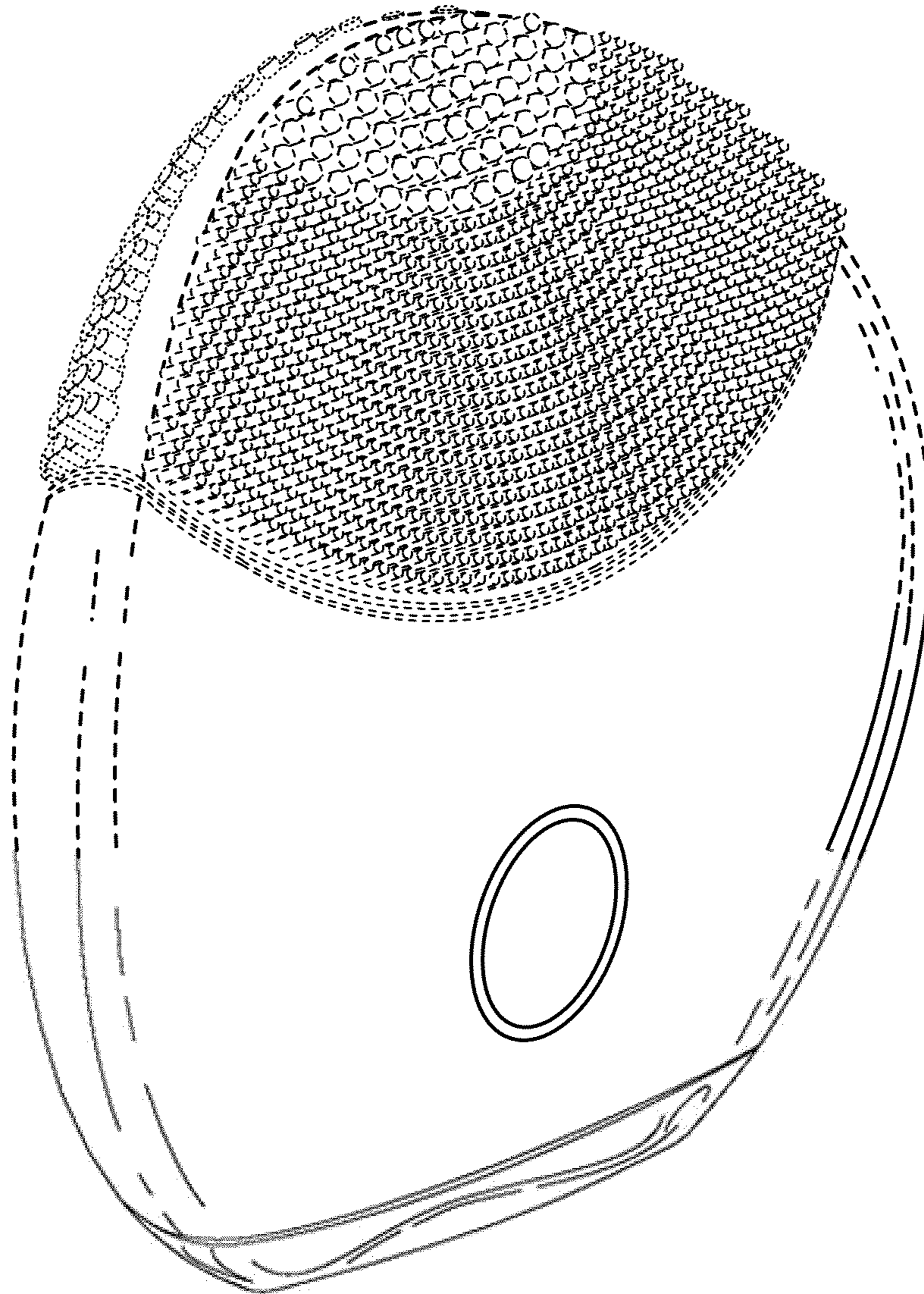

FIG. 80