



US00D734472S

(12) **United States Design Patent**
Meinertz

(10) **Patent No.:** **US D734,472 S**
(45) **Date of Patent:** **** Jul. 14, 2015**

(54) **HEARING AID**

(71) Applicant: **GN ReSound A/S**, Ballerup (DK)

(72) Inventor: **Philip Meinertz**, Gentofte (DK)

(73) Assignee: **GN RESOUND A/S**, Ballerup (DK)

(**) Term: **14 Years**

(21) Appl. No.: **29/466,669**

(22) Filed: **Sep. 10, 2013**

(30) **Foreign Application Priority Data**

Mar. 12, 2013 (EP) 002201046

(51) **LOC (10) Cl.** **24-99**

(52) **U.S. Cl.**
USPC **D24/174**

(58) **Field of Classification Search**
USPC D24/173-175, 151; D14/205, 206,
D14/223-226, 249; 381/23.1, 312,
381/322-324, 328, 330, 380, 381; 181/135
See application file for complete search history.

(56) **References Cited**

U.S. PATENT DOCUMENTS

D646,788 S * 10/2011 Dubs et al. D24/174
D667,121 S * 9/2012 Mori et al. D24/174
D676,558 S * 2/2013 Meinertz D24/174
D676,968 S * 2/2013 Meinertz D24/174

D685,912 S * 7/2013 Havn et al. D24/174
D687,952 S * 8/2013 Dubs D24/174
D698,024 S * 1/2014 Meinertz D24/174
D698,027 S * 1/2014 Olsen D24/174
D705,936 S * 5/2014 Lockenwitz D24/174
2010/0111315 A1* 5/2010 Kroman 381/60

* cited by examiner

Primary Examiner — Anhdao Doan

(74) *Attorney, Agent, or Firm* — Vista IP Law Group, LLP

(57) **CLAIM**

The ornamental design for a hearing aid, as shown and described.

DESCRIPTION

FIG. 1 is a side view of a hearing aid of my design;
FIG. 2 is another side view of the hearing aid of my design;
FIG. 3 is a perspective view of the hearing aid of my design;
FIG. 4 is another perspective view of the hearing aid of my design;
FIG. 5 is another perspective view of the hearing aid of my design;
FIG. 6 is another perspective view of the hearing aid of my design;
FIG. 7 is another side view of the hearing aid of my design;
and,
FIG. 8 is another perspective view of the hearing aid of my design.
The broken lines in the drawing views are included for the purpose of illustrating a portion of the hearing aid that forms no part of the claimed design.

1 Claim, 8 Drawing Sheets

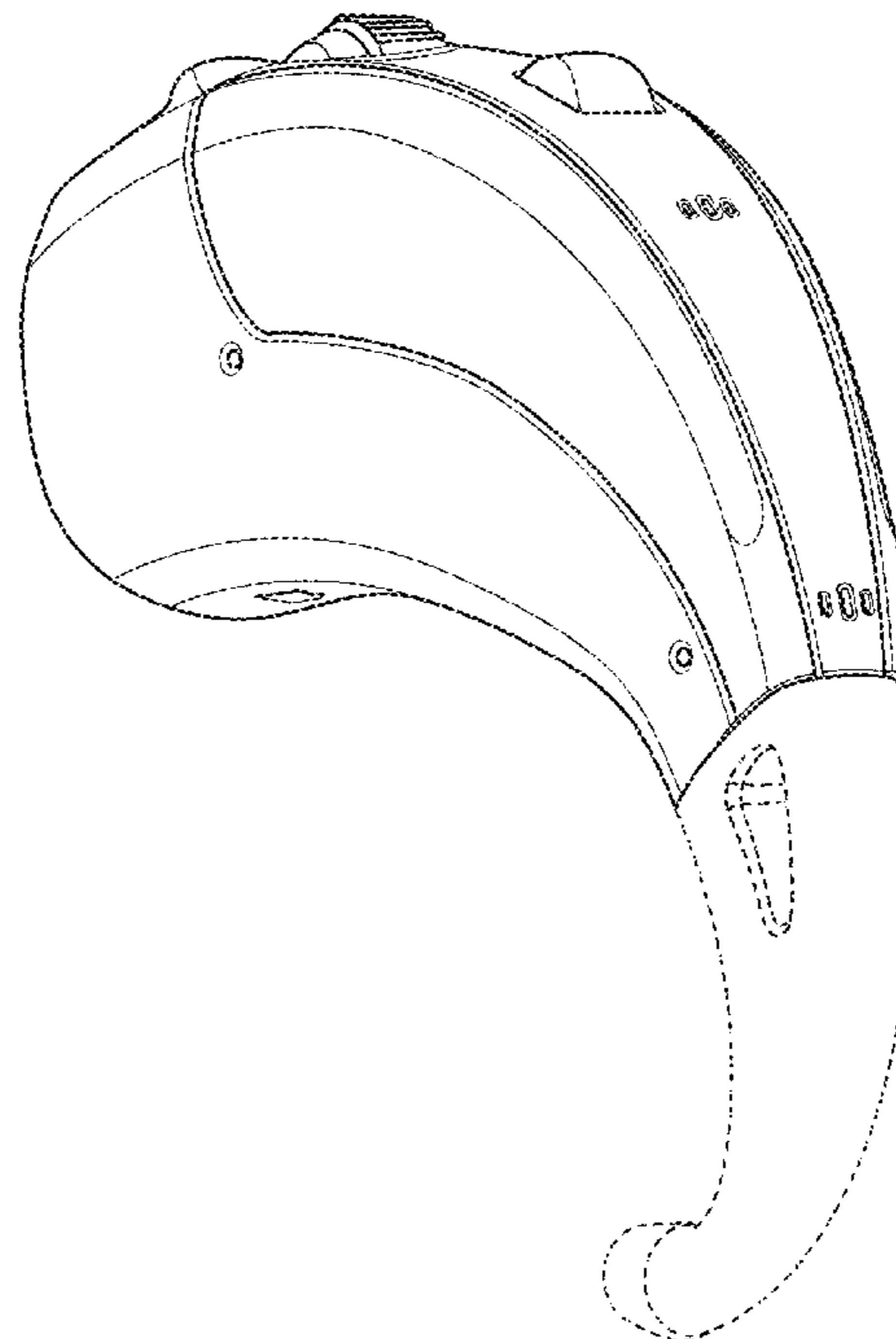
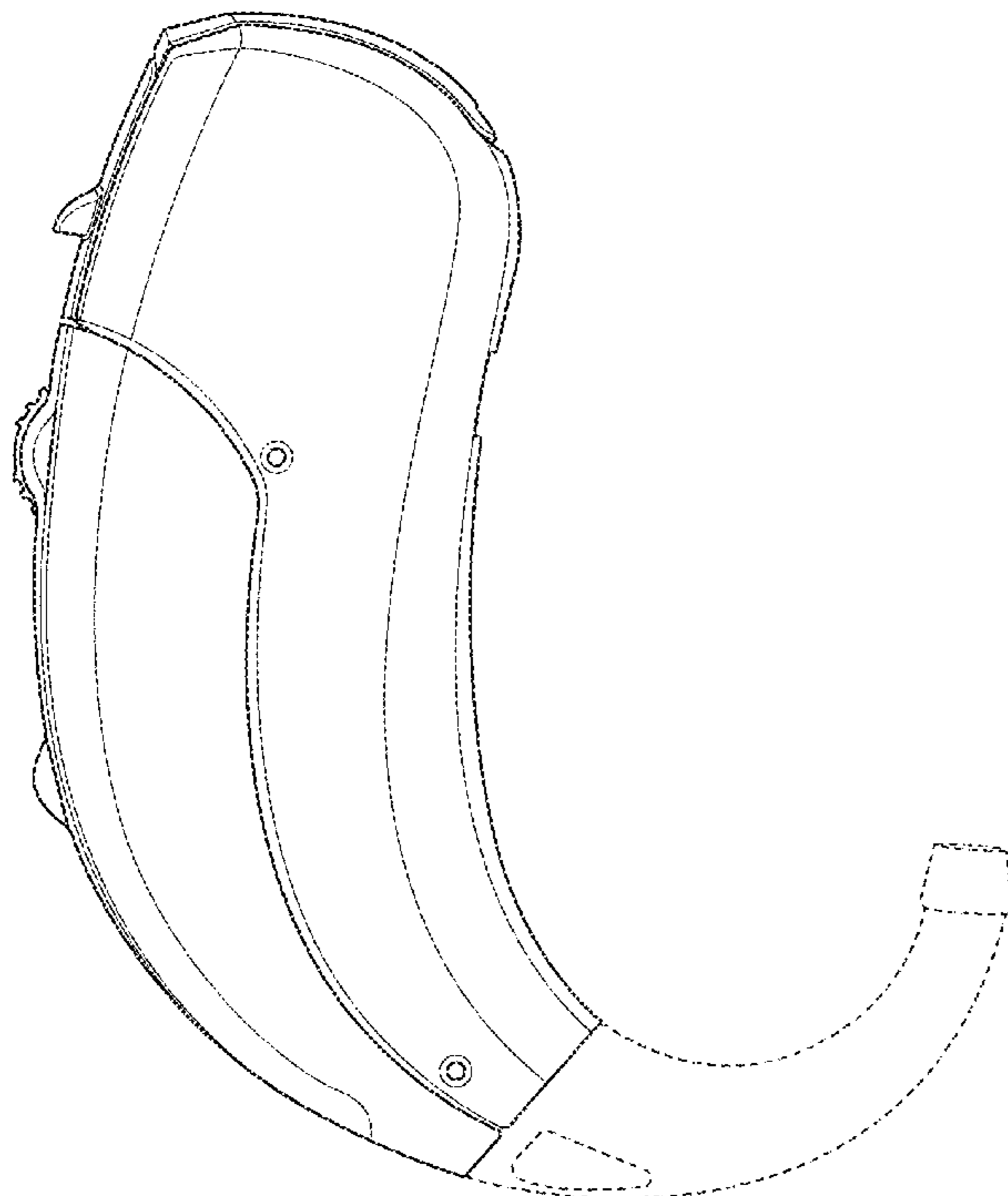

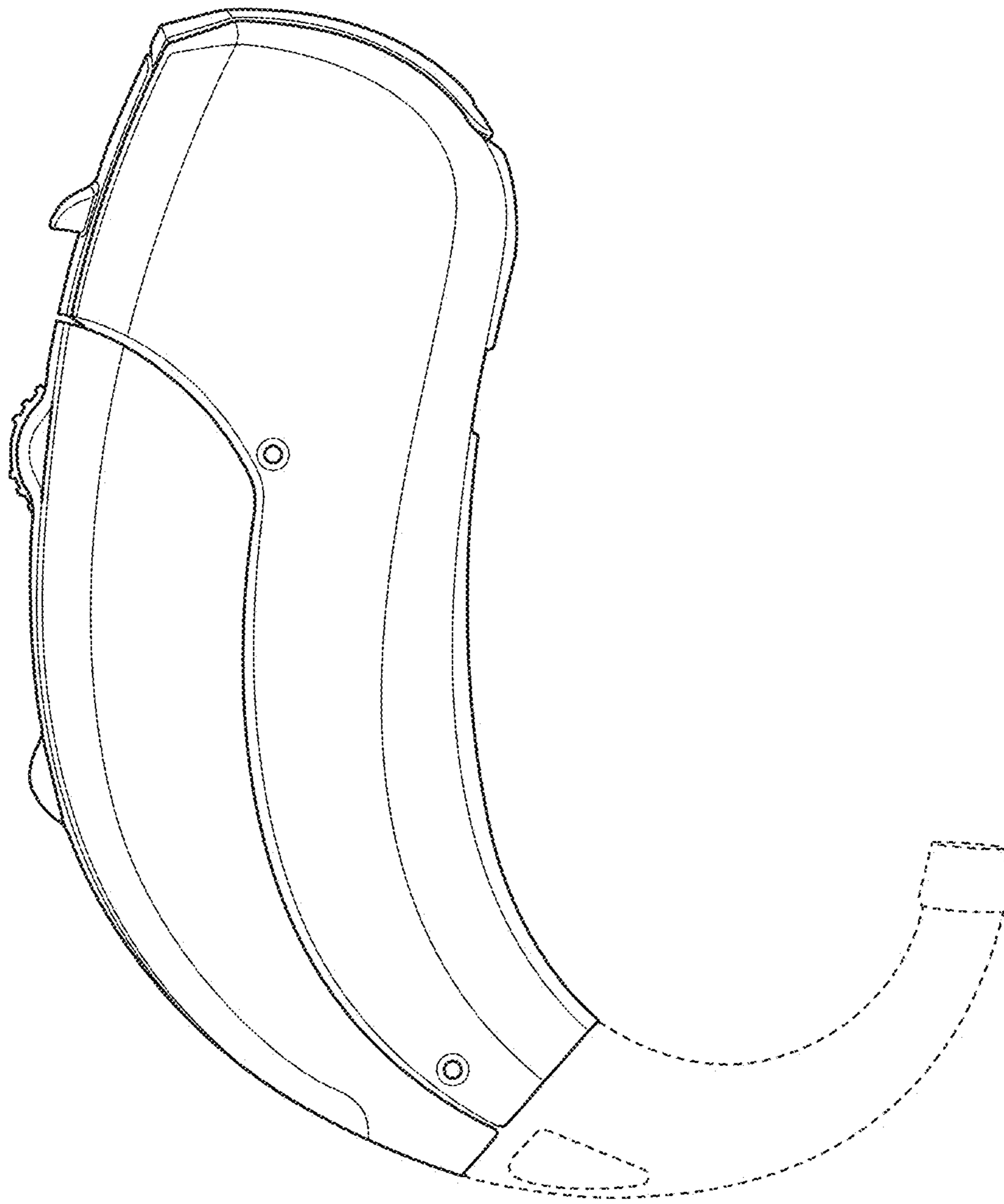

FIG. 1

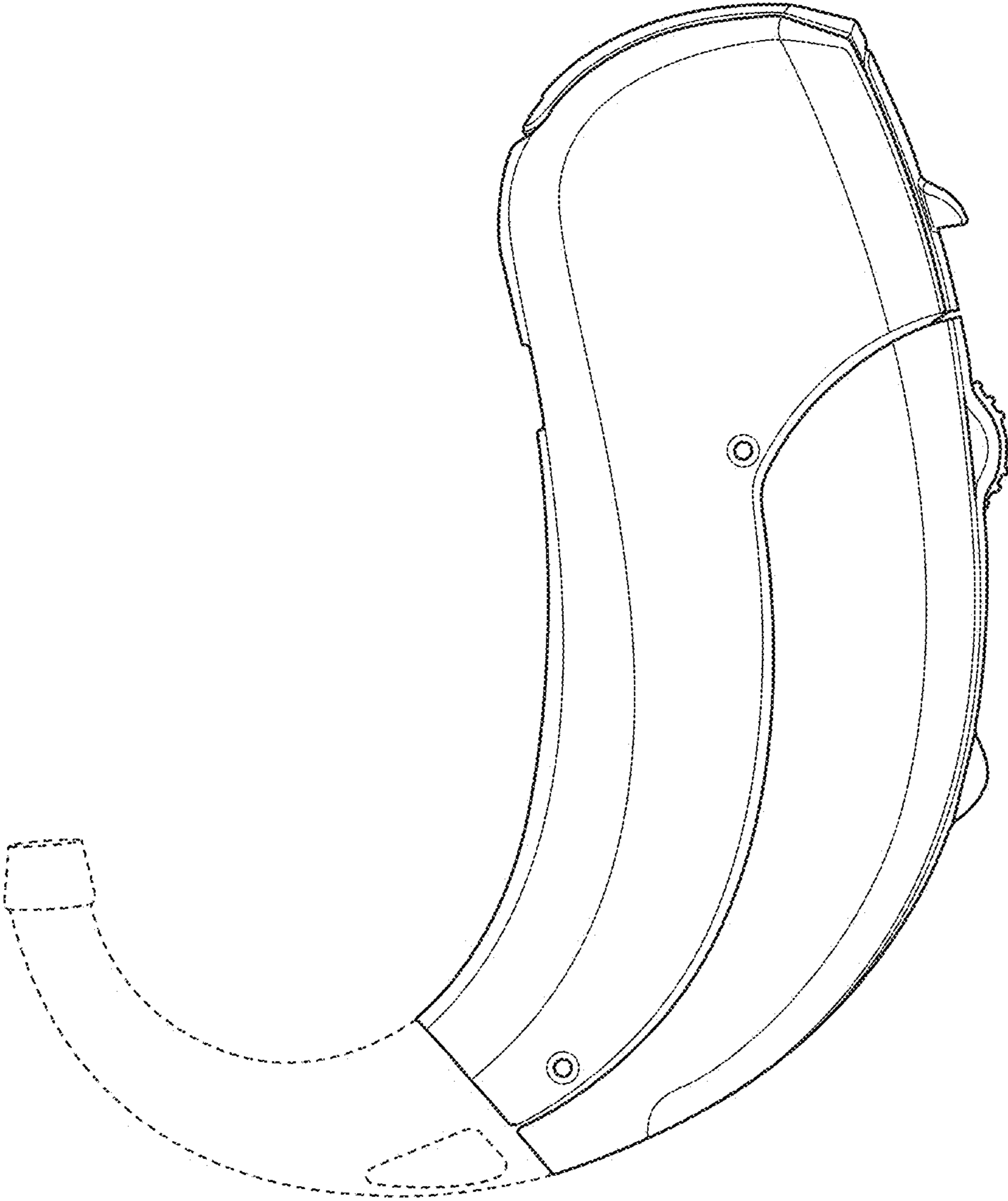

FIG. 2

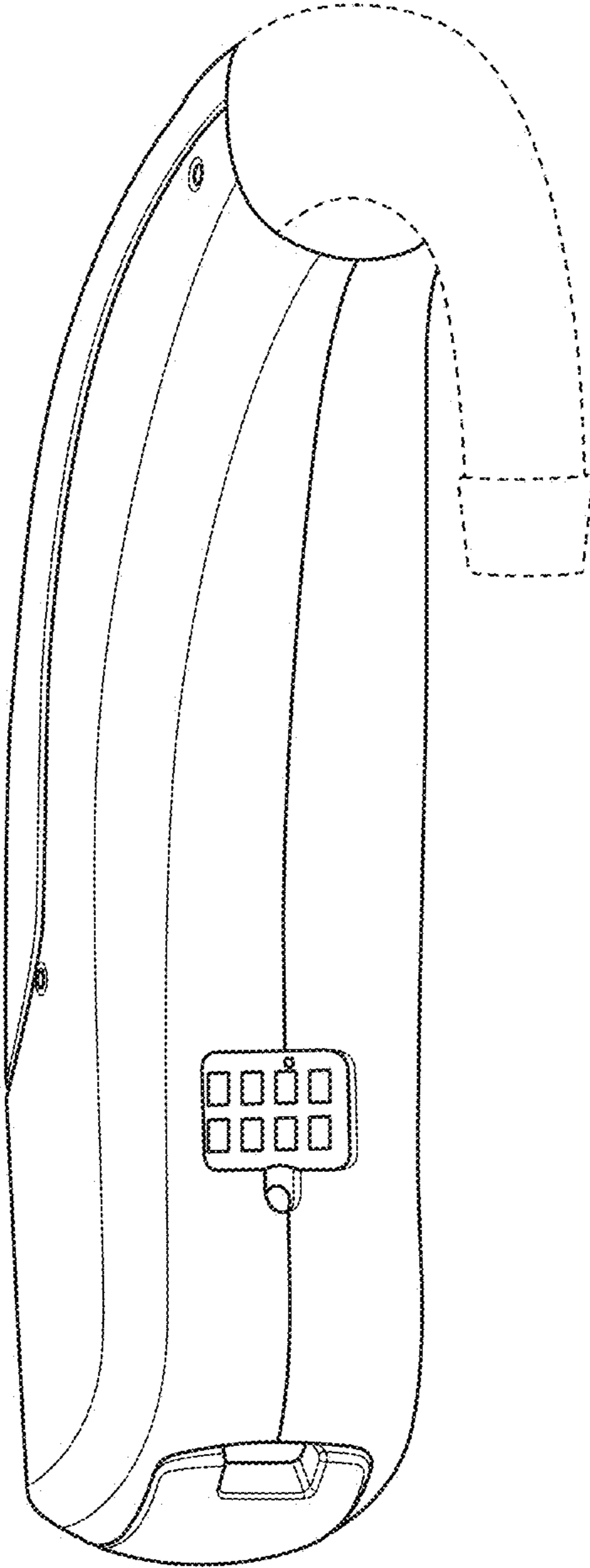

FIG. 3

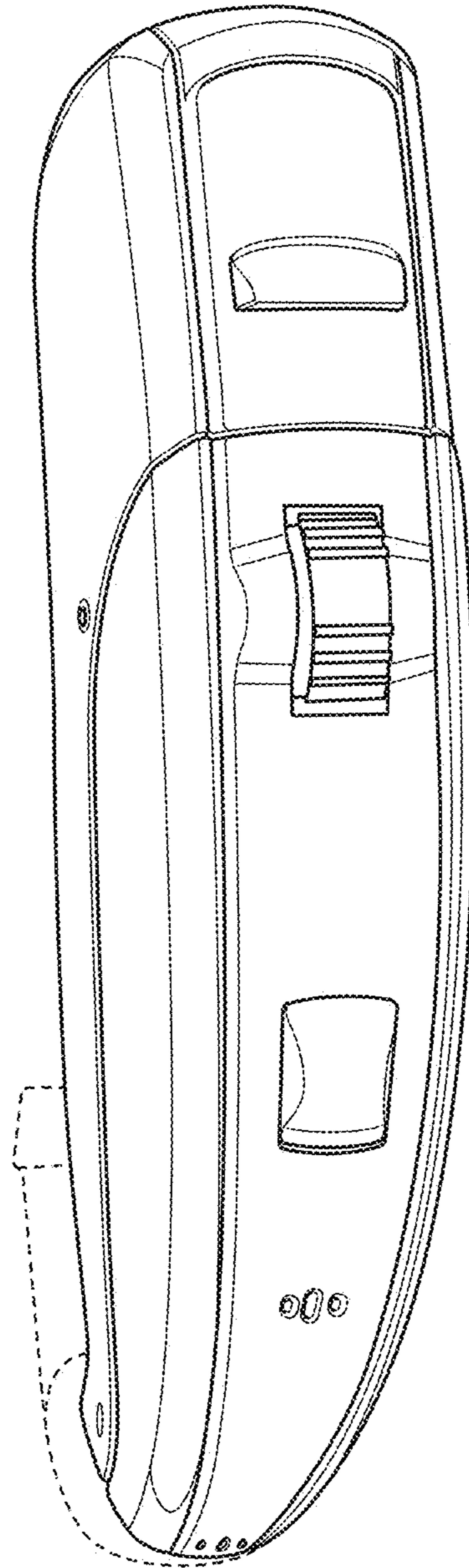

FIG. 4

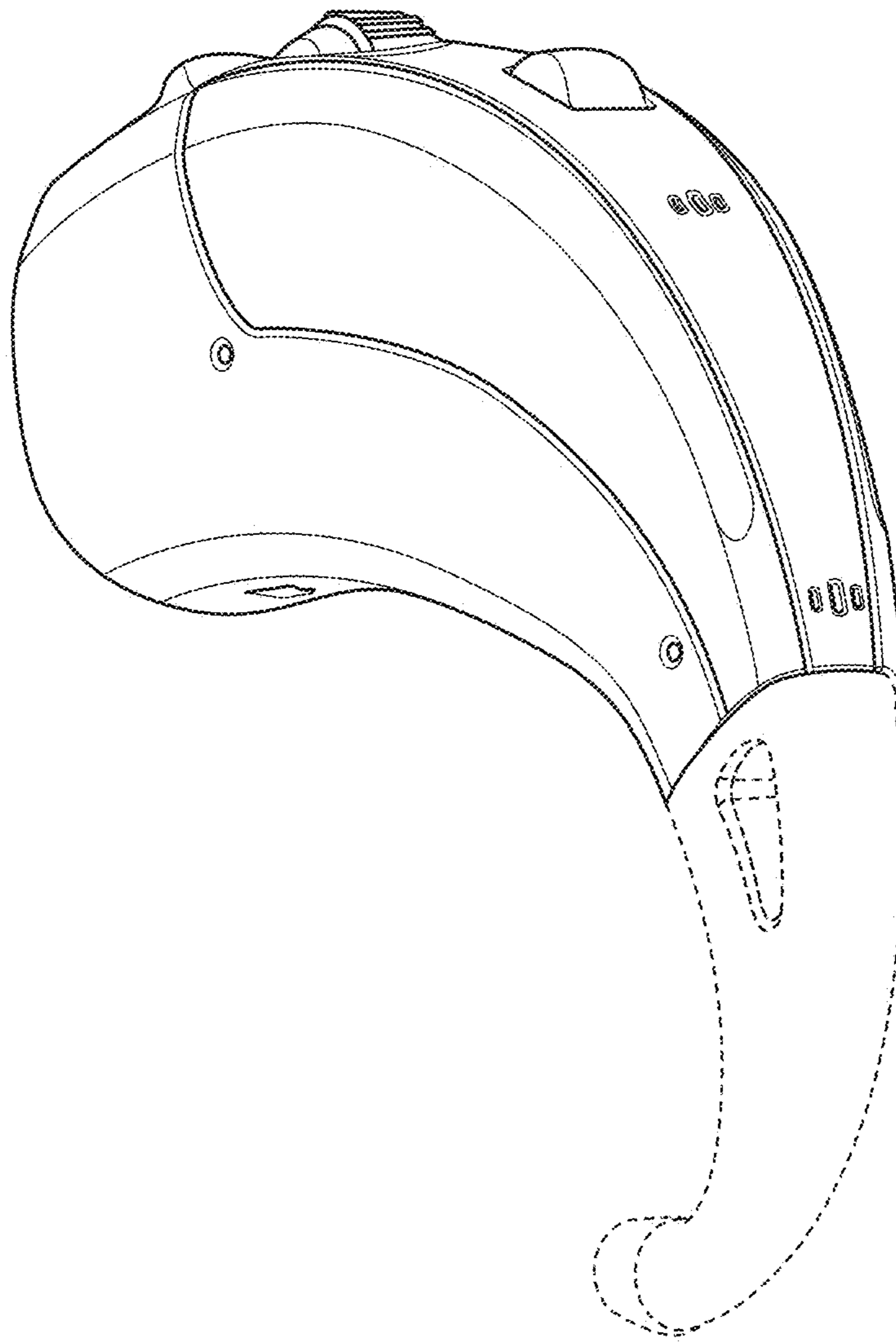

FIG. 5

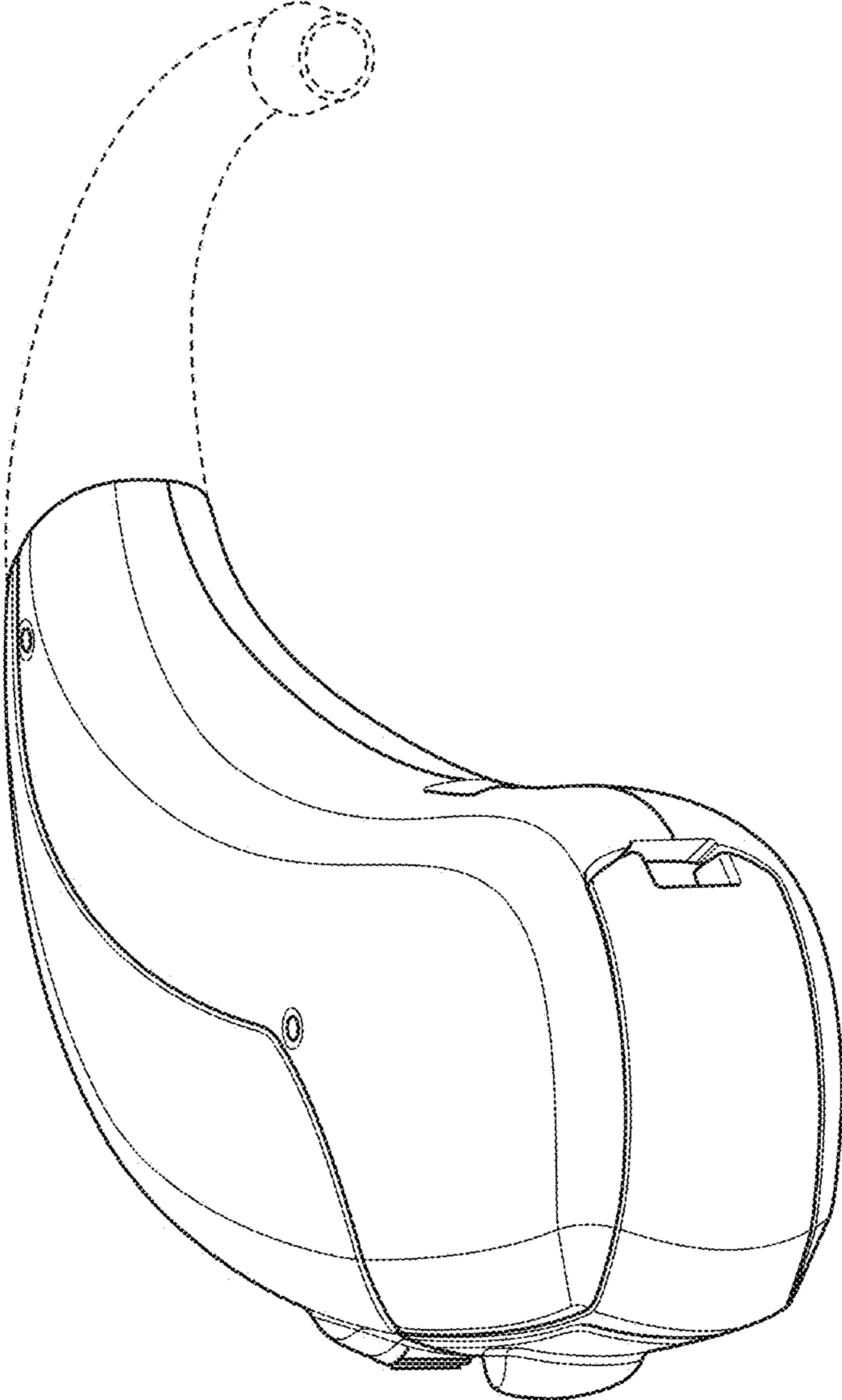

FIG. 6

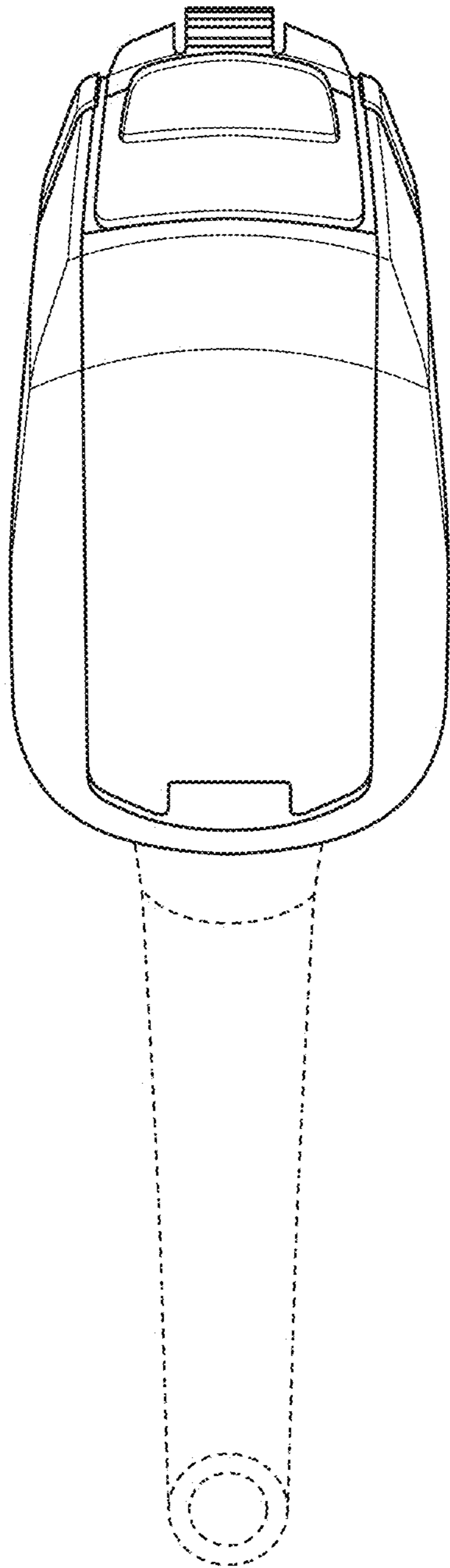

FIG. 7

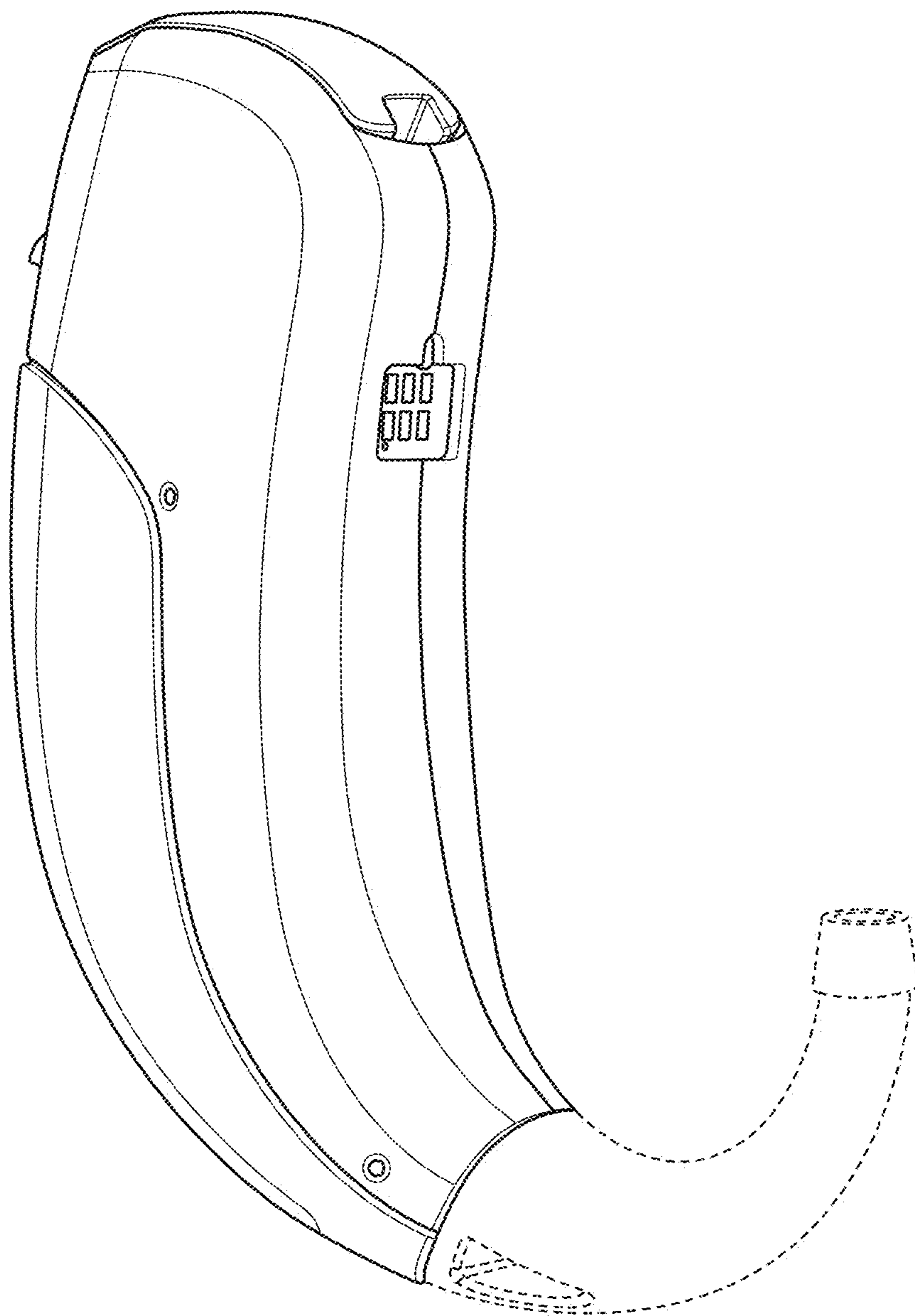

FIG. 8