



US00D734393S

(12) **United States Design Patent**
Quehl

(10) **Patent No.:** **US D734,393 S**

(45) **Date of Patent:** **** Jul. 14, 2015**

(54) **BOOKMARK**

(71) Applicant: **Lanybook GmbH**, Worms (DE)
(72) Inventor: **Alexander Quehl**, Worms (DE)
(73) Assignee: **LANYBOOK GMBH**, Worms (DE)

(**) Term: **14 Years**

(21) Appl. No.: **29/446,077**

(22) Filed: **Feb. 20, 2013**

Related U.S. Application Data

(63) Continuation-in-part of application No. 29/394,763, filed on Jun. 21, 2011, now abandoned.

Foreign Application Priority Data

Dec. 23, 2010 (EM) 001798000

(51) **LOC (10) Cl.** **19-99**

(52) **U.S. Cl.**
USPC **D19/34**

(58) **Field of Classification Search**
USPC D19/32, 34, 26, 28, 65, 99, 100;
D20/22, 23, 24, 27, 40, 42, 99;
281/15.1, 42, 51; D21/606, 658, 576,
D21/398, 385, 386, 483; D11/99, 100, 107,
D11/184, 200, 201; D8/14, 16, 349, 394,
D8/499; D3/247, 318, 327
CPC A45C 11/182; B42D 3/18; B42D 3/145;
B42D 9/00; B42D 9/001; B42D 9/002;
B42D 9/004; B42D 9/005; B42D 9/007;
B65D 63/1018; B65D 2241/04; Y10T 24/00

See application file for complete search history.

(56) **References Cited**

U.S. PATENT DOCUMENTS

132,230 A 10/1872 Arms
151,036 A 5/1874 Liebenroth
152,876 A 7/1874 Smith
212,578 A 2/1879 Smith

(Continued)

FOREIGN PATENT DOCUMENTS

DE 402009001339.8 7/2009
EM 001519315/01-0017 11/2009

(Continued)

Primary Examiner — Sheryl Lane

Assistant Examiner — Ieisha Price

(74) *Attorney, Agent, or Firm* — Medley, Behrens & Lewis, LLC; Lorri W. Cooper

(57) **CLAIM**

The ornamental design for a bookmark, as shown and described.

DESCRIPTION

FIG. 1 is a perspective view of a bookmark showing my new design.

FIG. 2 is a front view of the bookmark shown in FIG. 1;
FIG. 3 is a back view of the bookmark shown in FIG. 1;
FIG. 4 is a left side view of the bookmark shown in FIG. 1;
FIG. 5 is a right side view of the bookmark shown in FIG. 1;
FIG. 6 is a bottom view of the bookmark shown in FIG. 1; and,
FIG. 7 is a top view of the bookmark shown in FIG. 1.

The broken line shown in FIG. 1 illustrates the environment of the claimed design and forms no part thereof.

The dash-dot-dash lines shown in FIGS. 1-5 define the bounds of the claimed design and form no part thereof.

1 Claim, 1 Drawing Sheet

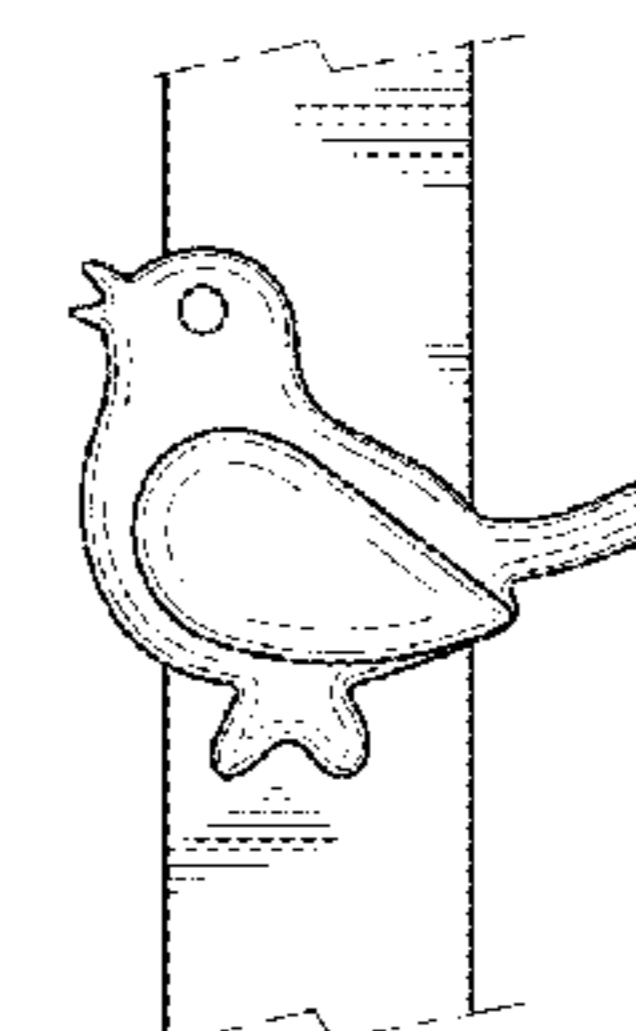
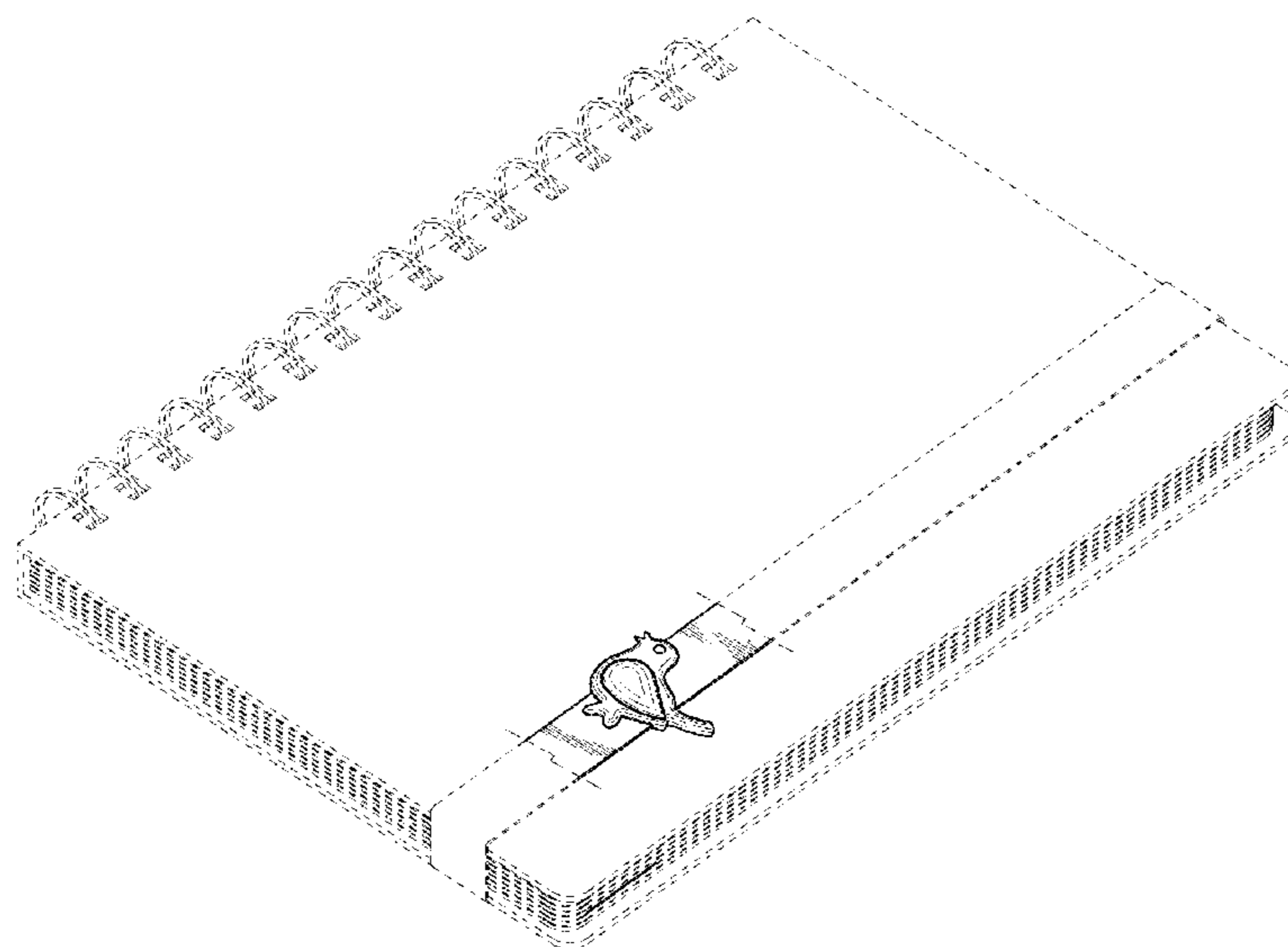

(56)

References Cited

U.S. PATENT DOCUMENTS

308,942 A 12/1884 Yewell
 345,660 A 7/1886 Ashworth
 D24,233 S * 4/1895 Stone D19/34
 1,619,644 A 3/1927 Wetzell
 1,960,690 A 5/1934 Blair
 2,716,390 A * 8/1955 Goins 116/235
 4,041,892 A * 8/1977 Nichols 116/239
 4,162,800 A 7/1979 Gonot, Jr. et al.
 4,462,614 A * 7/1984 Krause 281/42
 4,505,219 A 3/1985 Mangano
 5,054,816 A 10/1991 Rosengarten
 D346,399 S * 4/1994 Schad et al. D19/34
 5,622,387 A * 4/1997 Ordway 281/42
 D408,615 S * 4/1999 Sterr et al. D11/184
 D424,108 S 5/2000 Mitcham
 6,155,602 A * 12/2000 Mylander et al. 281/42
 6,230,878 B1 5/2001 Lehr
 D449,648 S 10/2001 Andler
 6,308,988 B1 10/2001 Mylander et al.

D505,699 S * 5/2005 Lawson D20/23
 D517,604 S 3/2006 Rowe
 D527,898 S 9/2006 Tavone
 7,125,049 B2 * 10/2006 Goldberg et al. 281/42
 D534,584 S 1/2007 Goldberg et al.
 D554,450 S * 11/2007 Raia D7/695
 D569,427 S 5/2008 Lundvall
 D580,988 S 11/2008 Regala
 D584,049 S * 1/2009 Uzelac D3/247
 D587,158 S 2/2009 Trapani et al.
 D604,764 S 11/2009 Velonis
 D671,823 S * 12/2012 van der Lande D8/395
 D672,818 S * 12/2012 Pascale D19/65
 D704,263 S * 5/2014 Pascale D19/99
 2012/0067942 A1 * 3/2012 Quehl 229/67.4
 2013/0099472 A1 * 4/2013 Quehl 281/29

FOREIGN PATENT DOCUMENTS

GB 2451669 A * 2/2009 B42P 2241/04
 KR 20010069840 A * 7/2001 B42D 9/004

* cited by examiner

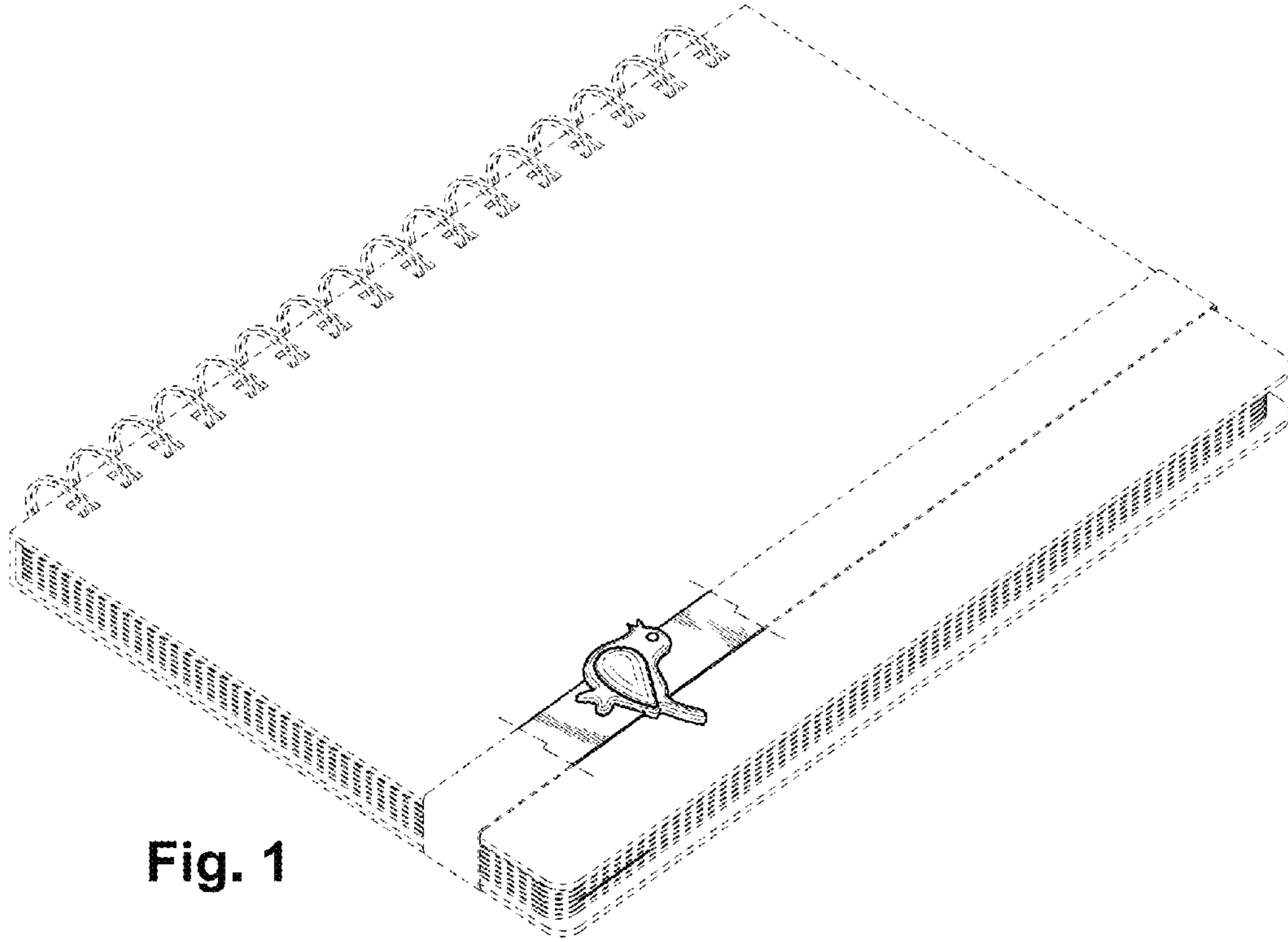

Fig. 1

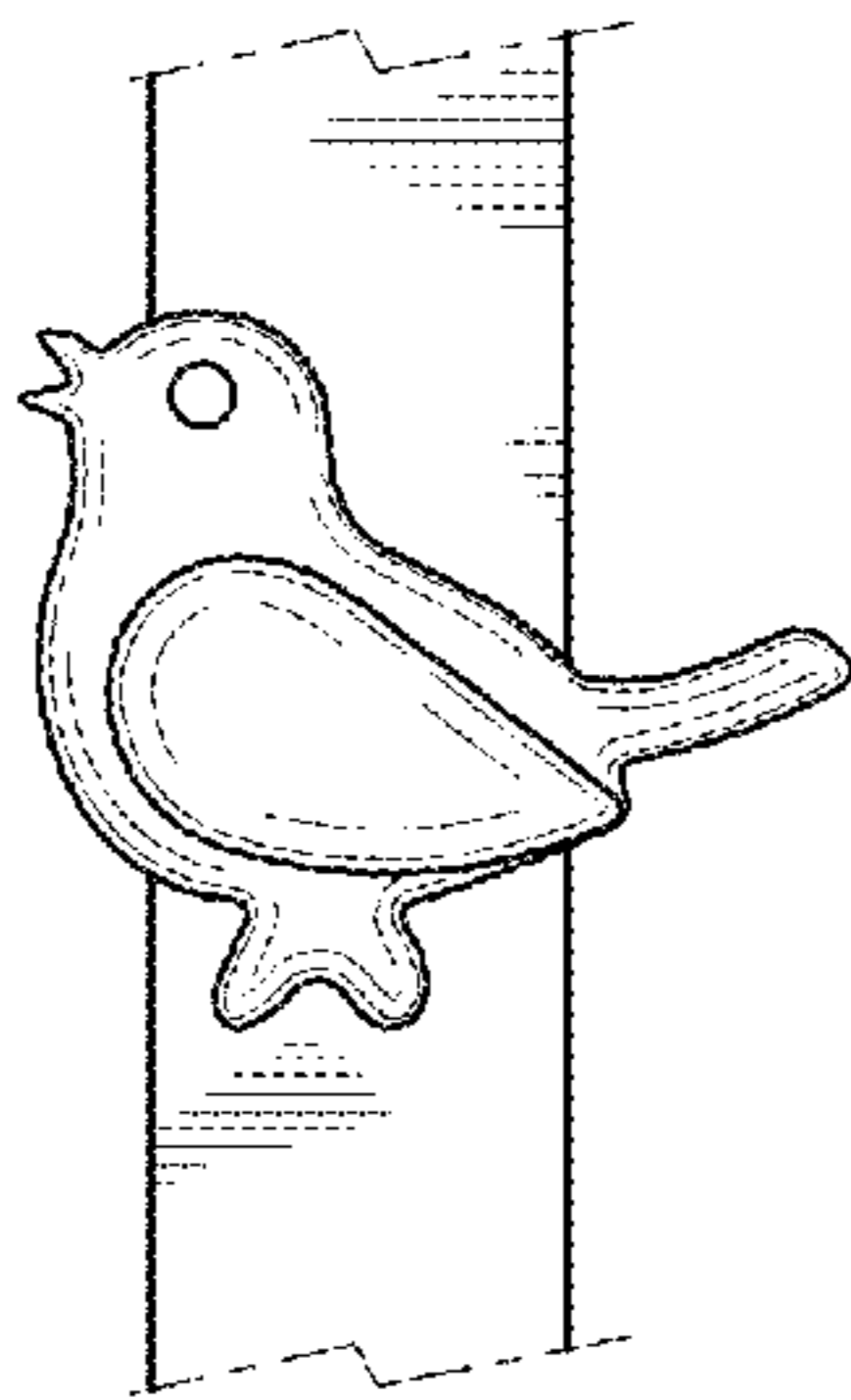

Fig. 2

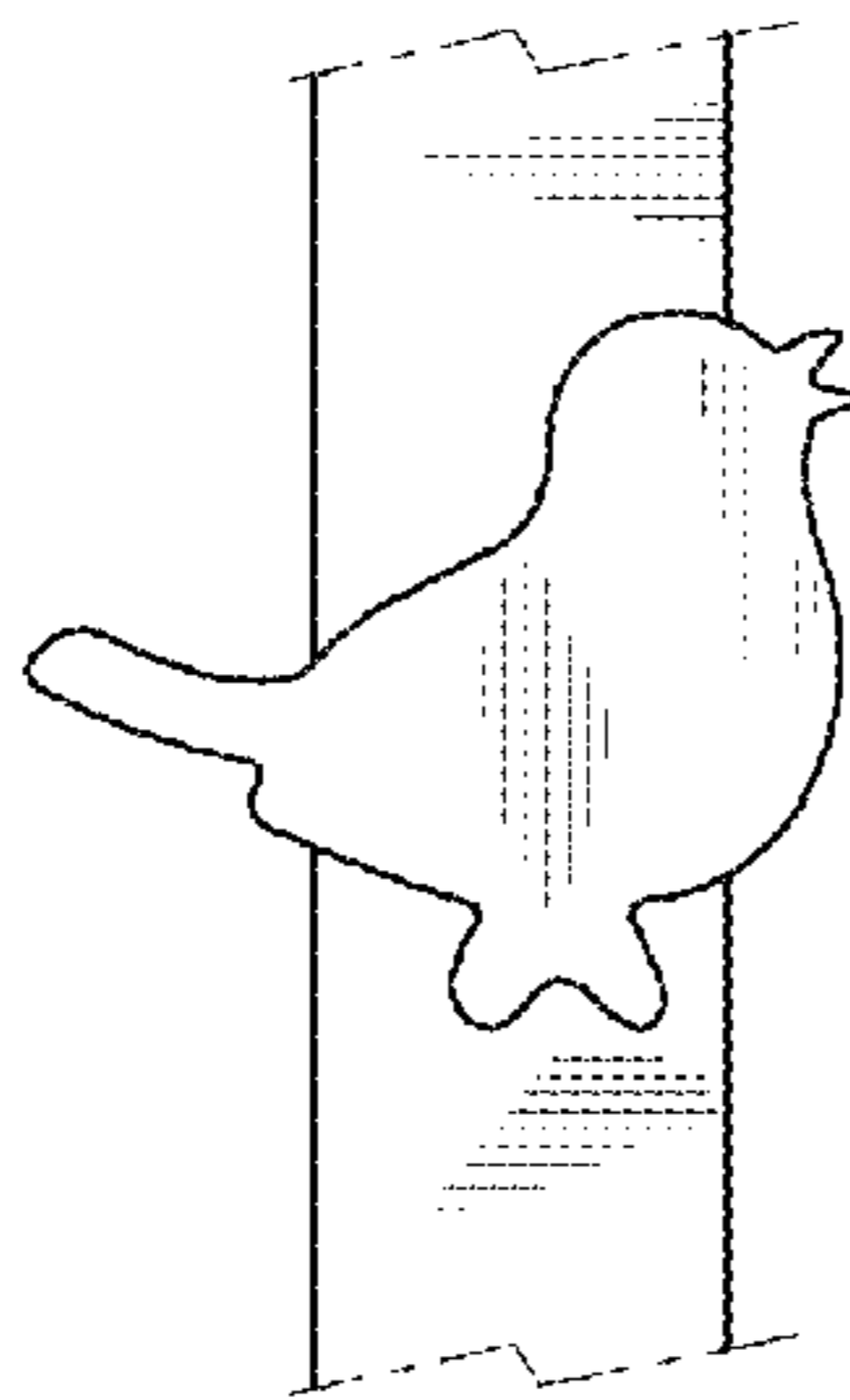

Fig. 3

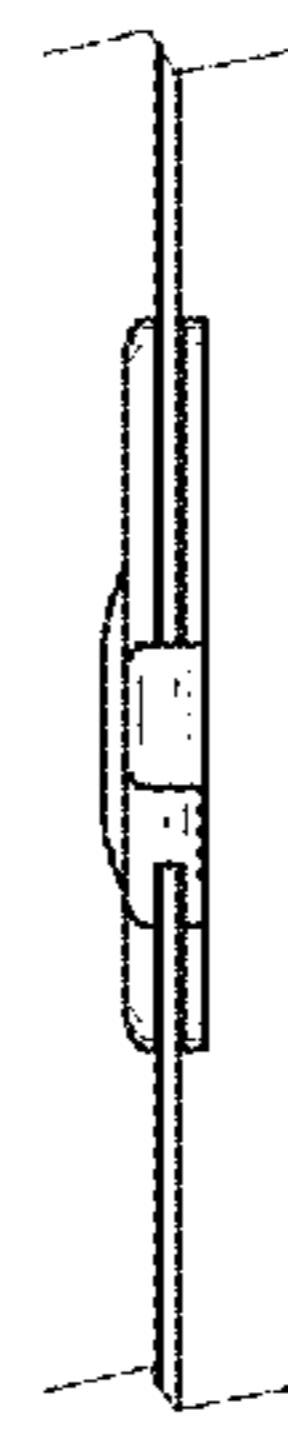

Fig. 4

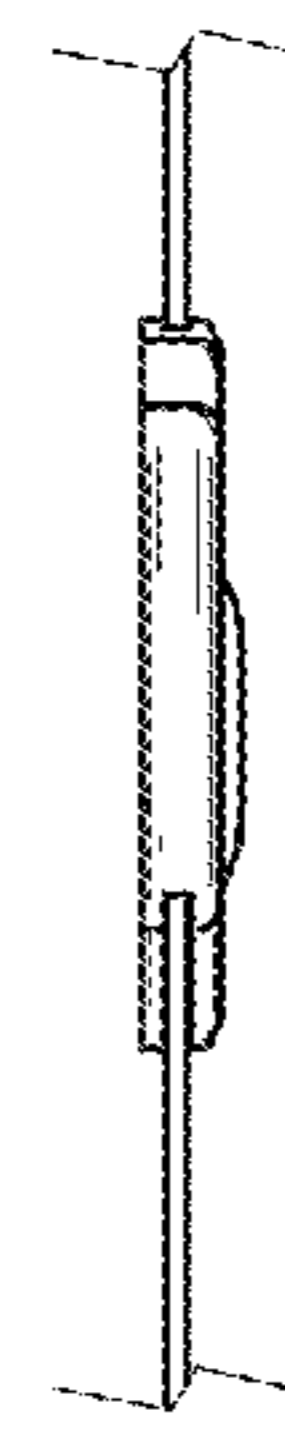

Fig. 5

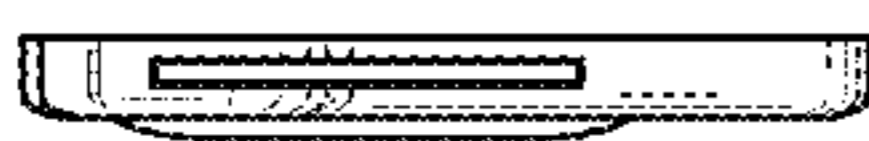

Fig. 6

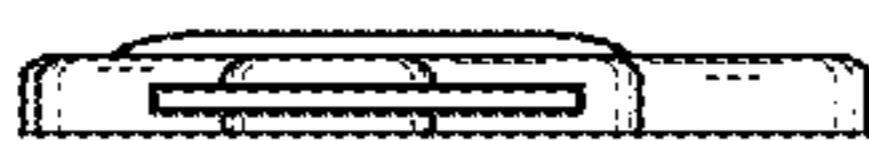

Fig. 7