



US00D734168S

(12) **United States Design Patent**  
**Rajaiah et al.**

(10) **Patent No.:** **US D734,168 S**

(45) **Date of Patent:** **\*\* Jul. 14, 2015**

(54) **DENTURE ADHESIVE PACKAGE AND CAP**

(56) **References Cited**

(71) Applicant: **The Procter & Gamble Company,**  
Cincinnati, OH (US)

U.S. PATENT DOCUMENTS

(72) Inventors: **Jayanth Rajaiah,** Loveland, OH (US);  
**Robert Scott Leonard,** Fairfield, OH  
(US); **Tina Marie Bernard,**  
Middletown, OH (US); **Luisa Navarro**  
**Cerda,** Cincinnati, OH (US); **Thin**  
**Nguyen Ha,** Cincinnati, OH (US)

D296,081 S \* 6/1988 Kuboshima ..... D9/443  
D375,256 S \* 11/1996 Chadfield ..... D9/724  
D529,817 S \* 10/2006 Francavilla et al. .... D9/724  
D654,375 S \* 2/2012 Kuboshima ..... D9/724

(73) Assignee: **THE PROCTER & GAMBLE CO,**  
Cincinnati, OH (US)

\* cited by examiner

(\*\*) Term: **14 Years**

*Primary Examiner* — Derrick Holland

*Assistant Examiner* — Janice Lim

(21) Appl. No.: **29/460,086**

(74) *Attorney, Agent, or Firm* — James E. Oehlenschlager

(22) Filed: **Jul. 8, 2013**

(51) **LOC (10) Cl.** ..... **09-01**

(52) **U.S. Cl.**

USPC ..... **D9/724**

(58) **Field of Classification Search**

USPC ..... D3/202, 203.1; D9/500, 516, 529, 549,  
D9/550, 556, 558, 571, 723, 724, 727;  
D24/100, 108, 115; D28/4, 7, 9, 73,  
D28/76, 85; 206/385; 222/1, 71, 173;  
604/295; 606/204.25

See application file for complete search history.

(57) **CLAIM**

The ornamental design for a denture adhesive package and cap, as shown and described.

**DESCRIPTION**

FIG. 1 is a perspective view of a denture adhesive package and cap, showing our new design;

FIG. 2 is a front view thereof;

FIG. 3 is a right side view thereof;

FIG. 4 is a left side view thereof;

FIG. 5 is a back view thereof;

FIG. 6 is a top view thereof; and,

FIG. 7 is a bottom view thereof.

The broken line portions of FIGS. 1, 2, and 6 are included to show unclaimed subject matter only and form no part of the claimed design.

**1 Claim, 2 Drawing Sheets**

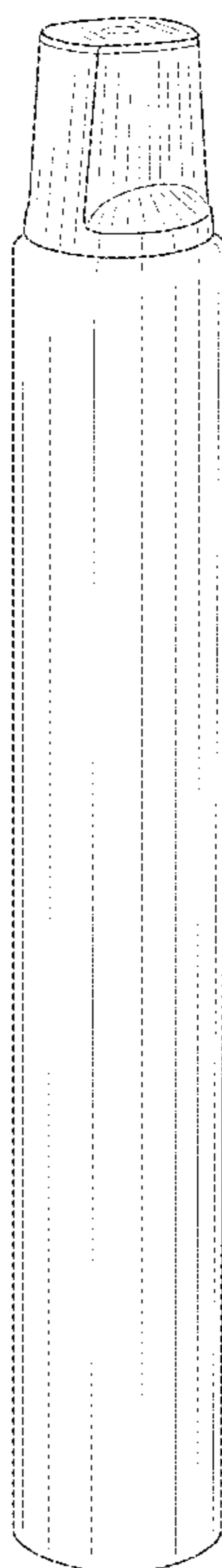

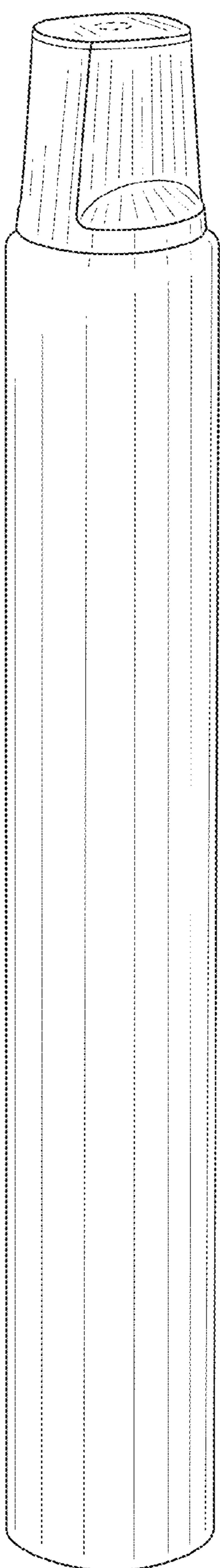

Fig. 1

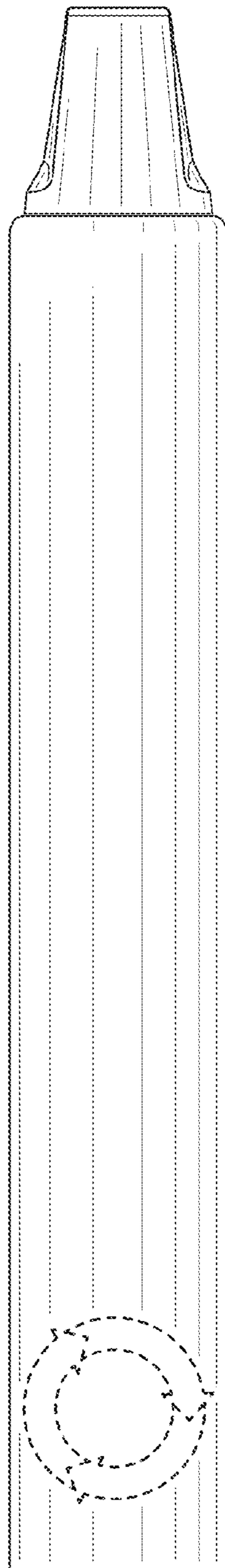

Fig. 2

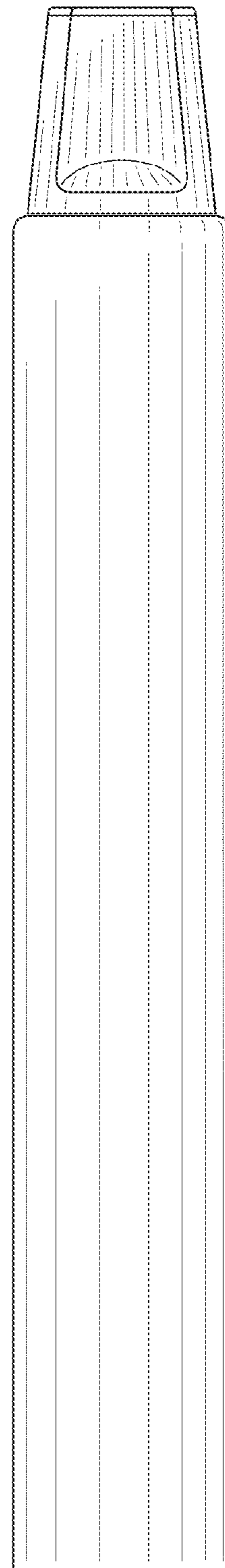

Fig. 3

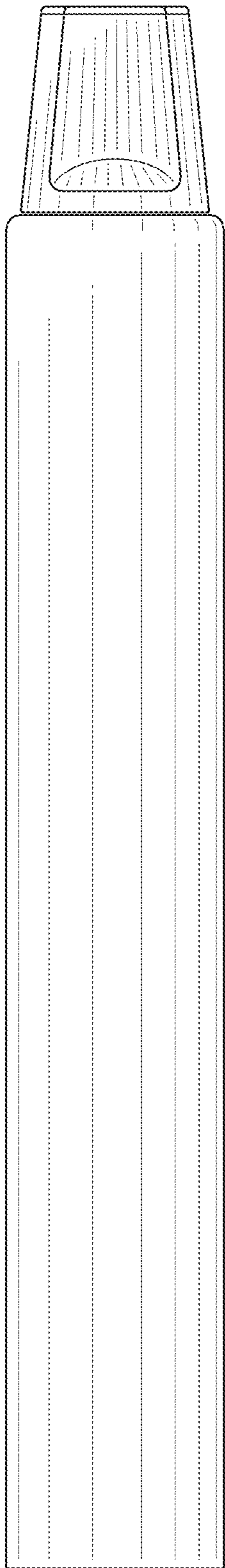

Fig. 4

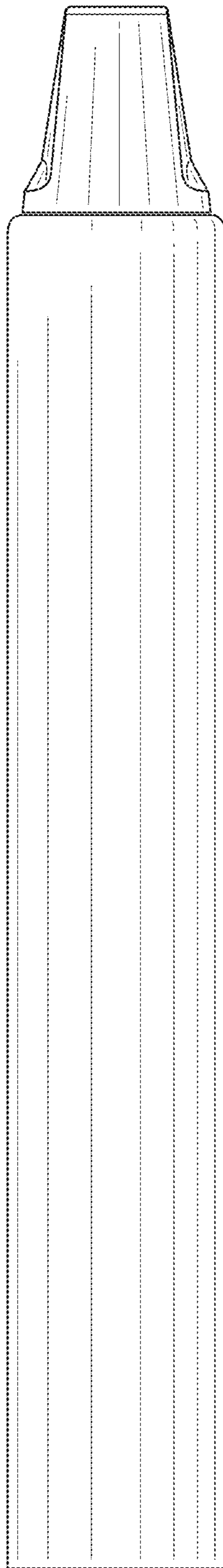

Fig. 5

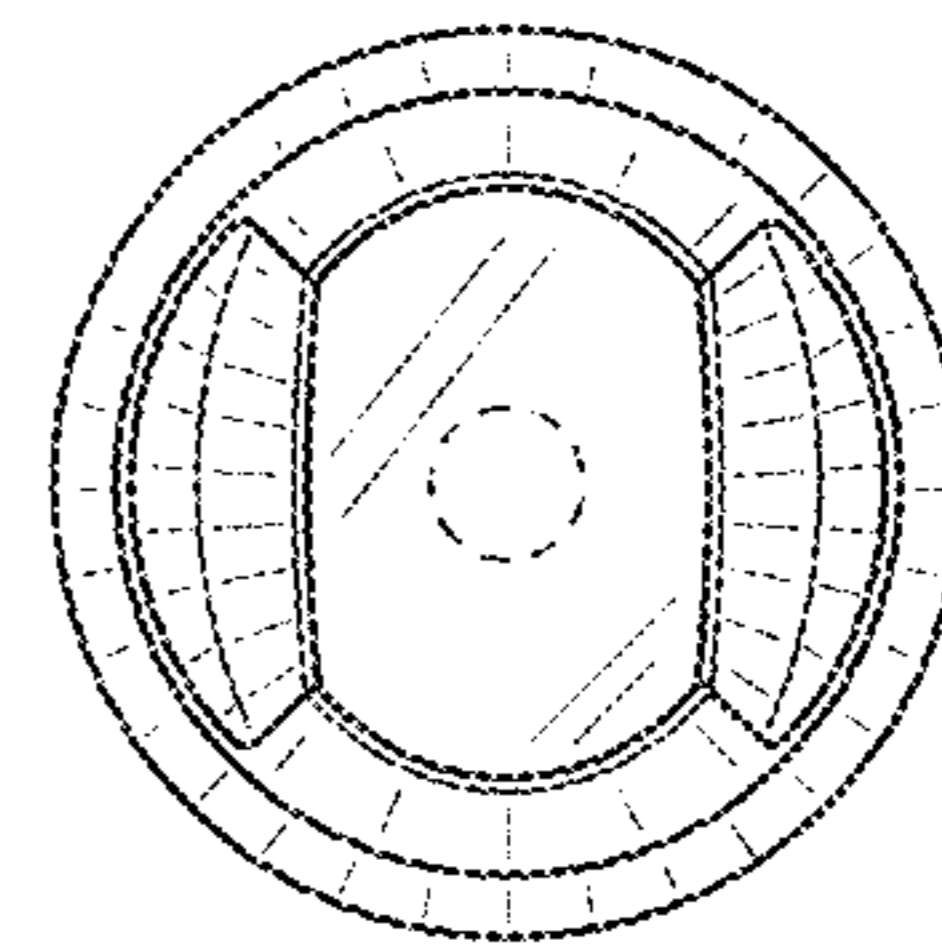

Fig. 6

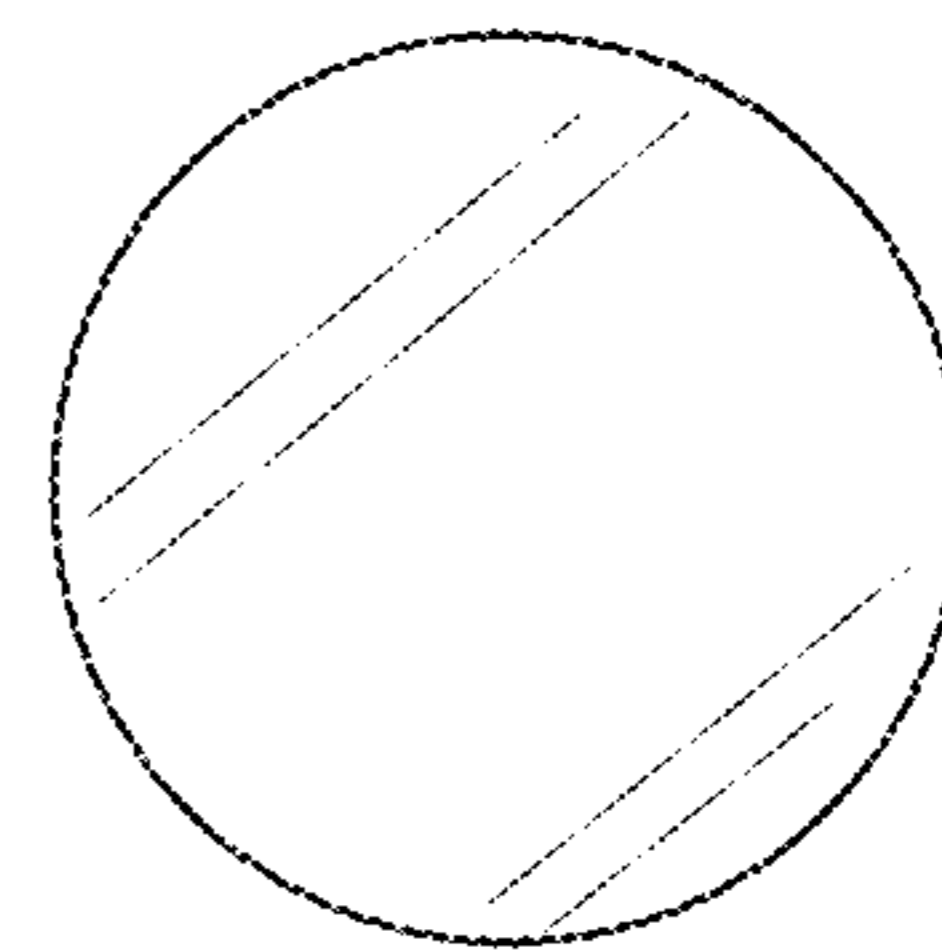

Fig. 7