



US00D734128S

(12) **United States Design Patent**
Davtian

(10) **Patent No.:** **US D734,128 S**
(45) **Date of Patent:** **** Jul. 14, 2015**

- (54) **TOWEL SECURING ACCESSORY**
- (71) Applicant: **Ruzanna Davtian**, Warwick, RI (US)
- (72) Inventor: **Ruzanna Davtian**, Warwick, RI (US)
- (**) Term: **14 Years**
- (21) Appl. No.: **29/460,657**
- (22) Filed: **Jul. 12, 2013**
- (51) **LOC (10) Cl.** **08-08**
- (52) **U.S. Cl.**
USPC **D8/349**; D6/608
- (58) **Field of Classification Search**
USPC D8/349, 354, 382, 388, 389, 391, 393;
D6/608; D21/255, 839, 840
CPC A47C 31/00; A47C 3/10; A47B 97/00;
A47G 9/06; A47G 9/062; A47G 7/025;
E04H 12/22; E04H 15/62; E04H 15/32;
E04H 15/12; E02D 5/80
See application file for complete search history.

5,579,798 A	12/1996	Pruitt	
D398,514 S	9/1998	Anderson	
D426,147 S *	6/2000	Nichols	D8/391
6,226,813 B1	5/2001	Wilburn et al.	
6,631,527 B2 *	10/2003	Hyduk	5/417
6,839,921 B2 *	1/2005	Cloutier et al.	5/417
6,938,384 B1	9/2005	Hodge	
7,472,874 B2	1/2009	Gross et al.	
D658,259 S	4/2012	Zhou et al.	
2008/0163915 A1 *	7/2008	Wobrock	135/118
2011/0244179 A1 *	10/2011	Strauwen	428/131

* cited by examiner

Primary Examiner — Thomas Johannes
Assistant Examiner — Shawn T Gingrich
(74) *Attorney, Agent, or Firm* — Salter & Michaelson

(57) **CLAIM**
The ornamental design for a towel securing accessory, as shown and described.

DESCRIPTION

FIG. 1 is a perspective view of a towel securing accessory; FIG. 2 is a top plan view thereof; FIG. 3 is a bottom plan view thereof; FIG. 4 is a front elevational view thereof; FIG. 5 is a rear elevational view thereof; FIG. 6 is a left side elevational view thereof; FIG. 7 is a right side elevational view thereof; and, FIG. 8 is an exploded perspective view thereof. The portions shown in broken lines are included for illustrative purposes only and form no part of the claimed design.

1 Claim, 6 Drawing Sheets

- (56) **References Cited**
U.S. PATENT DOCUMENTS
- | | | | |
|---------------|---------|------------------|---------|
| 2,647,718 A | 8/1953 | Disera | |
| 2,939,468 A * | 6/1960 | Boyce | 248/508 |
| D299,006 S * | 12/1988 | Mednick | D8/388 |
| 5,101,525 A | 4/1992 | Ippolito | |
| 5,176,354 A | 1/1993 | Feigenbaum, Jr. | |
| 5,524,309 A * | 6/1996 | La Barbera | 5/658 |
| D377,076 S * | 12/1996 | Adams | D21/840 |

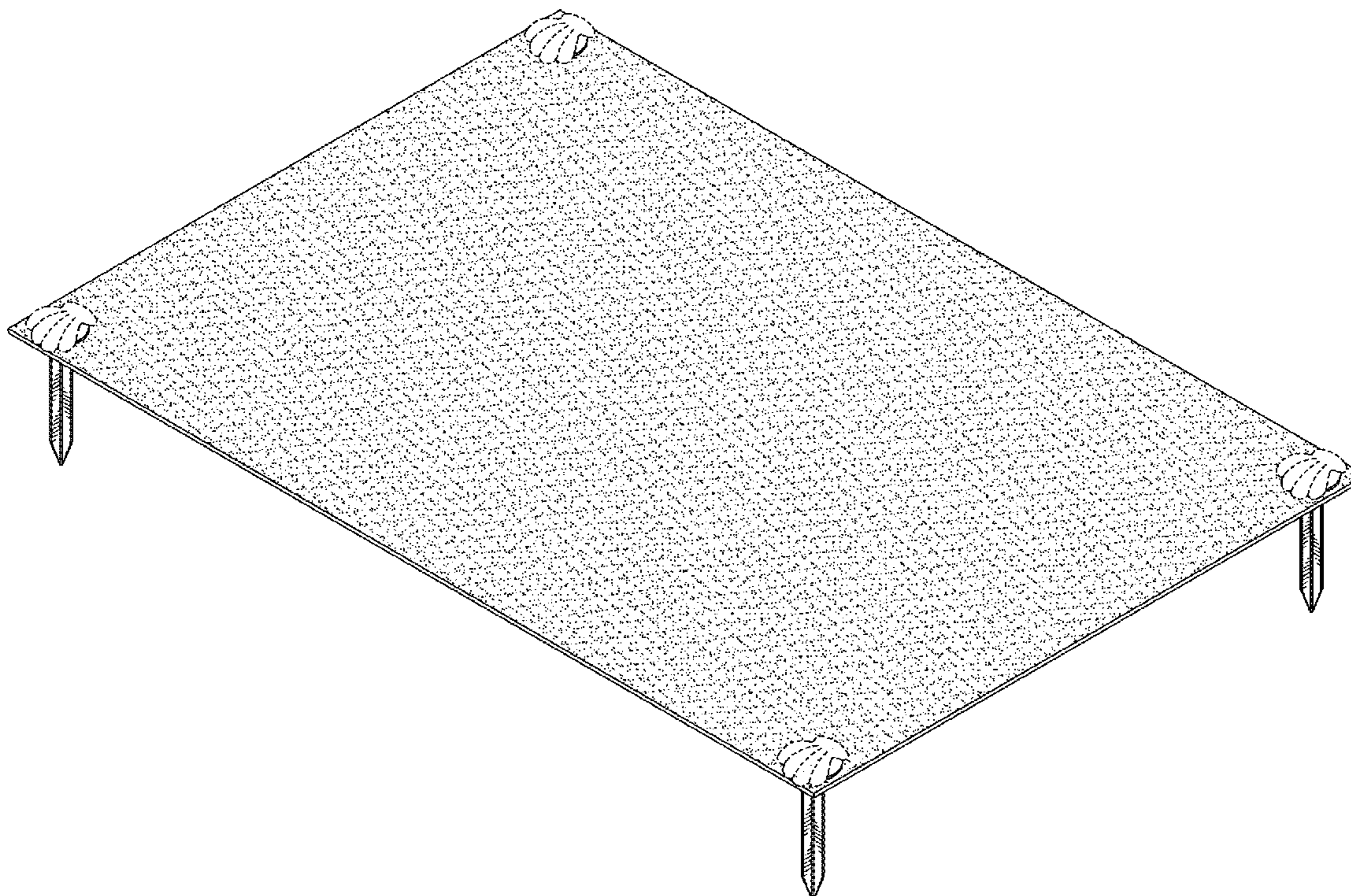

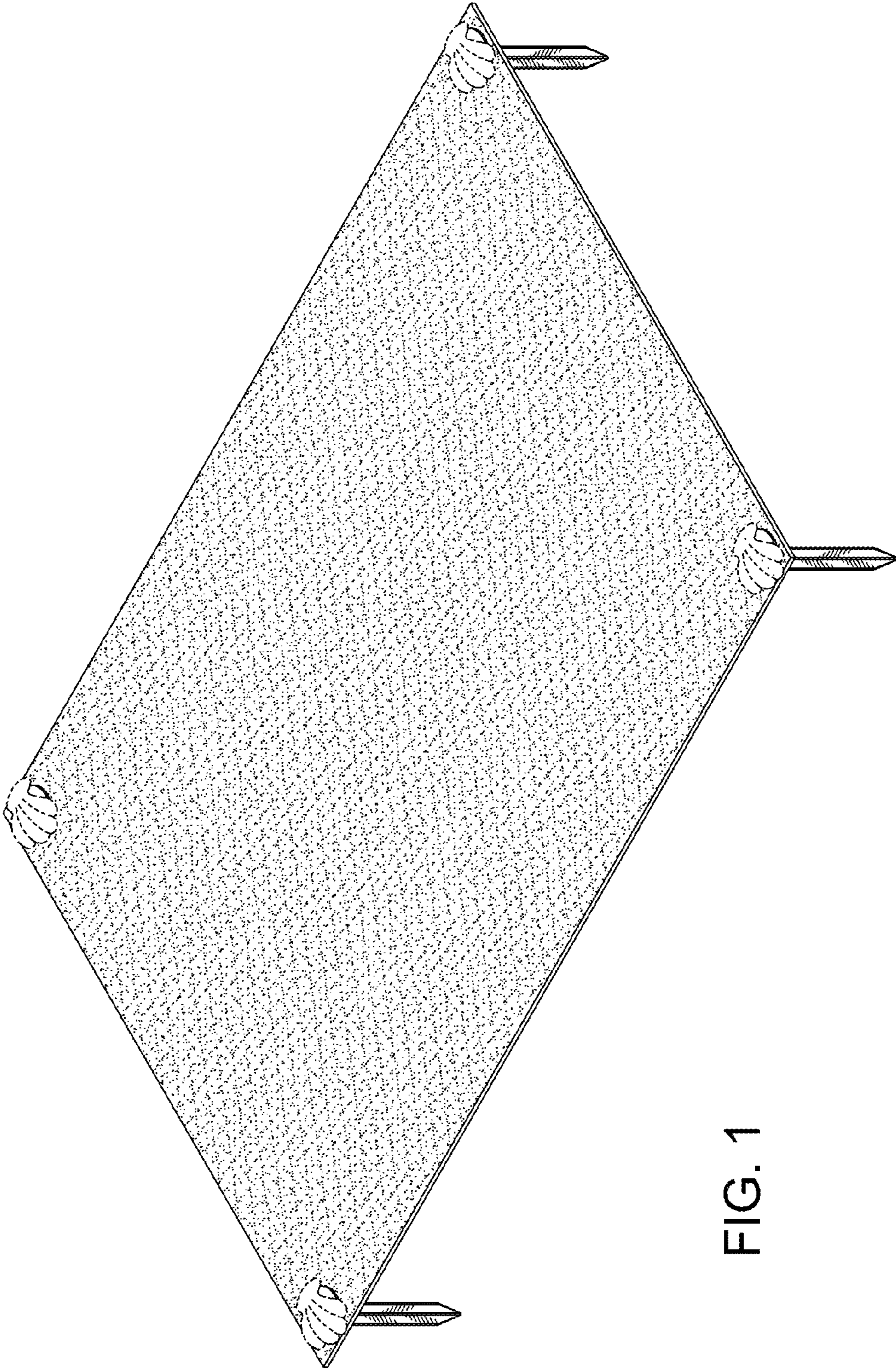

FIG. 1

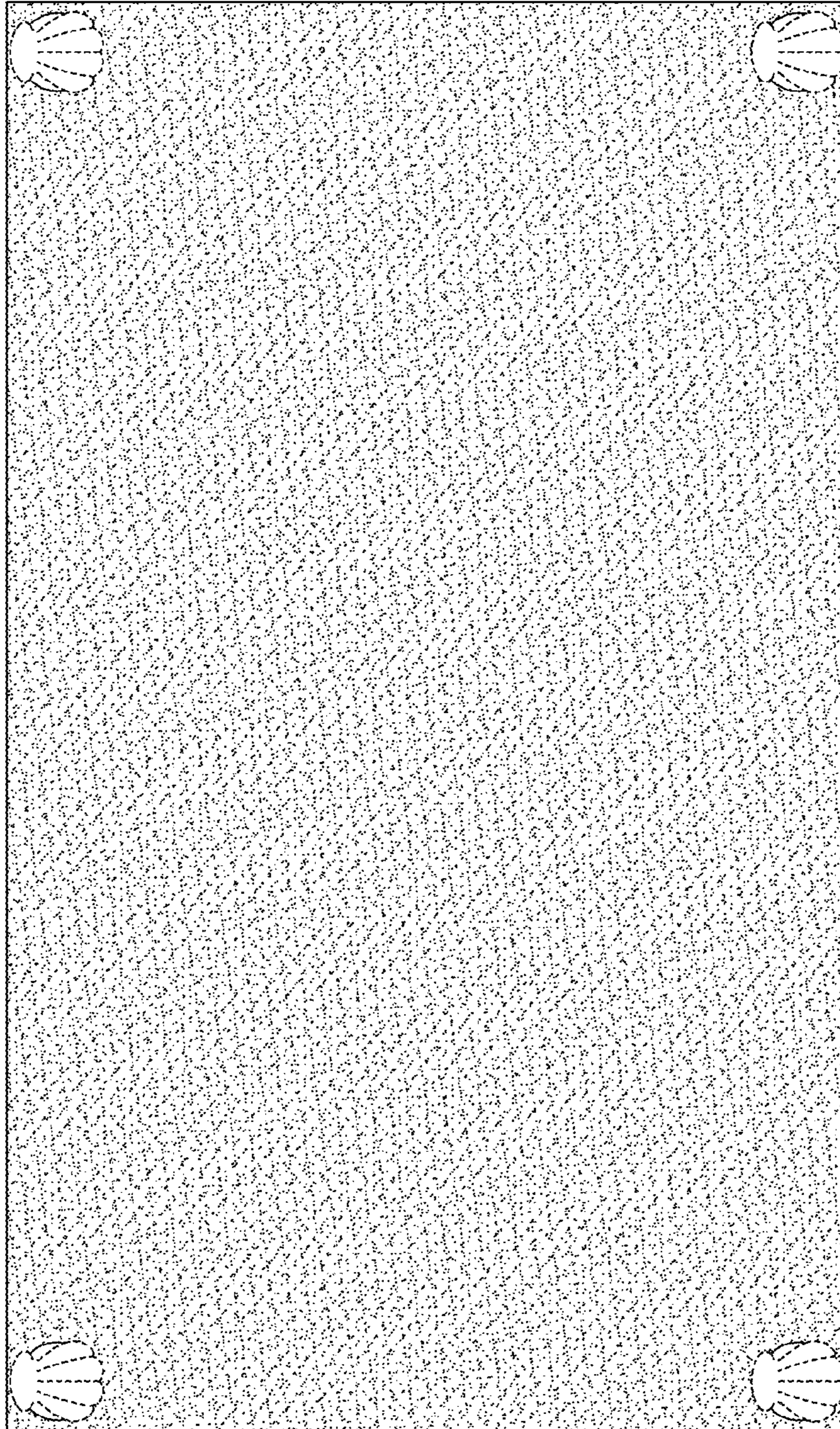

FIG. 2

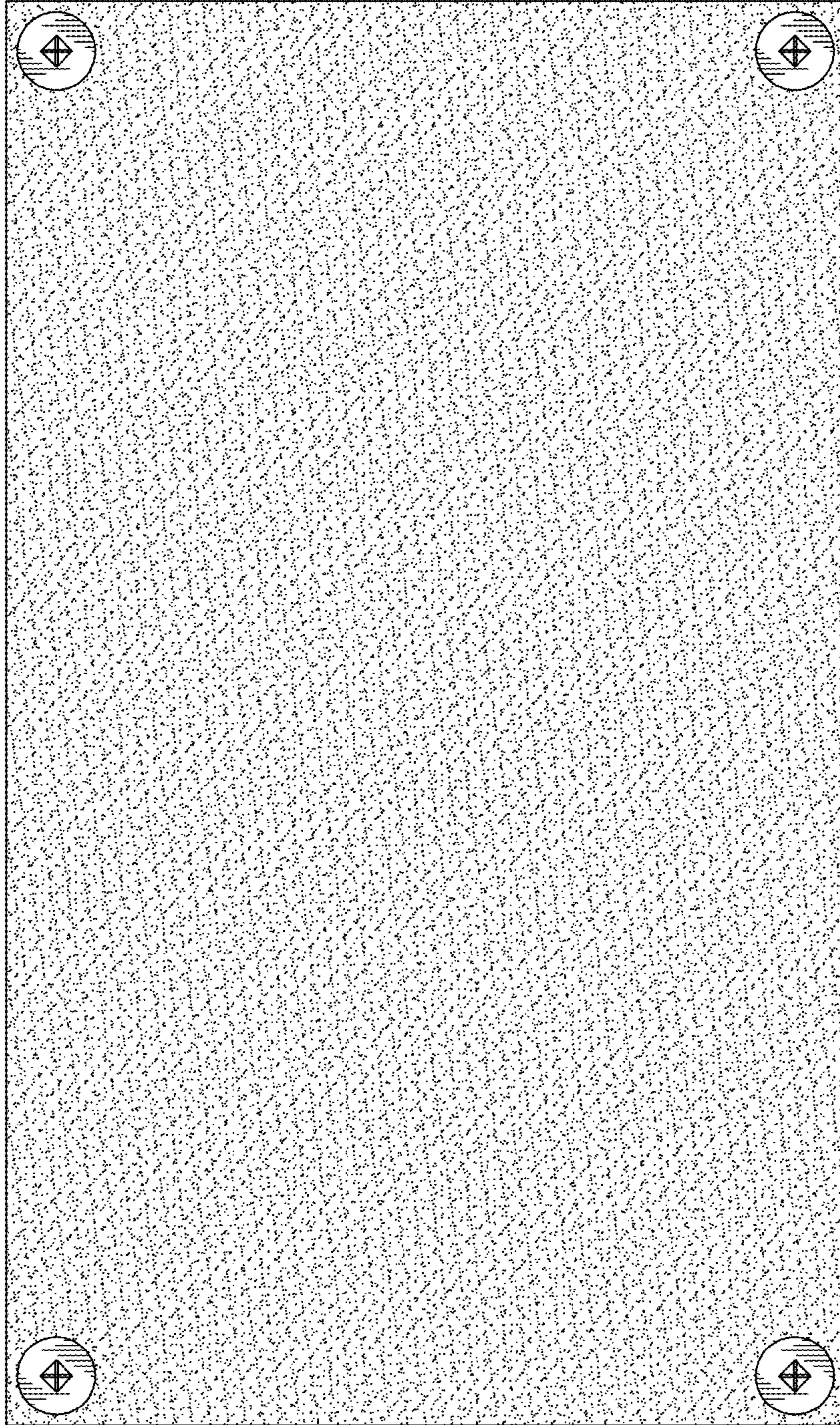

FIG. 3

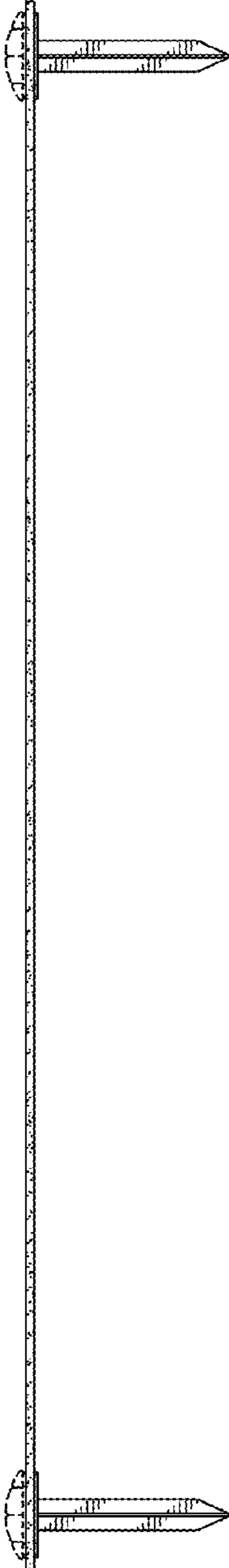

FIG. 4

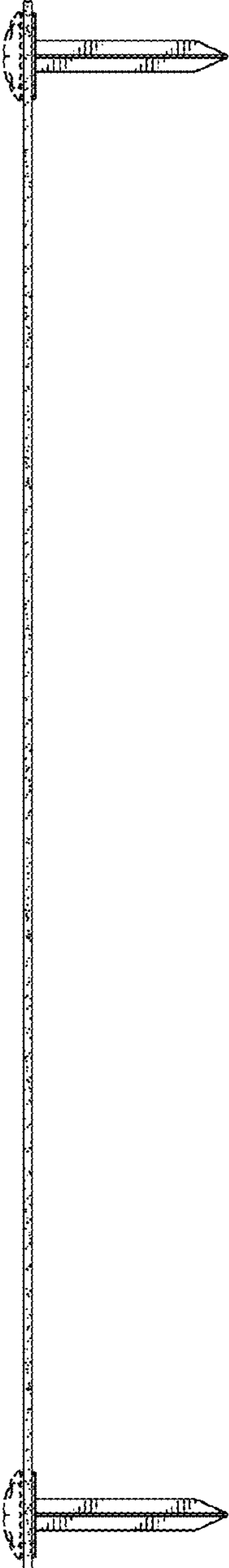

FIG. 5

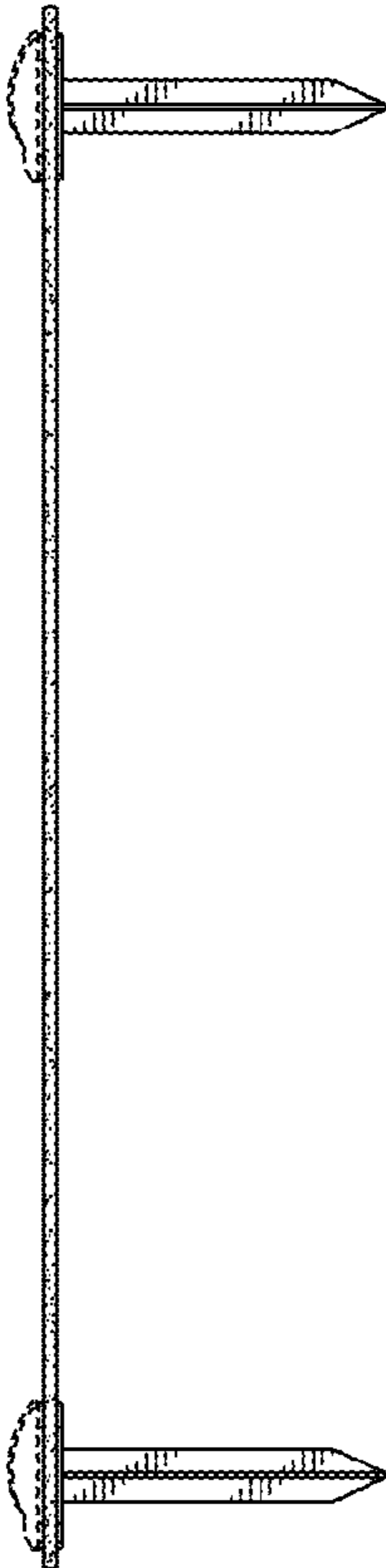

FIG. 6

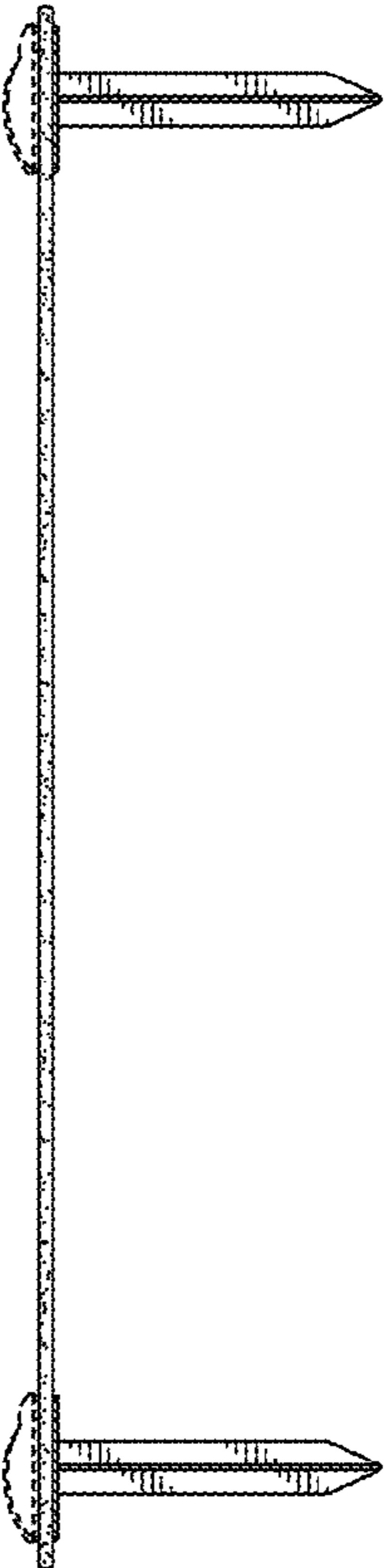

FIG. 7

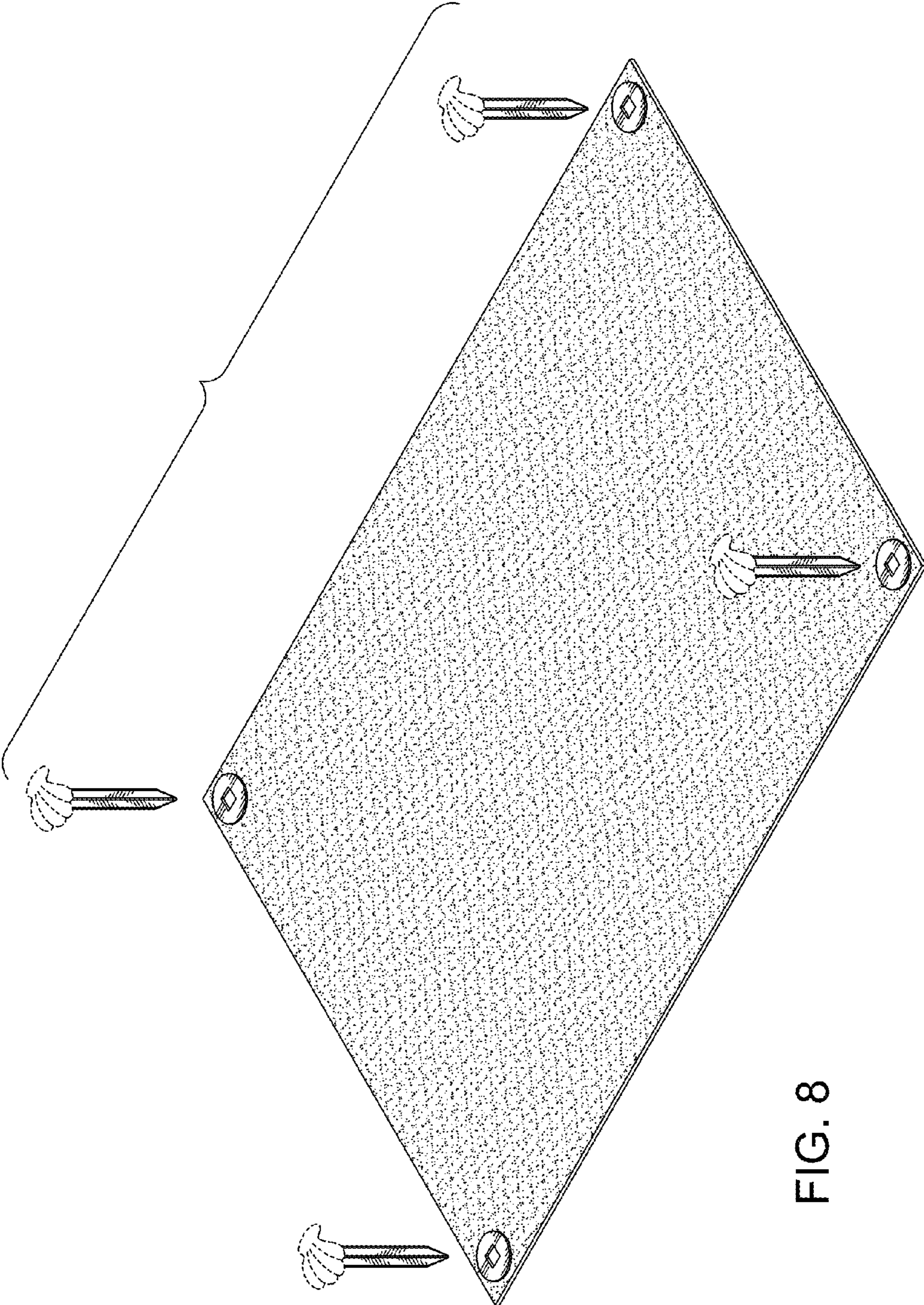

FIG. 8