



US00D734121S

(12) **United States Design Patent**  
**Schneider et al.**

(10) **Patent No.:** **US D734,121 S**  
(45) **Date of Patent:** **\*\* Jul. 14, 2015**

(54) **LEVER**

(71) Applicant: **KWIKSET CORPORATION**, Lake Forest, CA (US)

(72) Inventors: **Elliott Barlow Schneider**, Foothill Ranch, CA (US); **Yos Singtoroj**, Anaheim, CA (US)

(73) Assignee: **Kwikset Corporation**, Lake Forest, CA (US)

(\*\*) Term: **14 Years**

(21) Appl. No.: **29/488,291**

(22) Filed: **Apr. 17, 2014**

(51) **LOC (10) Cl.** ..... **08-06**

(52) **U.S. Cl.**  
USPC ..... **D8/308**

(58) **Field of Classification Search**  
USPC ..... D8/300-302, 307-309, 310, 311,  
D8/DIG. 10; D23/250, 252; 292/336.3;  
74/523, 543; 70/192, 201, 206, 207;  
16/110.1, 412, 416, DIG. 30

See application file for complete search history.

(56) **References Cited**

U.S. PATENT DOCUMENTS

|          |   |   |        |                |       |         |
|----------|---|---|--------|----------------|-------|---------|
| D264,932 | S | * | 6/1982 | Miller et al.  | ..... | D8/315  |
| D509,422 | S | * | 9/2005 | Gehry          | ..... | D8/300  |
| D549,545 | S | * | 8/2007 | Schneider      | ..... | D8/308  |
| D577,566 | S | * | 9/2008 | Grohmann       | ..... | D8/308  |
| D645,942 | S | * | 9/2011 | Flowers et al. | ..... | D23/250 |
| D713,710 | S | * | 9/2014 | Roberts, III   | ..... | D8/308  |
| D714,426 | S | * | 9/2014 | Kulig          | ..... | D23/252 |

\* cited by examiner

*Primary Examiner* — Derrick Holland

*Assistant Examiner* — Lauren Calve

(74) *Attorney, Agent, or Firm* — Barnes & Thornburg LLP

(57) **CLAIM**

What is claimed is the ornamental design for a lever, as shown and described.

**DESCRIPTION**

FIG. 1 is a perspective view of a lever of the new design; FIG. 2 is a right side view thereof; FIG. 3 is a left side view thereof; FIG. 4 is a top view thereof; FIG. 5 is a bottom view thereof; FIG. 6 is a front view thereof; and, FIG. 7 is a back view thereof. The broken lines shown represent unclaimed subject matter and form no part of the claimed design.

**1 Claim, 5 Drawing Sheets**

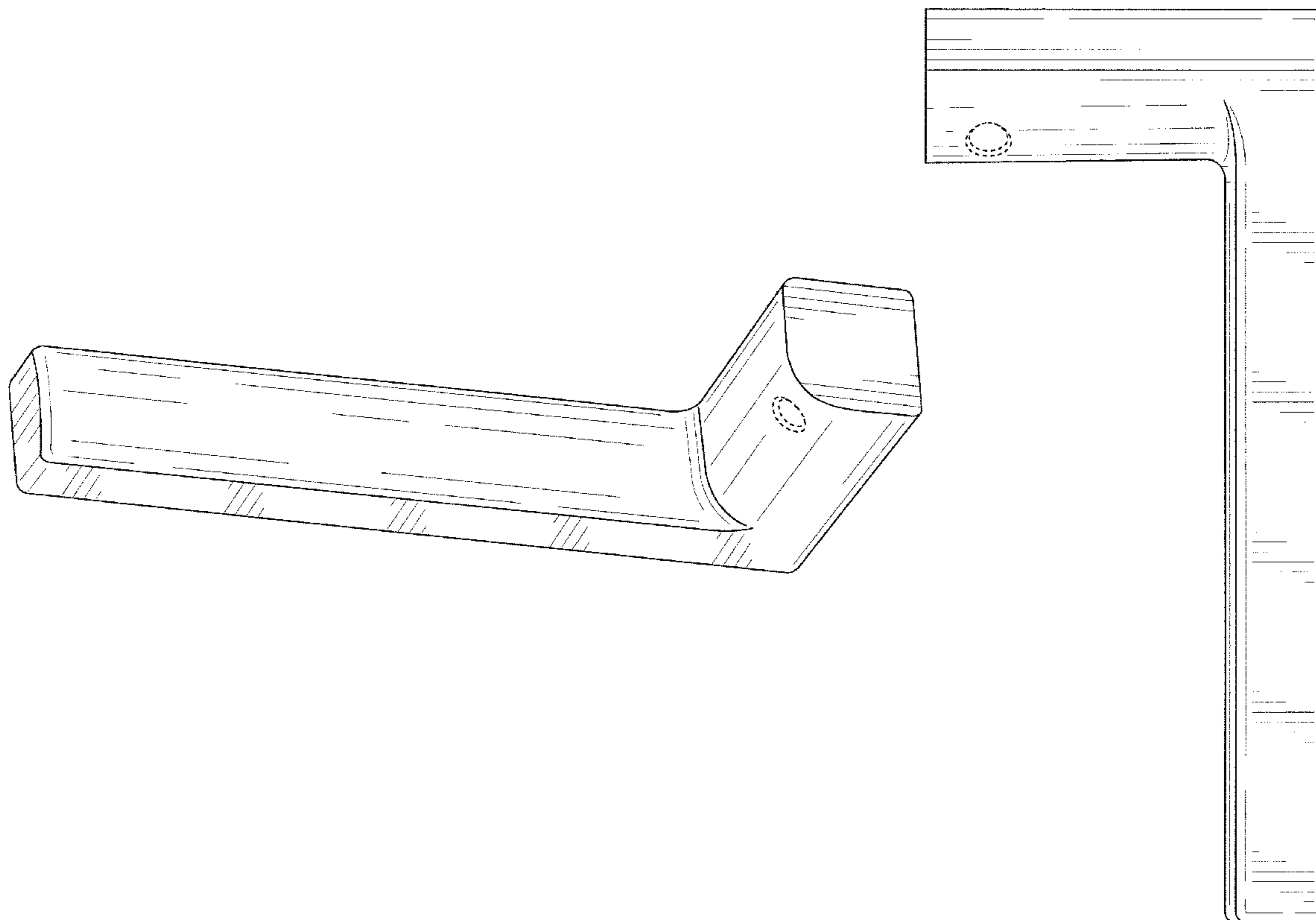

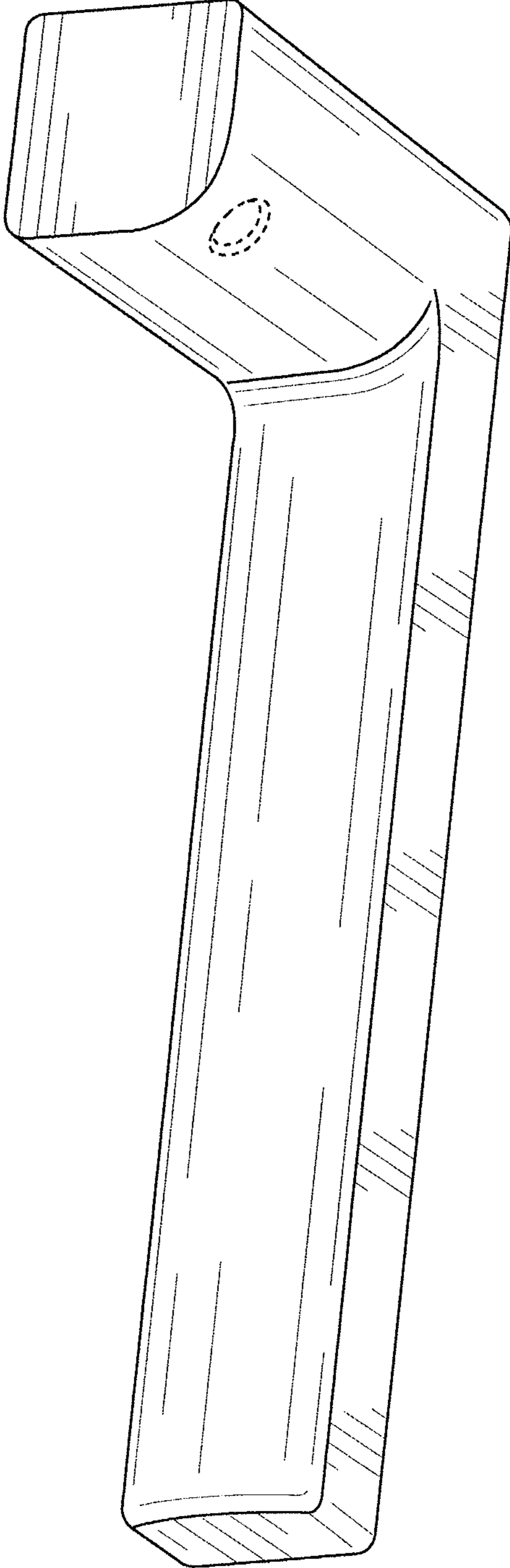
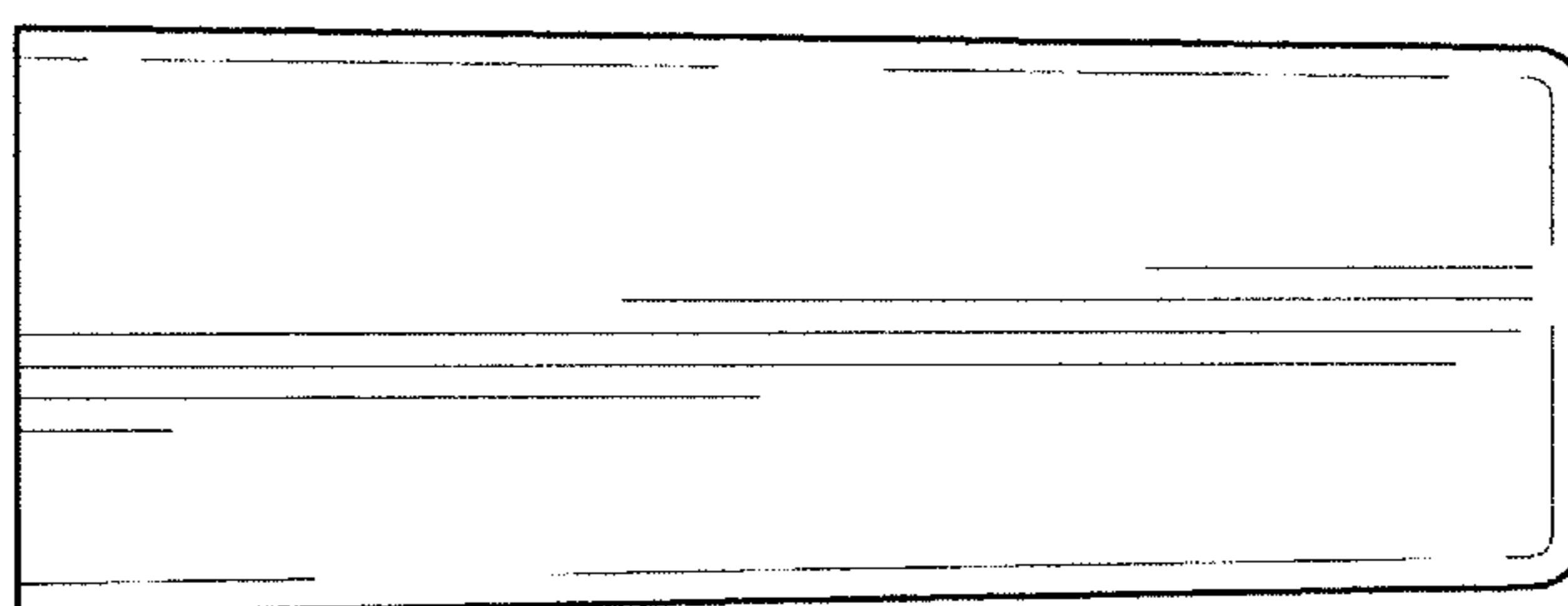
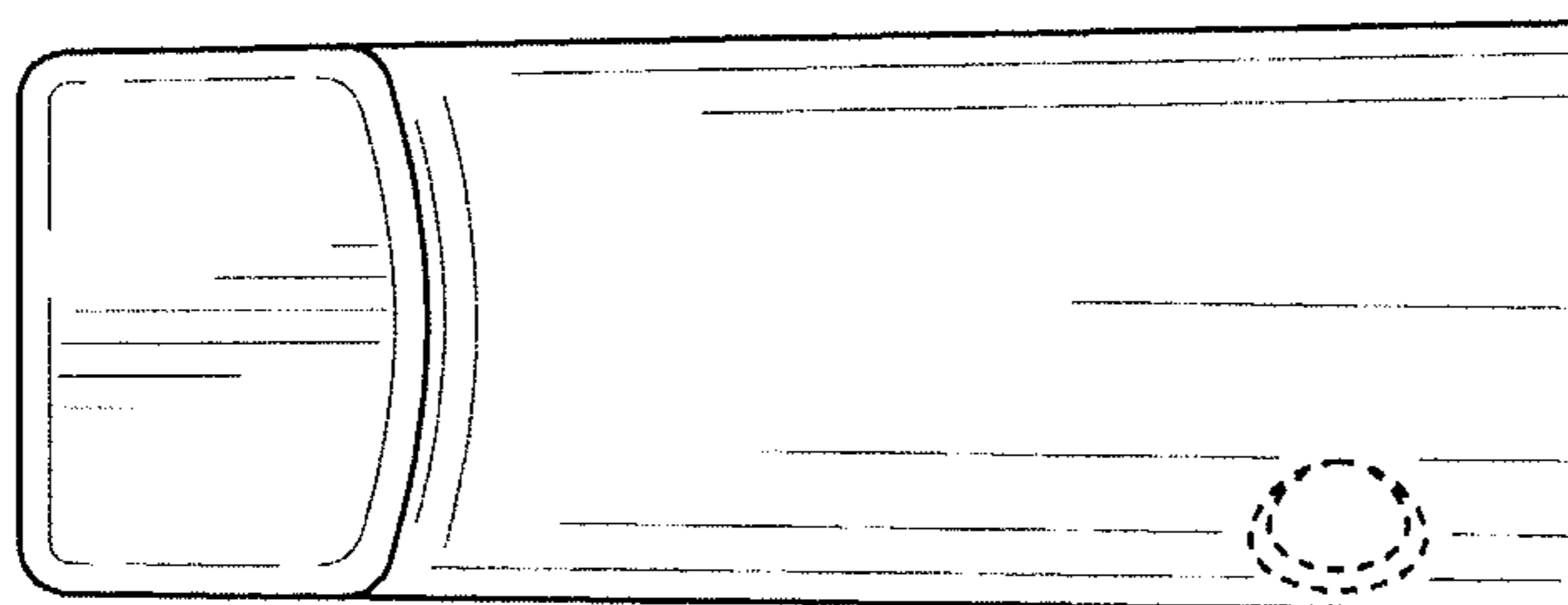

FIG. 1



**FIG. 2**



**FIG. 3**

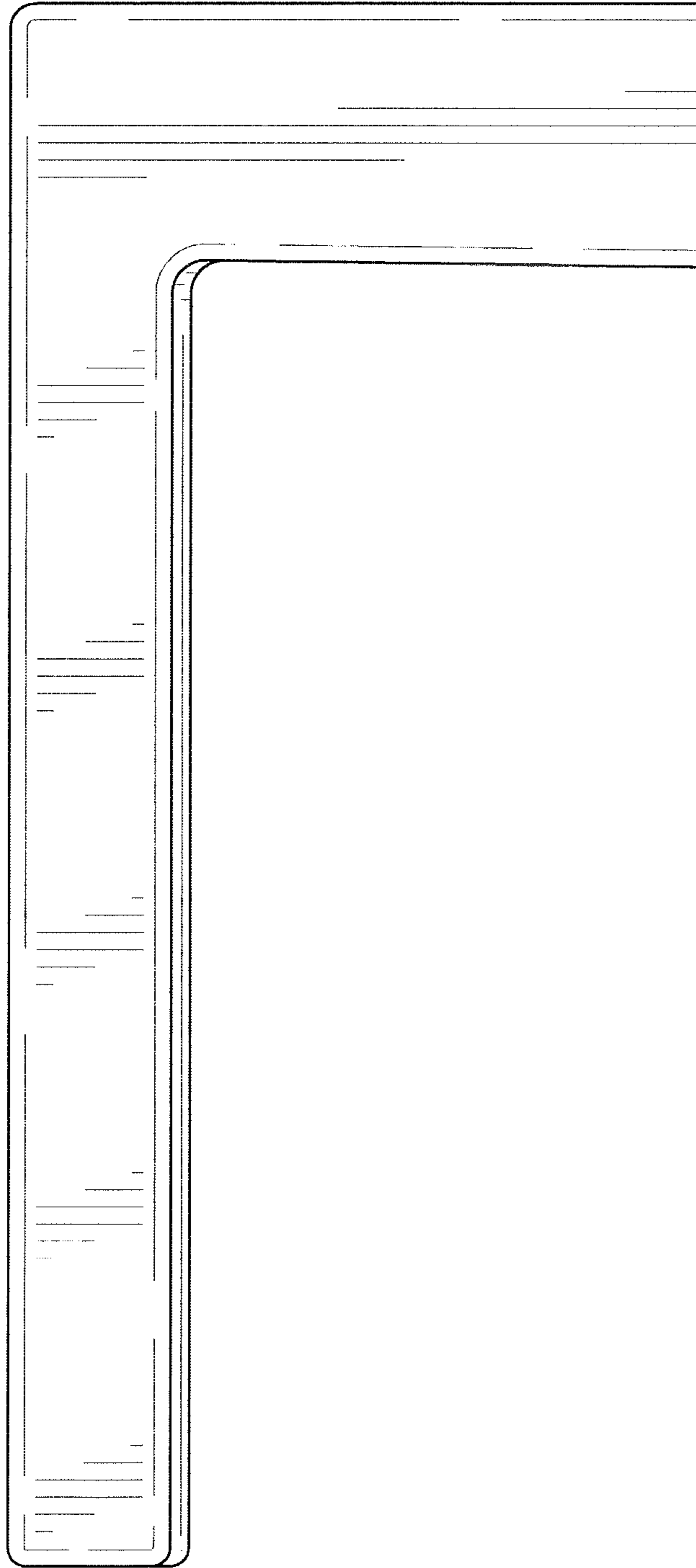

**FIG. 4**

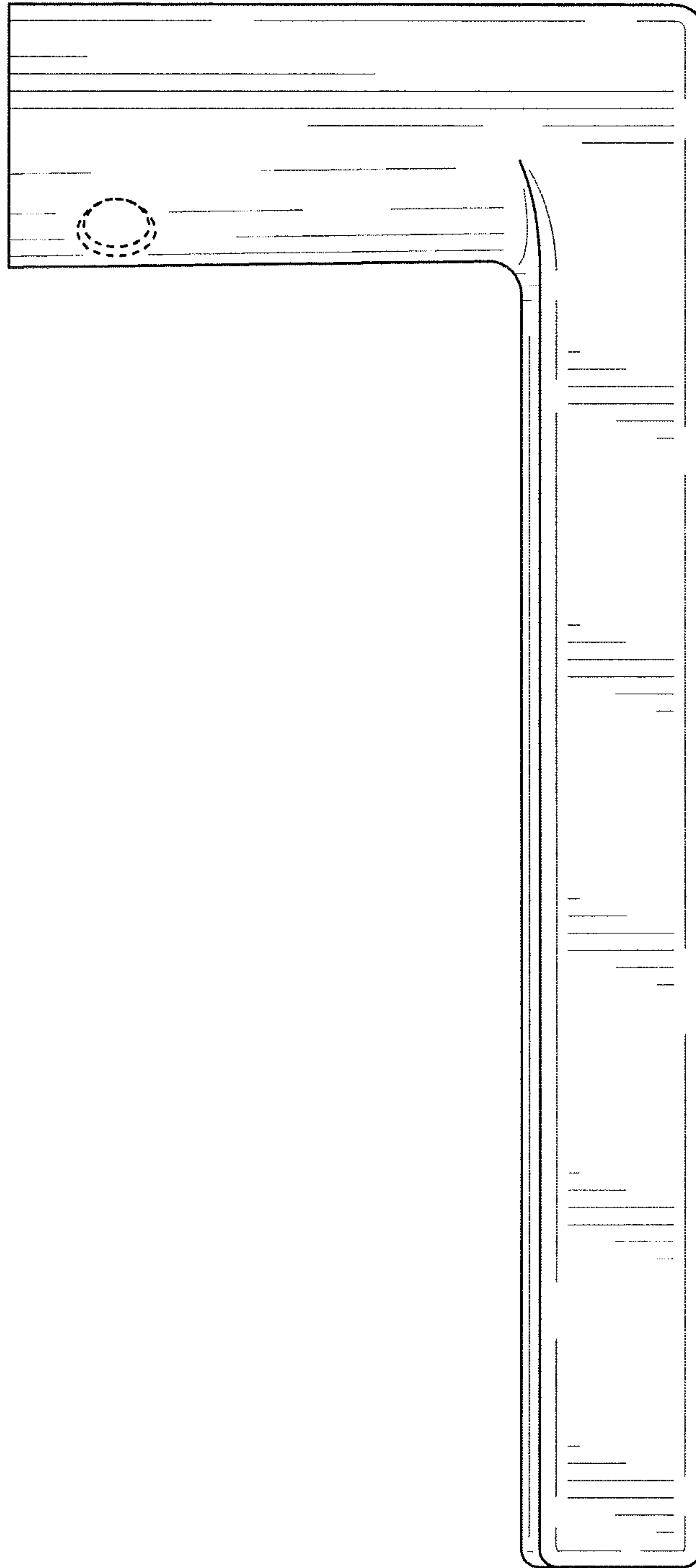
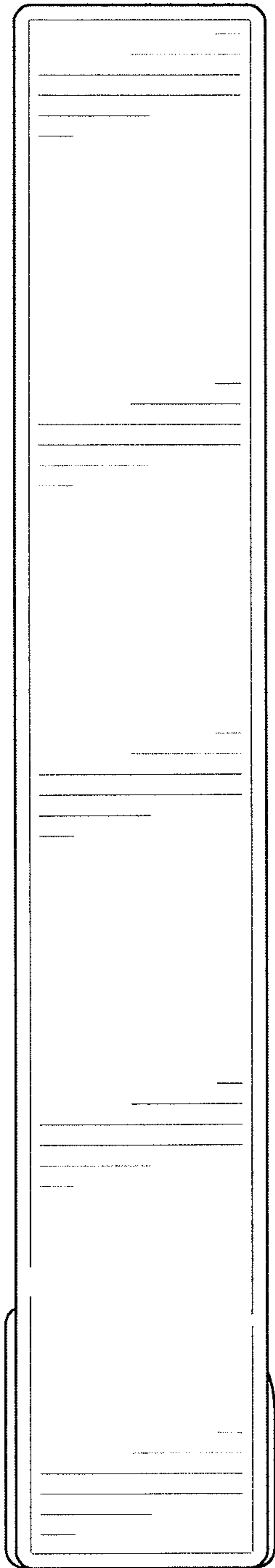
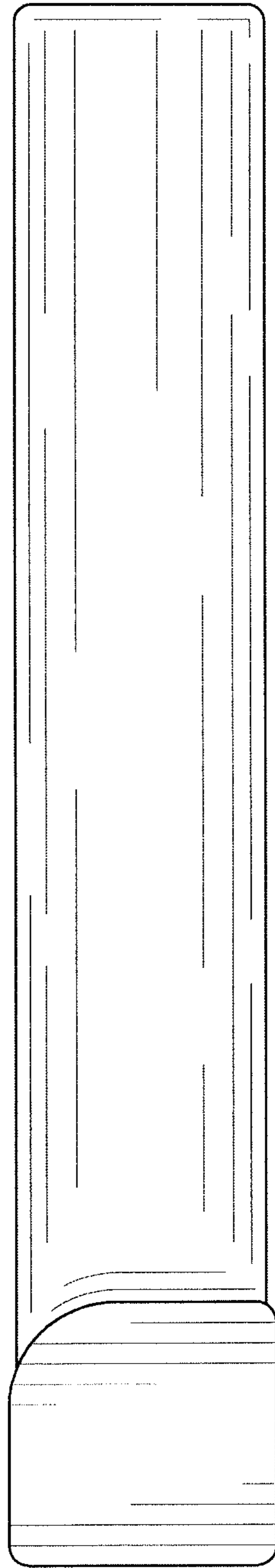

FIG. 5



**FIG. 6**



**FIG. 7**