



US00D734093S

(12) **United States Design Patent**
Munari

(10) **Patent No.:** **US D734,093 S**
(45) **Date of Patent:** **** Jul. 14, 2015**

(54) **KNOB FOR COOKING UTENSILS AND APPARATUS**

(71) Applicant: **LA TERMOPLASTIC F.B.M. S.R.L.**,
Arsago Seprio (VA) (IT)
(72) Inventor: **Marco Munari**, Cardano Al Campo (IT)
(73) Assignee: **LA TERMOPLASTIC F.B.M. S.R.L.**,
Arsago Seprio (VA) (IT)

(**) Term: **14 Years**
(21) Appl. No.: **29/497,906**
(22) Filed: **Jul. 29, 2014**

(30) **Foreign Application Priority Data**

Jan. 30, 2014 (EM) 002395426-0003

(51) **LOC (10) Cl.** **07-02**

(52) **U.S. Cl.**
USPC **D7/393**

(58) **Field of Classification Search**
USPC D7/354-358, 395-361, 391, 393, 402,
D7/405, 406, 682; D8/107, 307, 300, 310,
D8/311, 314; D23/250, 252; 16/110 R,
16/114 R, 118, 121, 309, 311, 312, 315,
16/320, 430, 431, 441; 74/548, 553,
74/558.5; 200/18, 61.8, 336-338,
200/564-570; 220/573.1-573.5, 752, 753,
220/755, 912
CPC A47J 45/063; A47J 45/074

See application file for complete search history.

(56) **References Cited**

U.S. PATENT DOCUMENTS

D127,735 S *	6/1941	Dreyfuss	D23/250
D143,287 S *	12/1945	Dreyfuss	D23/250
D145,607 S *	9/1946	Zinkil	D23/250
D187,412 S *	3/1960	Young	D23/250
D252,208 S *	6/1979	Ooya	D8/312
D269,409 S *	6/1983	Ferdinand et al.	D8/307
D609,550 S *	2/2010	Wan et al.	D8/307
D697,591 S *	1/2014	Boeltl et al.	D23/252

* cited by examiner

Primary Examiner — Cynthia M Chin

(74) *Attorney, Agent, or Firm* — Hedman & Costigan, P.C.;
James V. Costigan; Kathleen A. Costigan

(57) **CLAIM**

I claim the ornamental design for a knob for cooking utensils and apparatus, as shown and described.

DESCRIPTION

FIG. 1 is a top perspective view of a knob for cooking utensils and apparatus having a grip comprised of three main elements joined at the center of the top of the knob according to the present invention;

FIG. 2 is a bottom, perspective view thereof;

FIG. 3 is a side elevational view thereof, taken at one of the three main elements, each main element affording the identical view when viewed at 120° intervals around the perimeter of the knob;

FIG. 4 is a side perspective view showing two of the three main elements of the knob;

FIG. 5 is an additional side perspective view showing two of the three main elements of the knob;

FIG. 6 is top plan view thereof; and,

FIG. 7 is a bottom plan view thereof.

1 Claim, 2 Drawing Sheets

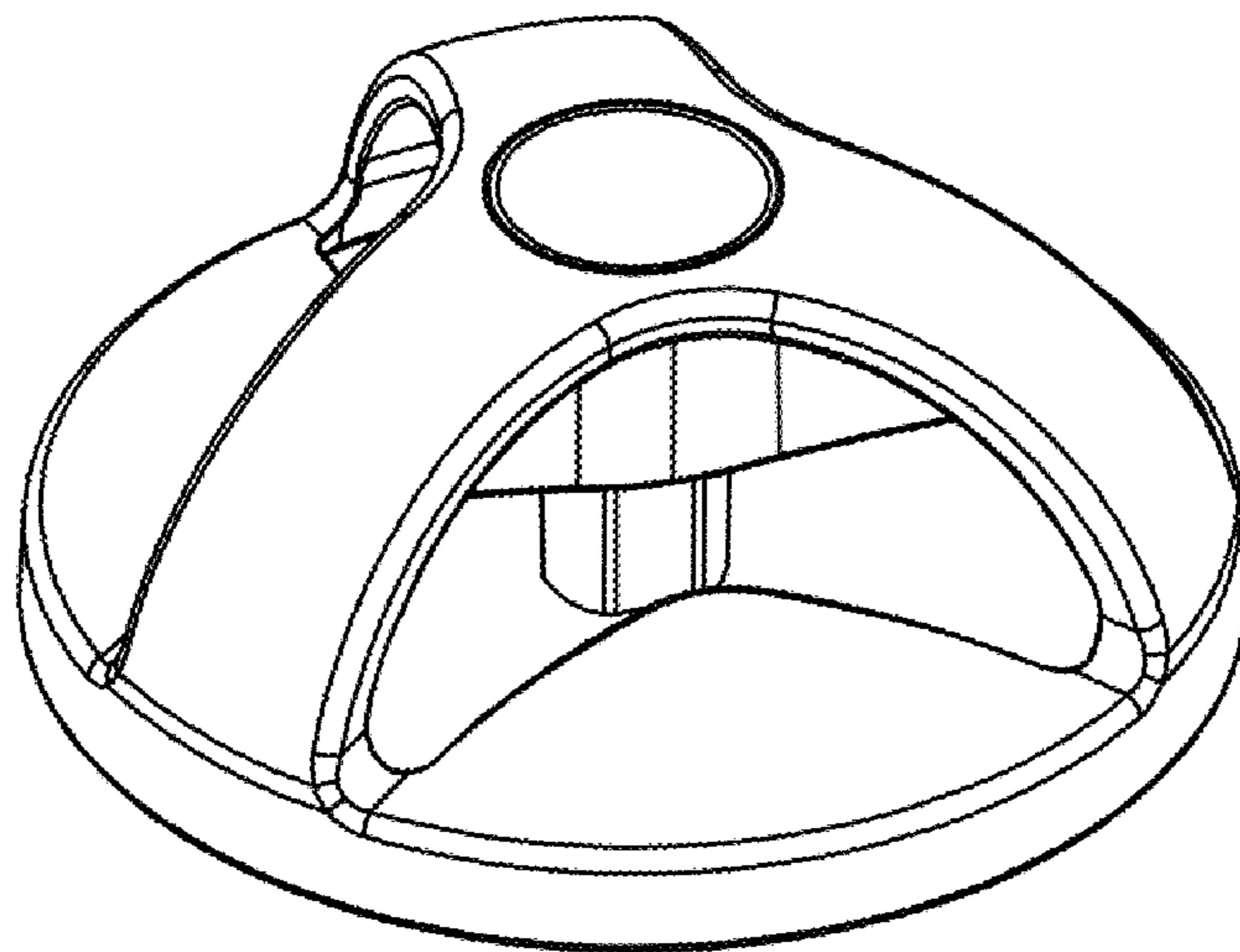

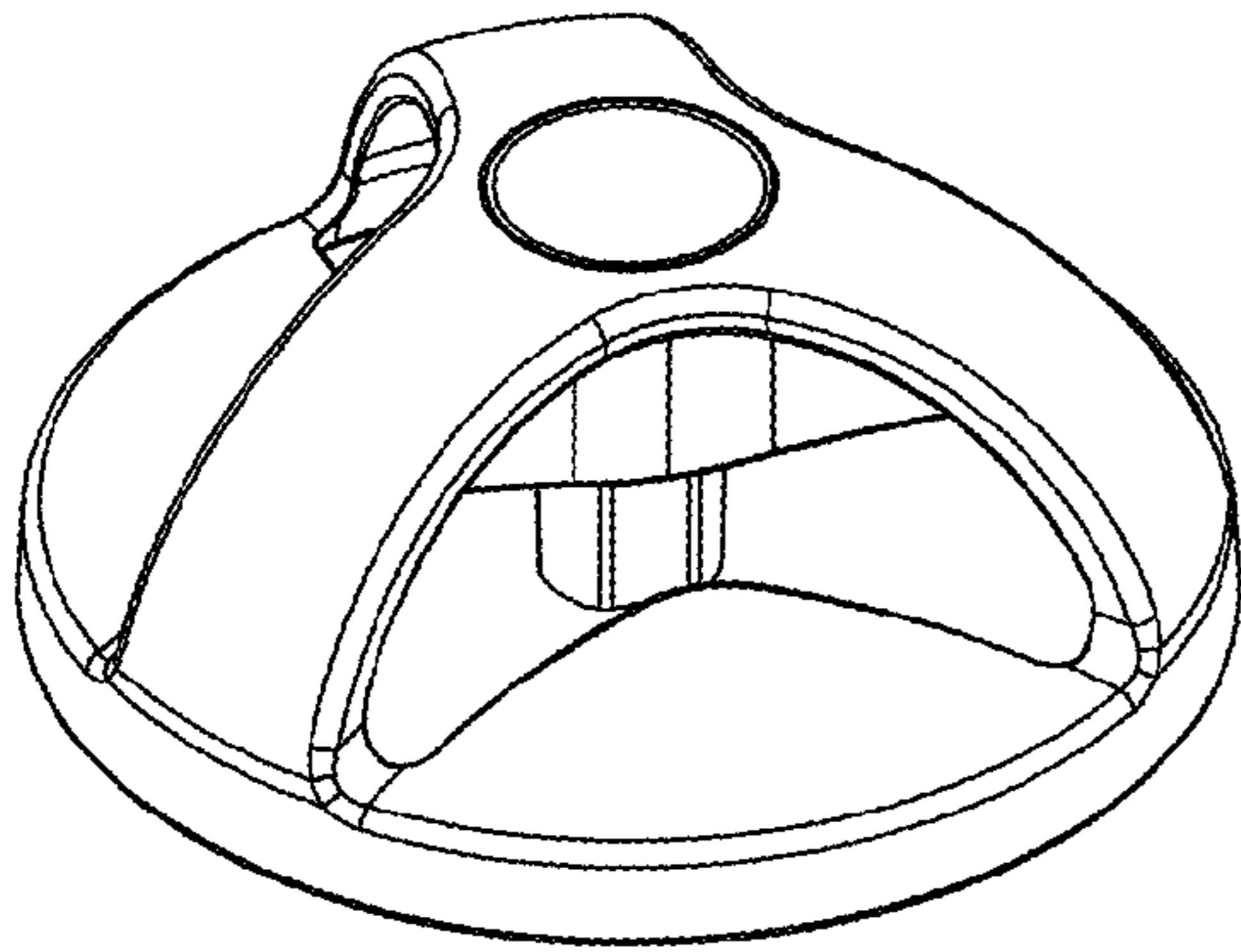

Fig. 1

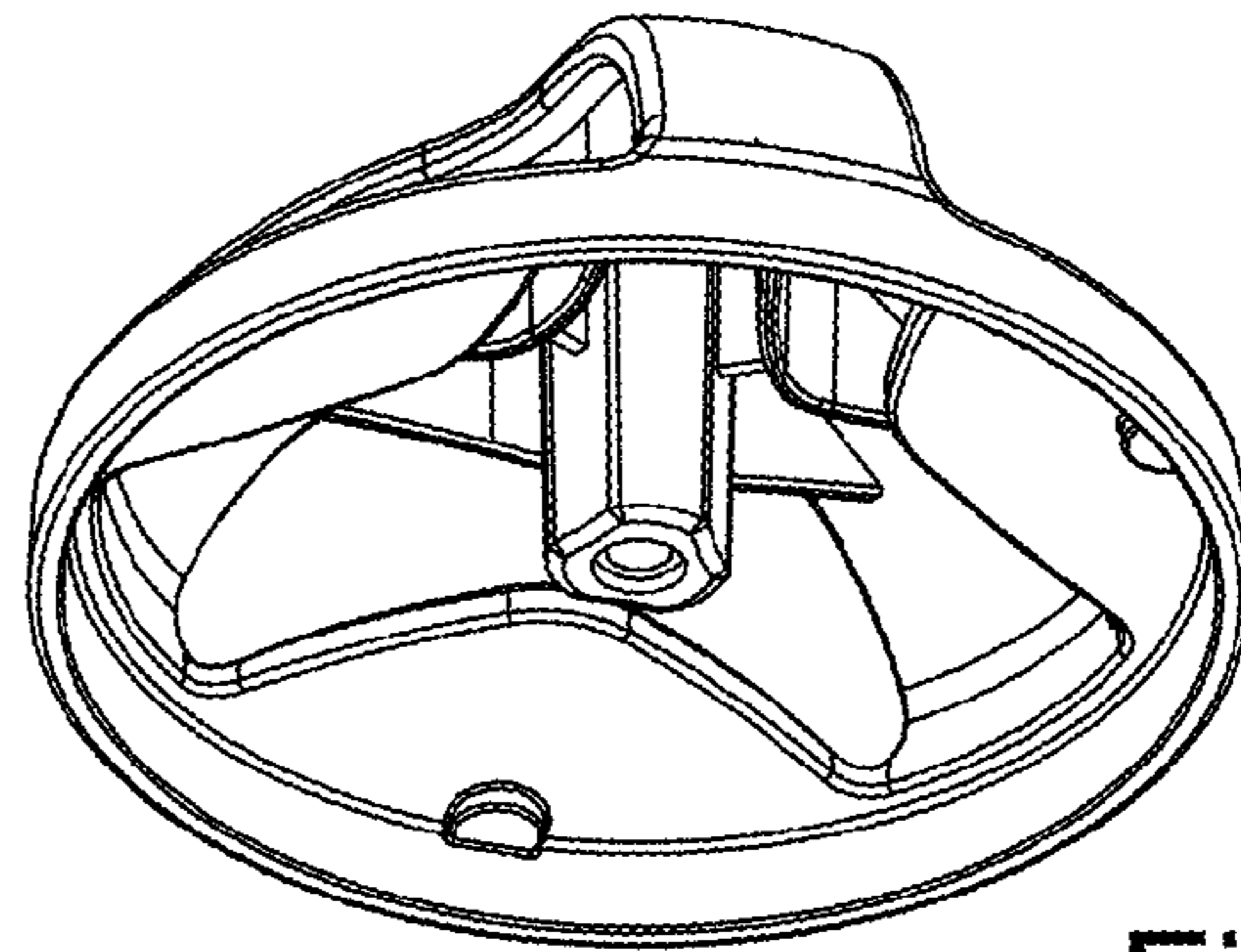

Fig. 2

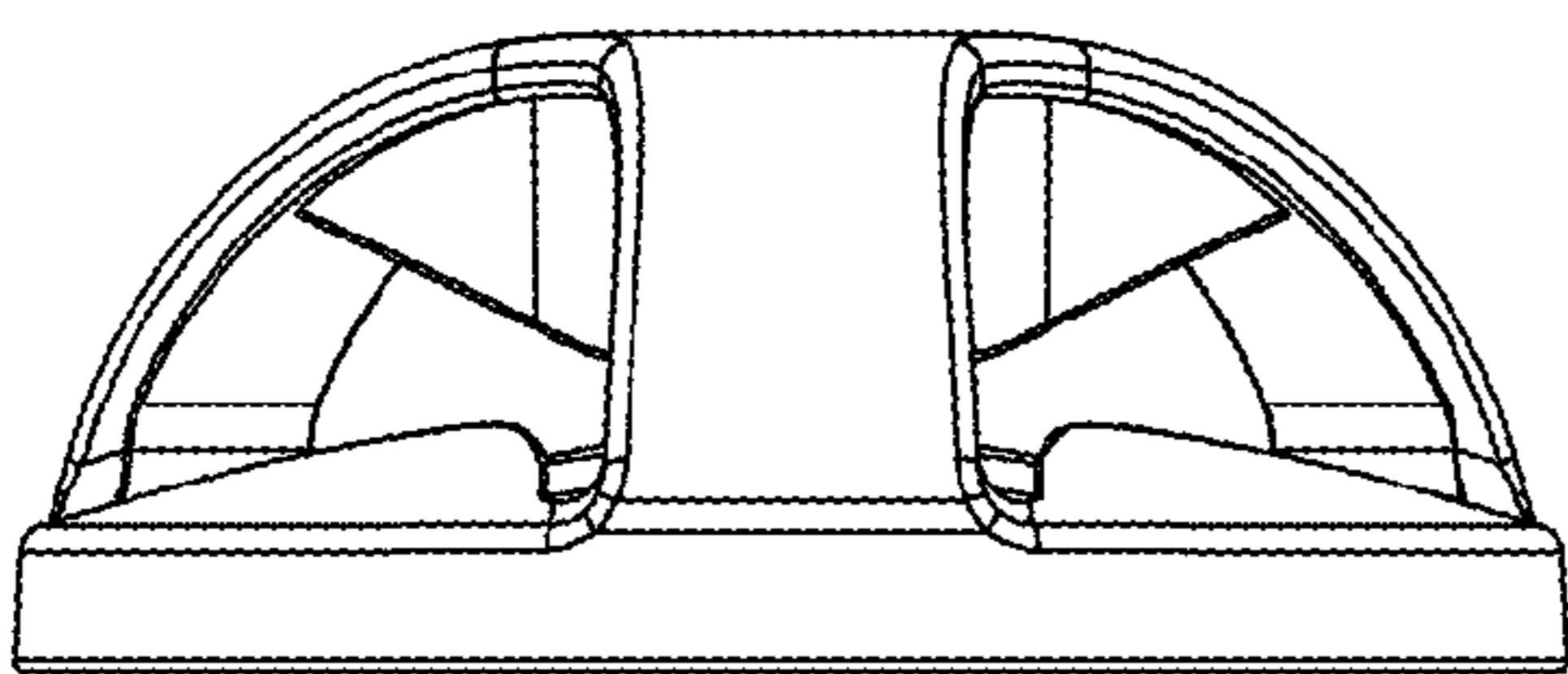

Fig. 3

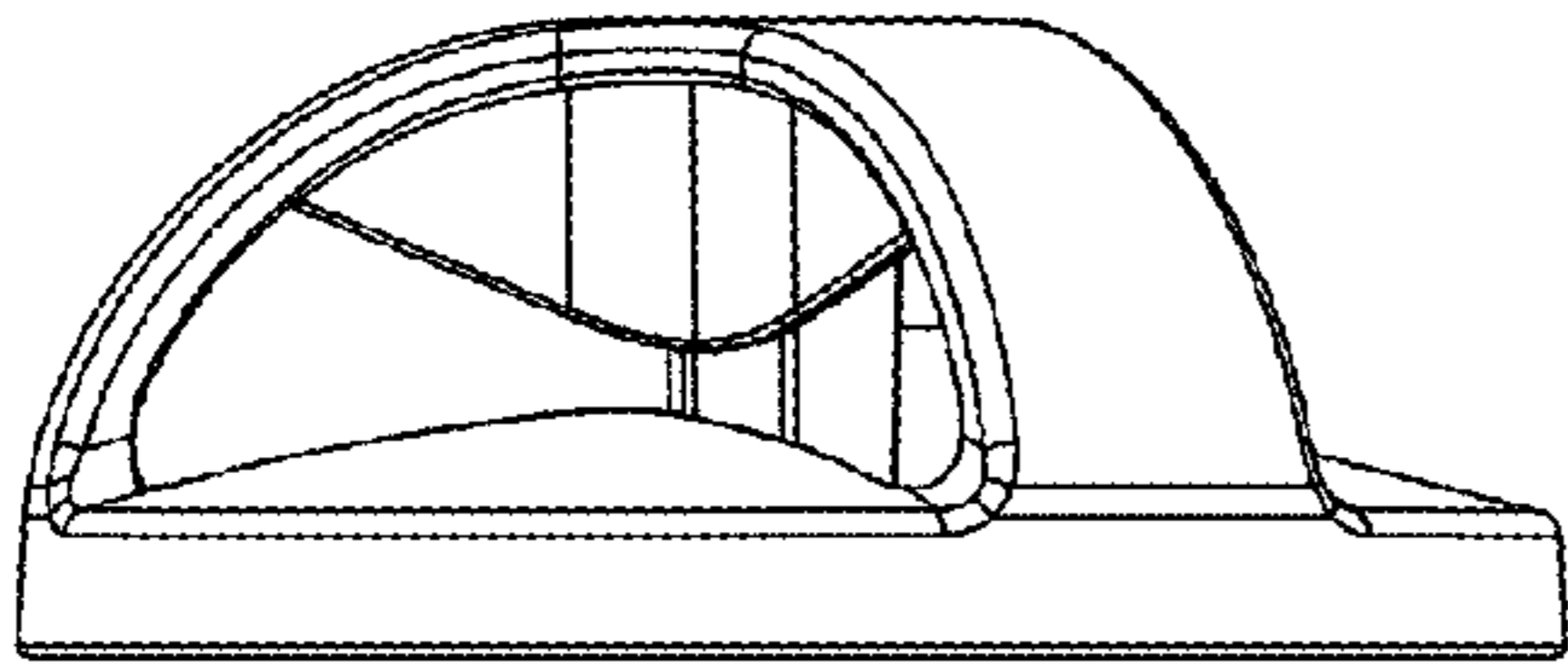

Fig. 4

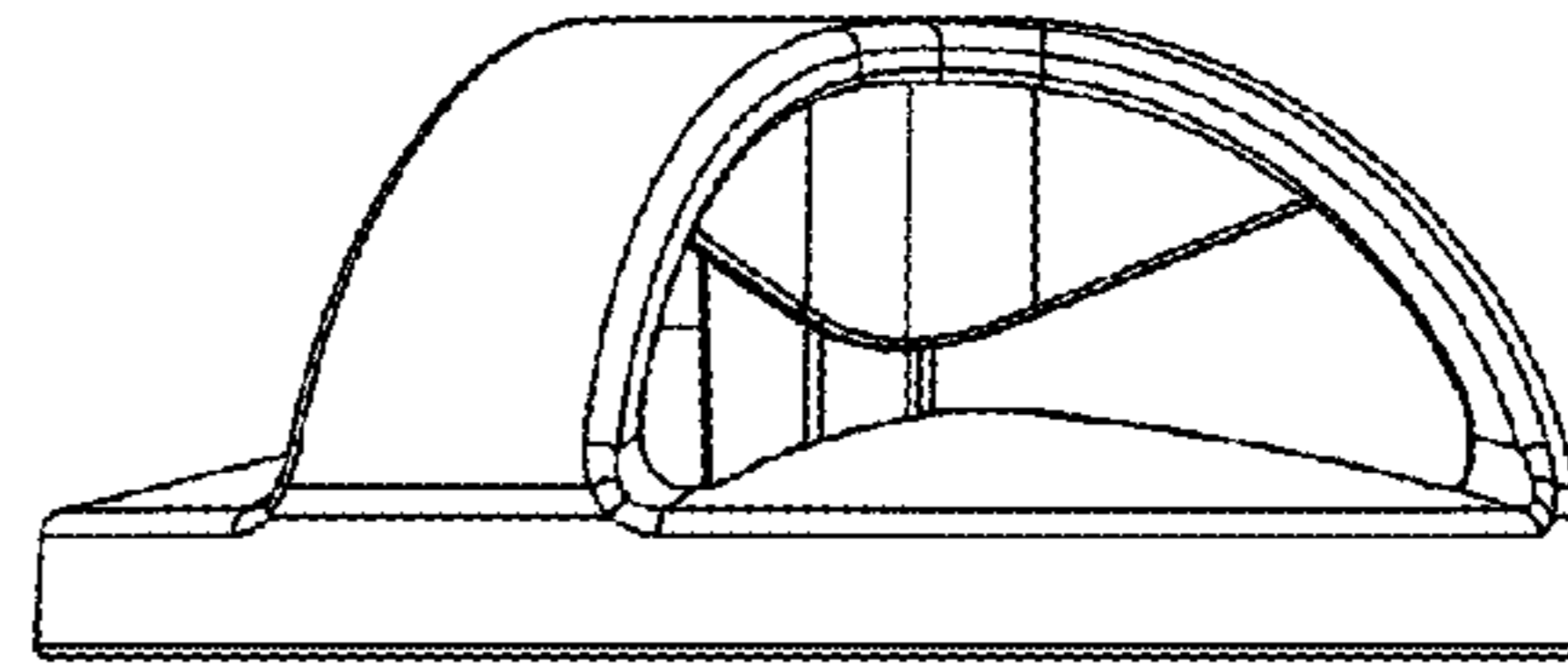

Fig. 5

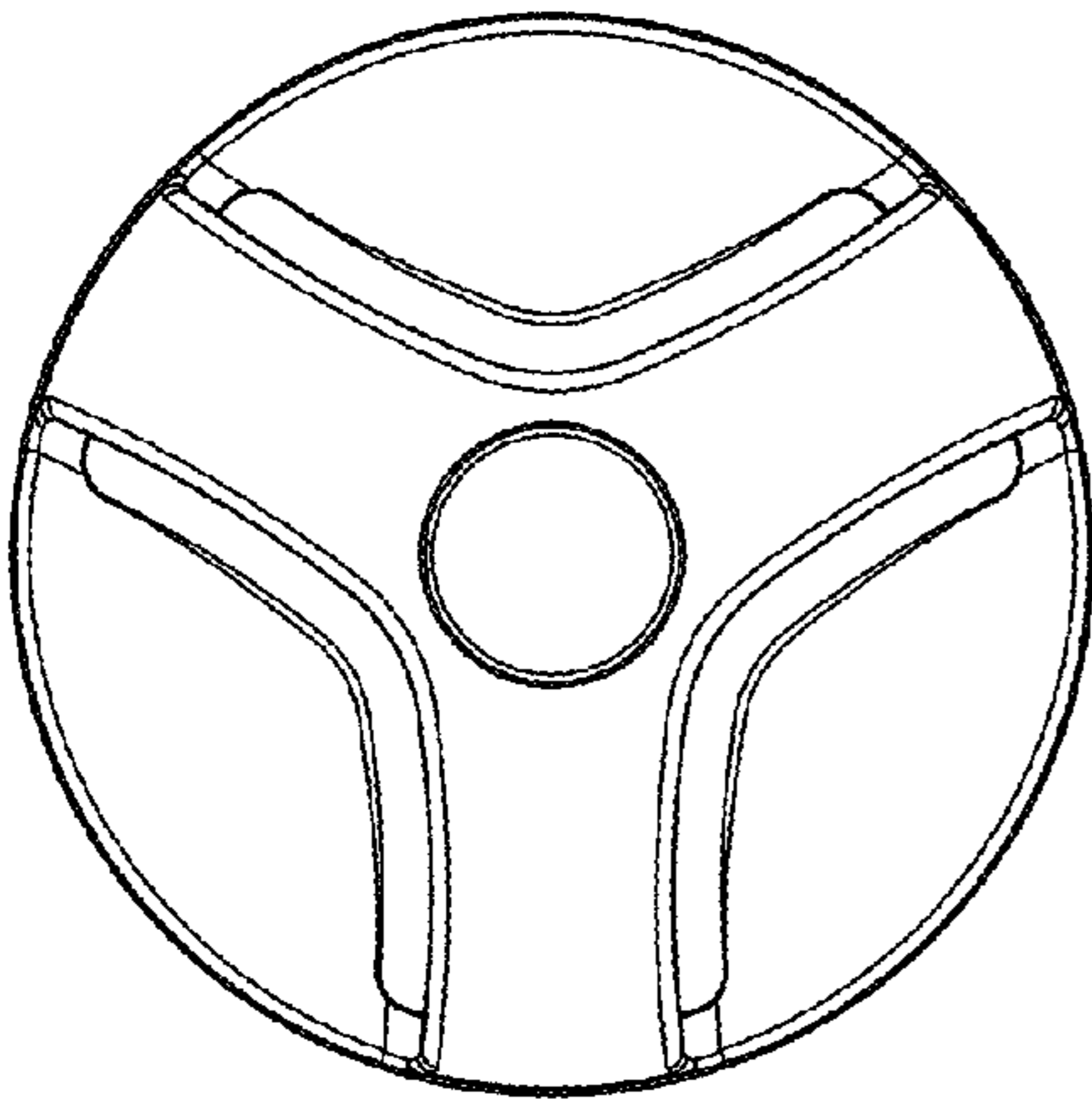

Fig. 6

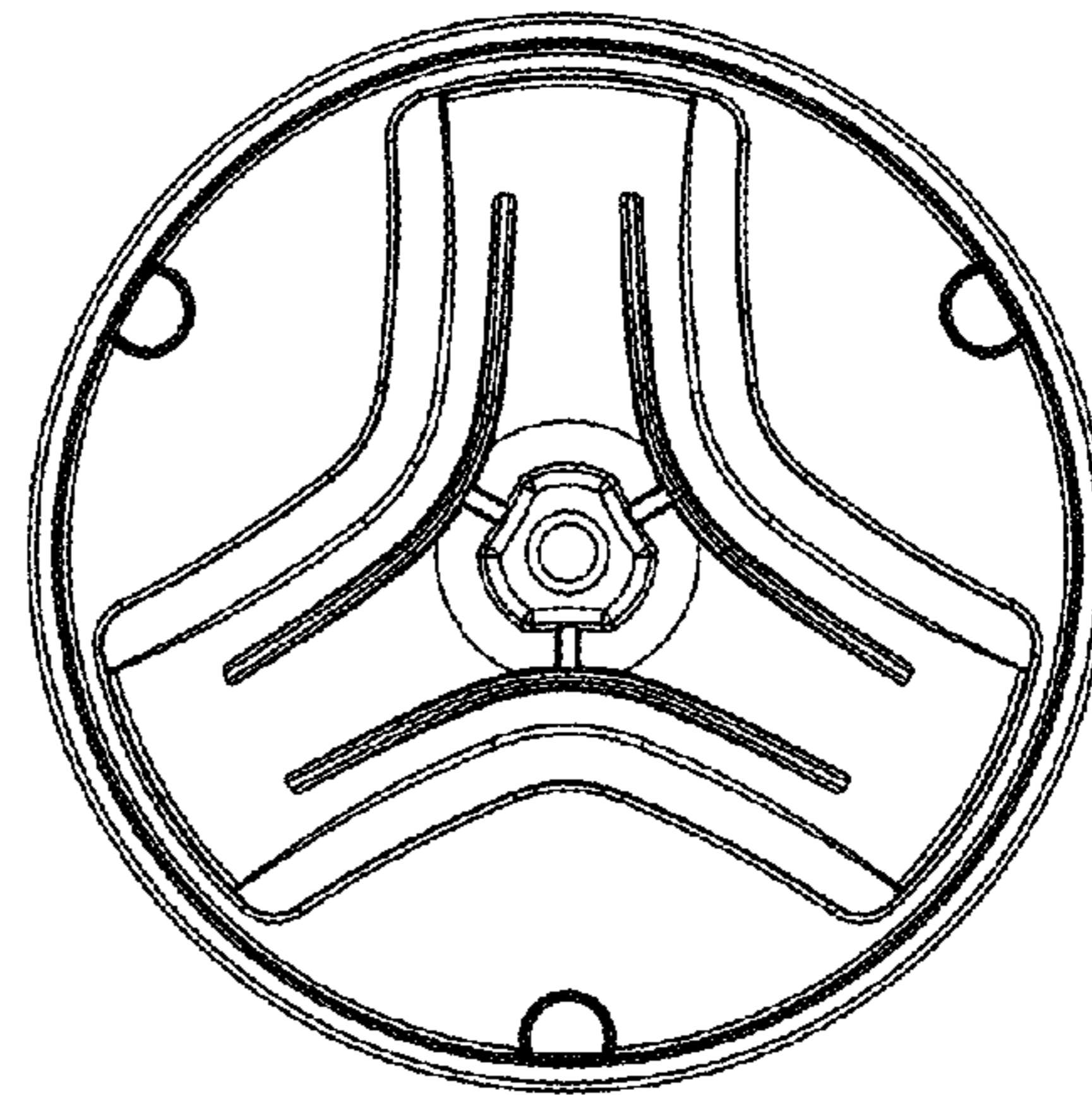

Fig. 7