



US00D734065S

(12) **United States Design Patent**
Prudenti

(10) **Patent No.:** **US D734,065 S**

(45) **Date of Patent:** **** Jul. 14, 2015**

(54) **HIGH CHAIR PROTECTIVE COVER**

(71) Applicant: **John Prudenti**, Napa, CA (US)

(72) Inventor: **John Prudenti**, Napa, CA (US)

(**) Term: **14 Years**

(21) Appl. No.: **29/496,104**

(22) Filed: **Jul. 9, 2014**

(51) **LOC (10) Cl.** **06-13**

(52) **U.S. Cl.**
USPC **D6/611**

(58) **Field of Classification Search**
USPC D6/611, 610, 596, 601, 602, 603, 615,
D6/617, 621; D7/332, 334-337;
D12/401-405; 135/87, 88.01, 95;
150/165-167, 158, 154; 280/770;
296/136.01, 136.1, 136.11
See application file for complete search history.

(56) **References Cited**

U.S. PATENT DOCUMENTS

D229,874 S *	1/1974	Scharf	D2/719
4,946,221 A *	8/1990	Livingston	297/184.13
D384,188 S *	9/1997	Imm	D2/719
D395,372 S *	6/1998	Simpson	D6/611
6,012,184 A *	1/2000	Childers	5/416

6,209,953 B1 *	4/2001	Mackay et al.	297/184.13
6,481,791 B1 *	11/2002	Facchini et al.	297/184.13
D546,108 S *	7/2007	Heiman-Philpott	D6/611
D562,612 S *	2/2008	Simpson et al.	D6/611
8,113,580 B1	2/2012	Pusateri		
2010/0065172 A1	3/2010	Dus		
2011/0012404 A1	1/2011	Cariera		

* cited by examiner

Primary Examiner — Katrina A Betton

(74) *Attorney, Agent, or Firm* — Crossley Patent Law

(57) **CLAIM**

The ornamental design for a high chair protective cover, as shown and described.

DESCRIPTION

FIG. 1 is a front elevation view of a high chair protective cover showing my new design;
FIG. 2 is a rear elevation view thereof;
FIG. 3 is a right side elevation view thereof, the opposite side being a mirror image of the shown;
FIG. 4 is a top plan view thereof;
FIG. 5 is a bottom plan view thereof; and,
FIG. 6 is an isometric view thereof.

The broken lines in FIG. 6 of the drawings depict a high chair as environmental subject matter only and form no part of the claimed design.

1 Claim, 6 Drawing Sheets

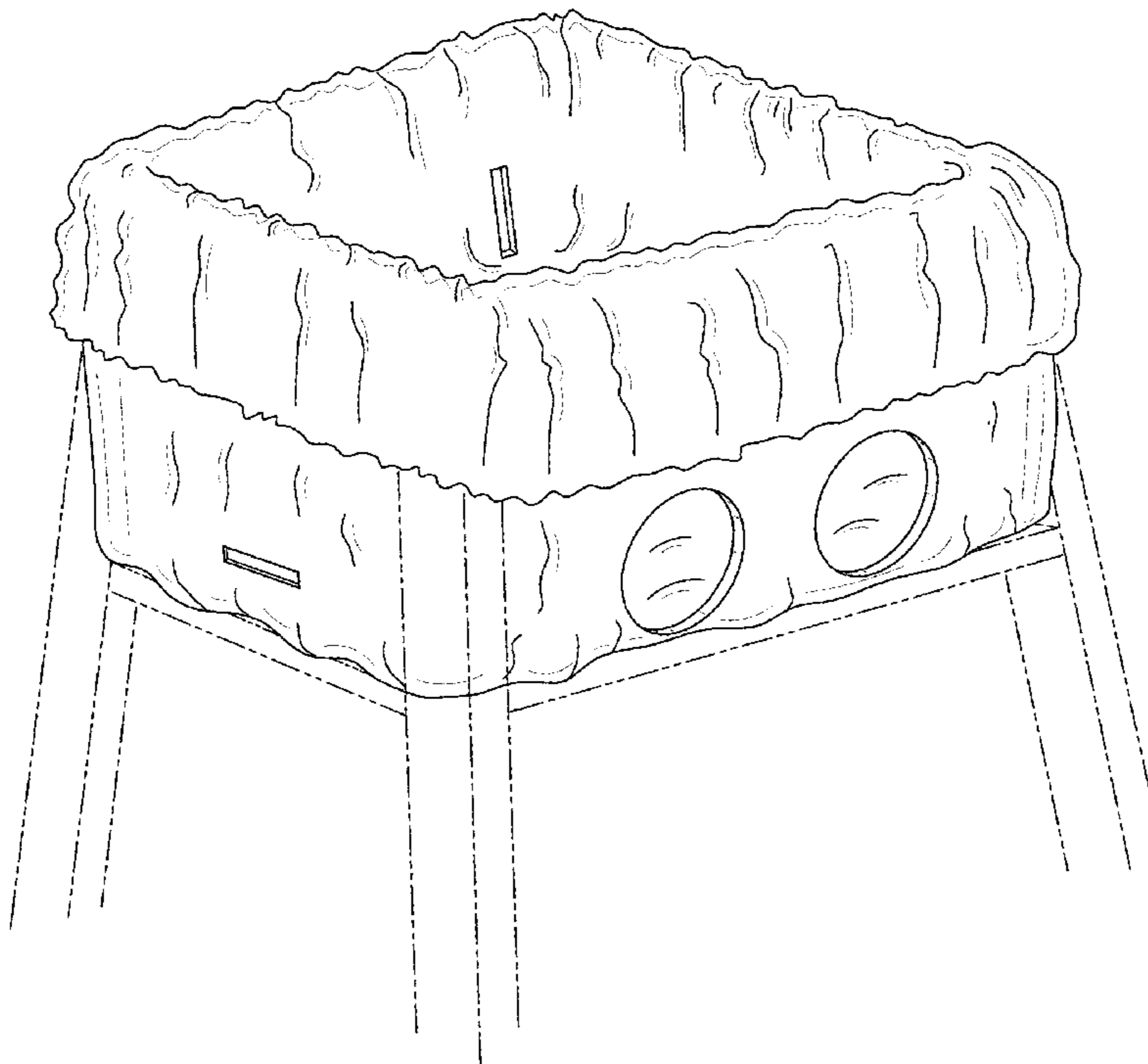

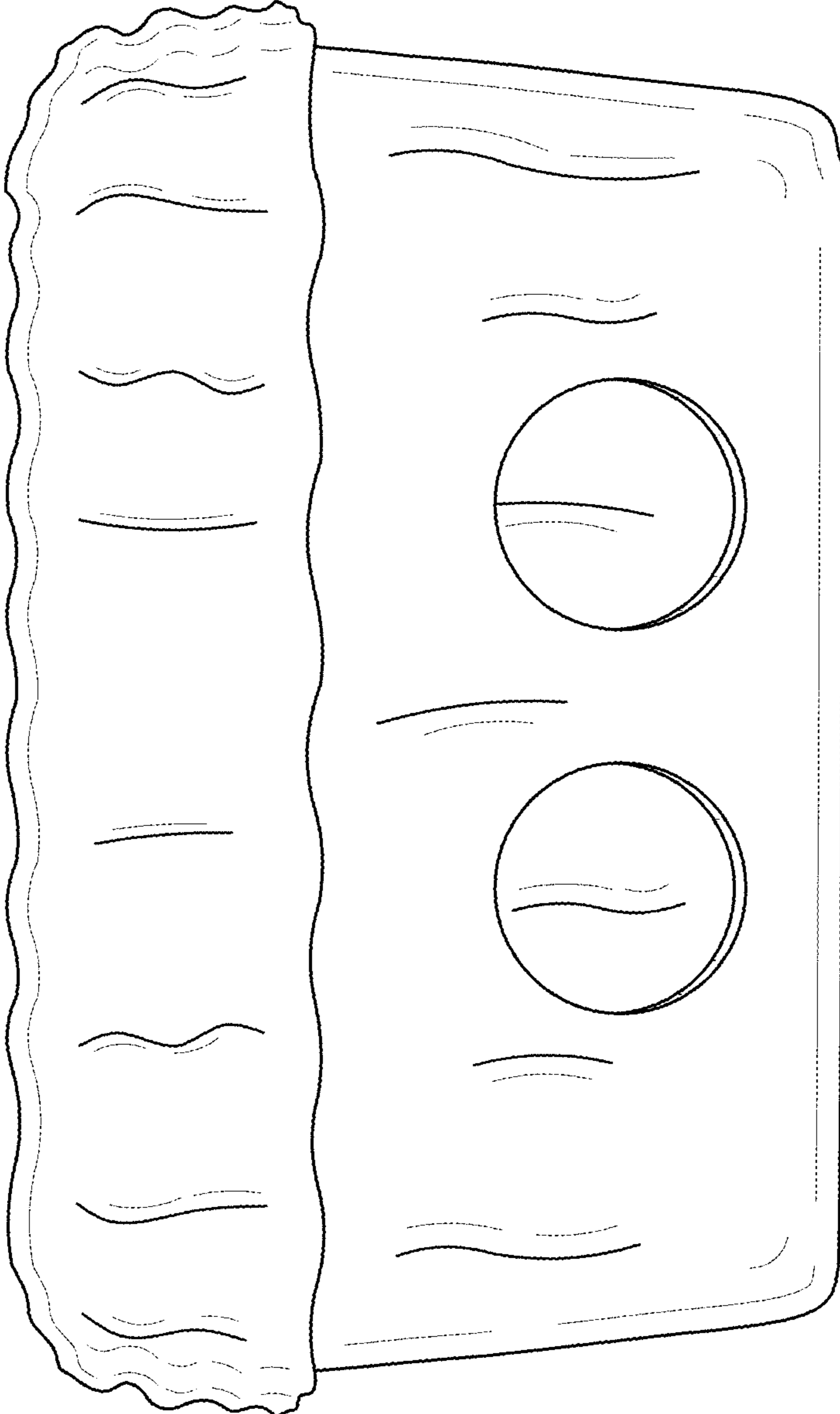

FIG. 1

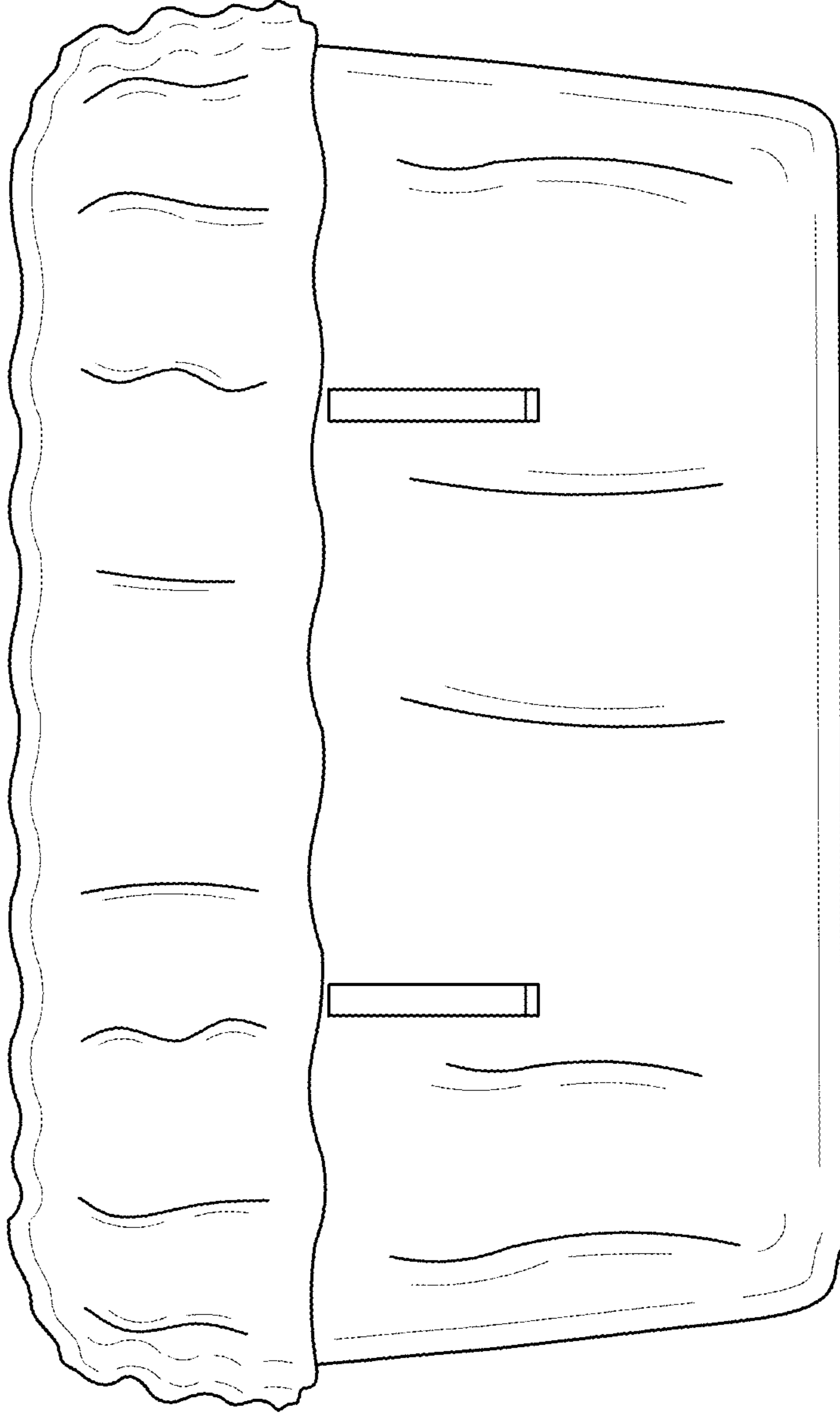

FIG. 2

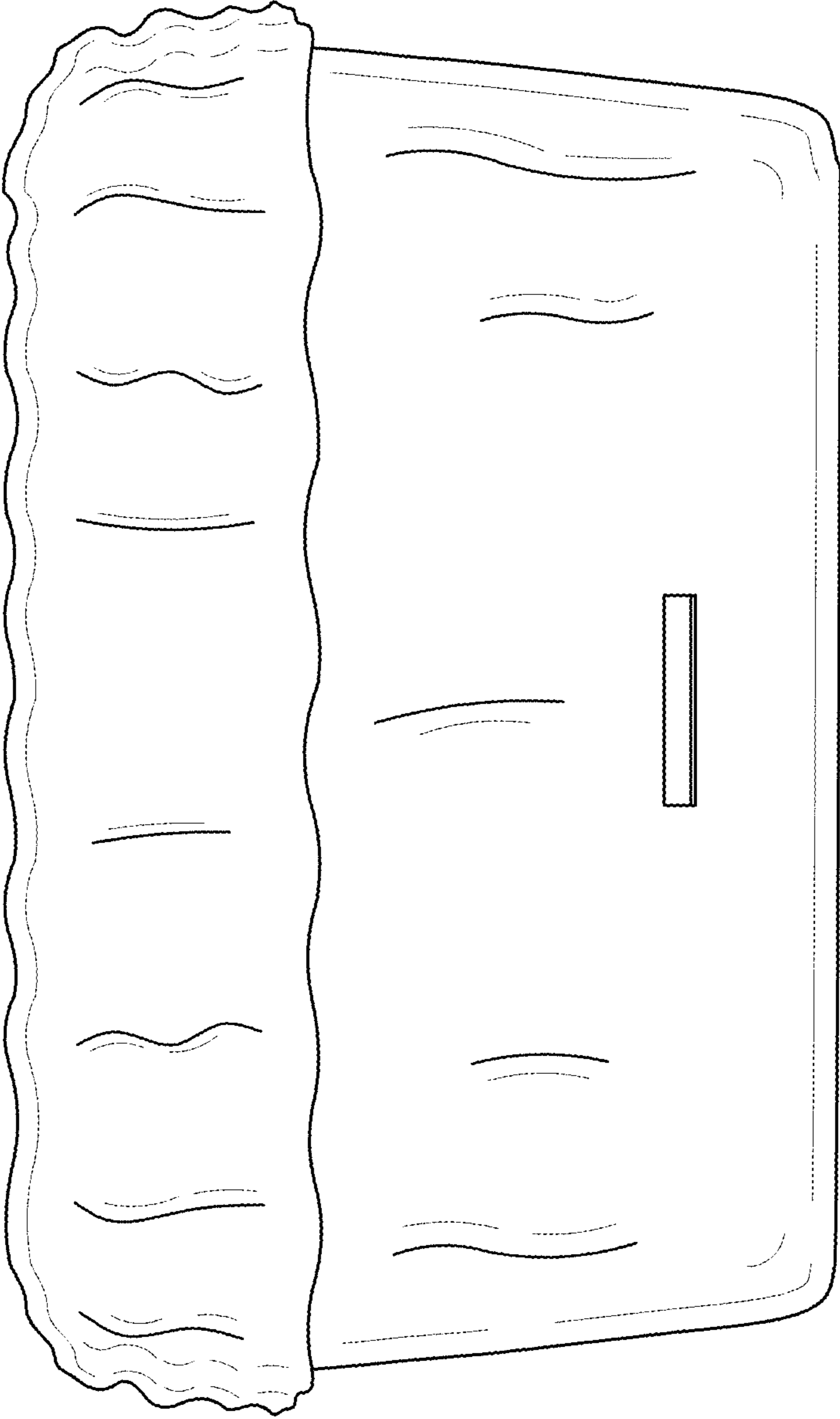

FIG. 3

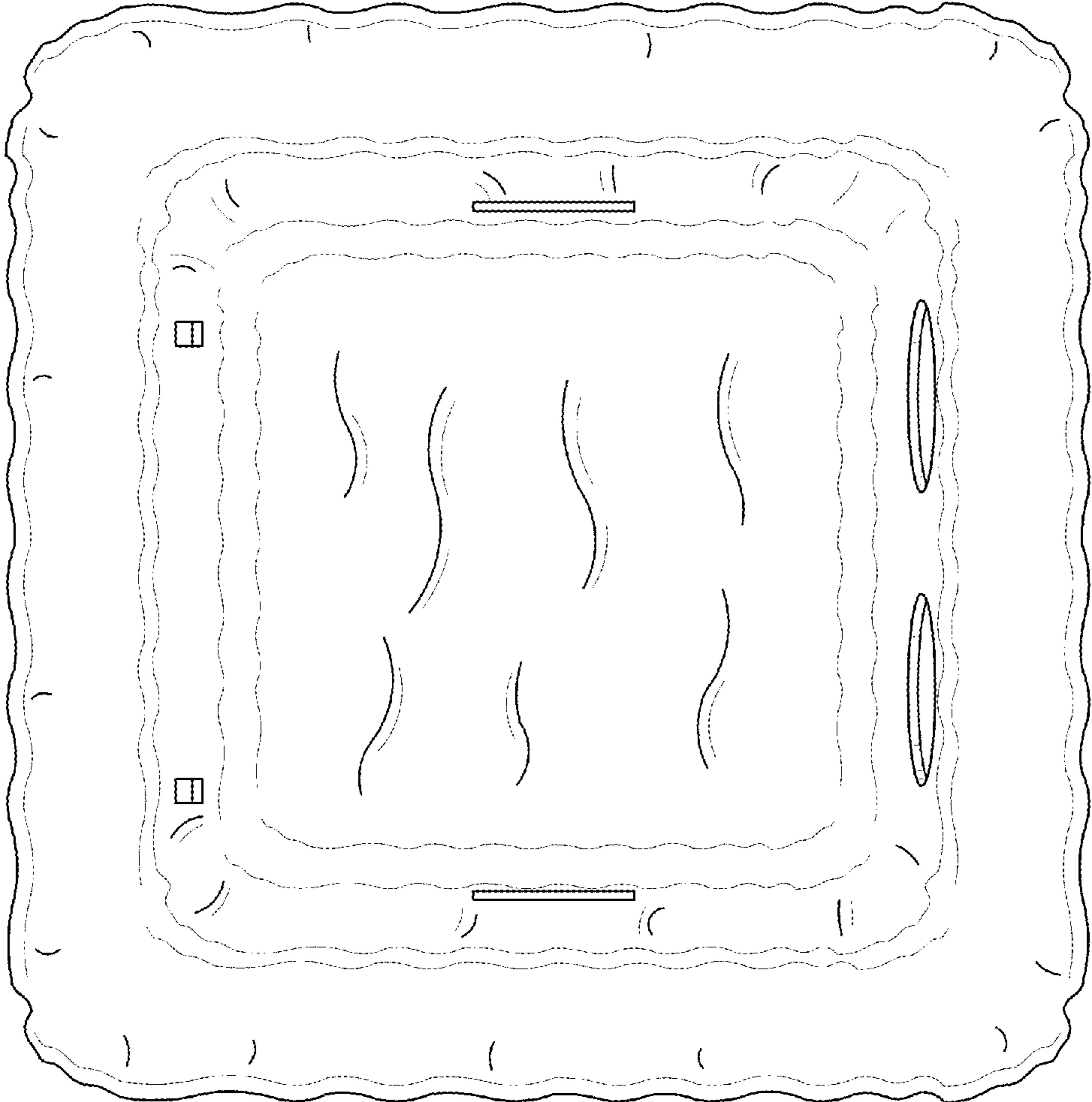

FIG. 4

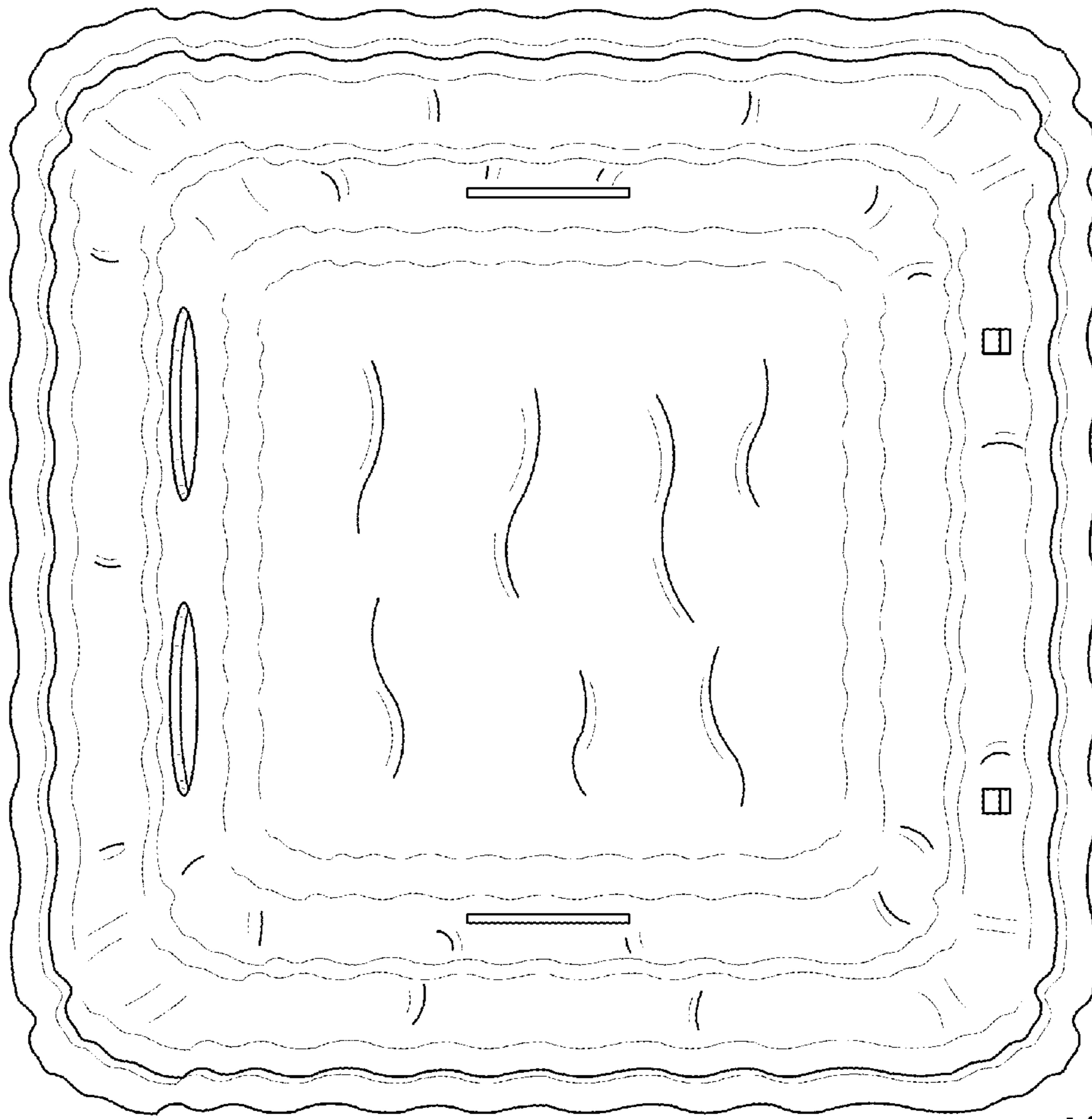

FIG. 5

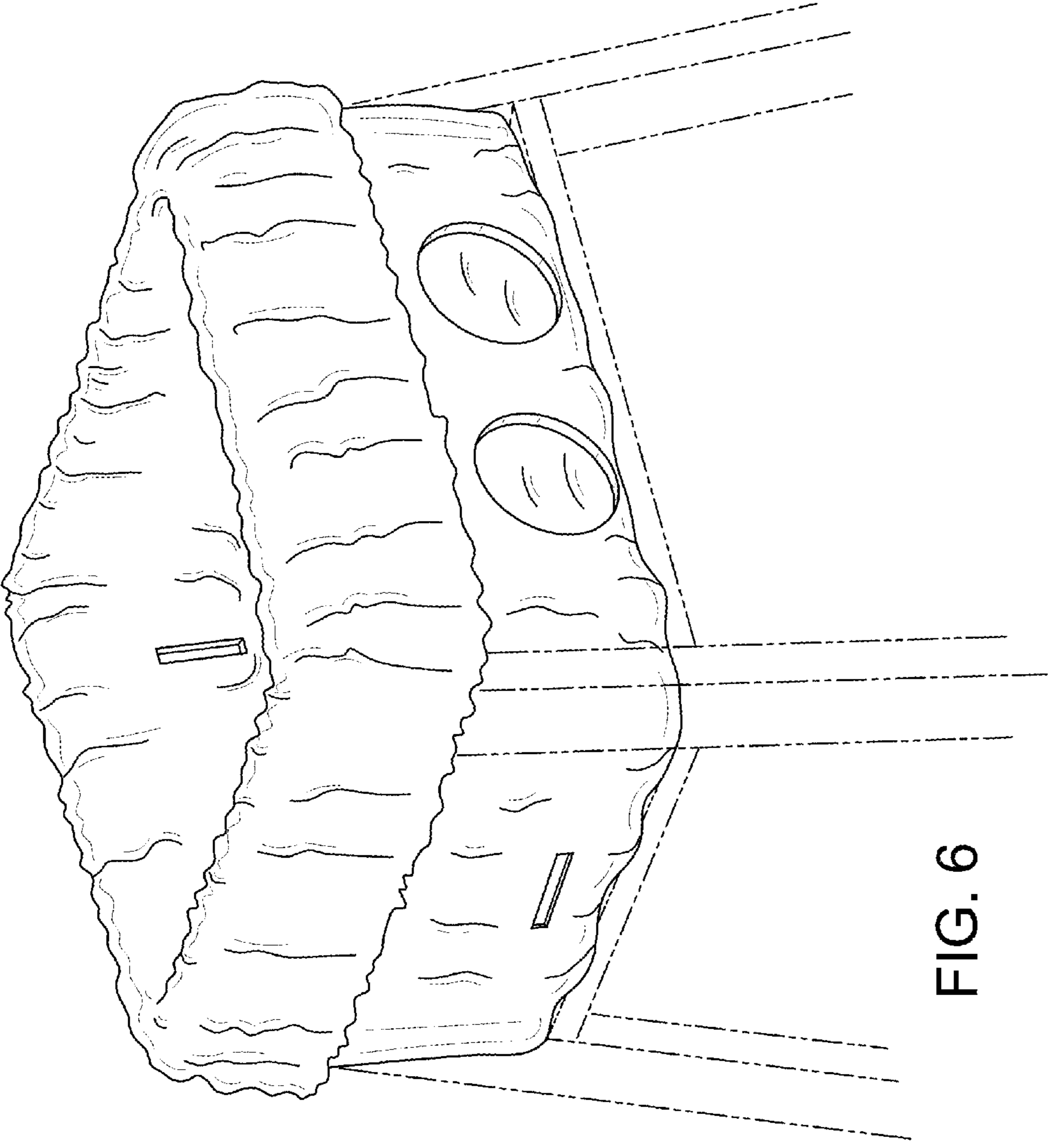

FIG. 6