



US00D733986S

(12) **United States Design Patent**
Edwards et al.

(10) **Patent No.:** **US D733,986 S**
(45) **Date of Patent:** **** Jul. 7, 2015**

(54) **BAG HOLDER**

(71) Applicant: **ESD Alliance Inc.**, Lethbridge, Alberta (CA)

(72) Inventors: **Jim Edwards**, Lethbridge (CA); **Chris Edwards**, Lethbridge (CA)

(73) Assignee: **EDS Alliance, Inc.**, Lethbridge, Alberta (CA)

(**) Term: **14 Years**

(21) Appl. No.: **29/461,613**

(22) Filed: **Jul. 25, 2013**

(30) **Foreign Application Priority Data**

Jan. 25, 2013 (CA) 149494

(51) **LOC (10) Cl.** **09-09**

(52) **U.S. Cl.**
USPC **D34/6**

(58) **Field of Classification Search**
USPC D34/1, 4-27; 248/99, 95, 97, 439, 128, 248/132, 136, 146, 147, 98, 164, 100, 131, 248/544, 558, 210, 175; 141/391, 315, 316, 141/390; 15/257.3, 257.1, 257.4, 257.6; 220/495.08, 495.09, 486; 297/184.15; 211/50, 119, 195; 100/34; 53/390; D6/566, 678.4; 108/11, 133
CPC B65F 1/1415; B65F 2240/138; B65F 2001/061; B65F 1/062; B65F 1/141; B65F 2220/106
See application file for complete search history.

(56) **References Cited**

U.S. PATENT DOCUMENTS

447,686 A * 3/1891 Holladay 248/97
1,006,328 A * 10/1911 Widenhofer 211/195

2,470,977 A * 5/1949 Chidsey, Jr. 248/97
D171,557 S * 2/1954 Remstein D6/462
D212,291 S * 9/1968 Hamilton et al. D6/462
D216,437 S * 1/1970 Vosbiklam D34/6
D216,438 S * 1/1970 Bexley et al. D34/6
D223,616 S * 5/1972 Woods D6/462
3,659,816 A * 5/1972 Wilson 248/97
D227,324 S * 6/1973 Rauch D6/462
D246,565 S * 12/1977 Roark D34/6
4,174,085 A * 11/1979 Ferreira et al. 248/97

(Continued)

Primary Examiner — Cynthia Ramirez

Assistant Examiner — Gino Colan

(74) *Attorney, Agent, or Firm* — Ohlandt, Greeley, Ruggiero & Perle, L.L.P.

(57) **CLAIM**

The ornamental design for a bag holder, as shown and described.

DESCRIPTION

FIG. 1 is a perspective view of a bag holder according to the present invention in an extended configuration; FIG. 2 is a front elevation corresponding to FIG. 1; FIG. 3 is an end elevation corresponding to FIG. 1. The opposite end elevation would be a mirror image of FIG. 3; FIG. 4 is a rear elevation corresponding to FIG. 1; FIG. 5 is a top plan view corresponding to FIG. 1; FIG. 6 is a bottom plan view corresponding to FIG. 1; FIG. 7 is a perspective view from above of the bag holder in a retracted configuration; FIG. 8 is a front elevation corresponding to FIG. 7; FIG. 9 is an end elevation corresponding to FIG. 7; FIG. 10 is a rear elevation corresponding to FIG. 7; FIG. 11 is a top plan view corresponding to FIG. 7; FIG. 12 is a bottom plan view corresponding to FIG. 7; and, FIG. 13 is a perspective view from above of the bag holder in FIG. 7. In a disassembled configuration.

1 Claim, 10 Drawing Sheets

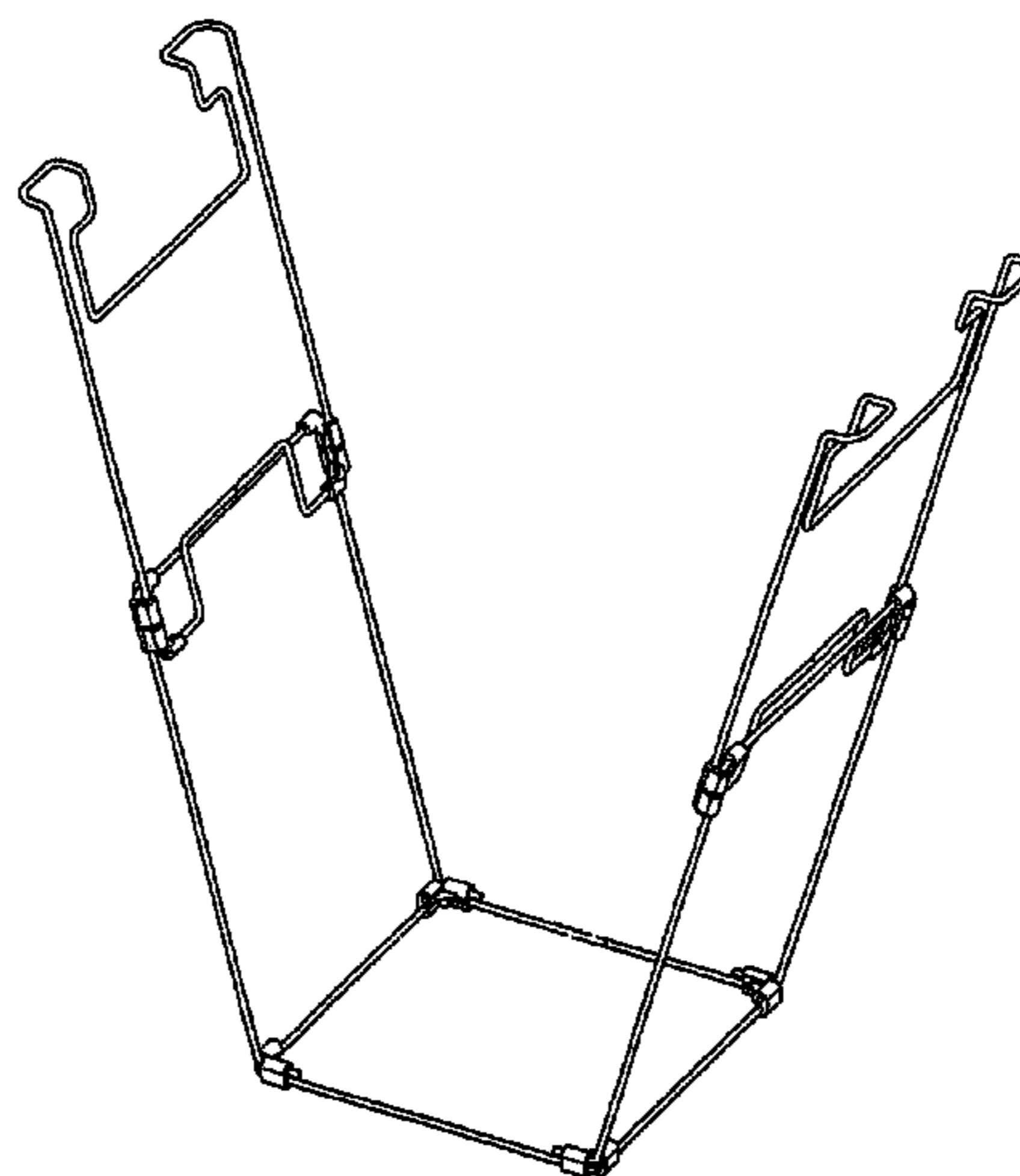

(56)

References Cited

U.S. PATENT DOCUMENTS

4,467,989 A *	8/1984	Stroh	248/97	5,427,340 A *	6/1995	Stromsmoe et al.	248/97
4,479,344 A *	10/1984	Edwards	53/390	D371,661 S *	7/1996	Linder	D34/21
4,613,104 A *	9/1986	Garrott	248/97	5,775,649 A *	7/1998	O'Leary	248/97
4,687,249 A *	8/1987	Mills	297/184.15	D398,121 S *	9/1998	Siu	D34/6
4,723,743 A *	2/1988	Jenkins	248/97	D418,653 S *	1/2000	Kent, Jr.	D34/6
4,783,031 A *	11/1988	Ebentheuer	248/97	D421,170 S *	2/2000	Siu	D34/6
D308,271 S *	5/1990	Vreeken	D34/6	6,267,334 B1 *	7/2001	Siu	248/97
4,921,193 A *	5/1990	Benesch	248/97	6,325,341 B1 *	12/2001	Brown	248/99
D318,352 S *	7/1991	Allen	D34/5	6,402,098 B2 *	6/2002	Rosky	248/99
D319,124 S *	8/1991	Harjung	D34/5	6,454,223 B1 *	9/2002	Rosky	248/100
5,169,101 A *	12/1992	Wenzel et al.	248/97	7,032,868 B2 *	4/2006	Mutert	248/99
				D546,522 S *	7/2007	Naujoks	D34/6
				2010/0310197 A1 *	12/2010	Naujoks	383/104
				2011/0042381 A1 *	2/2011	Heller et al.	220/495.11

* cited by examiner

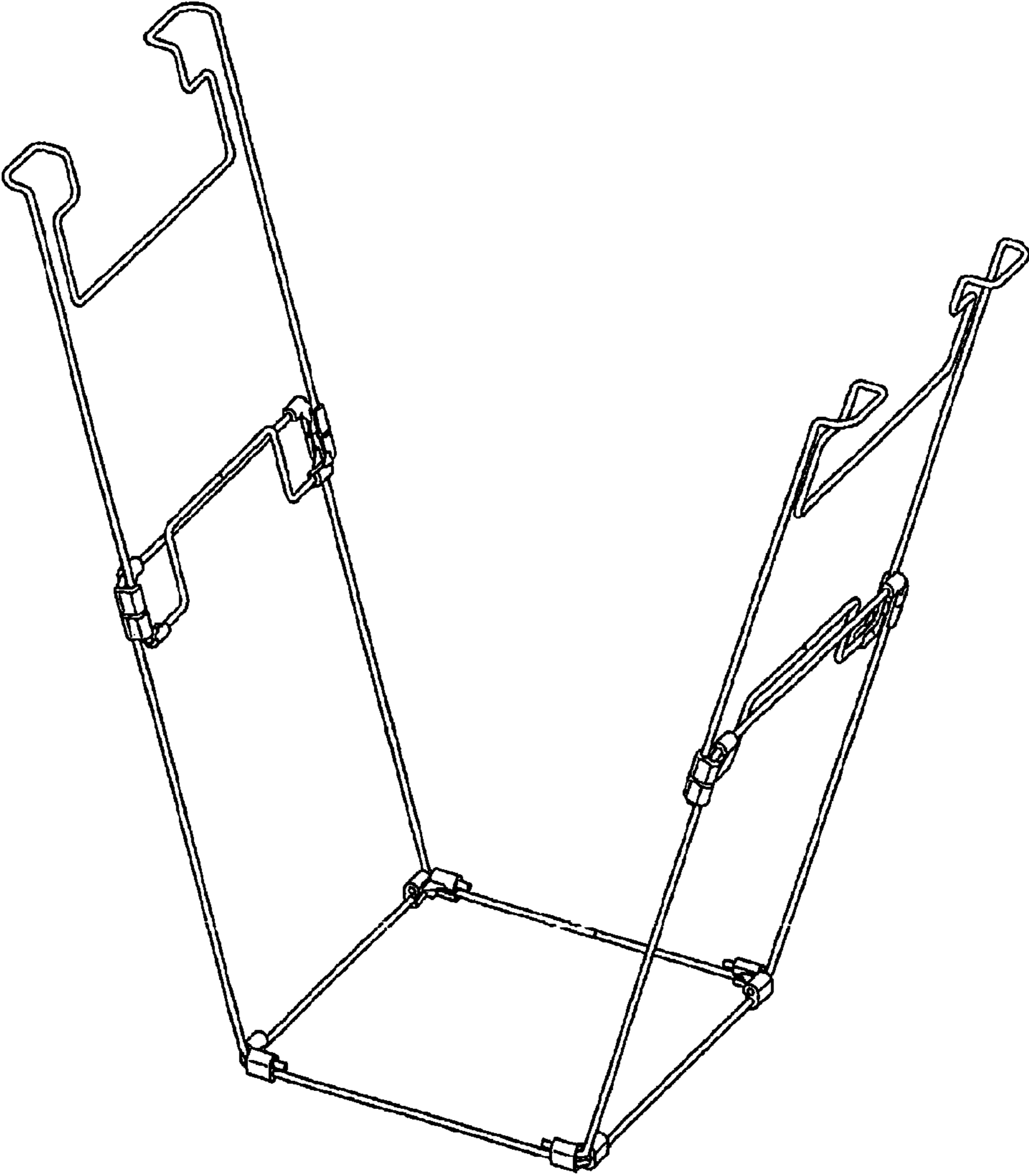

FIG. 1

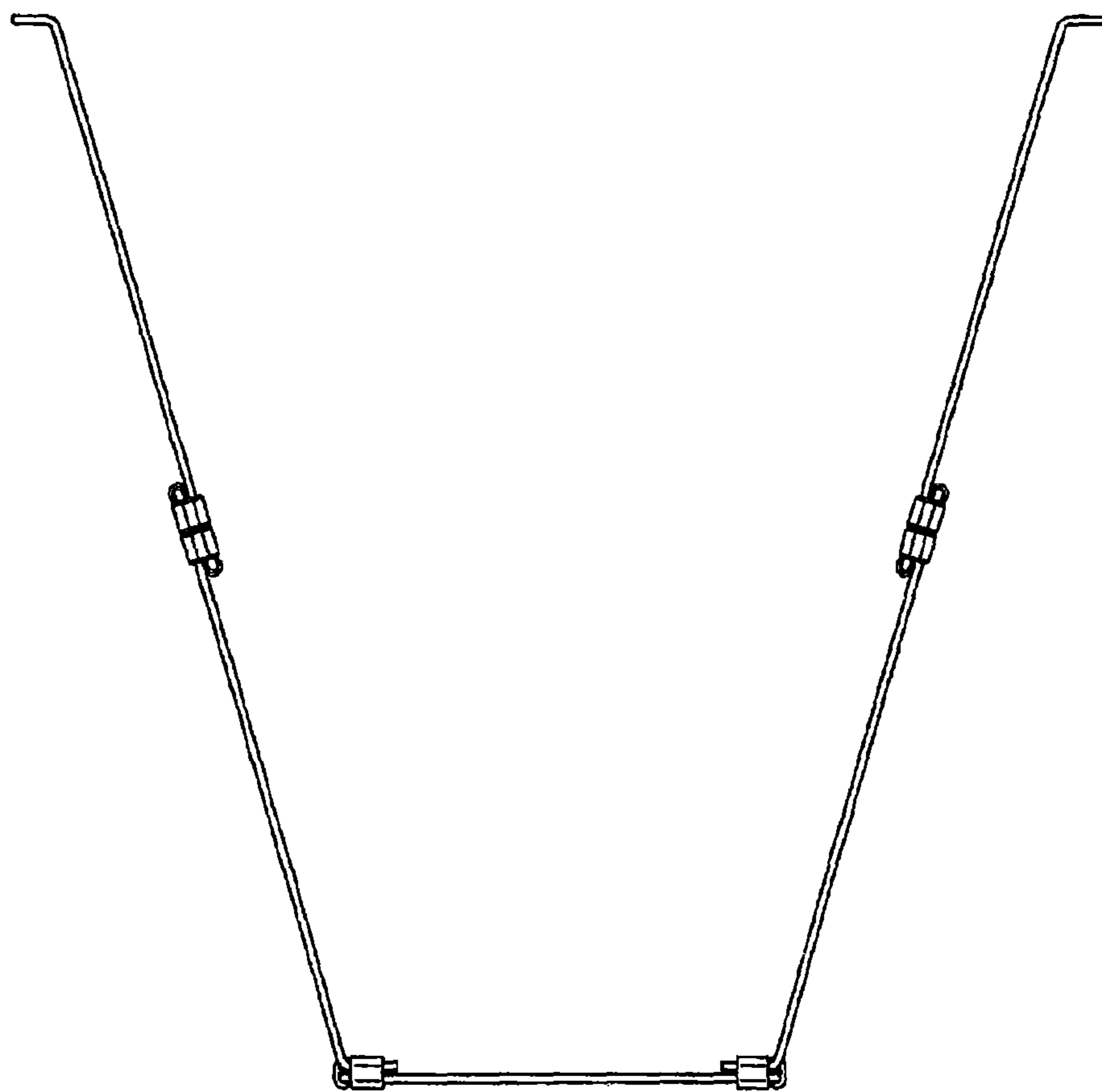

FIG. 2

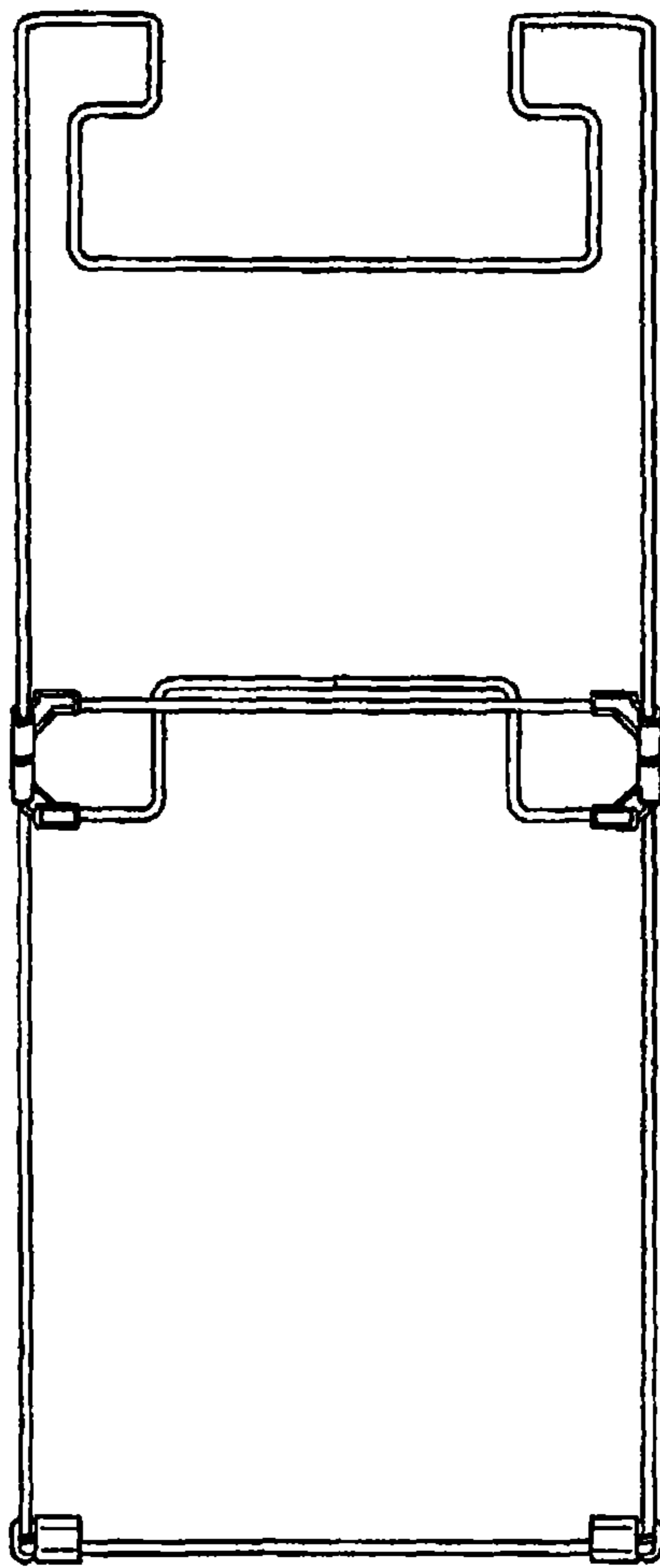

FIG. 3



FIG. 4

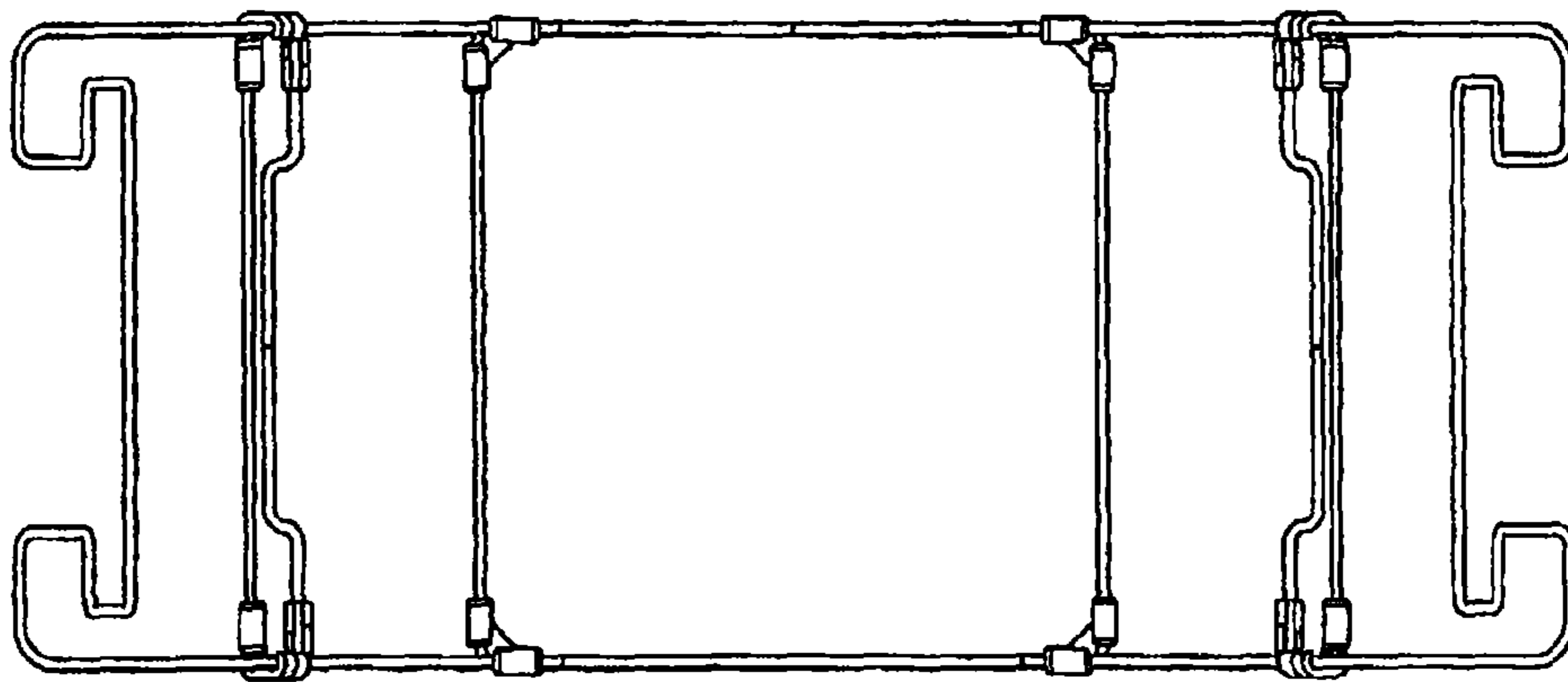

FIG. 5

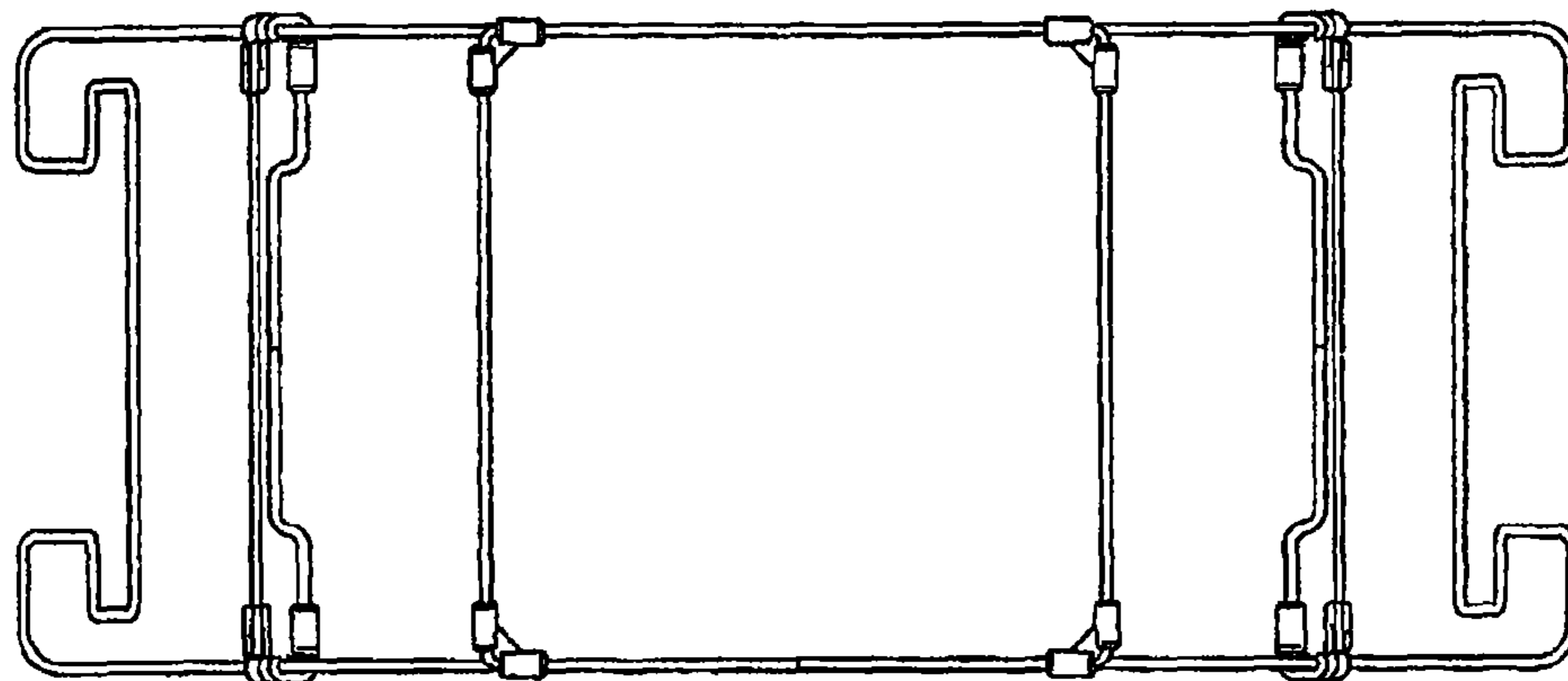

FIG. 6

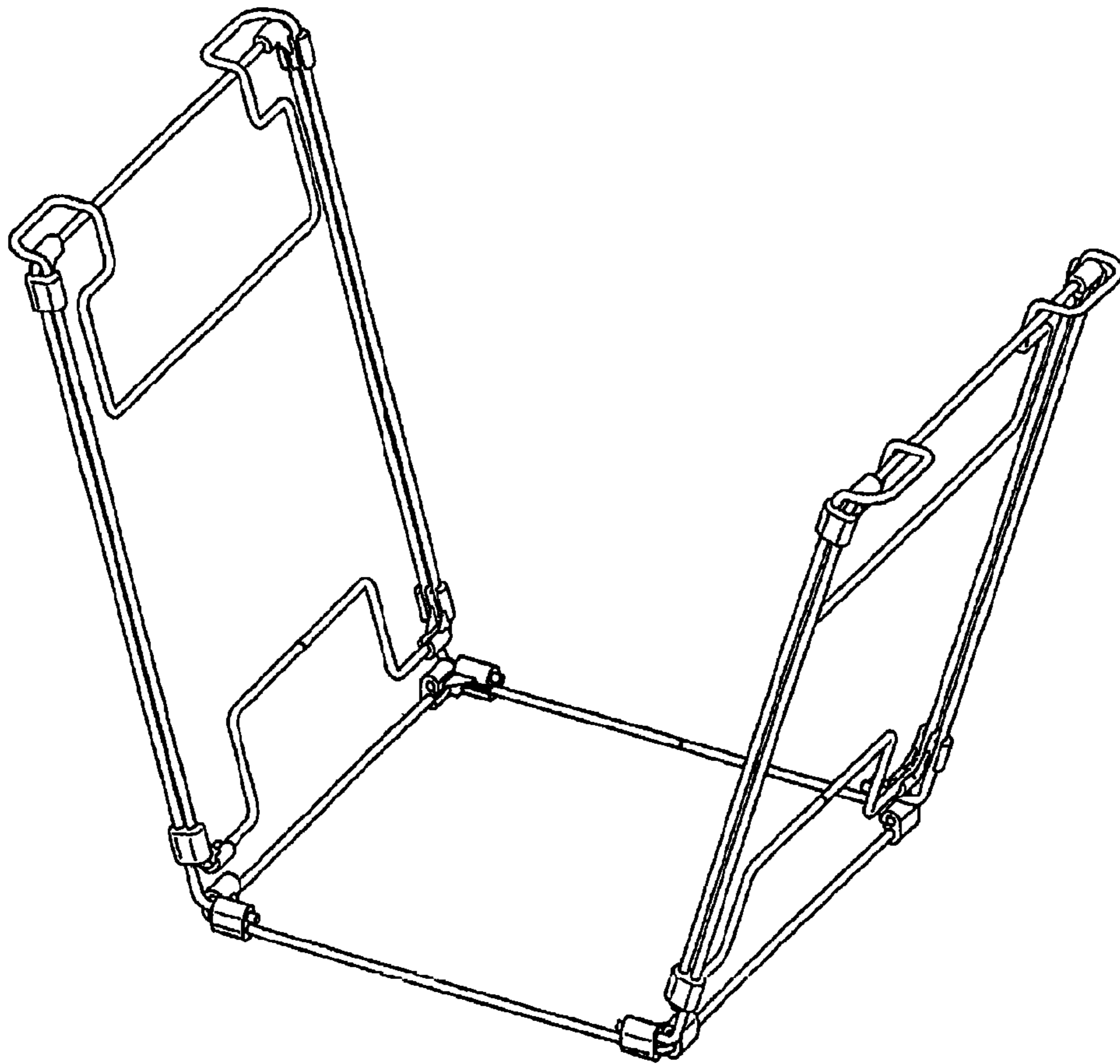

FIG. 7

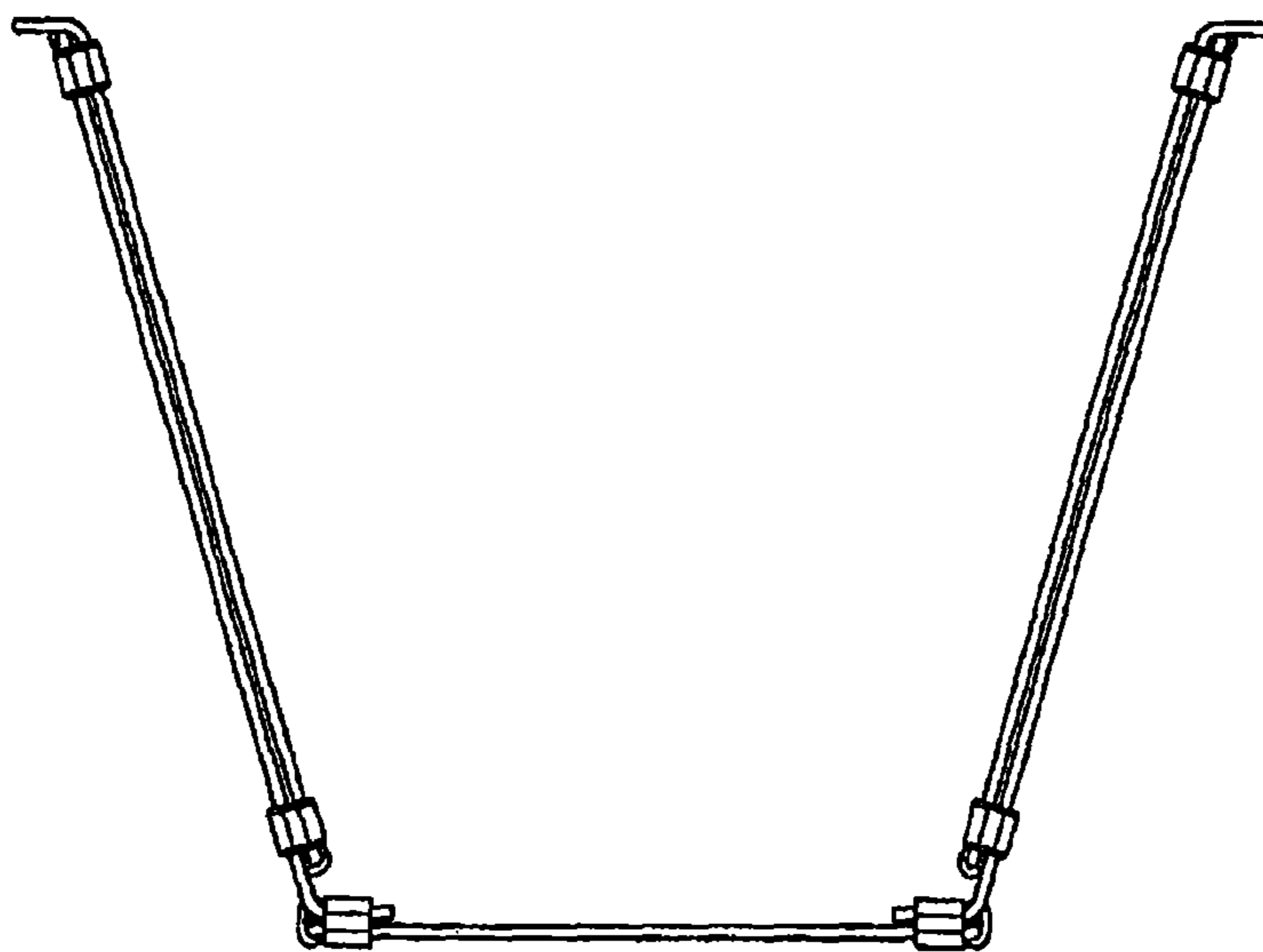

FIG. 8

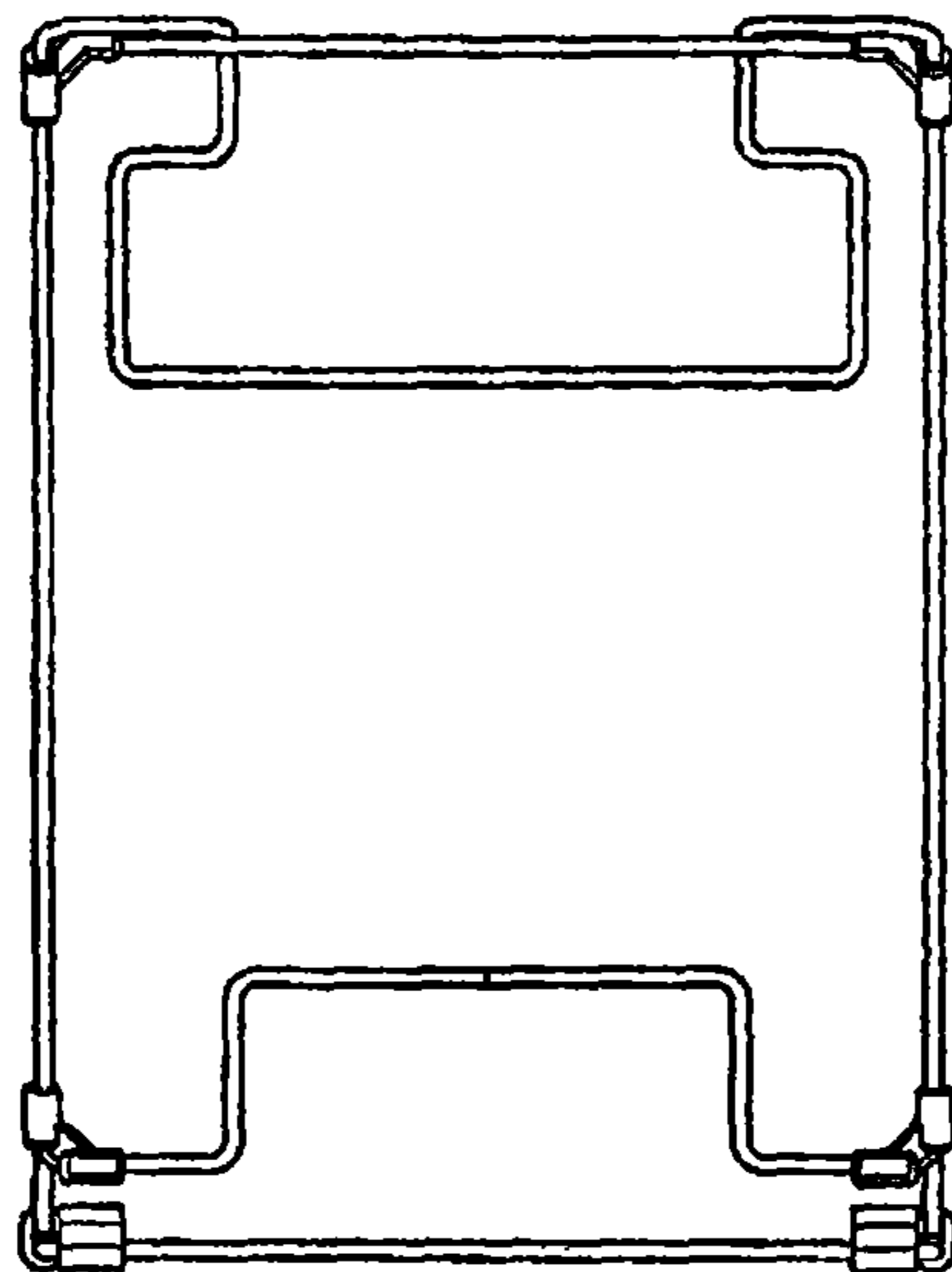

FIG. 9

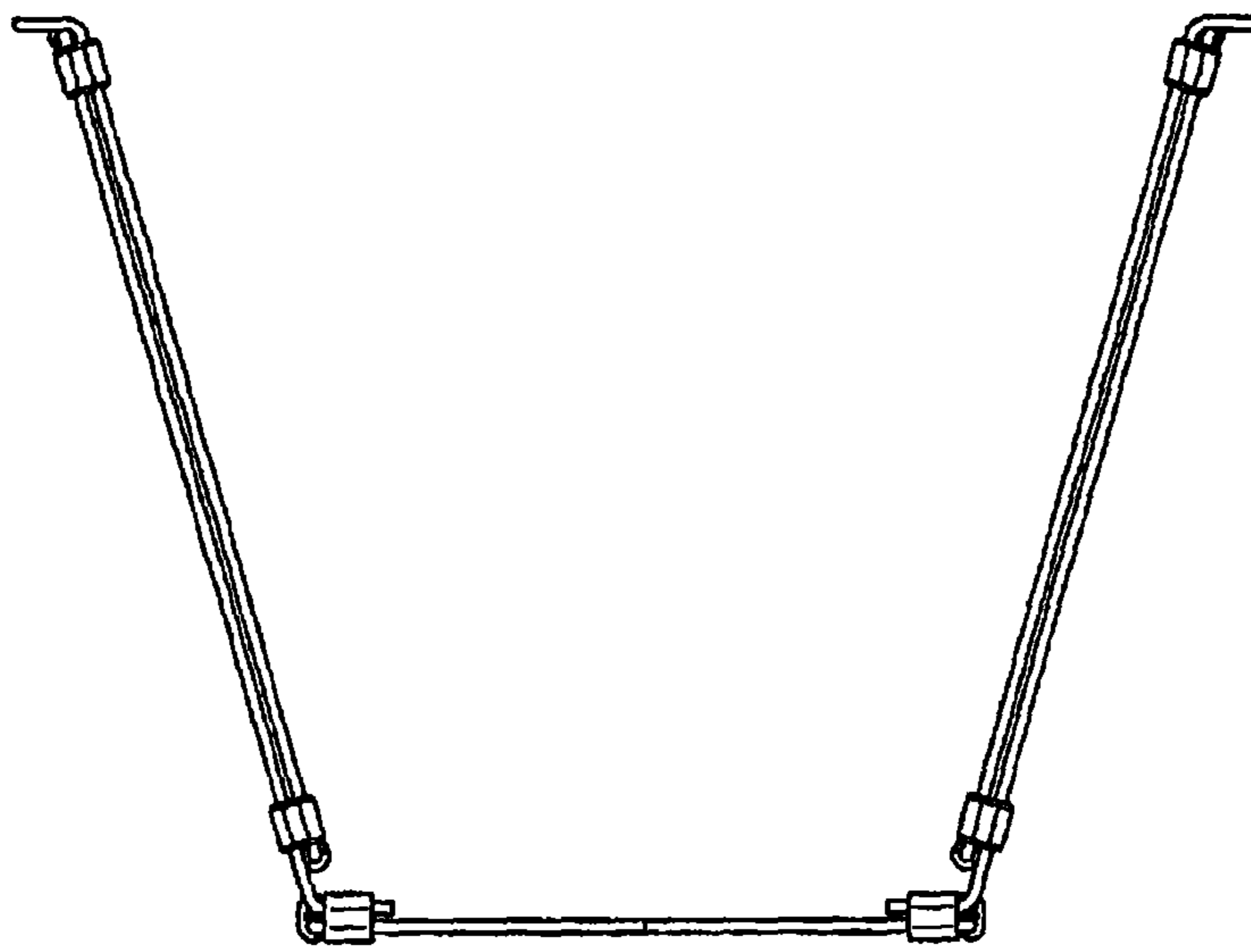

FIG. 10

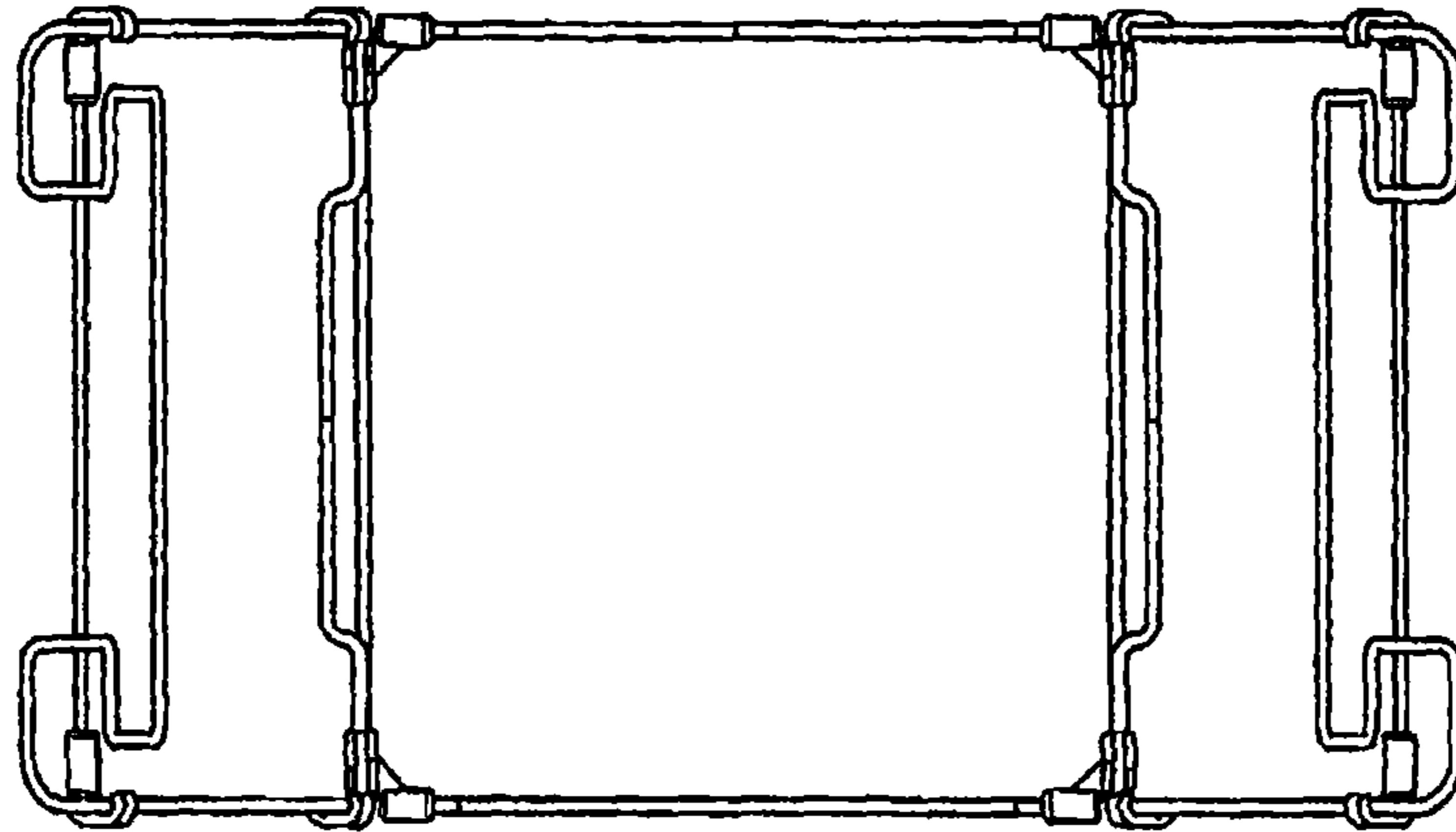

FIG. 11

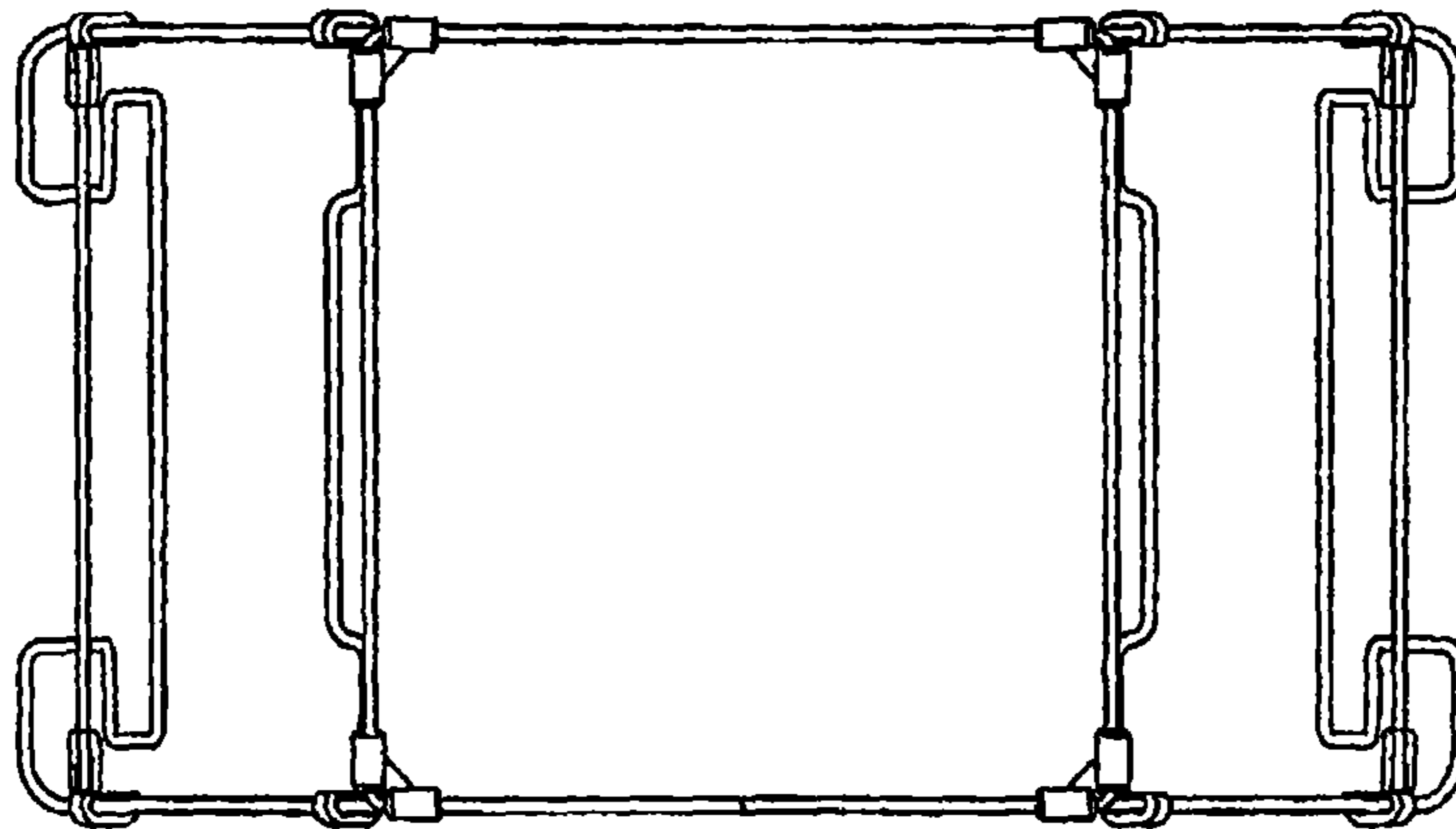

FIG. 12

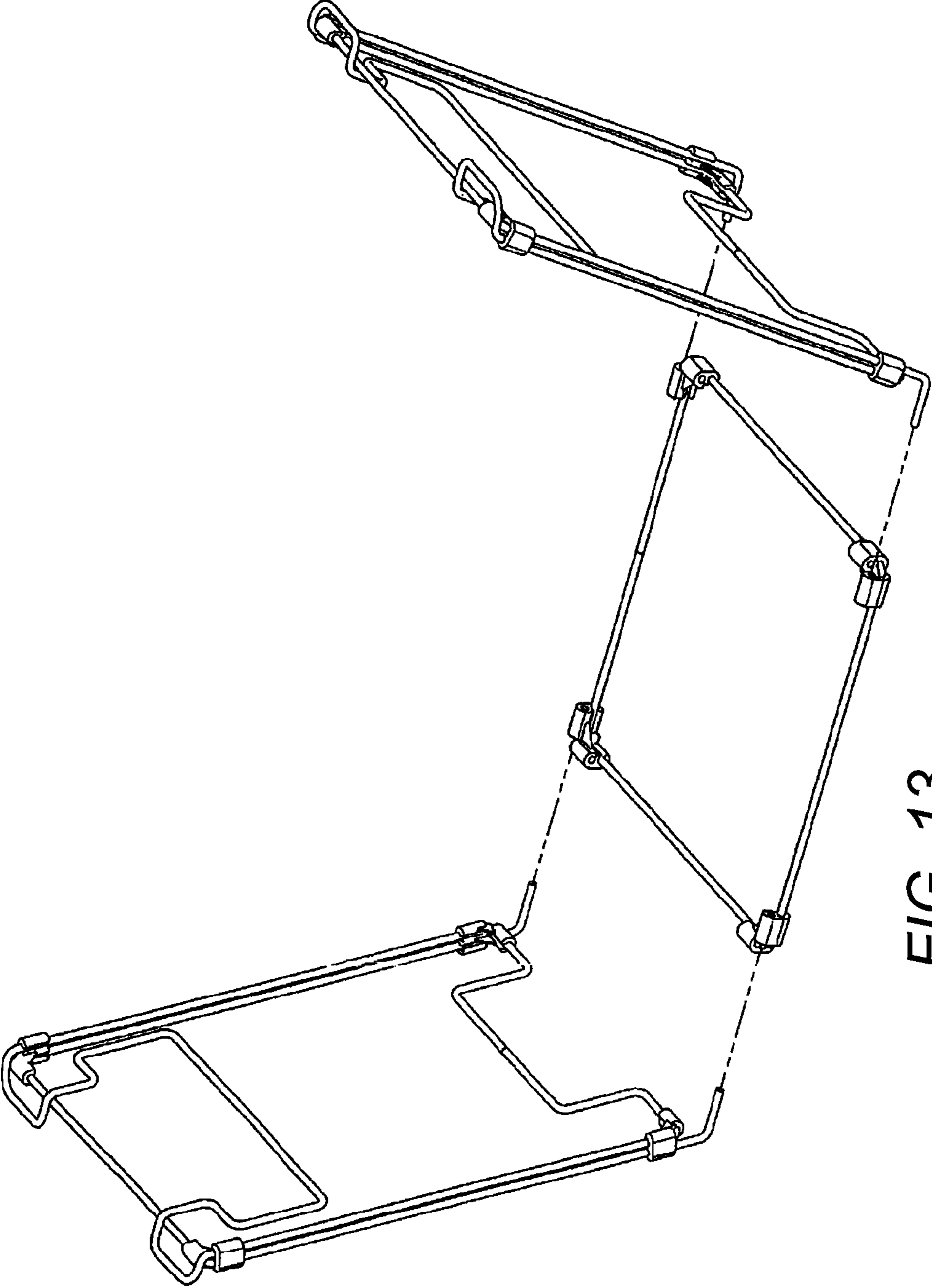

FIG. 13