



US00D733957S

(12) **United States Design Patent**
Tragatschnig

(10) **Patent No.:** **US D733,957 S**
(45) **Date of Patent:** **** Jul. 7, 2015**

(54) **LIGHT FIXTURE**

(71) Applicant: **Jörg Tragatschnig**, Zell am See (AT)

(72) Inventor: **Jörg Tragatschnig**, Zell am See (AT)

(73) Assignee: **Jörg Tragatschnig**, Zell am See (AT)

(**) Term: **14 Years**

(21) Appl. No.: **29/494,001**

(22) Filed: **Jun. 16, 2014**

(51) **LOC (10) Cl.** **26-99**

(52) **U.S. Cl.**
USPC **D26/118**

(58) **Field of Classification Search**
USPC D26/1-4, 24-26, 28, 34, 37-39, 43-45,
D26/50, 60, 61, 66-74, 85, 88, 89, 93, 94,
D26/104, 105, 108, 109, 113, 118-125, 138,
D26/142; 362/3, 4, 8, 145, 147, 150,
362/249.01-249.05, 296.01, 296.05, 317,
362/326, 327, 330, 331, 334, 335, 341, 347,
362/362, 364-366, 368, 370-373,
362/640-644; D10/106.2, 111, 113.1,
D10/113.2, 114.1; D11/131, 133, 142-145,
D11/149, 152-155, 200, 215; D14/204,
D14/207, 213-216, 250-253, 255, 348;
D25/42, 126

See application file for complete search history.

(56) **References Cited**

U.S. PATENT DOCUMENTS

D267,514 S *	1/1983	Leung	D26/37
D349,432 S *	8/1994	Kibbe	D26/38
D373,211 S *	8/1996	Heun	D26/44
D390,986 S *	2/1998	Yuen	D26/44
D414,713 S *	10/1999	Renk	D10/114.1
D484,252 S *	12/2003	Hughes et al.	D25/126
D491,061 S *	6/2004	Bouroullec et al.	D11/155
D507,259 S *	7/2005	Taylor	D14/215

D508,042 S *	8/2005	Oikawa	D14/214
D557,256 S *	12/2007	Joseph	D14/214
D627,503 S *	11/2010	Postelmans	D26/93
D633,083 S *	2/2011	Tellier	D14/215
D638,821 S *	5/2011	Hoehn et al.	D14/214
D641,338 S *	7/2011	Chen	D14/214
D643,964 S *	8/2011	Heyrman	D26/85
D643,965 S *	8/2011	Sprengers	D26/85
D671,659 S *	11/2012	Clayton	D25/126
D707,202 S *	6/2014	McManigal	D14/214
D716,765 S *	11/2014	Kim et al.	D14/215

* cited by examiner

Primary Examiner — Cynthia Ramirez

Assistant Examiner — Llorellys Martinez-Rivera

(74) *Attorney, Agent, or Firm* — Michael G. Kelber; Neal, Gerber & Eisenberg

(57) **CLAIM**

The ornamental design for a light fixture, as shown and described.

DESCRIPTION

FIG. 1 is a bottom perspective view of a light fixture in accordance with the present invention; FIG. 2 is a front view of the light fixture depicted in FIG. 1; FIG. 3 is a rear side view of the light fixture depicted in FIG. 1; FIG. 4 is a left side view of the light fixture depicted in FIG. 1; FIG. 5 is a right side view of the light fixture depicted in FIG. 1; FIG. 6 is a bottom view of the light fixture depicted in FIG. 1; FIG. 7 is a top view of the light fixture depicted in FIG. 1; and, FIG. 8 is a rear perspective view of the light fixture depicted in FIG. 1.

The broken lines shown in FIGS. 1 through 8 illustrate portions of the light fixture which form no part of the claimed design.

1 Claim, 6 Drawing Sheets

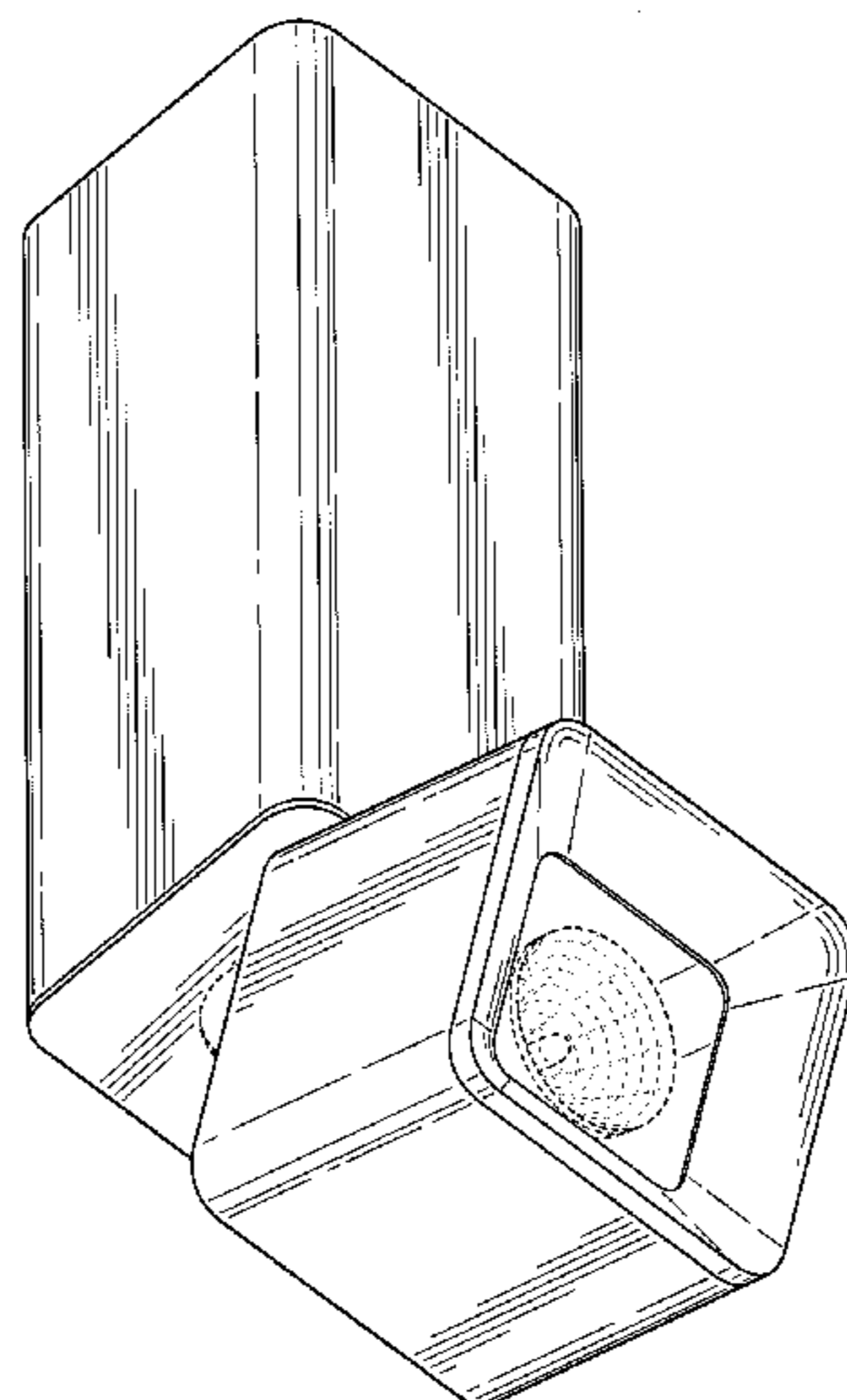

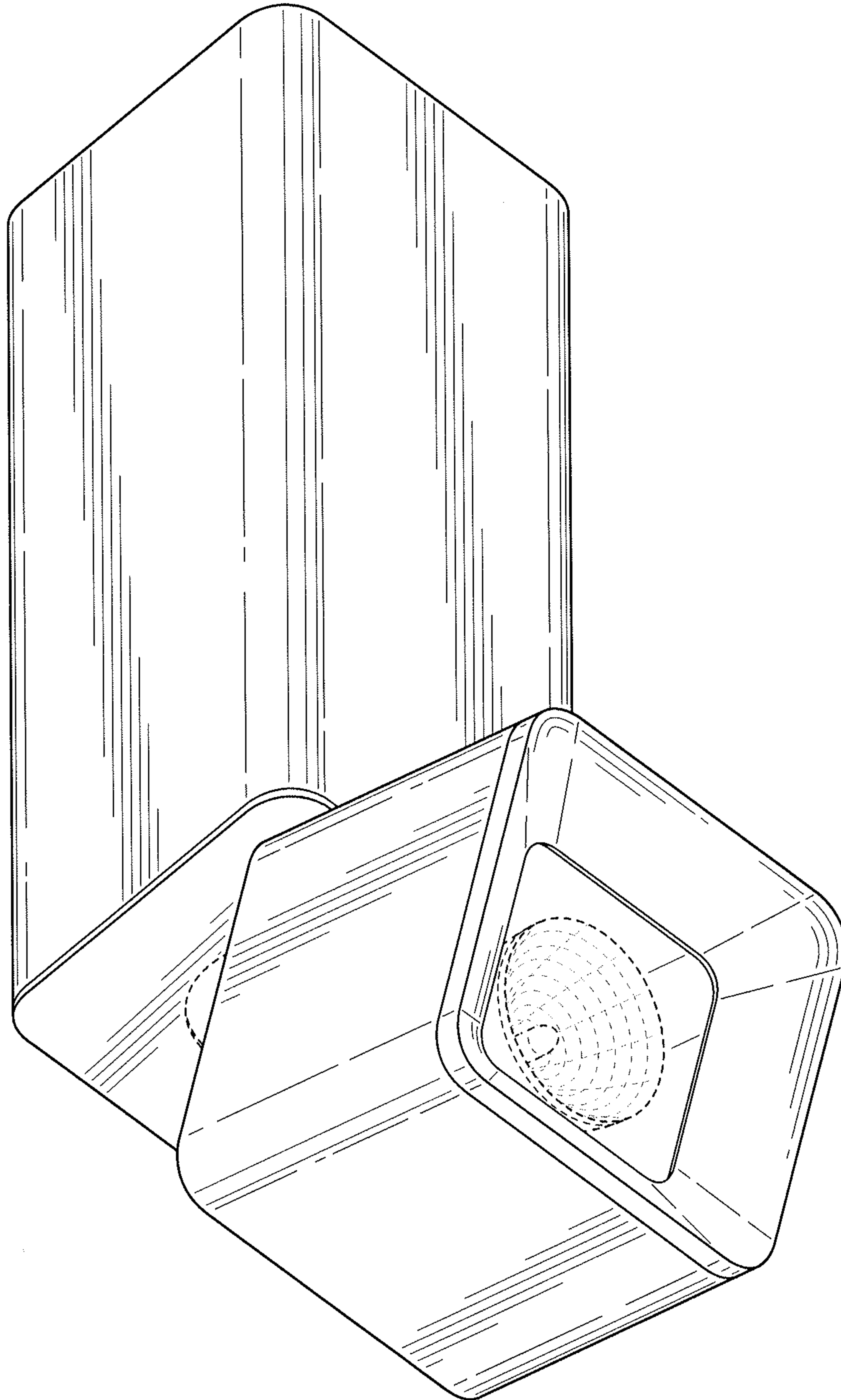

FIG. 1

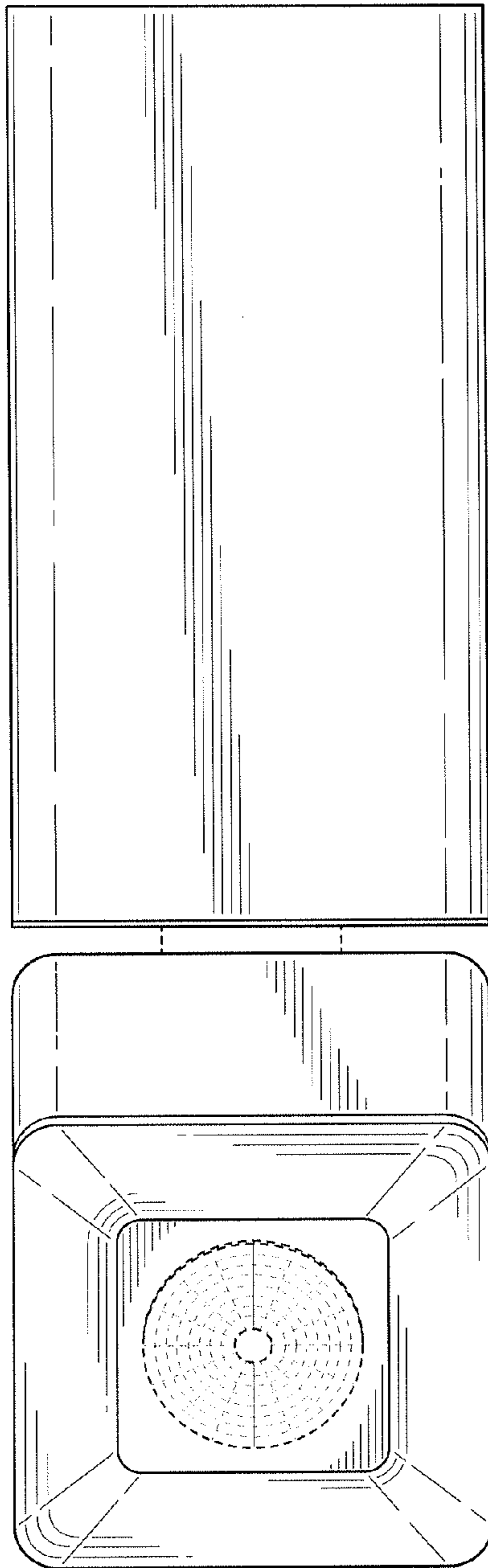

FIG. 2

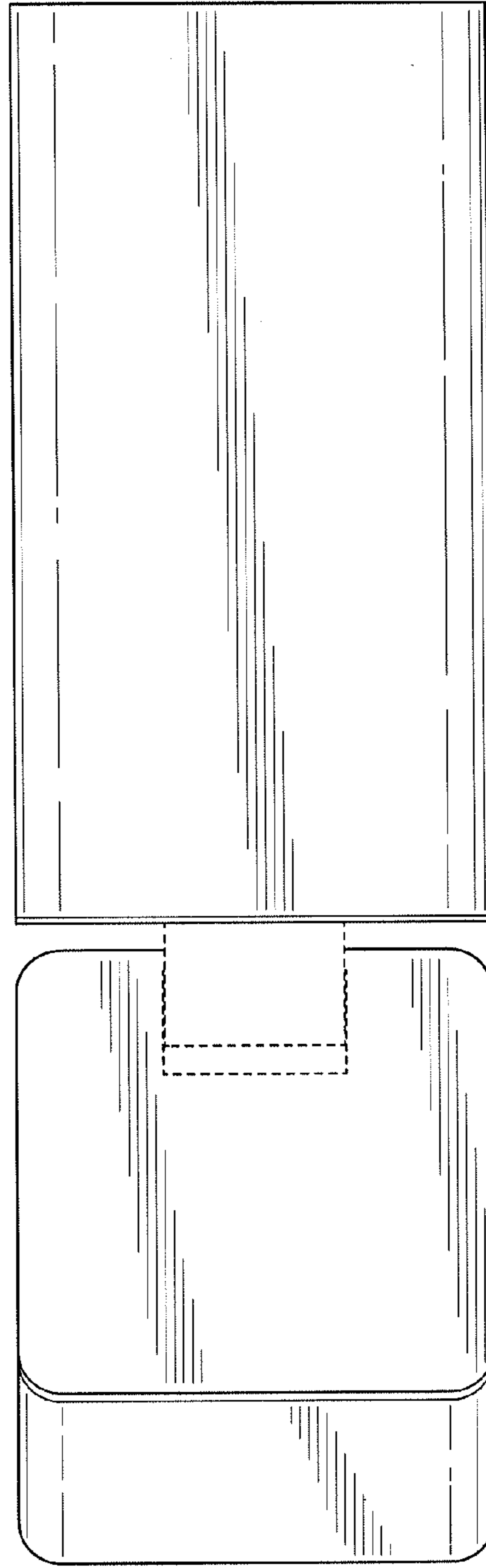

FIG. 3

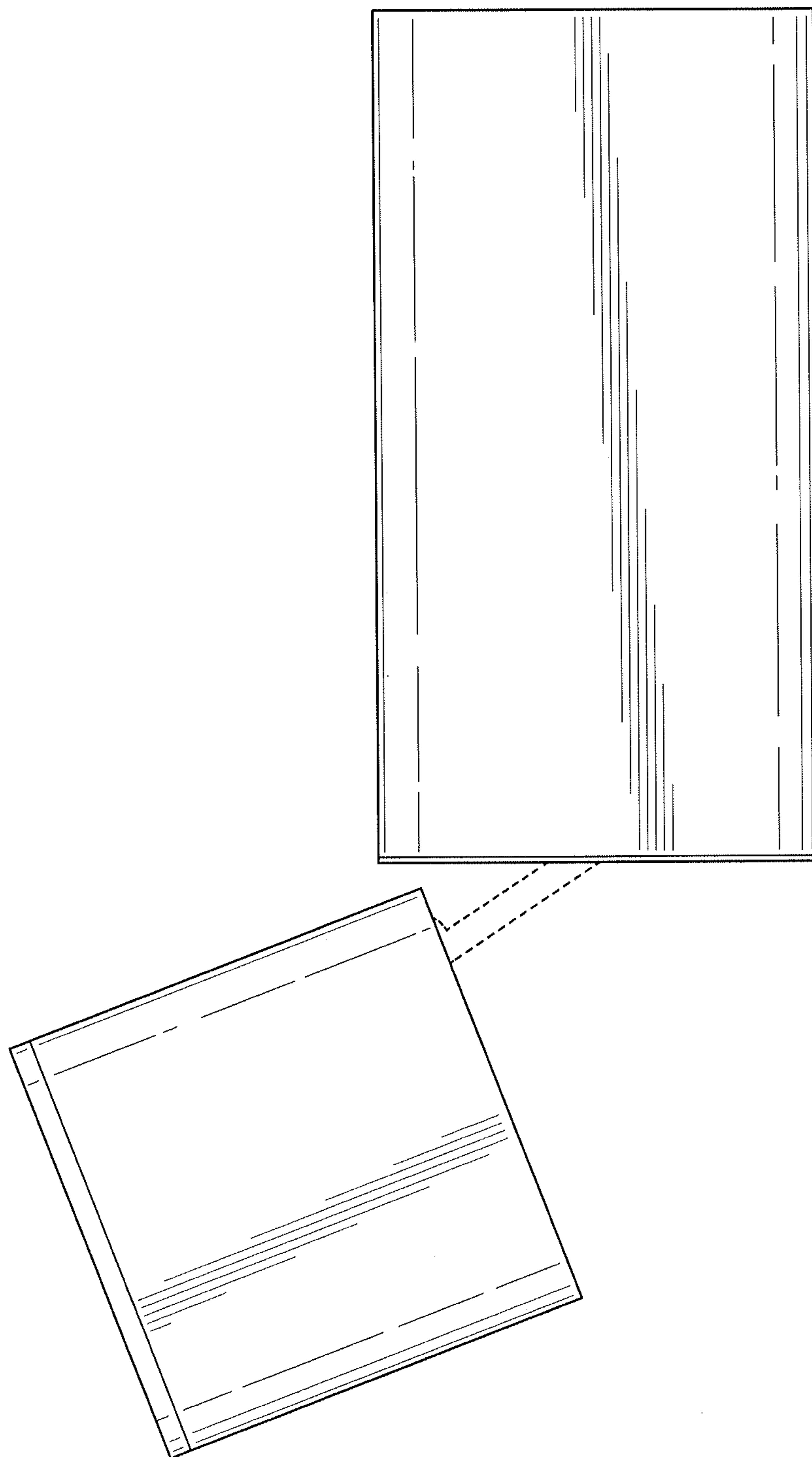

FIG. 4

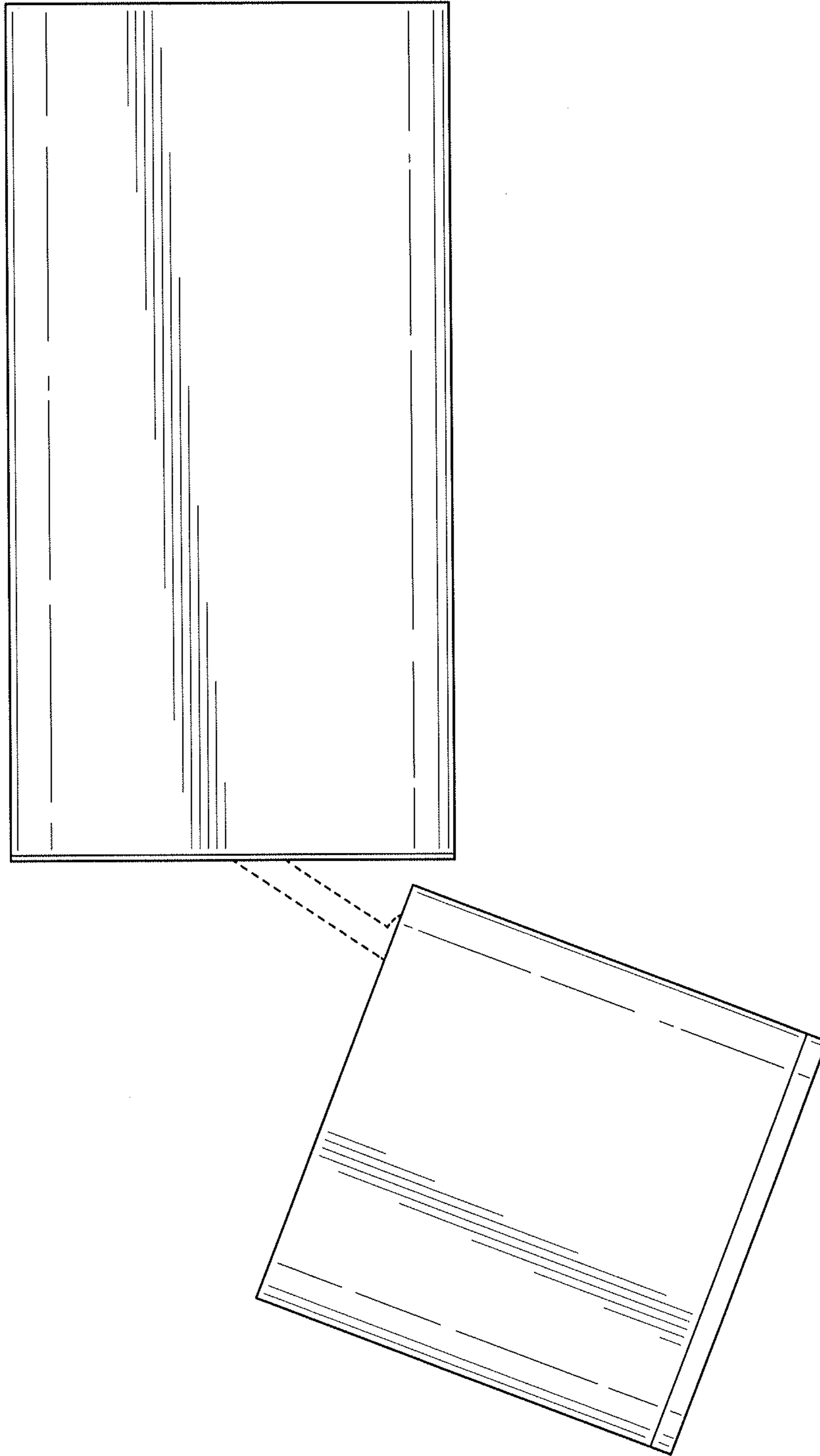

FIG. 5

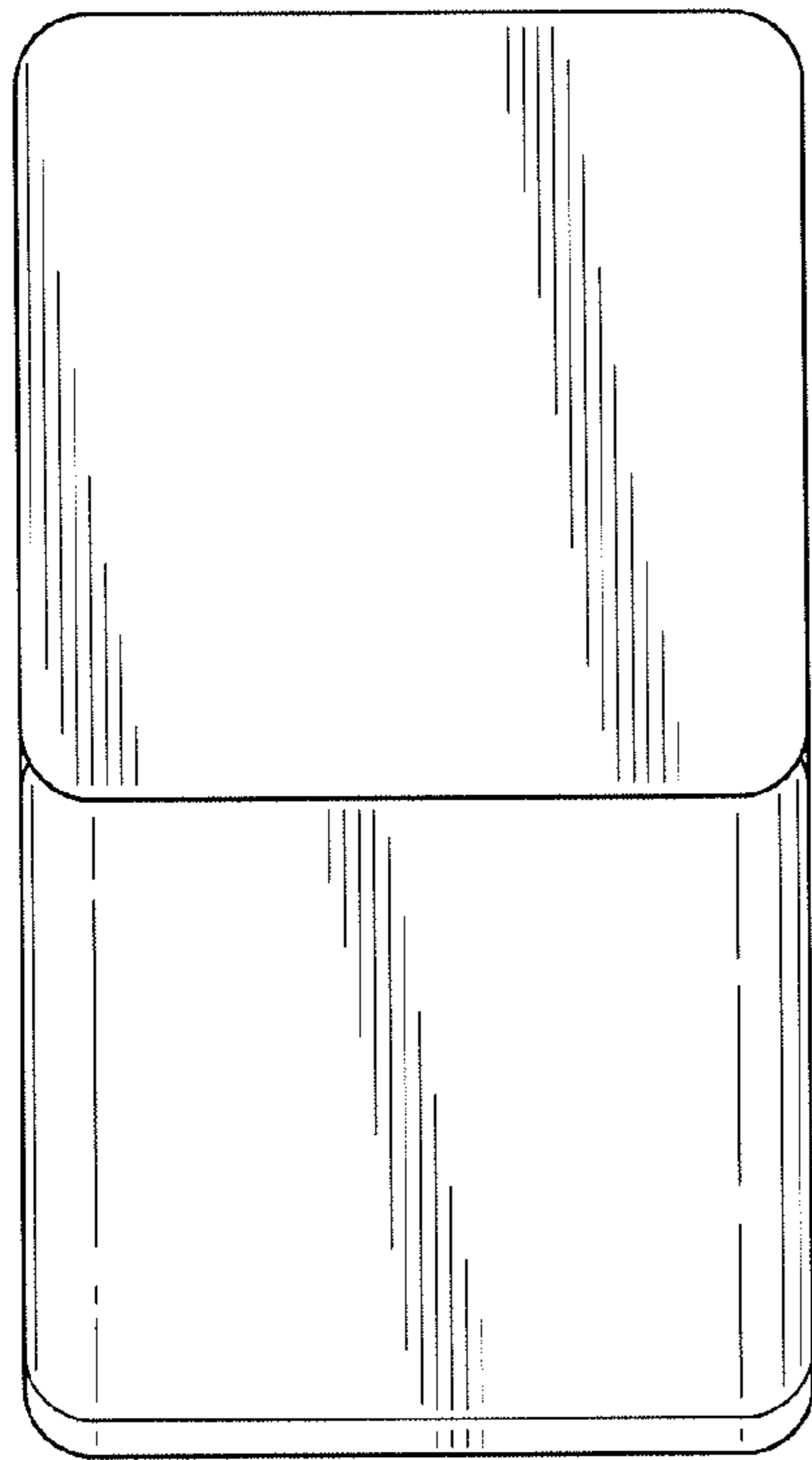

FIG. 6

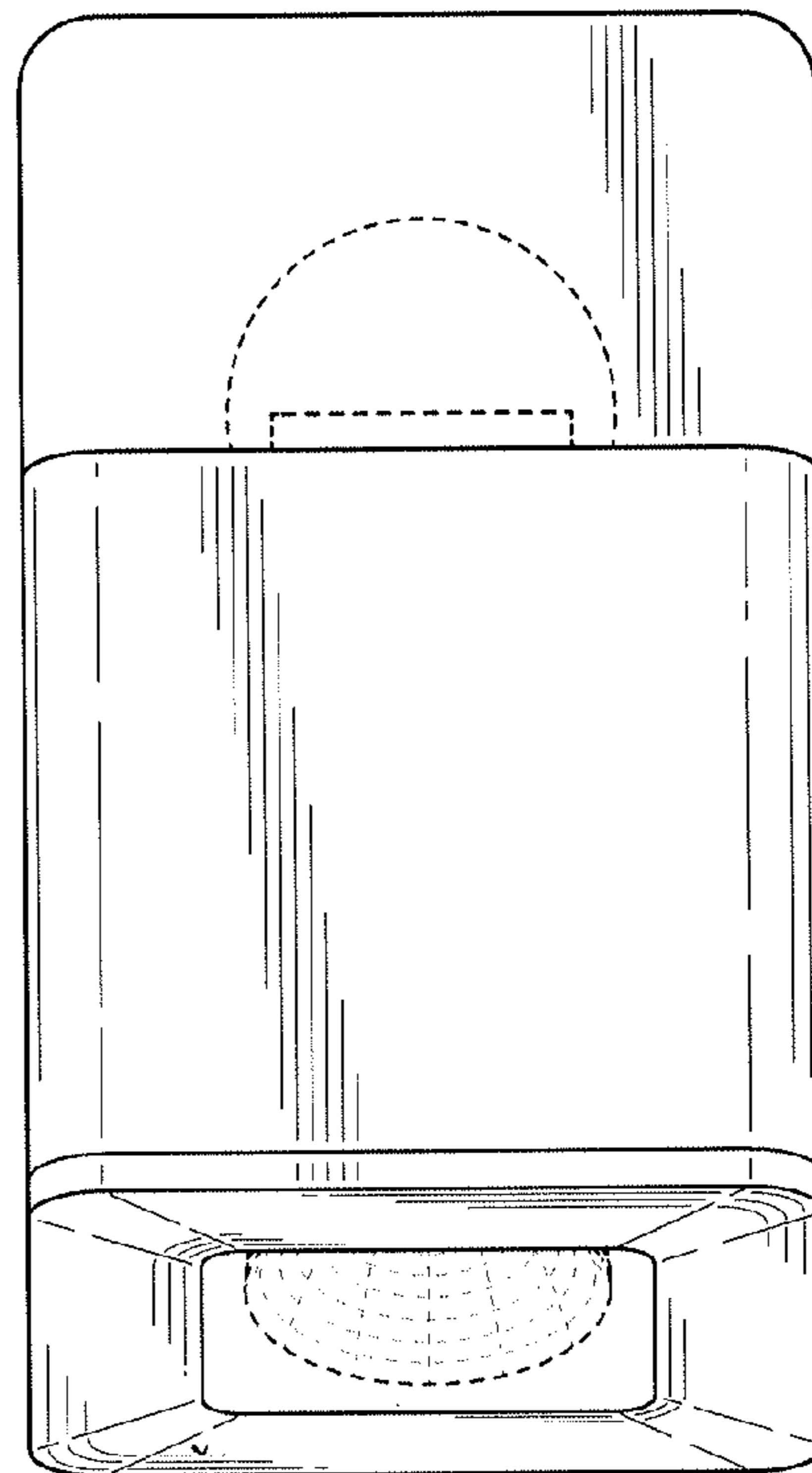

FIG. 7

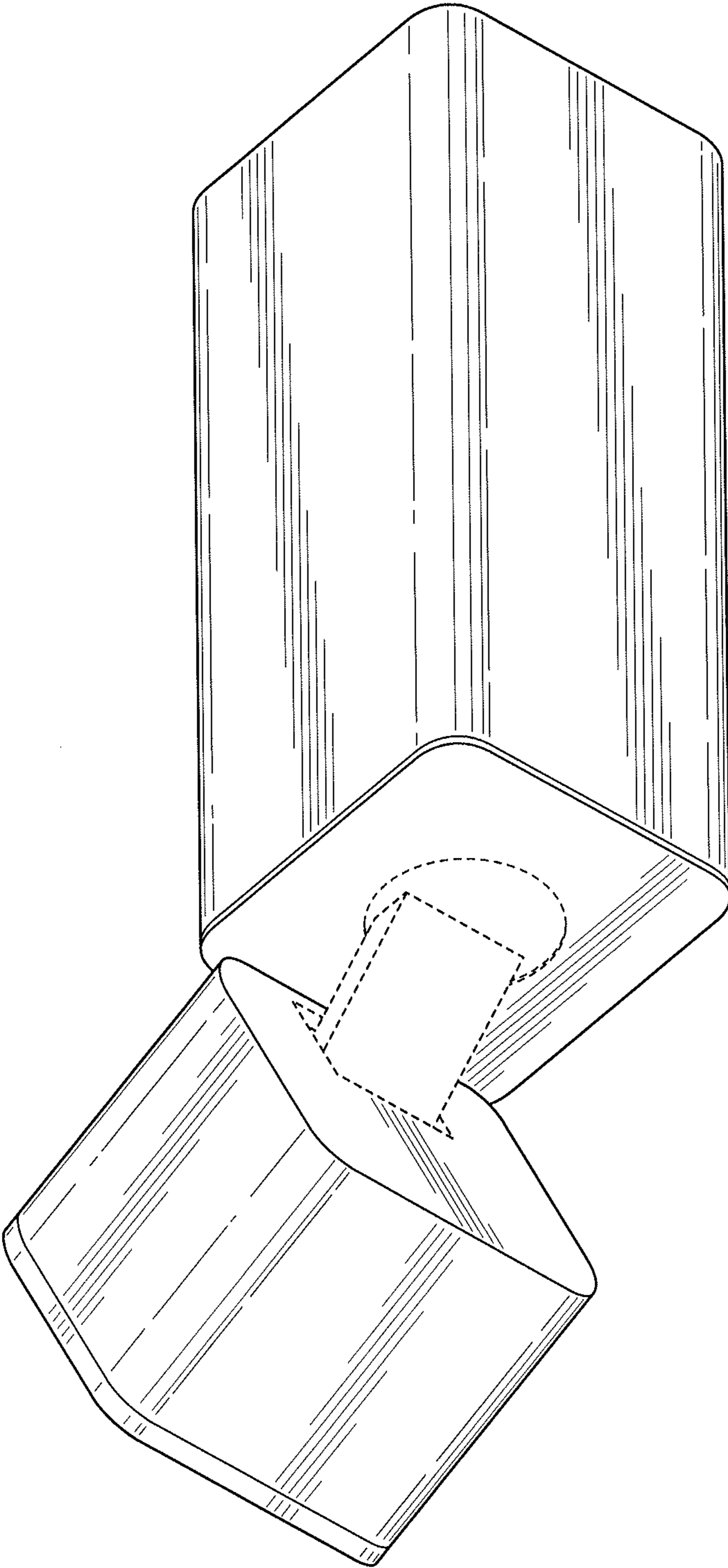

FIG. 8