



US00D733819S

(12) **United States Design Patent**  
**Dolezel et al.**

(10) **Patent No.:** **US D733,819 S**

(45) **Date of Patent:** **\*\* Jul. 7, 2015**

(54) **GOLF CLUB HEAD**

(71) Applicant: **DUNLOP SPORTS CO. LTD.**,  
Kobe-shi, Hyogo (JP)

(72) Inventors: **Keith Dolezel**, West Covina, CA (US);  
**Nick Trahan**, Huntington Beach, CA  
(US); **Phillip Seagram**, Long Beach, CA  
(US); **Mika Becktor**, Costa Mesa, CA  
(US)

(73) Assignee: **DUNLOP SPORTS CO. LTD.**,  
Kobe-shi (JP)

(\*\*) Term: **14 Years**

(21) Appl. No.: **29/494,482**

(22) Filed: **Jun. 20, 2014**

(51) **LOC (10) Cl.** ..... **21-02**

(52) **U.S. Cl.**  
USPC ..... **D21/747**

(58) **Field of Classification Search**  
USPC ..... D21/747-751, 759  
CPC ..... A63B 53/00; A63B 53/04; A63B 53/047;  
A63B 53/0475  
See application file for complete search history.

(56) **References Cited**

**U.S. PATENT DOCUMENTS**

D164,597 S \* 9/1951 Penna ..... D21/751  
D566,803 S \* 4/2008 Foster et al. .... D21/747  
D598,060 S \* 8/2009 Barez et al. .... D21/747  
D659,214 S \* 5/2012 Oldknow et al. .... D21/759

D669,947 S \* 10/2012 Kim et al. .... D21/747  
D684,228 S \* 6/2013 Breier et al. .... D21/749  
D691,685 S \* 10/2013 Cyrulik et al. .... D21/759  
D707,766 S \* 6/2014 Wolfe et al. .... D21/747  
D708,685 S \* 7/2014 Harvell et al. .... D21/747

\* cited by examiner

*Primary Examiner* — Mitchell Siegel  
(74) *Attorney, Agent, or Firm* — Oliff PLC

(57) **CLAIM**  
The ornamental design for a golf club head, as shown and described.

**DESCRIPTION**

FIG. 1 is a front elevational view of the golf club head;  
FIG. 2 is a rear elevational view thereof;  
FIG. 3 is a toe-side elevational view thereof;  
FIG. 4 is a heel-side elevational view thereof;  
FIG. 5 is a top plan view thereof;  
FIG. 6 is a bottom plan view thereof;  
FIG. 7 is a front, toe-side, top perspective view thereof;  
FIG. 8 is a front, heel-side, top perspective view thereof;  
FIG. 9 is a rear, toe-side, top perspective view thereof;  
FIG. 10 is a rear, heel-side, top perspective view thereof;  
FIG. 11 is a rear, heel-side, bottom perspective view thereof;  
FIG. 12 is a rear, toe-side, bottom perspective view thereof;  
and,  
FIG. 13 is a cross-sectional view taken along line 13-13 in FIG. 2.

The broken lines depict environmental subject matter and form no part of the claimed design.

**1 Claim, 11 Drawing Sheets**

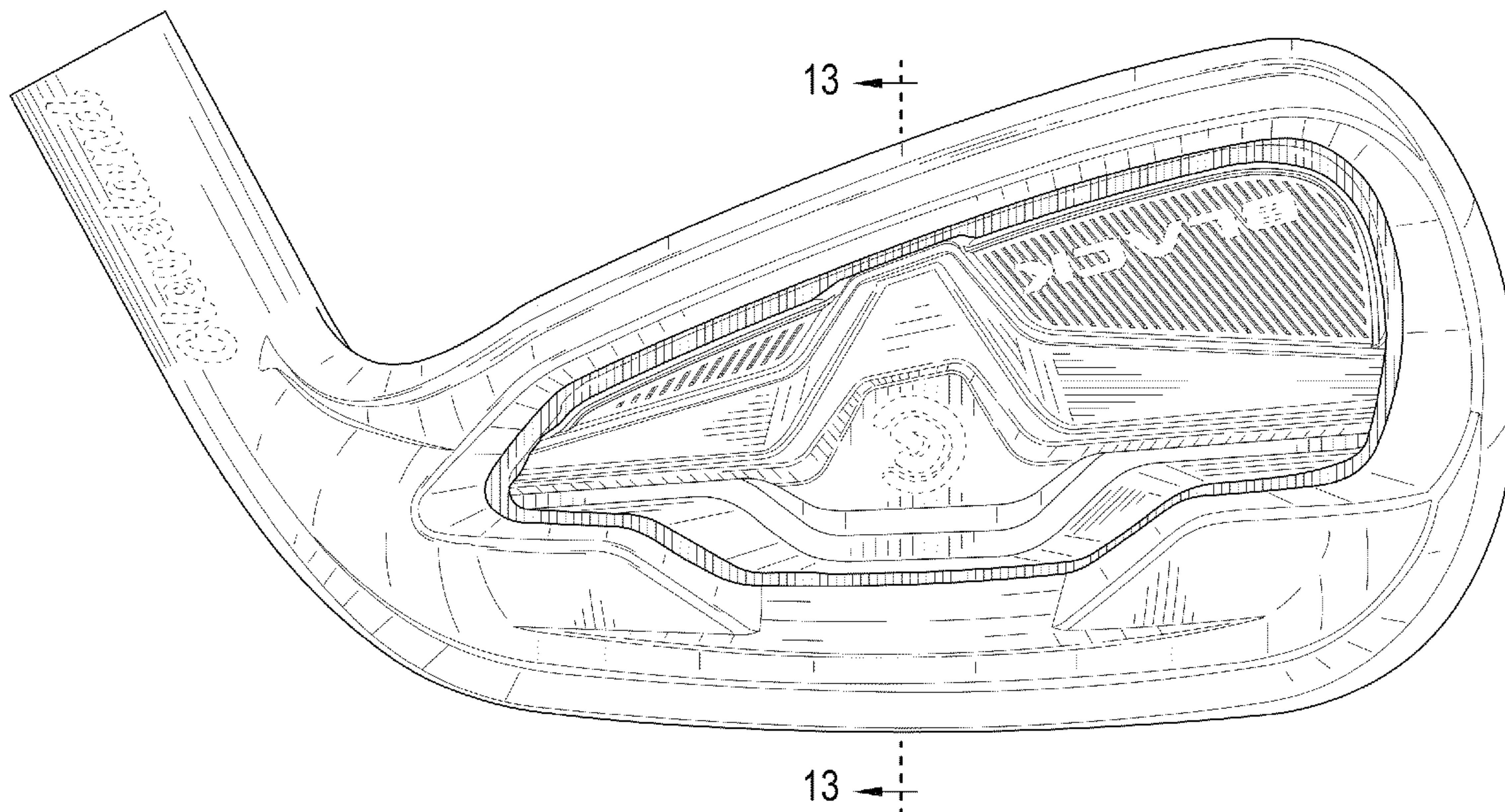

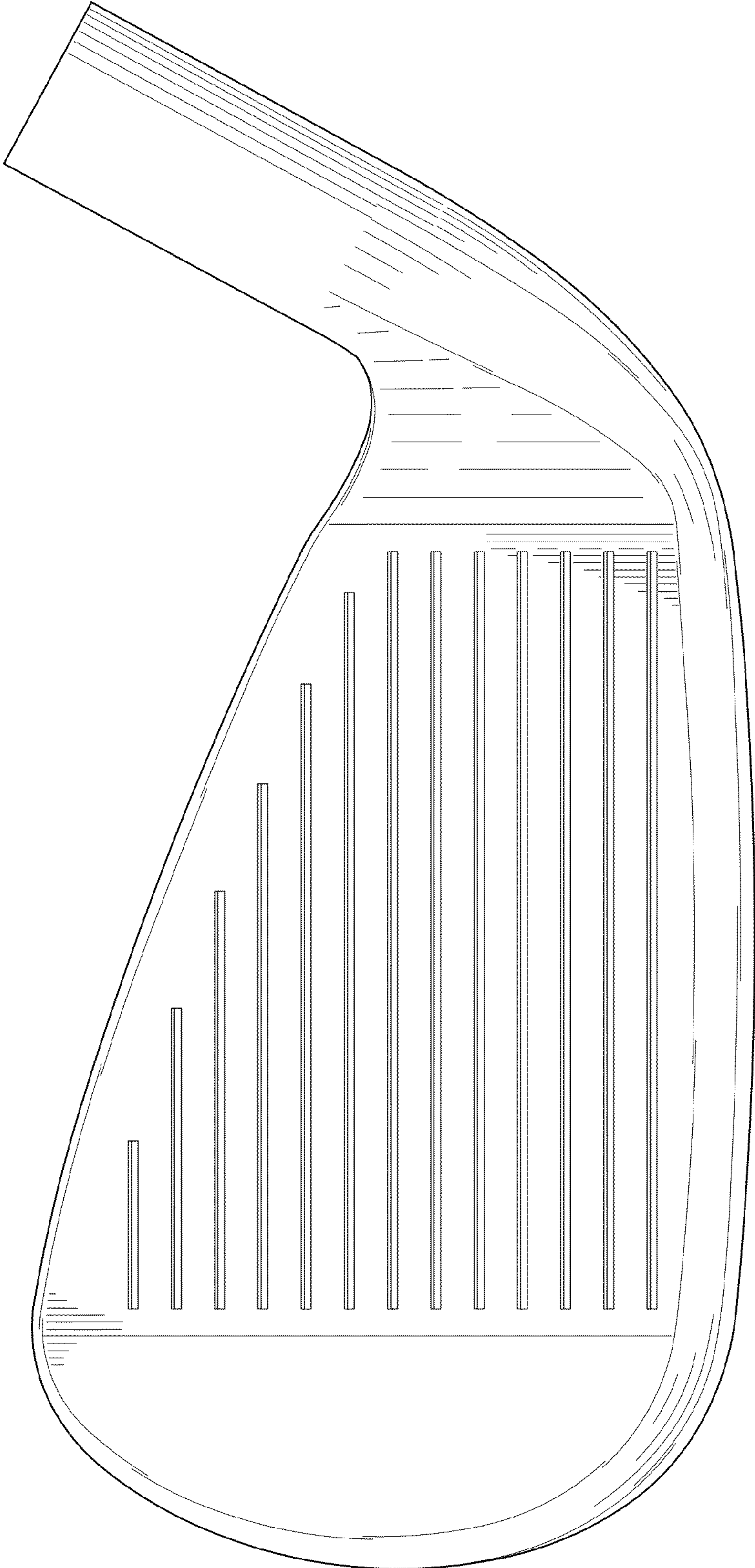

FIG. 1



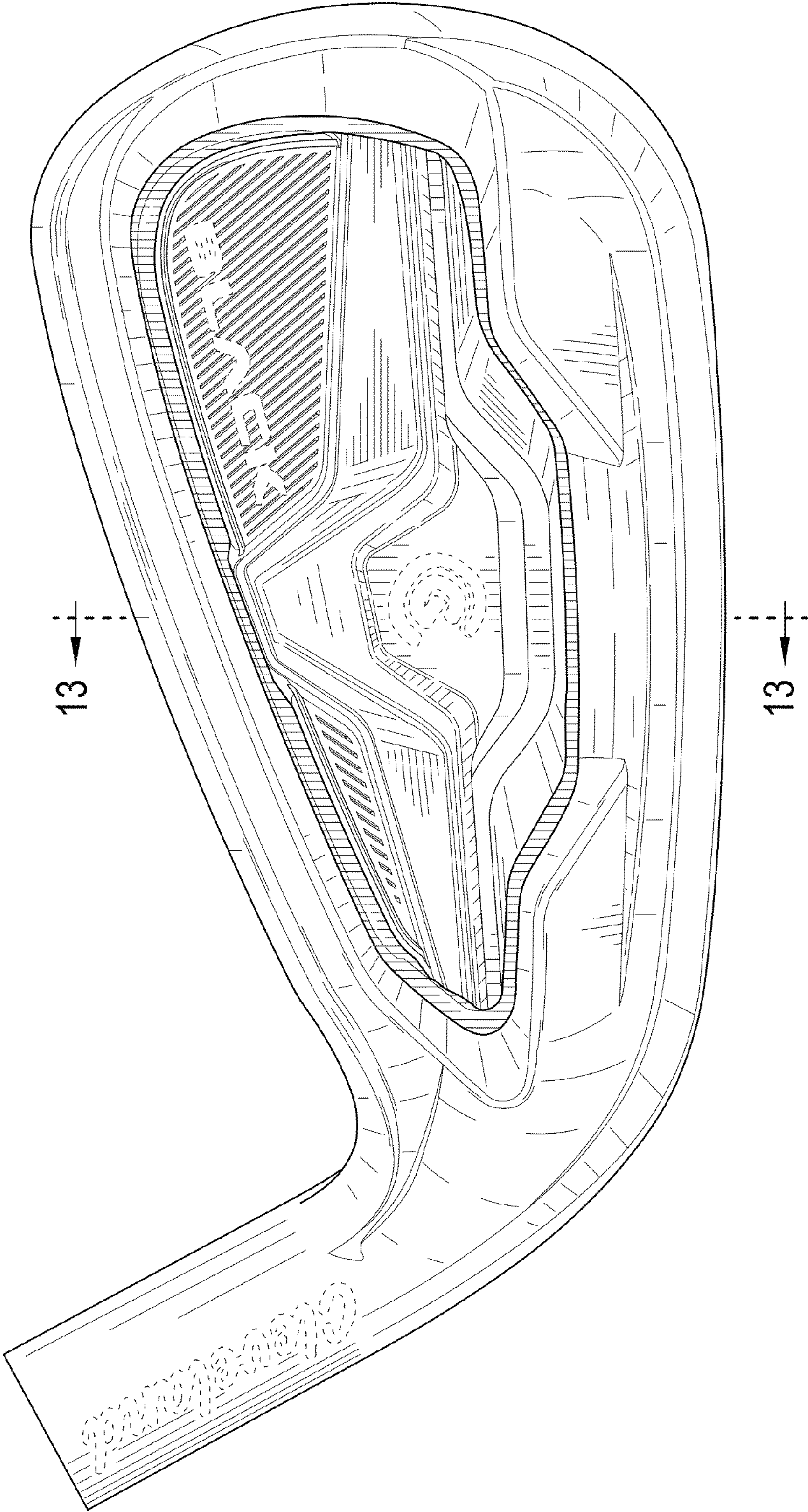

FIG. 2

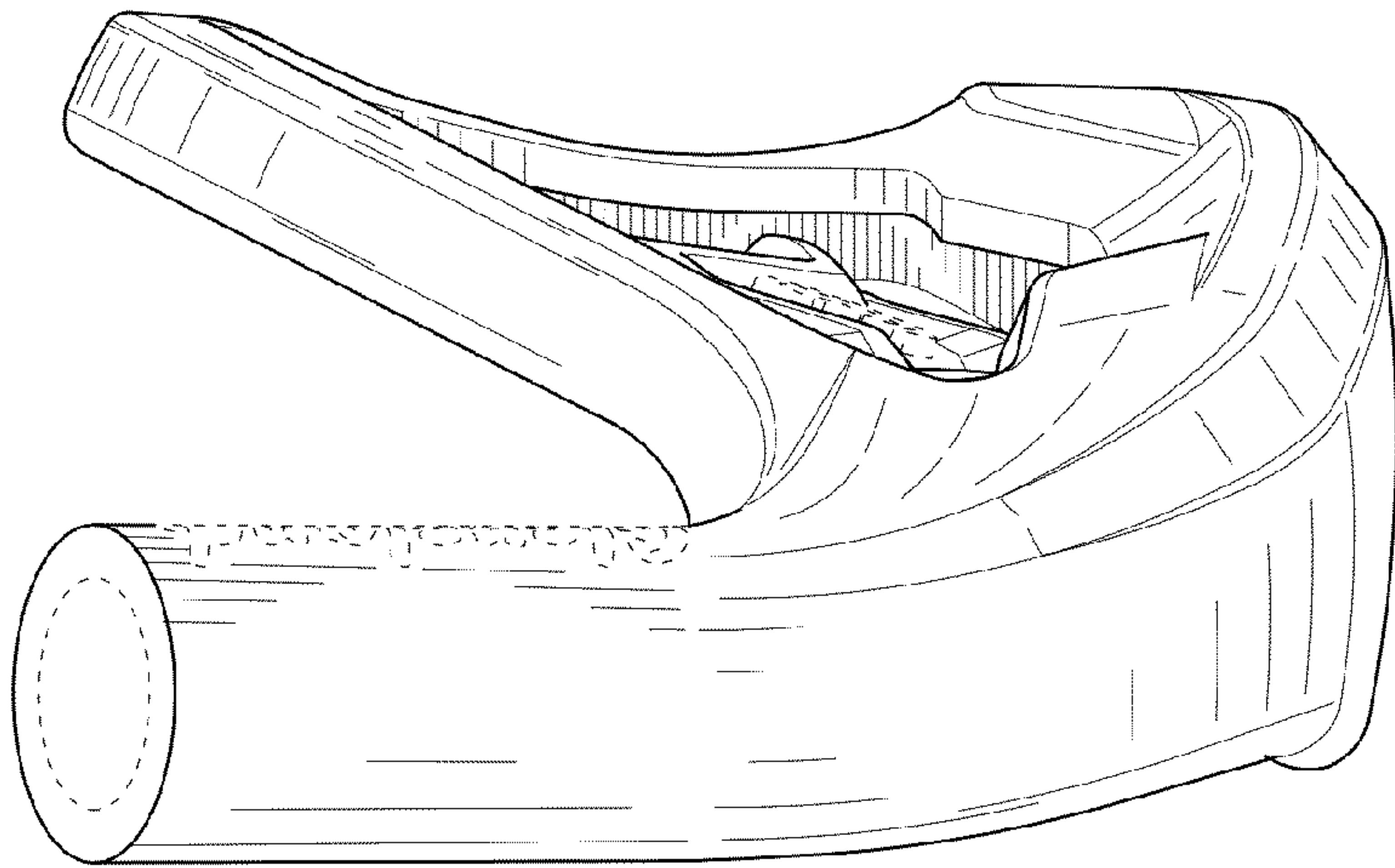

FIG. 4

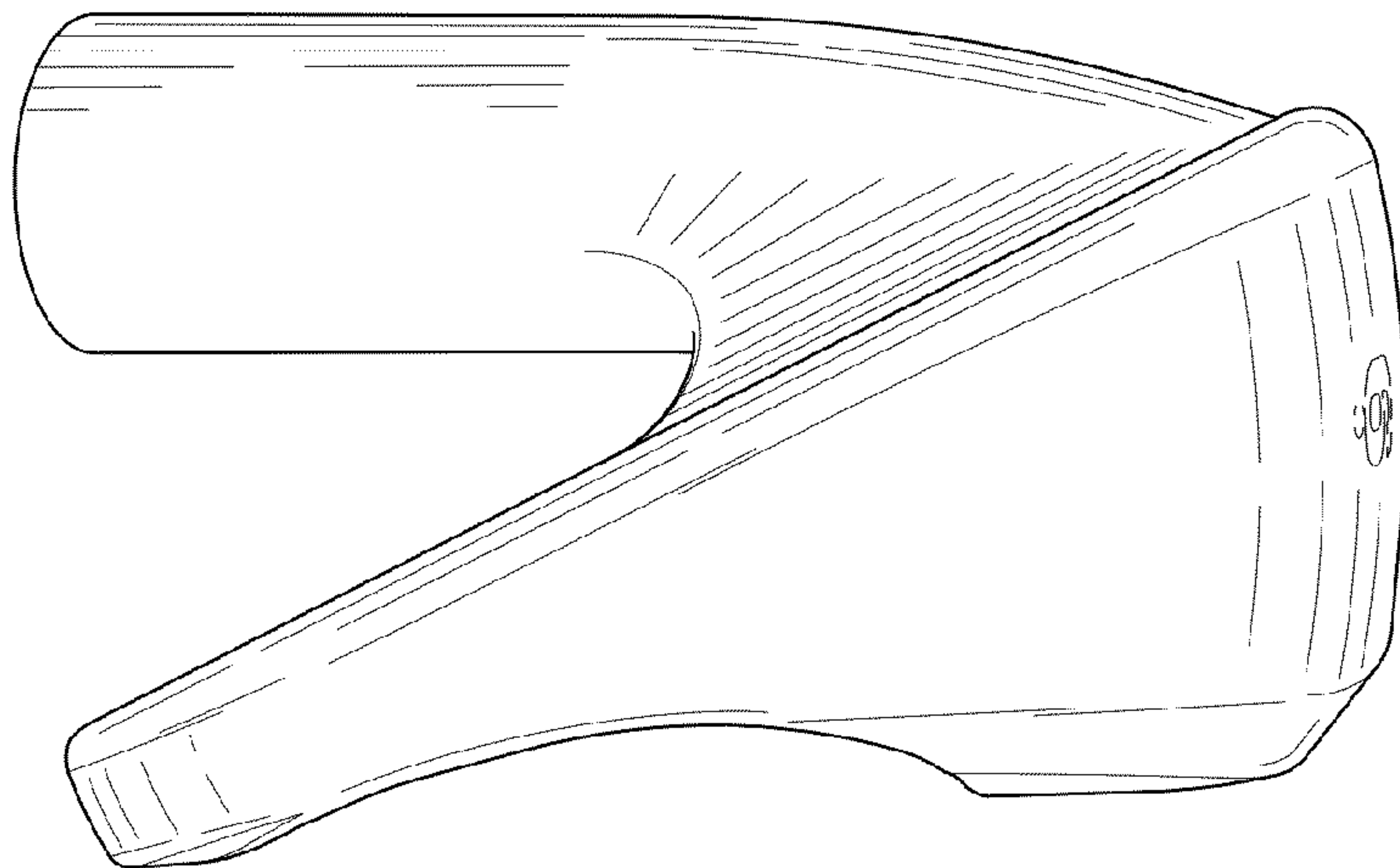

FIG. 3

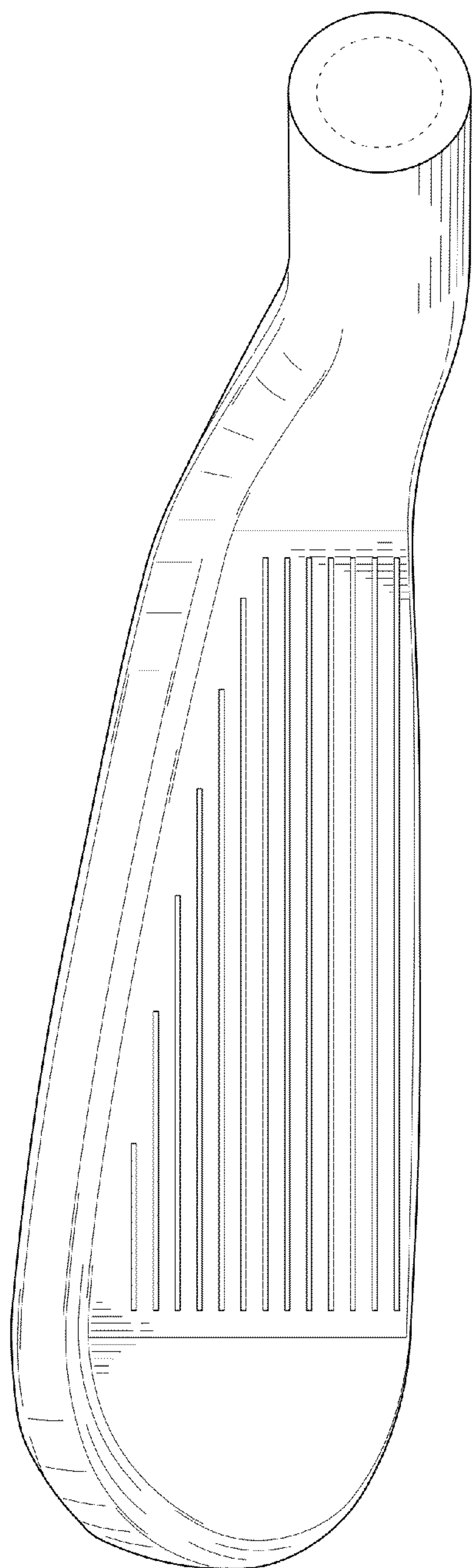

FIG. 5

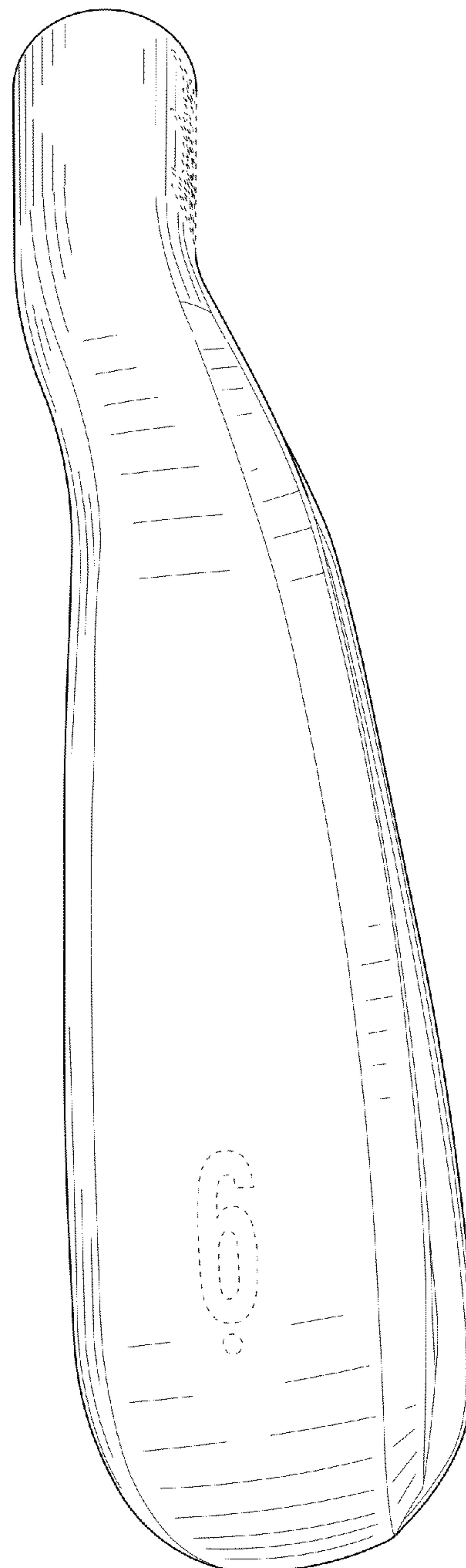

FIG. 6



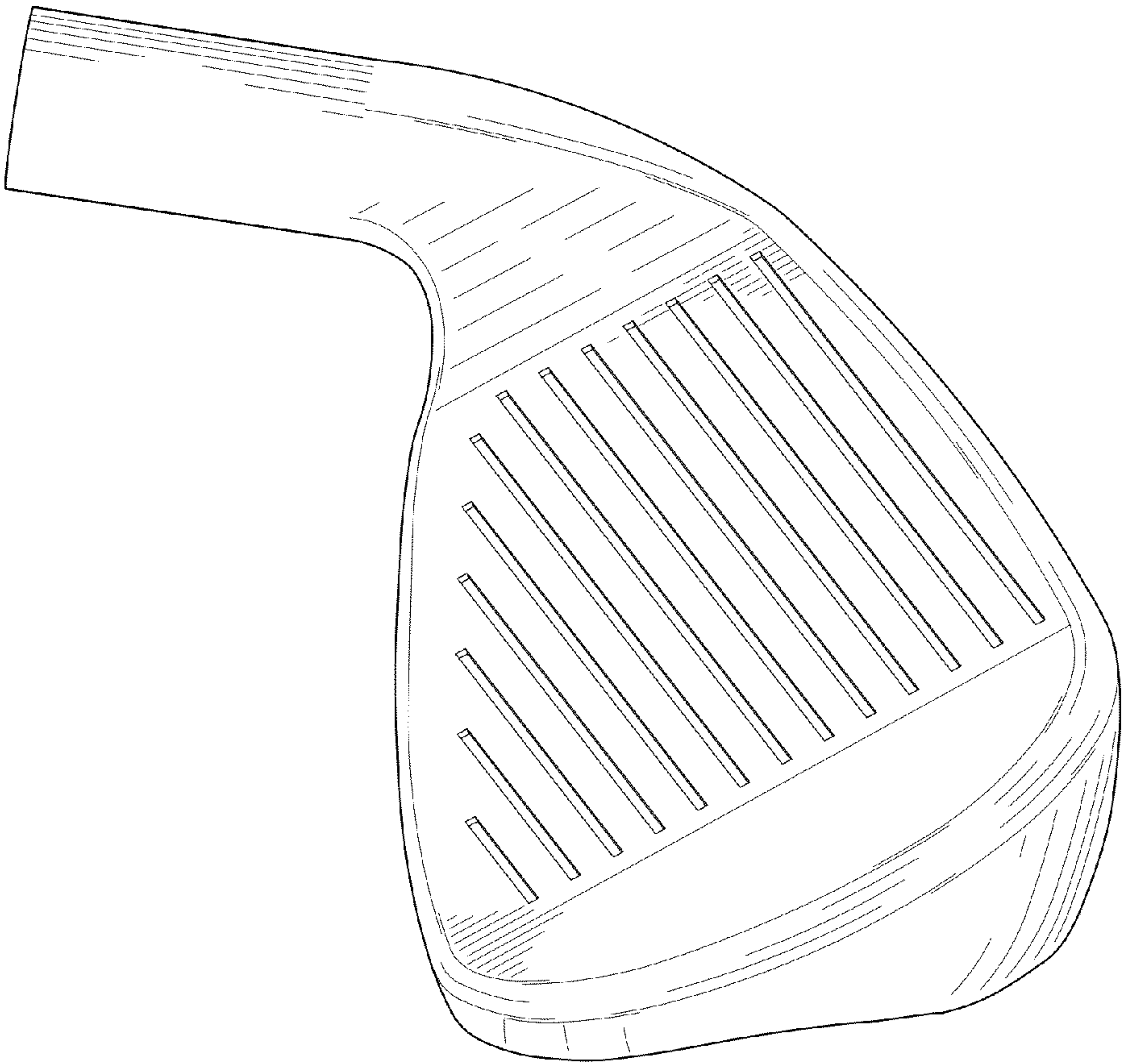

FIG. 7

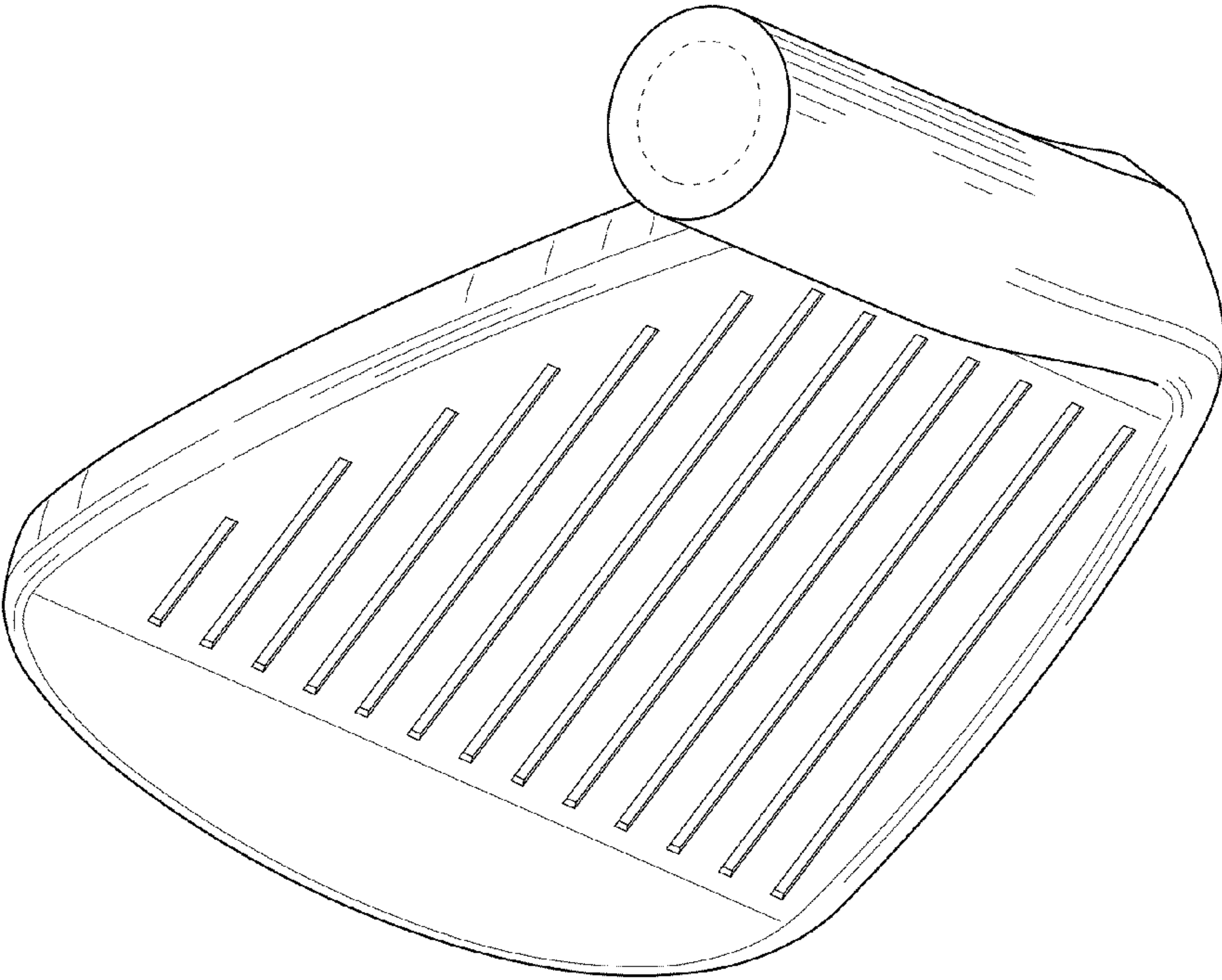

FIG. 8

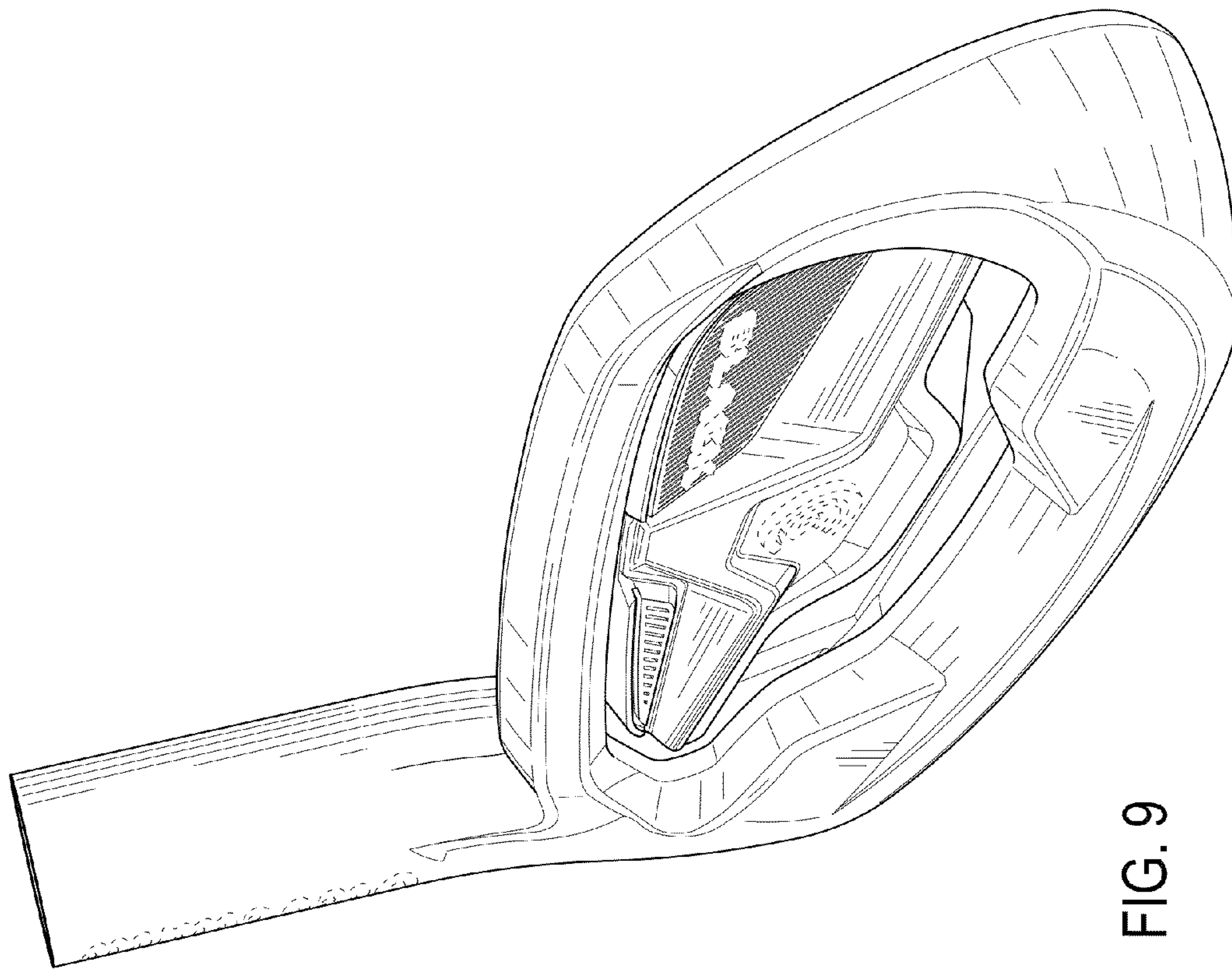

FIG. 9



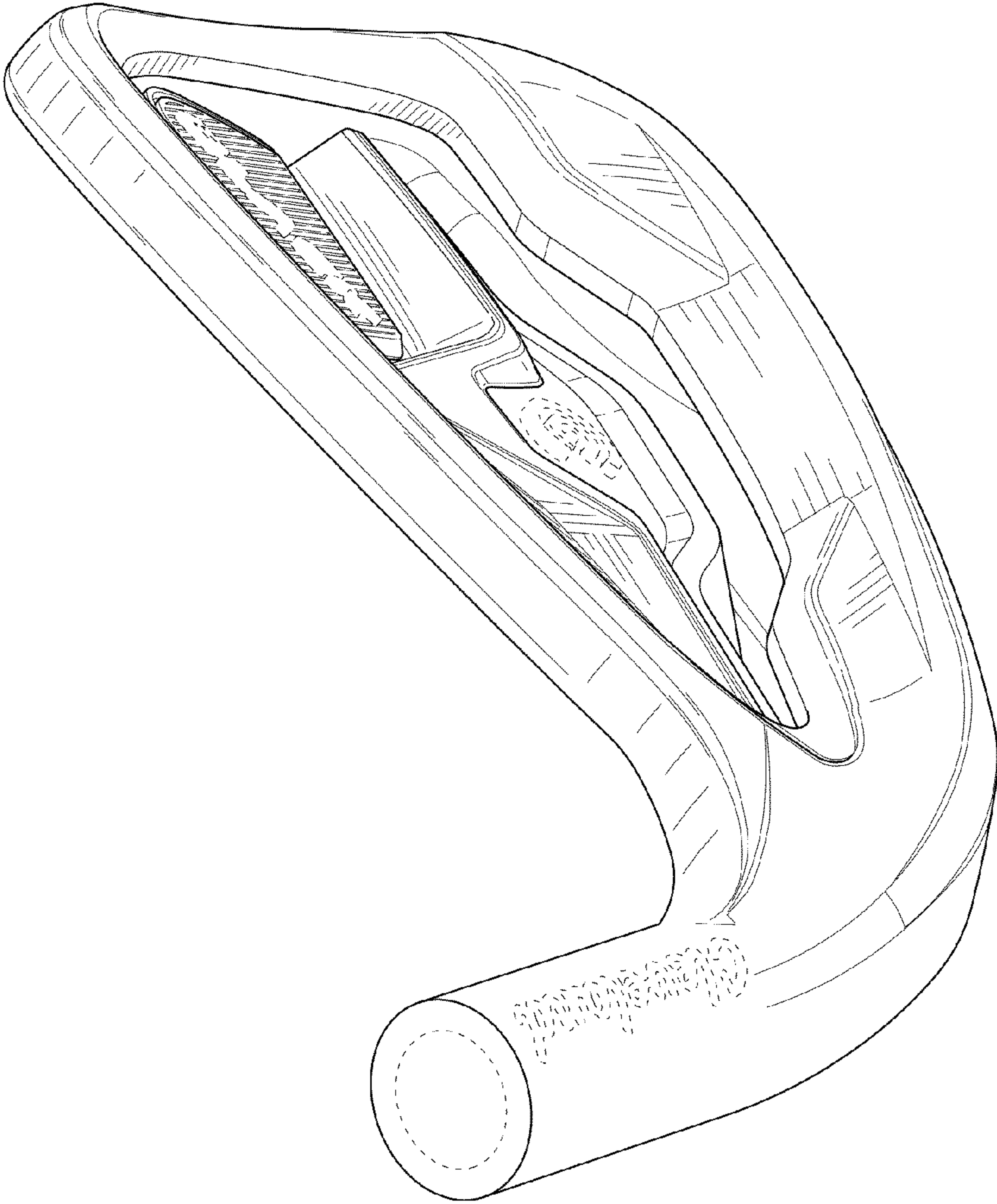

FIG. 10

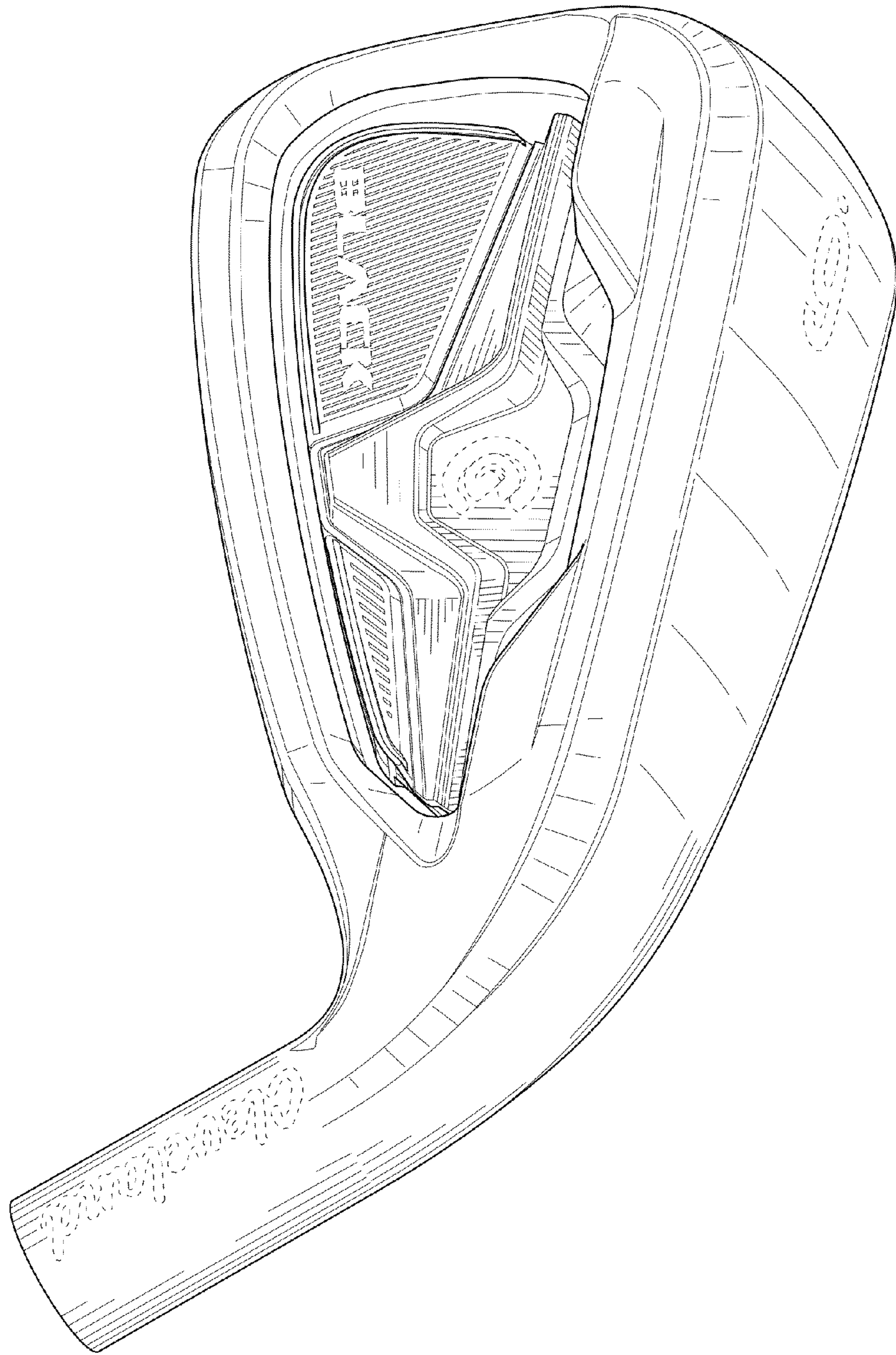

FIG. 11

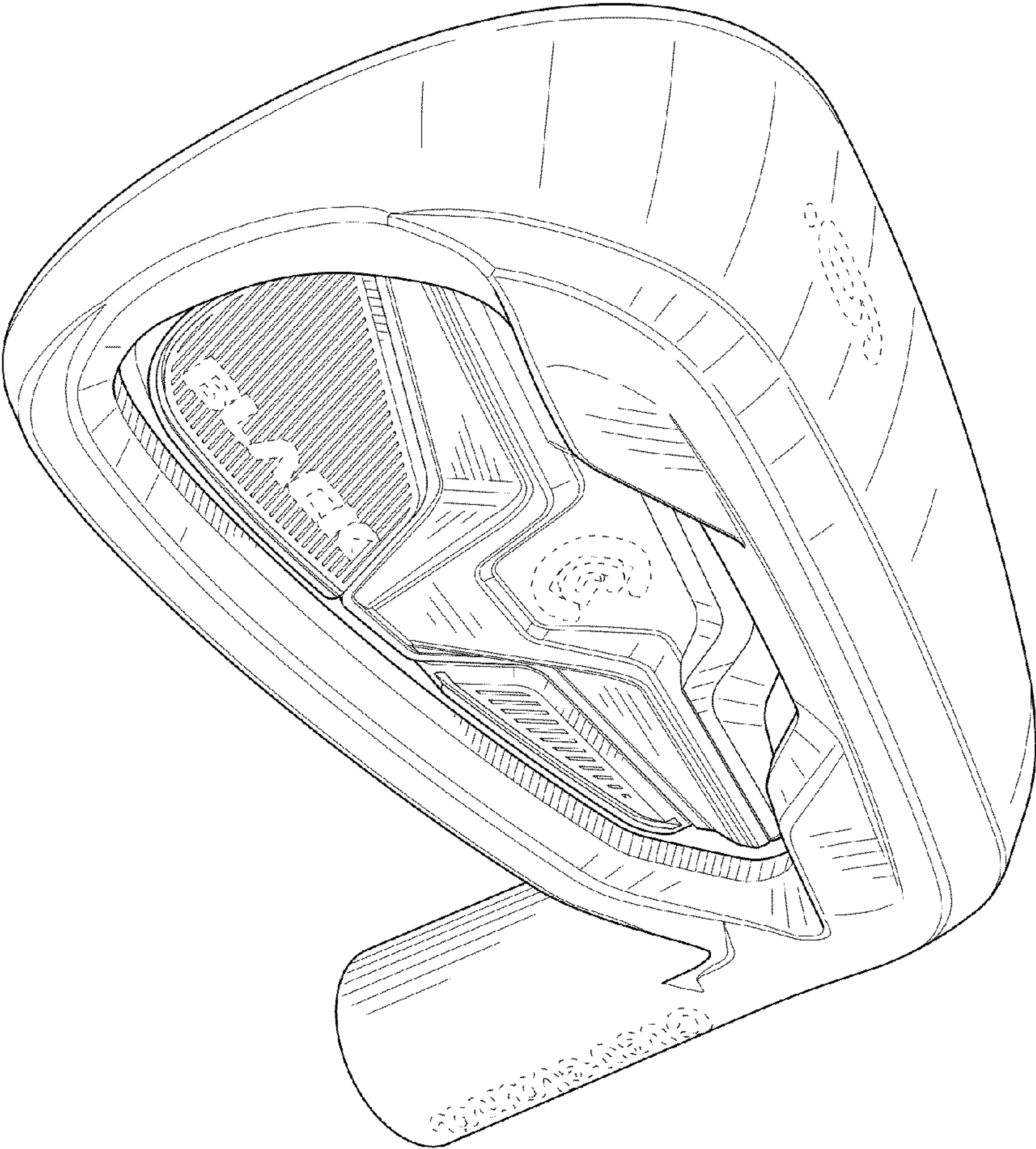

FIG. 12



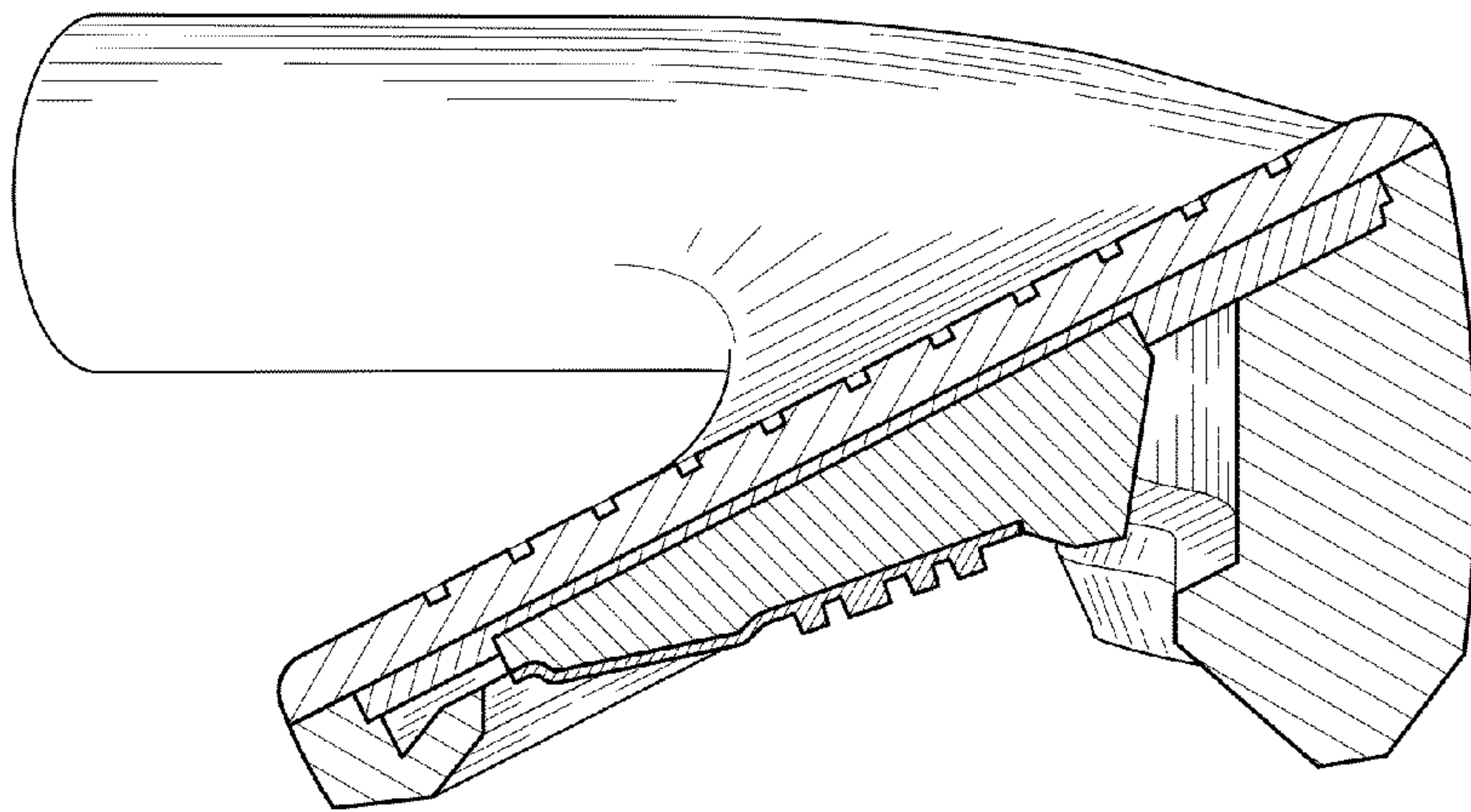

FIG. 13