



US00D733797S

(12) **United States Design Patent**  
**Pryor**

(10) **Patent No.:** **US D733,797 S**  
(45) **Date of Patent:** **\*\* Jul. 7, 2015**

(54) **INDEXING TAB**

(71) Applicant: **Daniel Lee Pryor**, Bothell, WA (US)

(72) Inventor: **Daniel Lee Pryor**, Bothell, WA (US)

(\*\*) Term: **14 Years**

(21) Appl. No.: **29/459,461**

(22) Filed: **Jun. 28, 2013**

(51) **LOC (10) Cl.** ..... **19-01**

(52) **U.S. Cl.**  
USPC ..... **D19/1**

(58) **Field of Classification Search**

USPC ..... D19/1-12, 20-34, 78, 87, 91, 100;  
428/77, 43, 40.1, 42.2, 40.3, 192, 194;  
156/182, 60; 206/425, 449; 281/3.1,  
281/38, 21.1, 15.1, 16; 283/63.1, 64.1, 117,  
283/61, 62, 60.2, 40, 101, 81; D6/582-594,  
D6/596; 462/901, 72, 61; 412/1-8, 10;  
211/11, 45, 50; 40/124.01-124.15,  
40/121, 119

See application file for complete search history.

(56) **References Cited**

U.S. PATENT DOCUMENTS

D667,494 S *	9/2012	Sato et al.	.....	D19/1
D679,753 S *	4/2013	Sato et al.	.....	D19/1
D680,166 S *	4/2013	Sato et al.	.....	D19/1
D681,110 S *	4/2013	Sato et al.	.....	D19/1
D681,111 S *	4/2013	Sato et al.	.....	D19/1
D690,351 S *	9/2013	Sato et al.	.....	D19/1

\* cited by examiner

*Primary Examiner* — Caron D Veynar

*Assistant Examiner* — Abraham Bahta

(74) *Attorney, Agent, or Firm* — Barry L. Davison; Davis Wright Tremaine, LLP

(57) **CLAIM**

The ornamental design for an indexing tab, as shown and described.

**DESCRIPTION**

FIG. 1 is a bottom front perspective view of a first embodiment of an indexing tab showing my new design, with an optional layer on the back of the lower tab portion.

FIG. 2 is a top rear perspective view thereof.

FIG. 3 is a front elevational view thereof.

FIG. 4 is a rear elevational view thereof.

FIG. 5 is a bottom front perspective view thereof, in partially folded configuration.

FIG. 6 is a top rear perspective view thereof, in partially folded configuration.

FIG. 7 is a bottom front perspective view thereof, in completely folded configuration.

FIG. 8 is a top rear perspective view thereof, in completely folded configuration.

FIG. 9 is a front elevational view thereof, in completely folded configuration.

FIG. 10 is a rear elevational view thereof, in completely folded configuration.

FIG. 11 is an enlargement of a portion of the view of FIG. 7. FIG. 12 is a bottom front perspective view of a second embodiment of an indexing tab showing my new design, with an optional layer on the back of the lower tab portion.

FIG. 13 is a top rear perspective view thereof.

FIG. 14 is a front elevational view thereof.

FIG. 15 is a rear elevational view thereof.

FIG. 16 is a bottom front perspective view thereof, in partially folded configuration.

FIG. 17 is a top rear perspective view thereof, in partially folded configuration.

FIG. 18 is a bottom front perspective view thereof, in completely folded configuration.

FIG. 19 is a top rear perspective view thereof, in completely folded configuration.

FIG. 20 is a front elevational view thereof, in completely folded configuration.

FIG. 21 is a rear elevational view thereof, in completely folded configuration.

FIG. 22 is a bottom front perspective view of a third embodiment of an indexing tab showing my new design, with an optional layer on the back of the lower tab portion.

FIG. 23 is a top rear perspective view thereof.

FIG. 24 is a front elevational view thereof.

FIG. 25 is a rear elevational view thereof.

FIG. 26 is a bottom front perspective view thereof, in partially folded configuration.

FIG. 27 is a top rear perspective view thereof, in partially folded configuration.

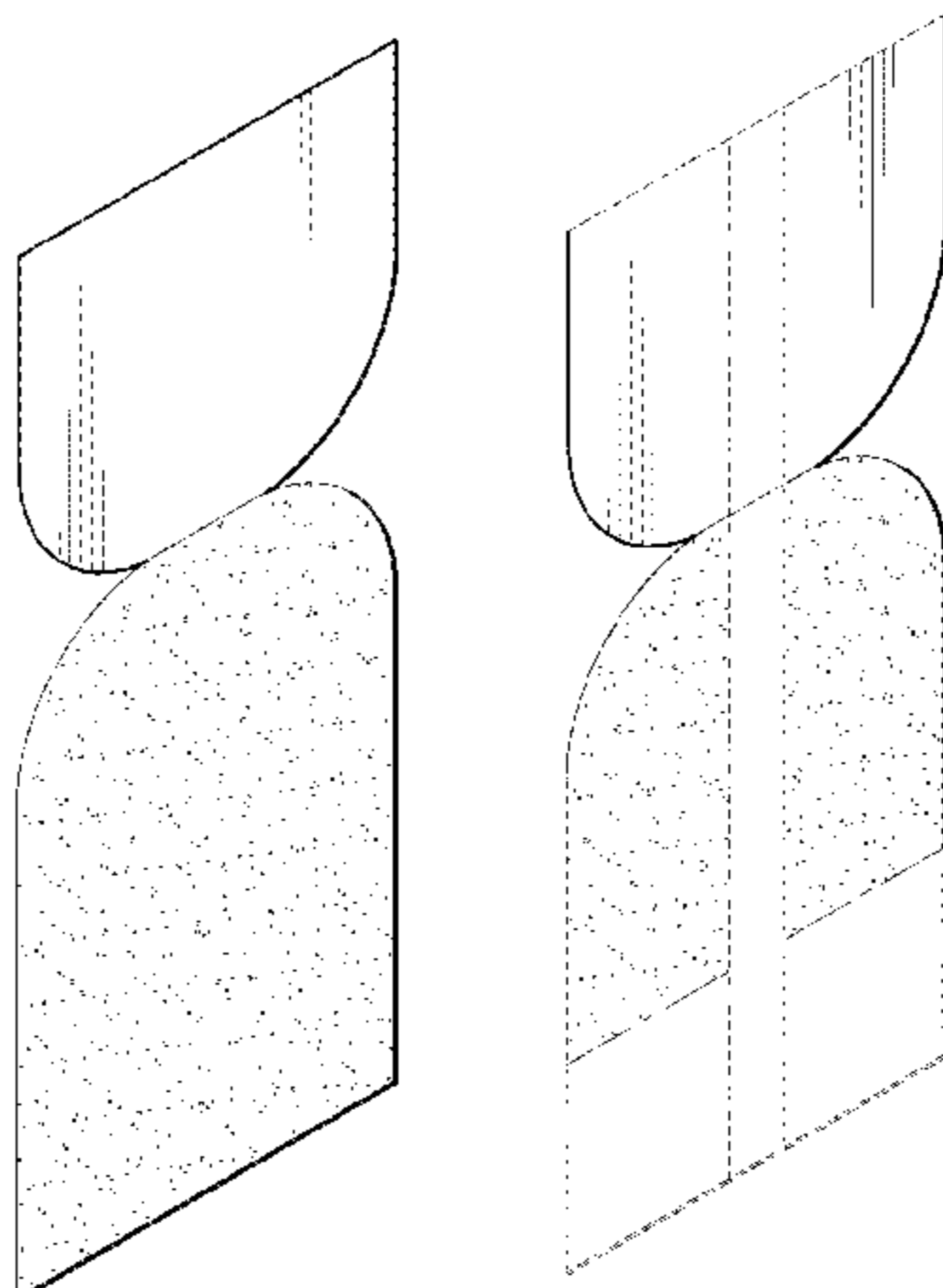


FIG. **28** is a bottom front perspective view thereof, in completely folded configuration.

FIG. **29** is a top rear perspective view thereof, in completely folded configuration.

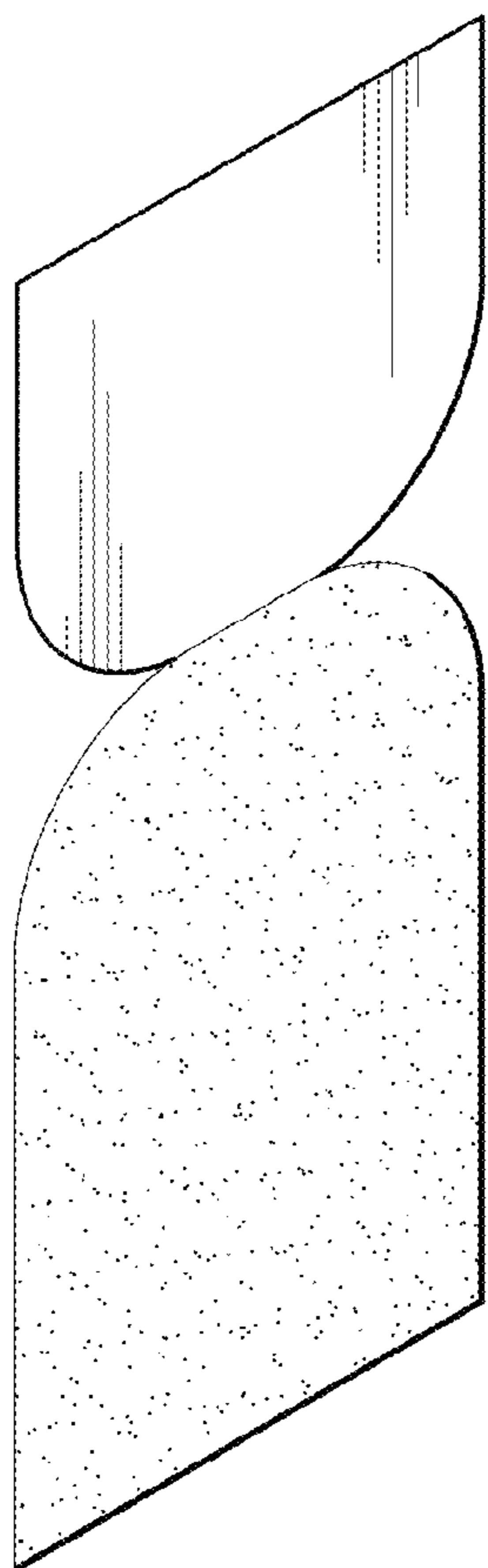
FIG. **30** is a front elevational view thereof, in completely folded configuration; and,

FIG. **31** is a rear elevational view thereof, in completely folded configuration.

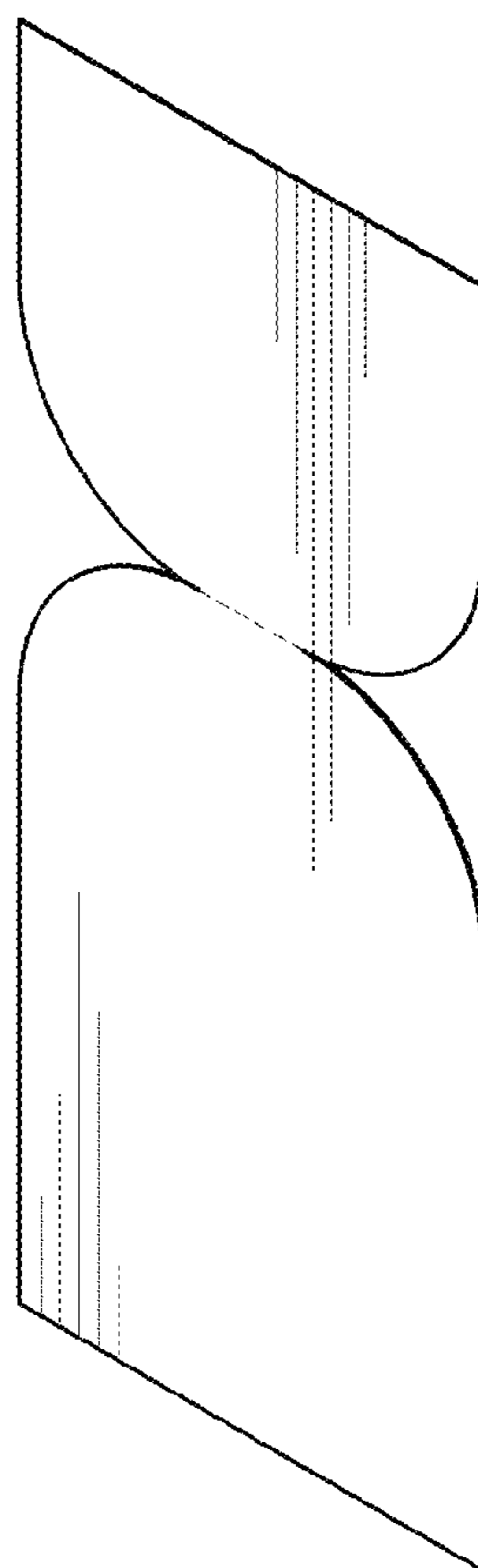
The broken lines are for the purpose of illustrating the environment of the design only and form no part of the claimed design.

The dash-dot lines represent boundaries and form no part thereof.

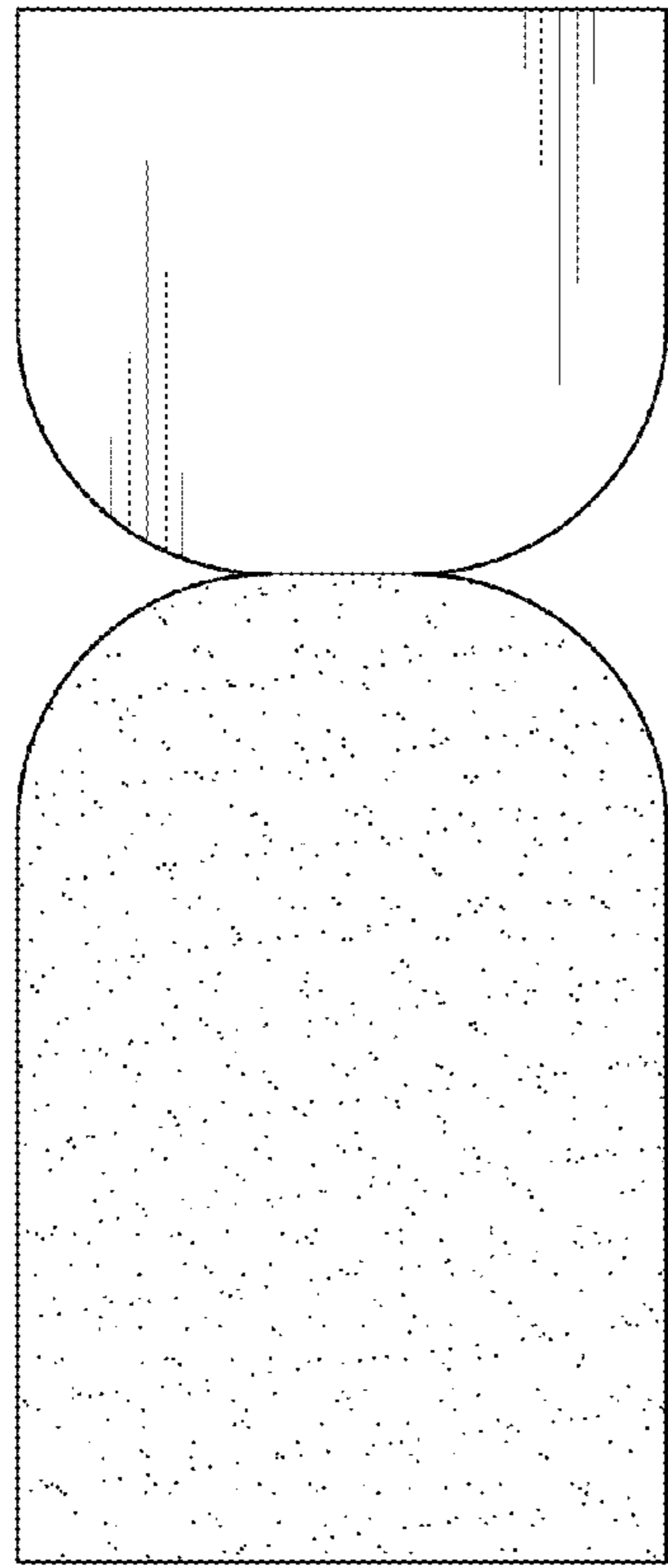
**1 Claim, 9 Drawing Sheets**



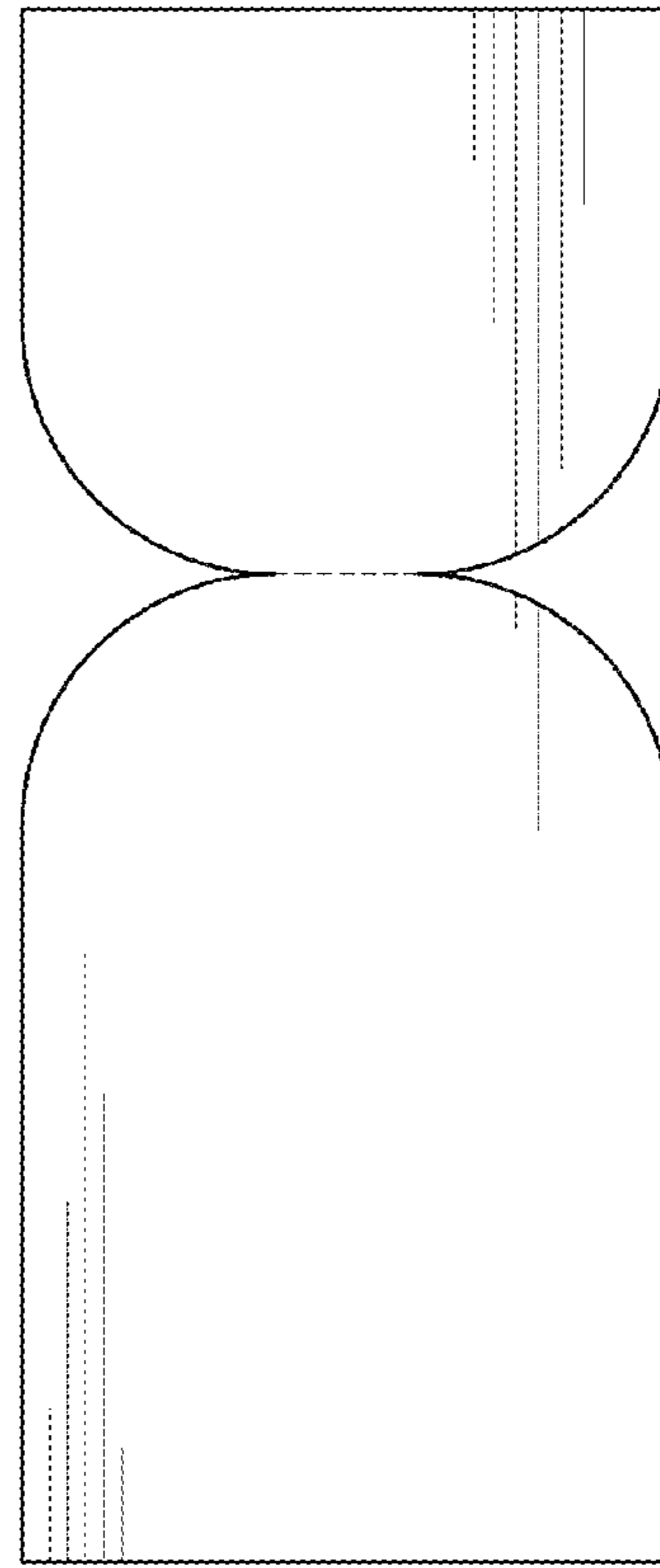
*Fig. 1*



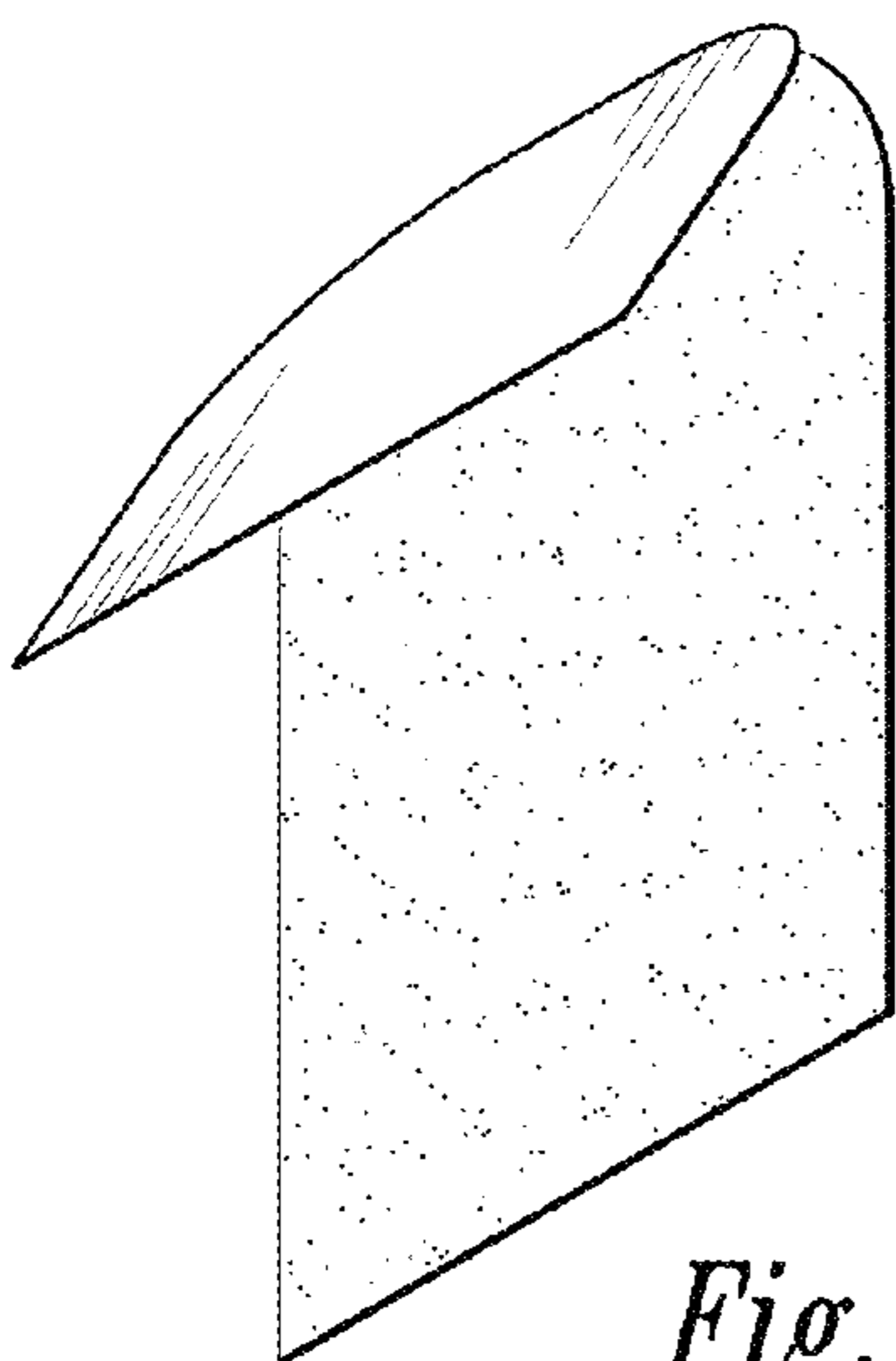
*Fig. 2*



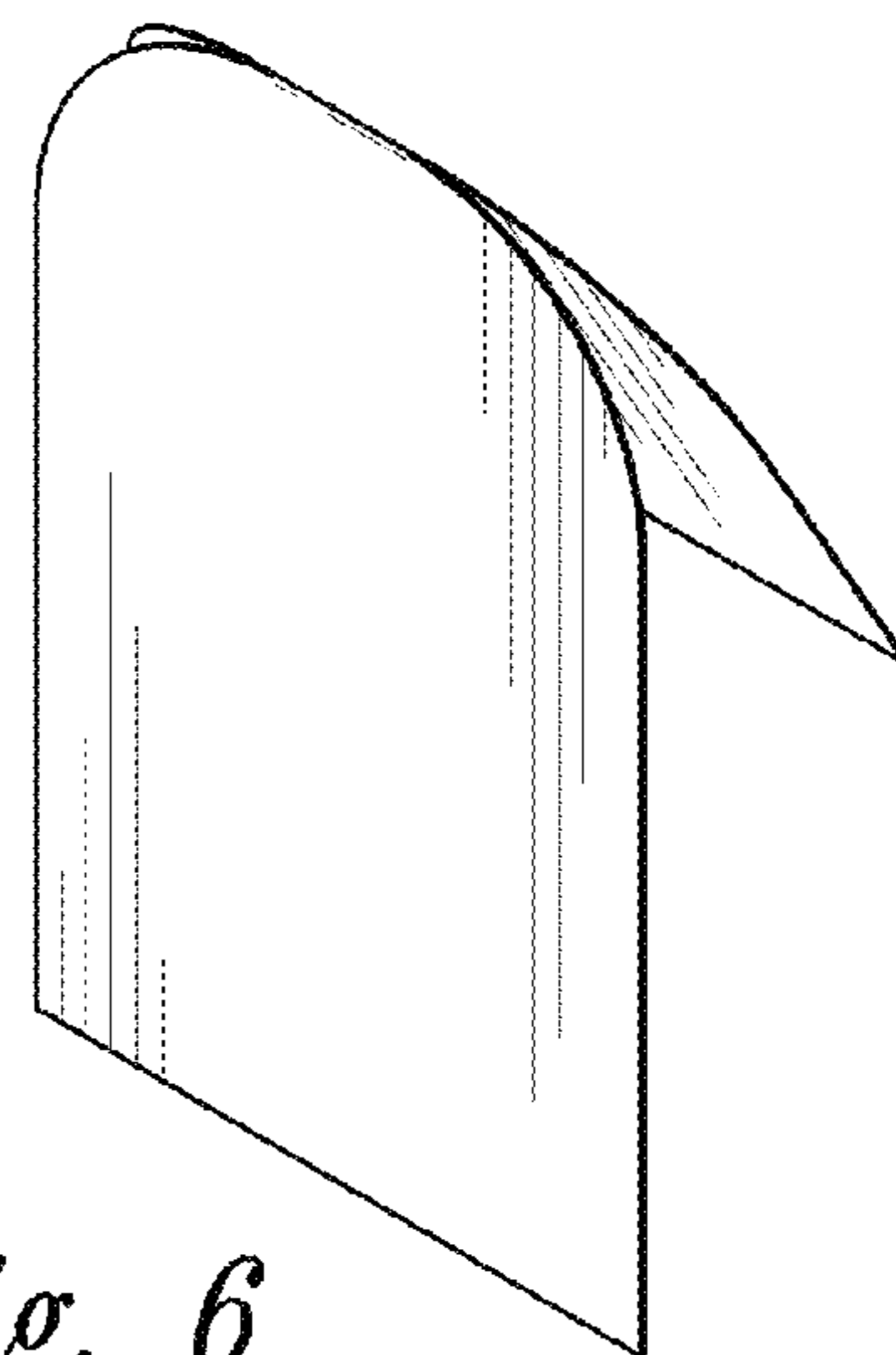
*Fig. 3*



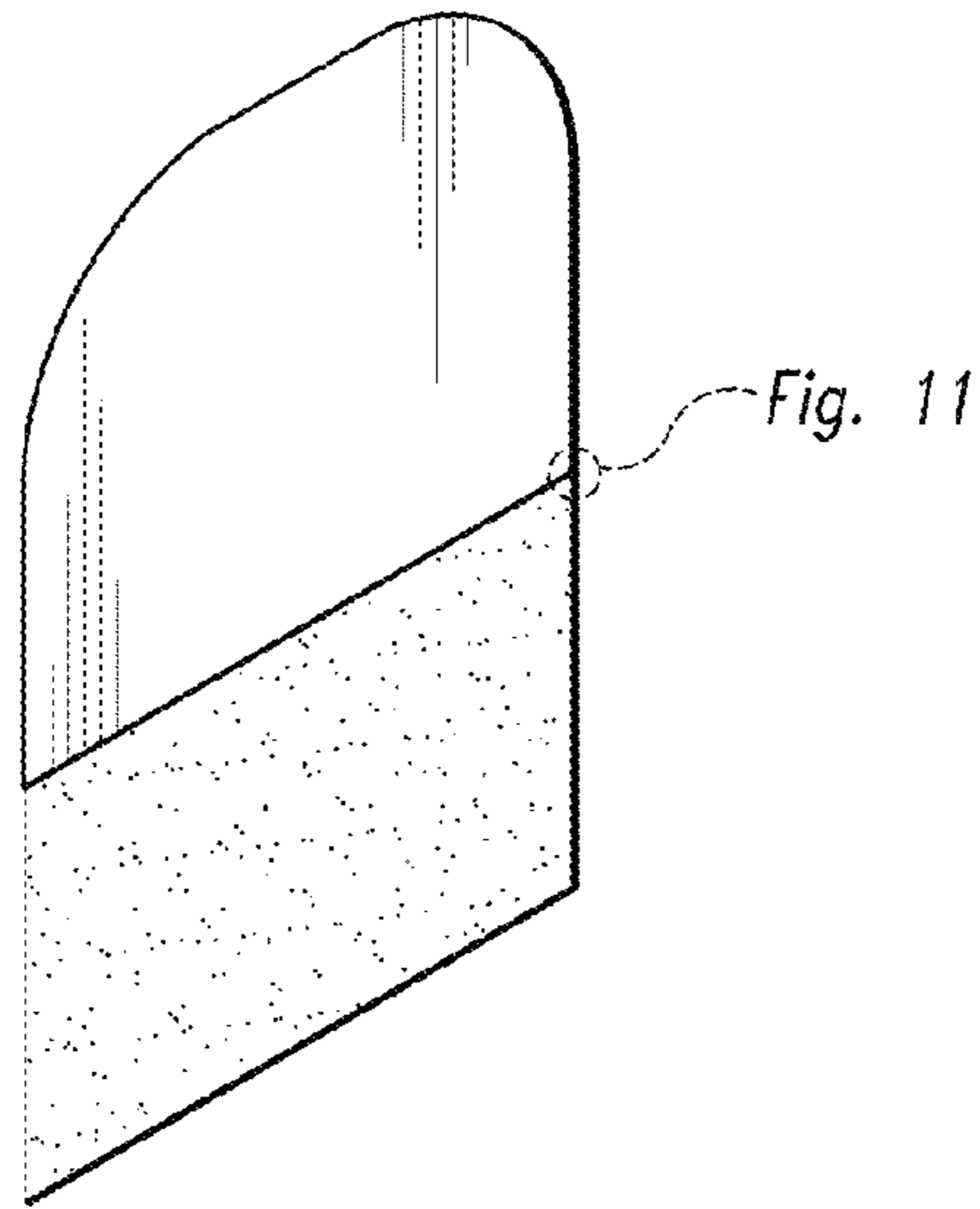
*Fig. 4*



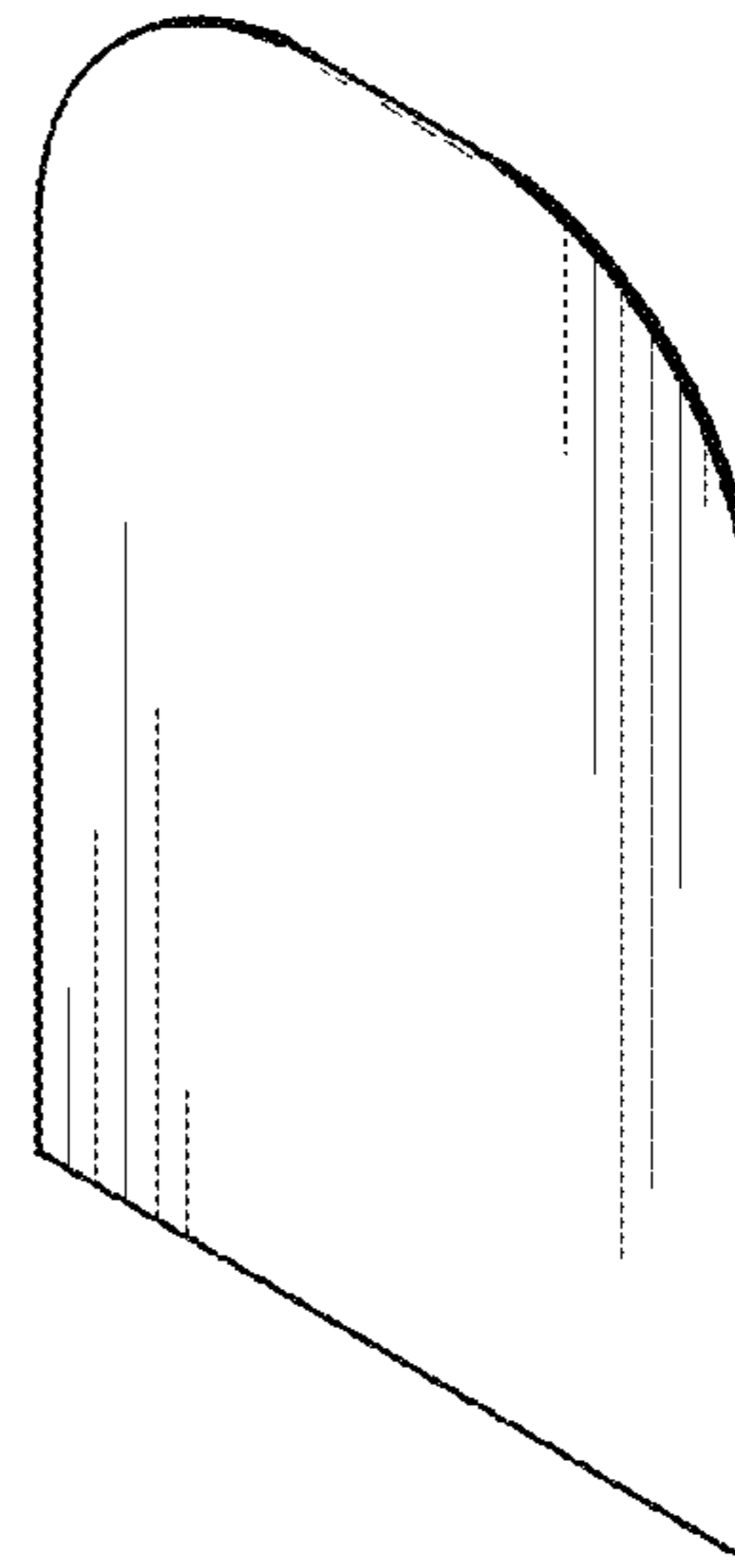
*Fig. 5*



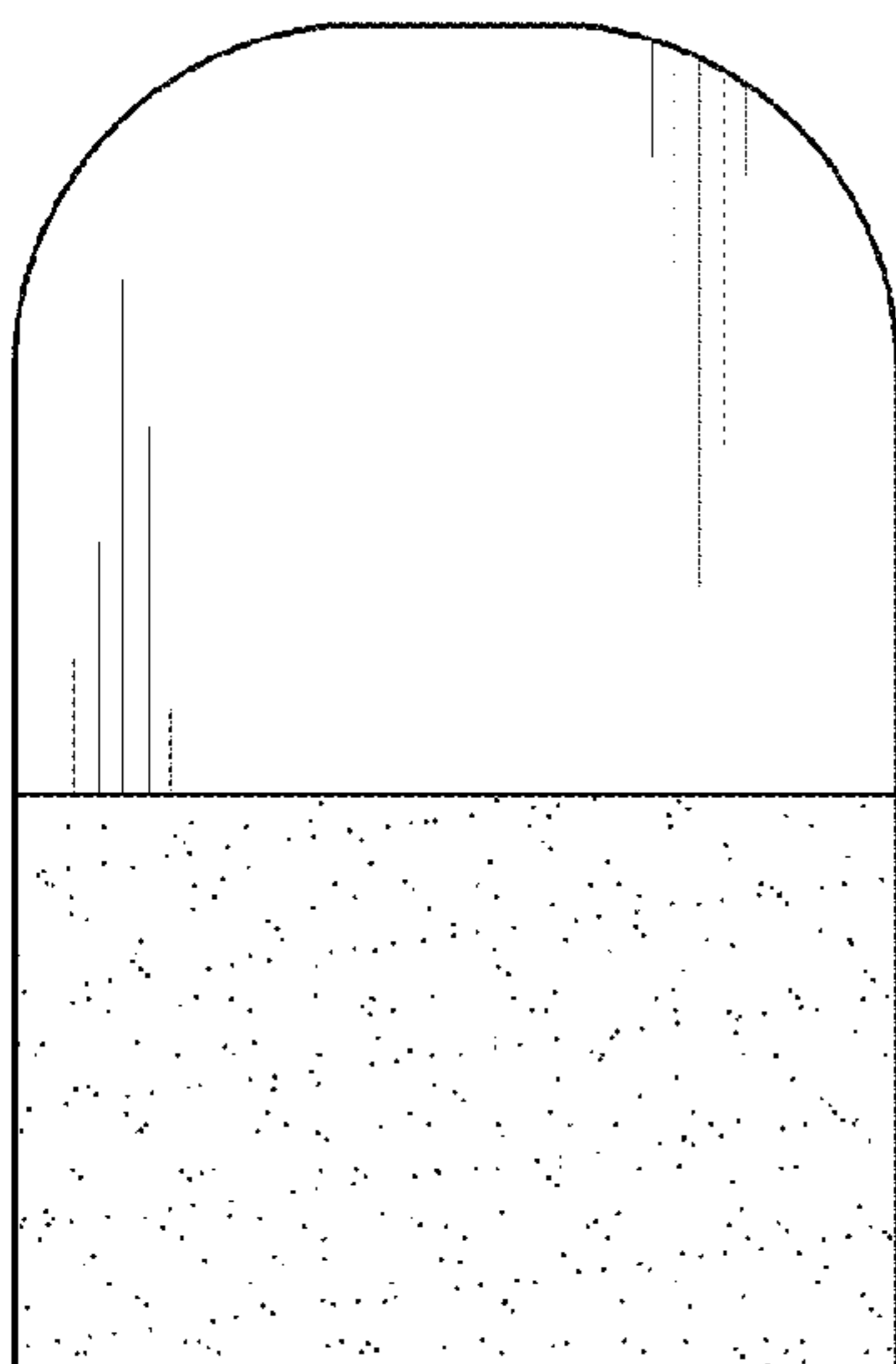
*Fig. 6*



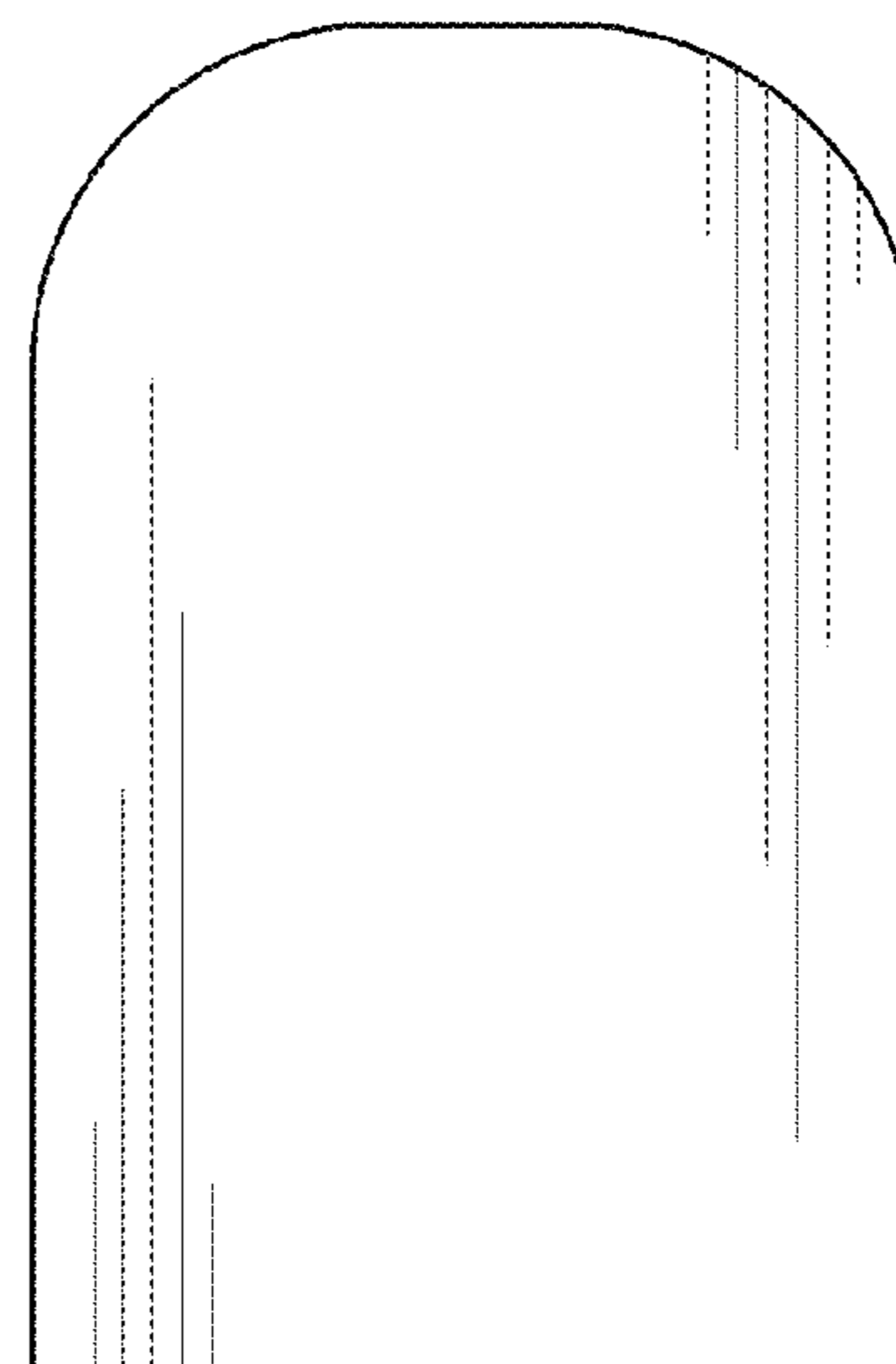
*Fig. 7*



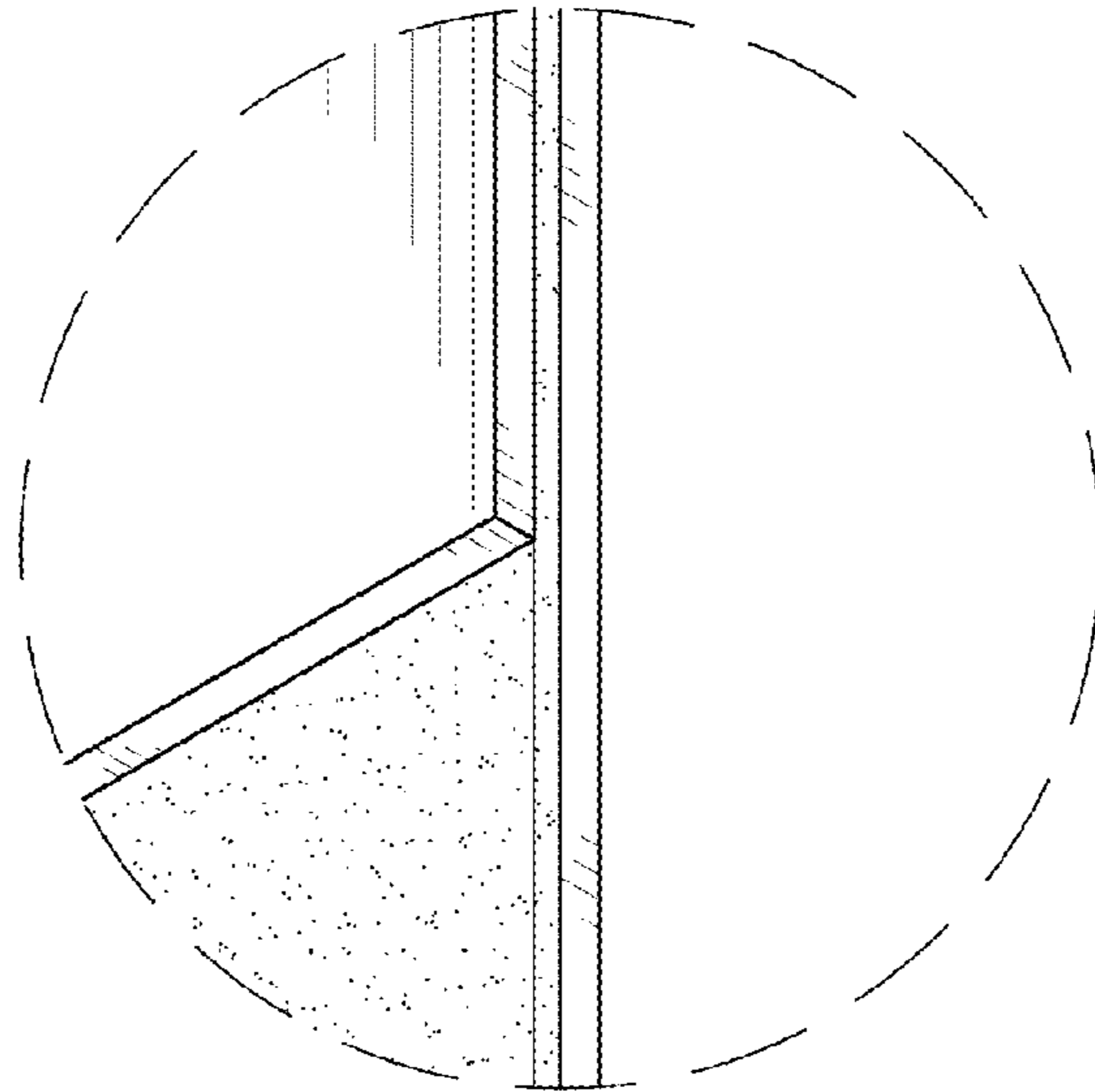
*Fig. 8*



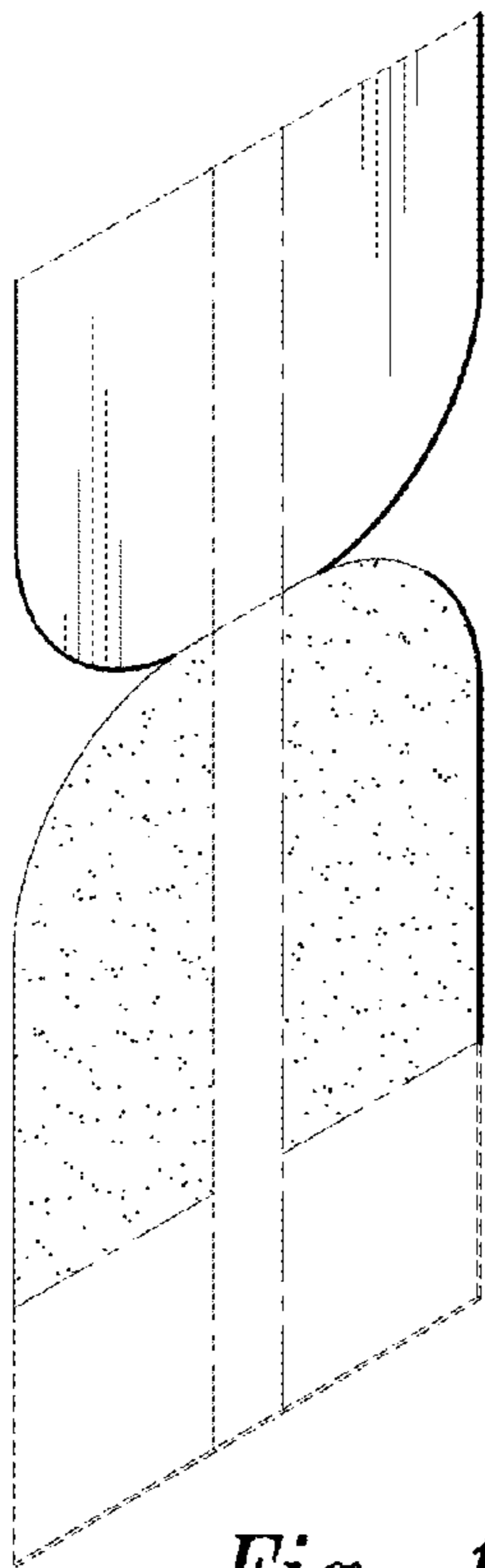
*Fig. 9*



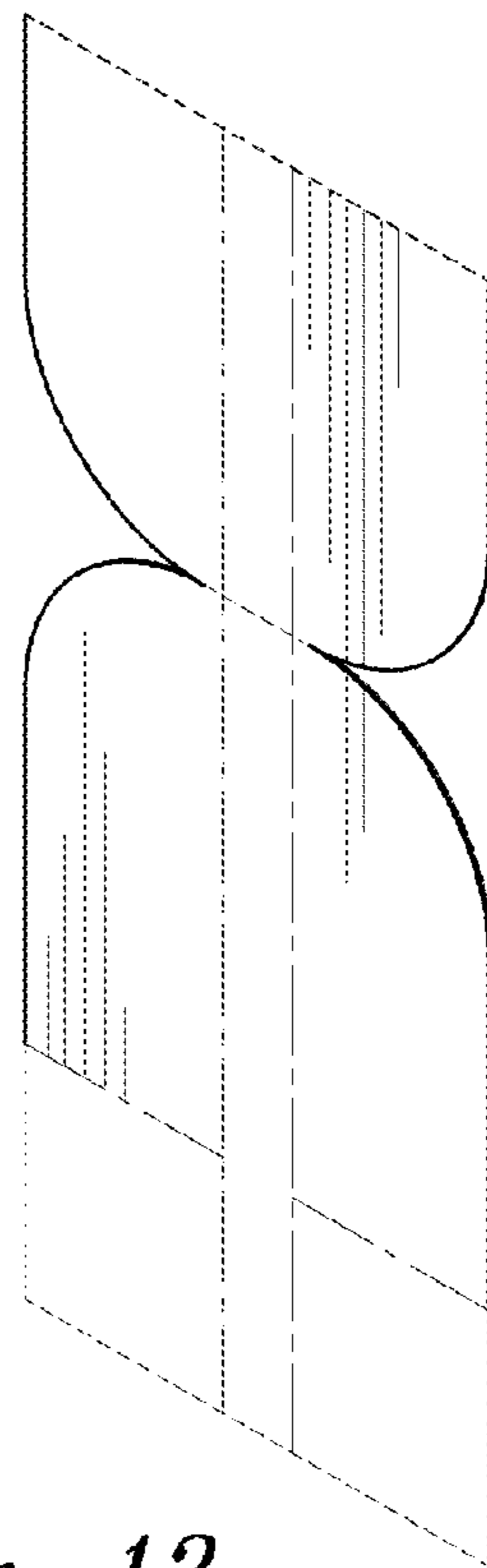
*Fig. 10*



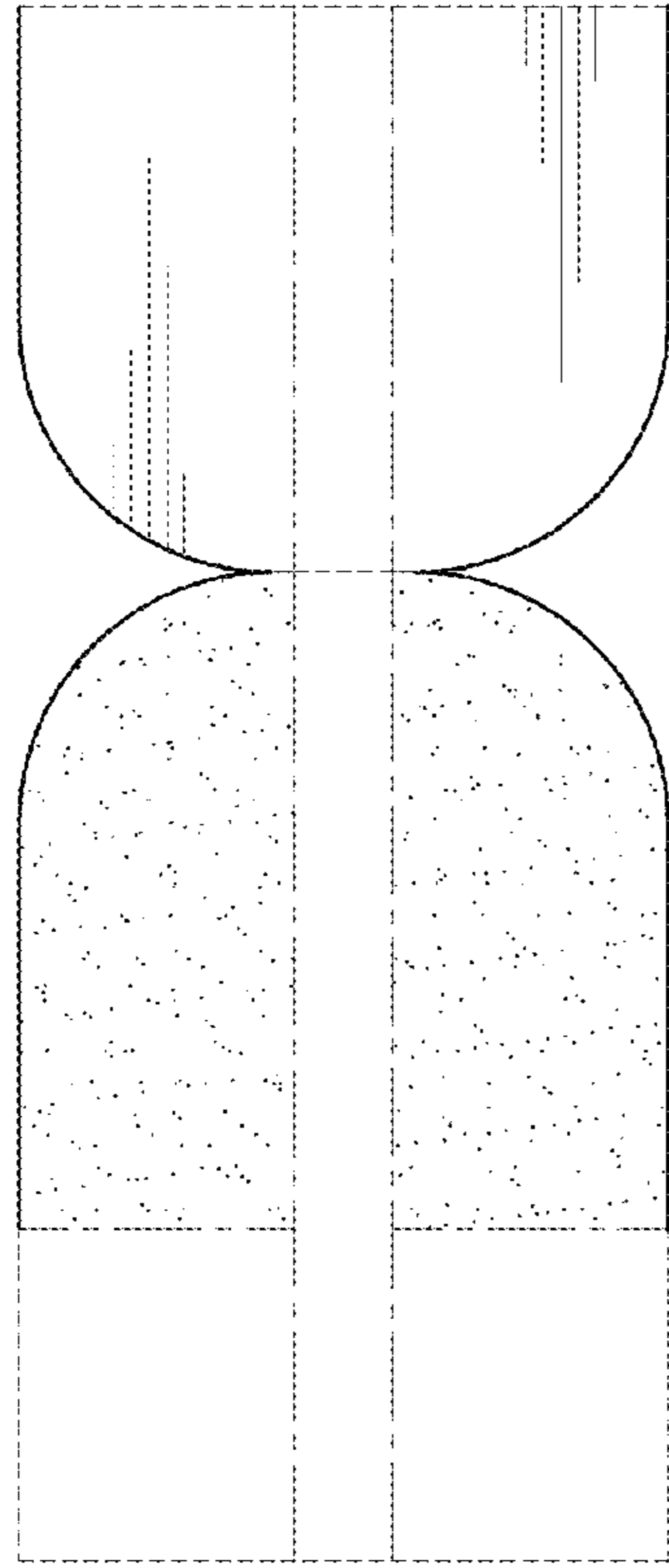
*Fig. 11*



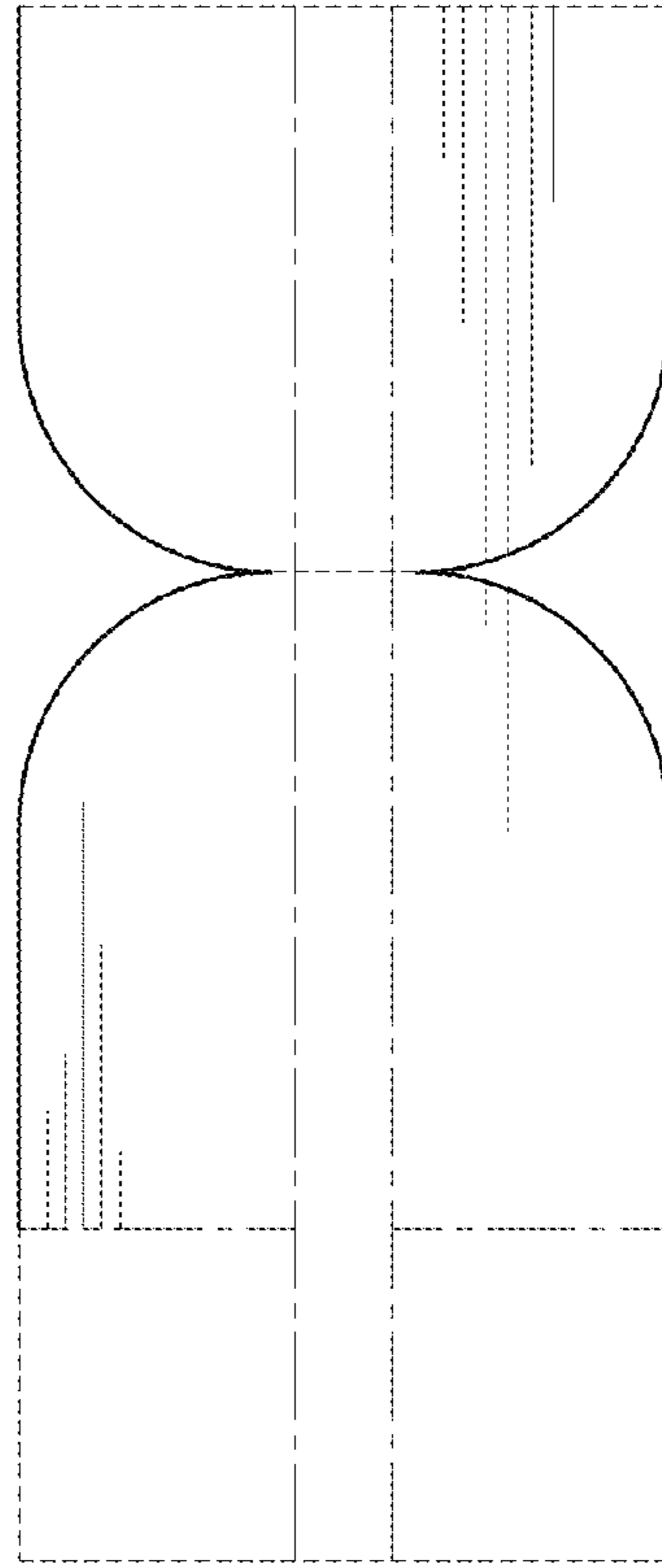
*Fig. 12*



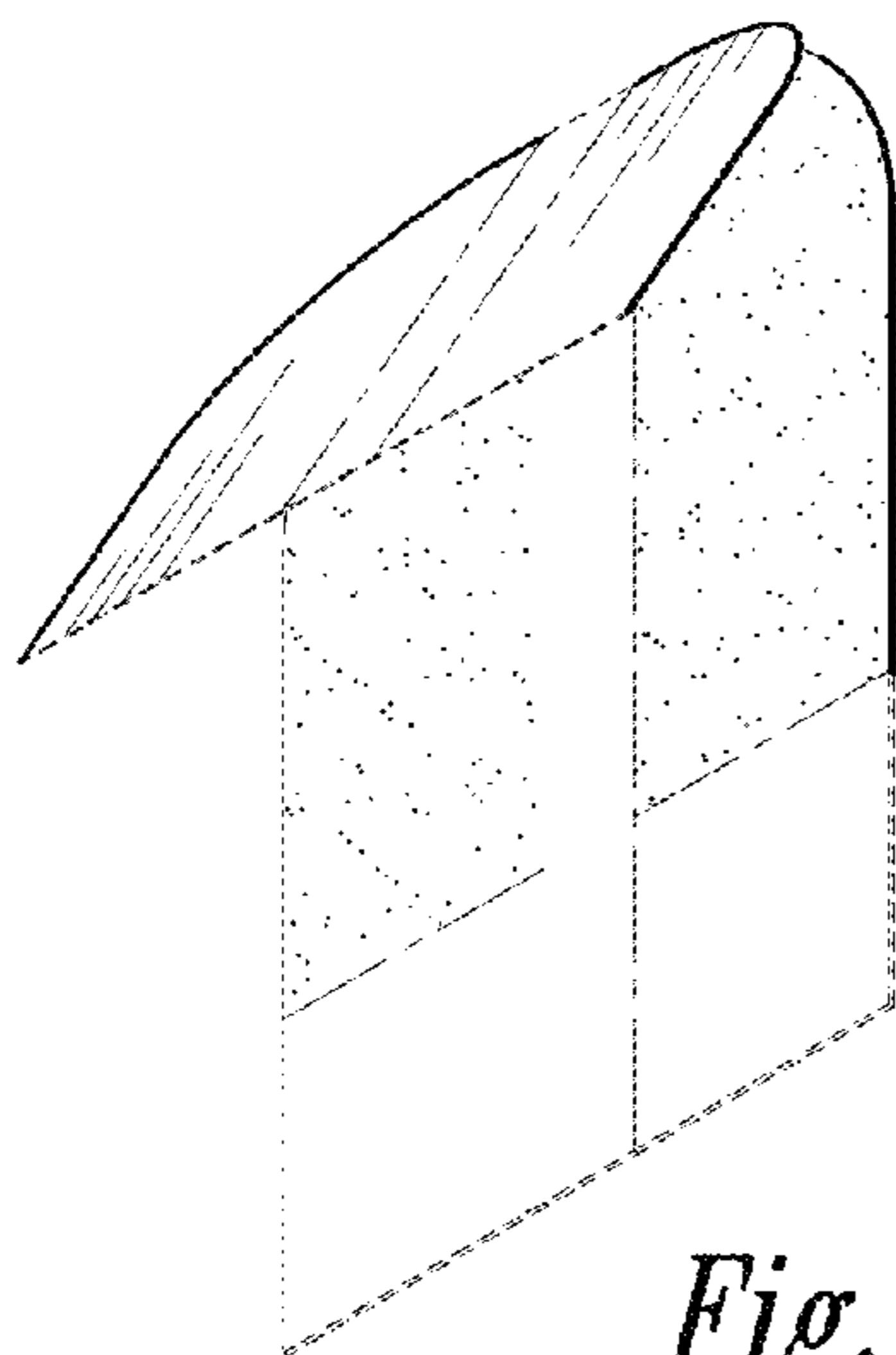
*Fig. 13*



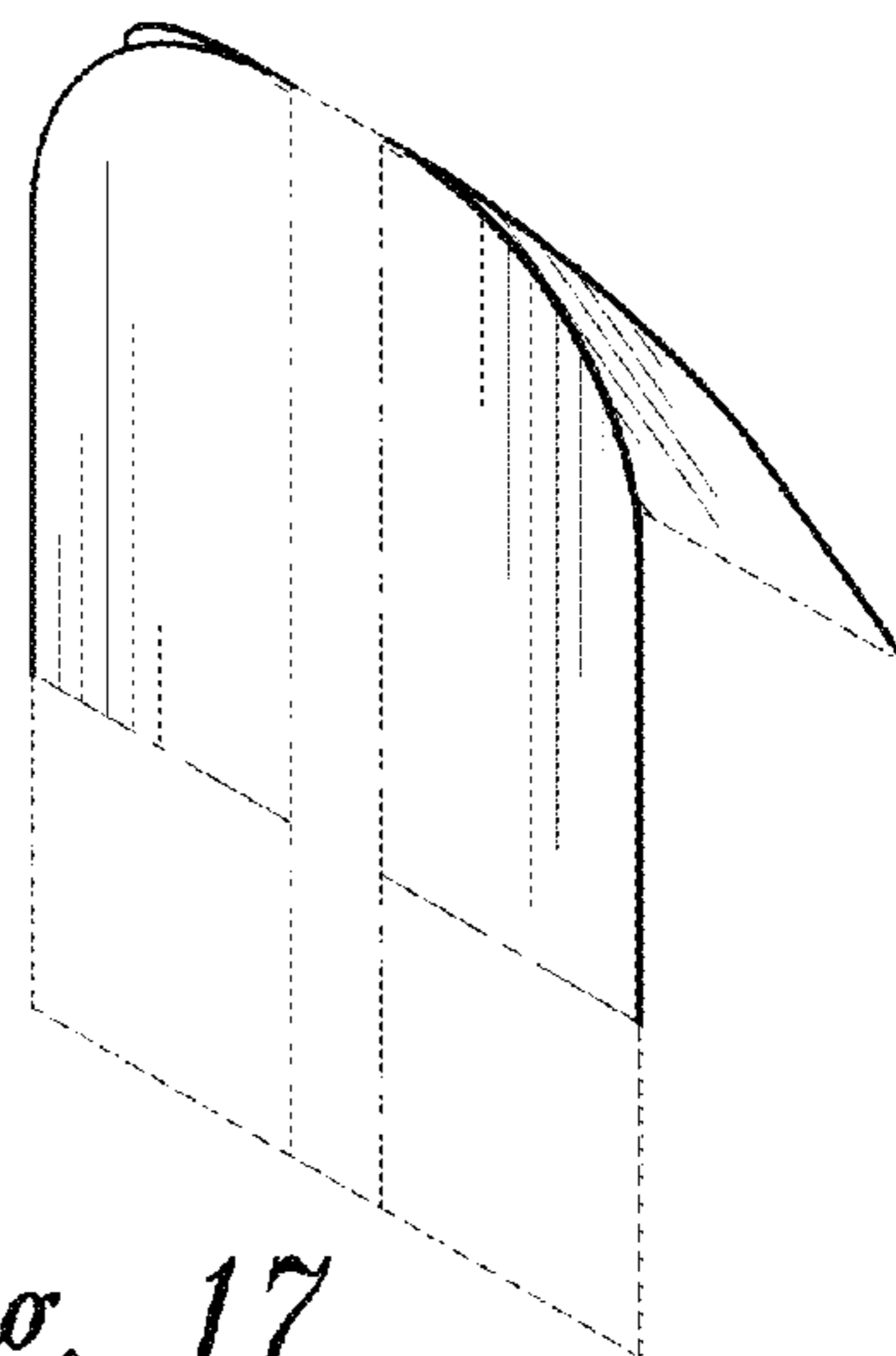
*Fig. 14*



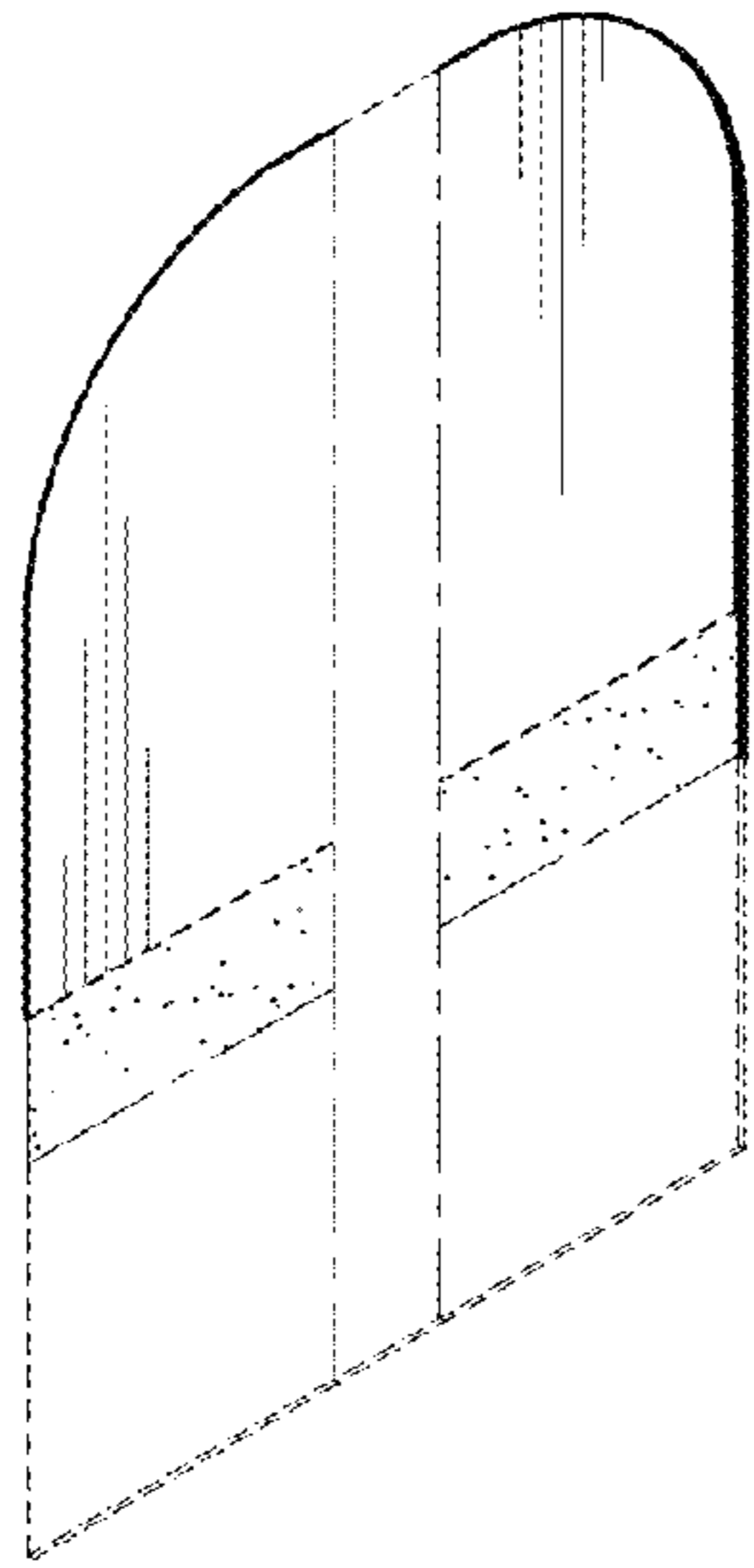
*Fig. 15*



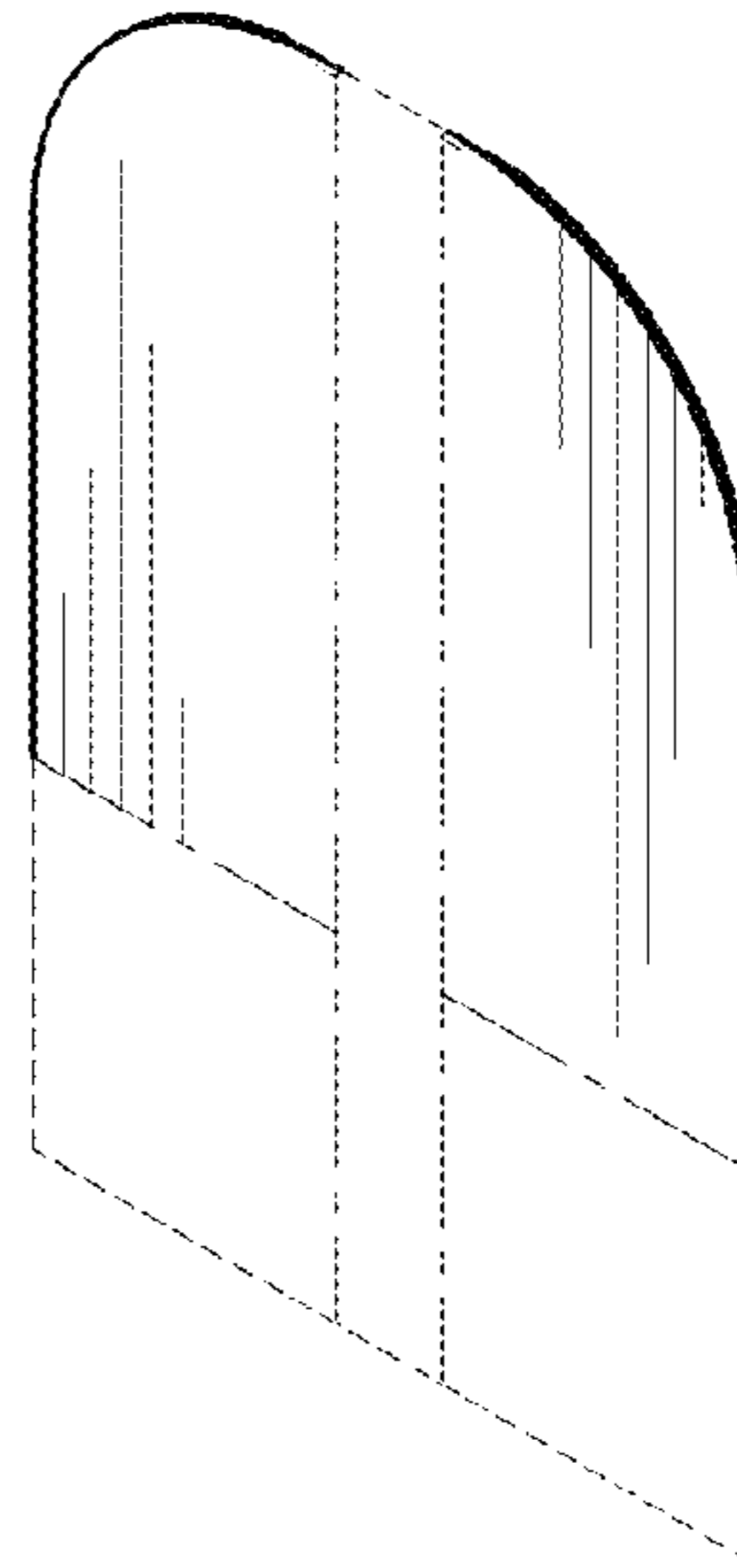
*Fig. 16*



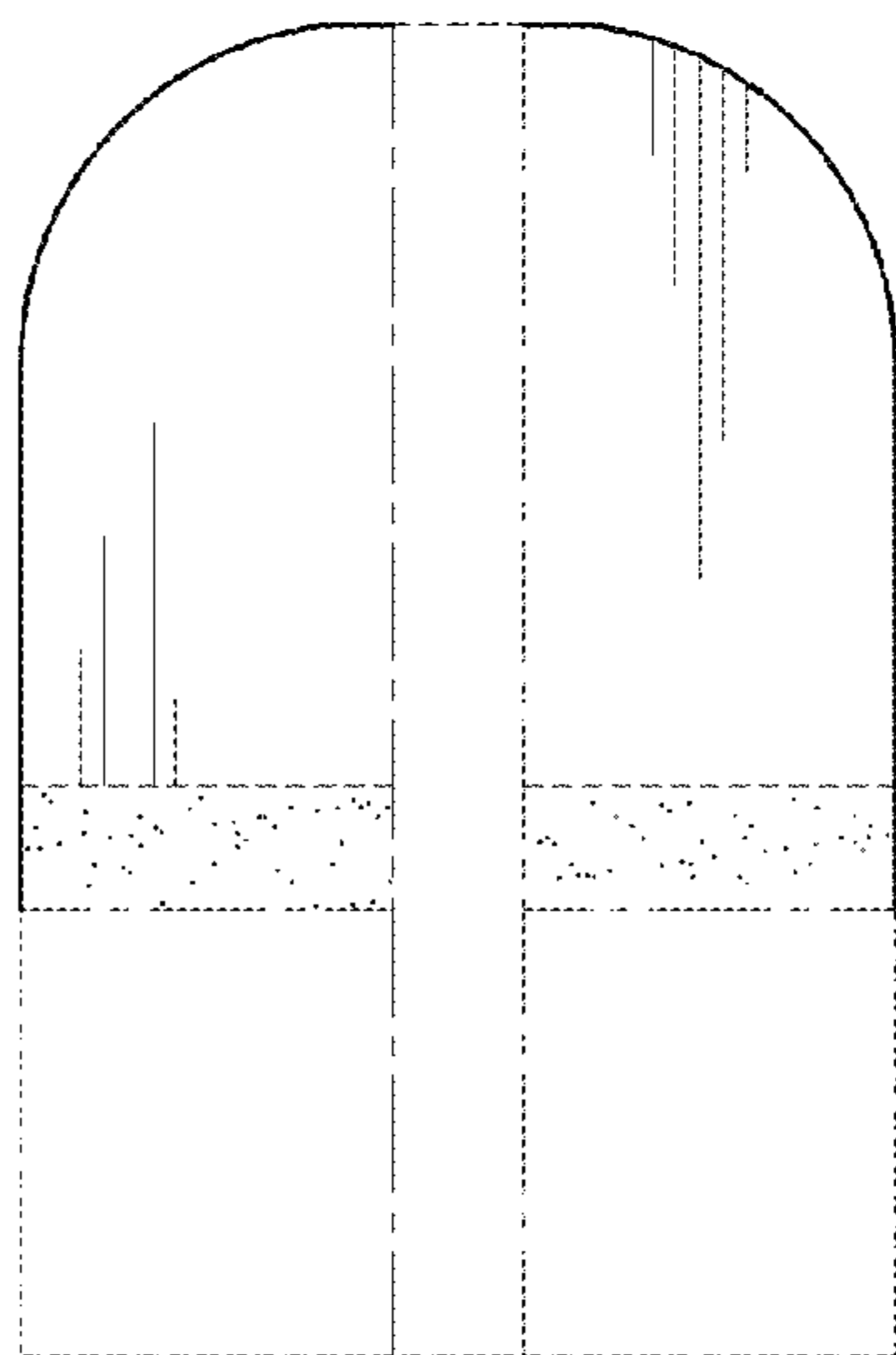
*Fig. 17*



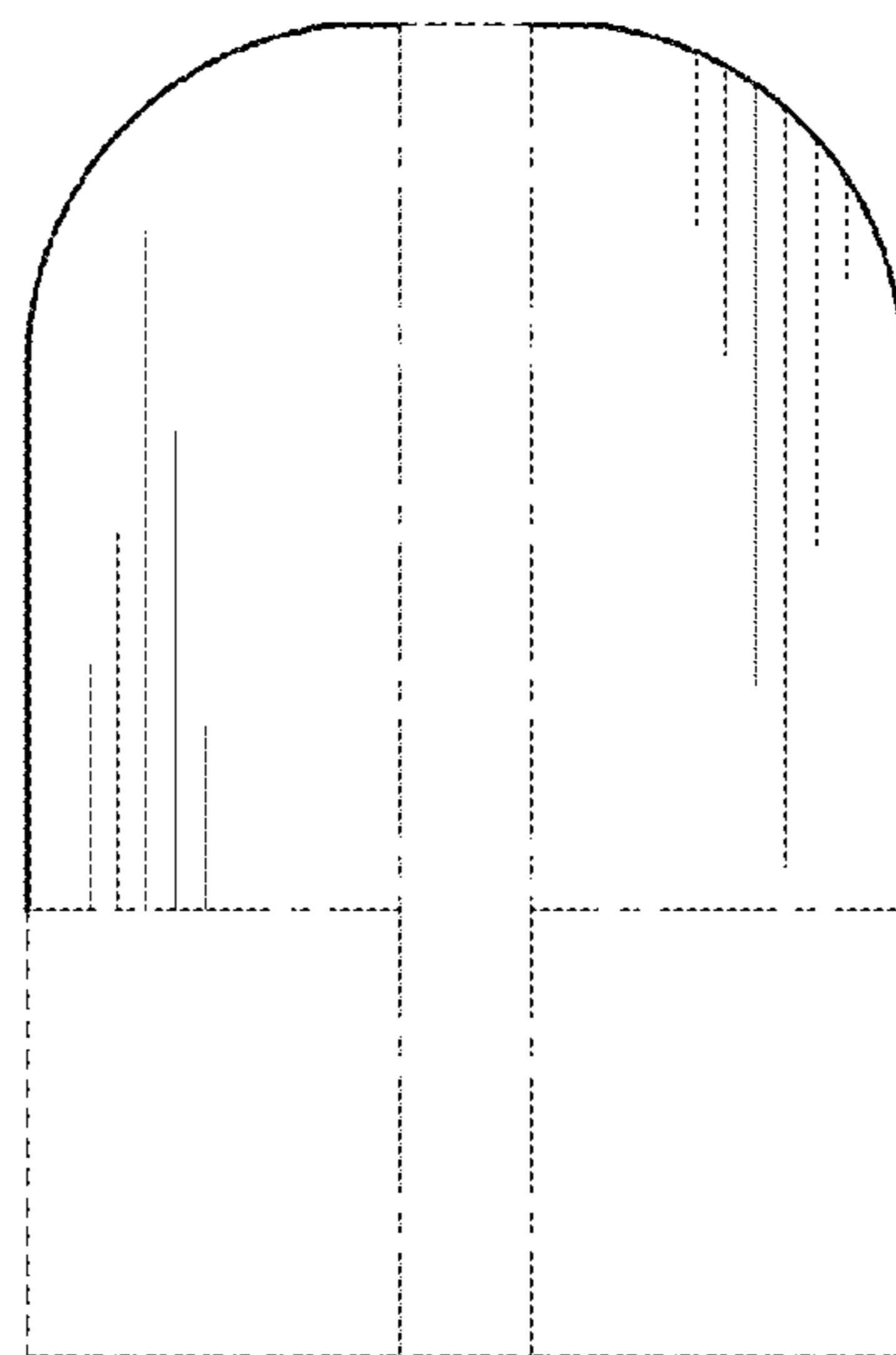
*Fig. 18*



*Fig. 19*

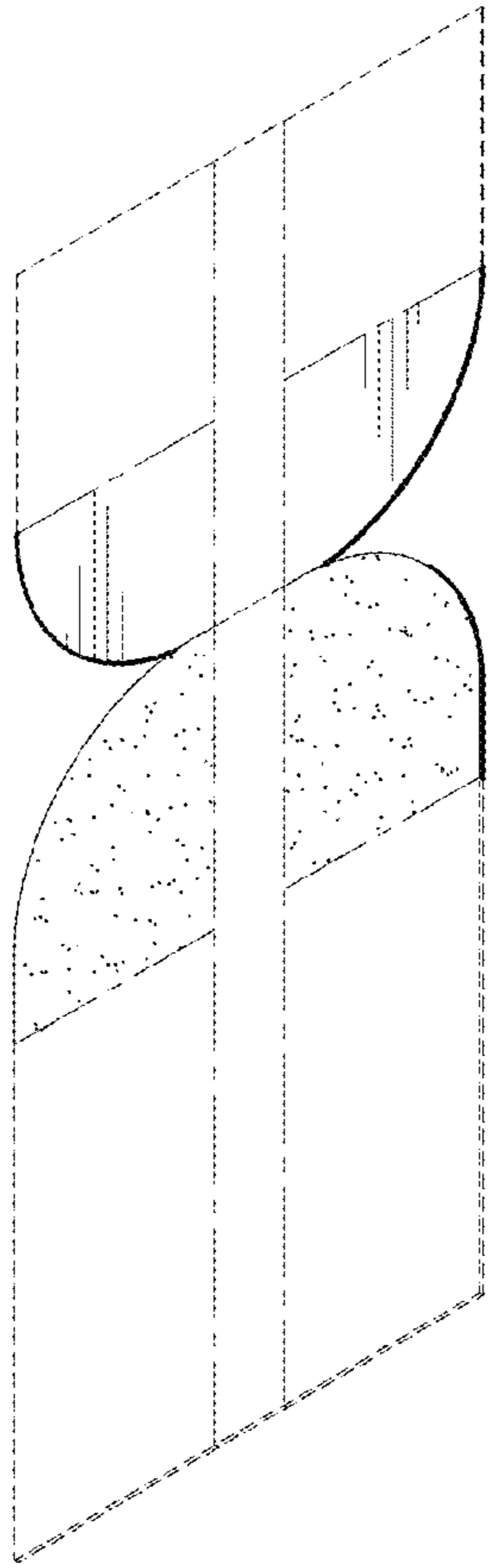


*Fig. 20*

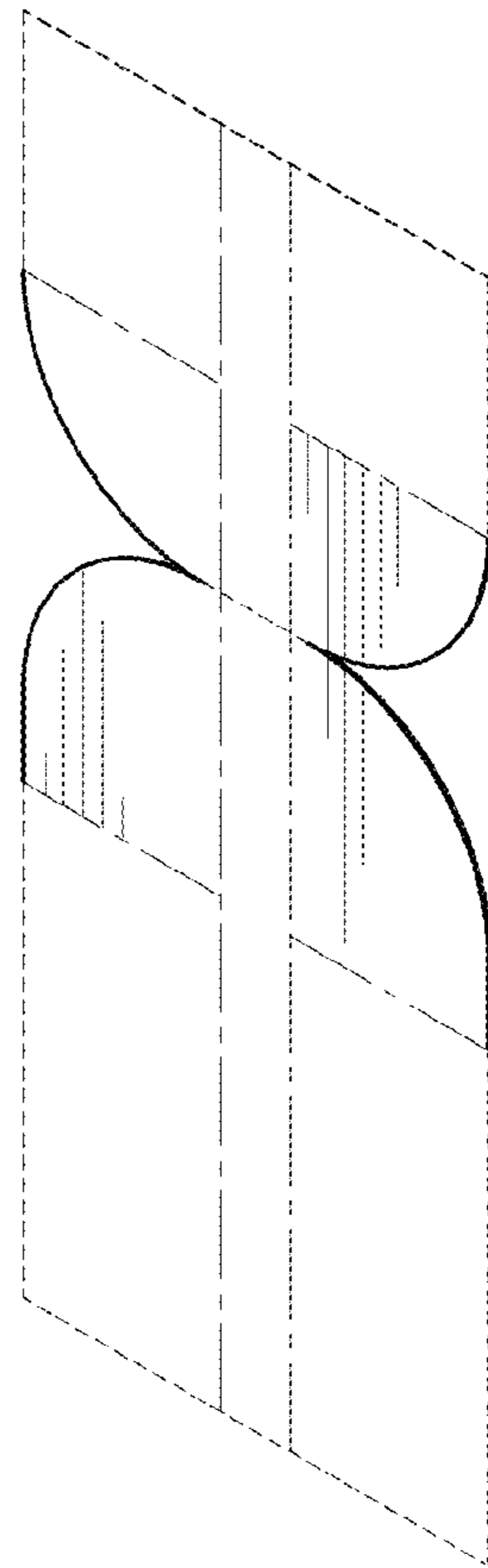


*Fig. 21*

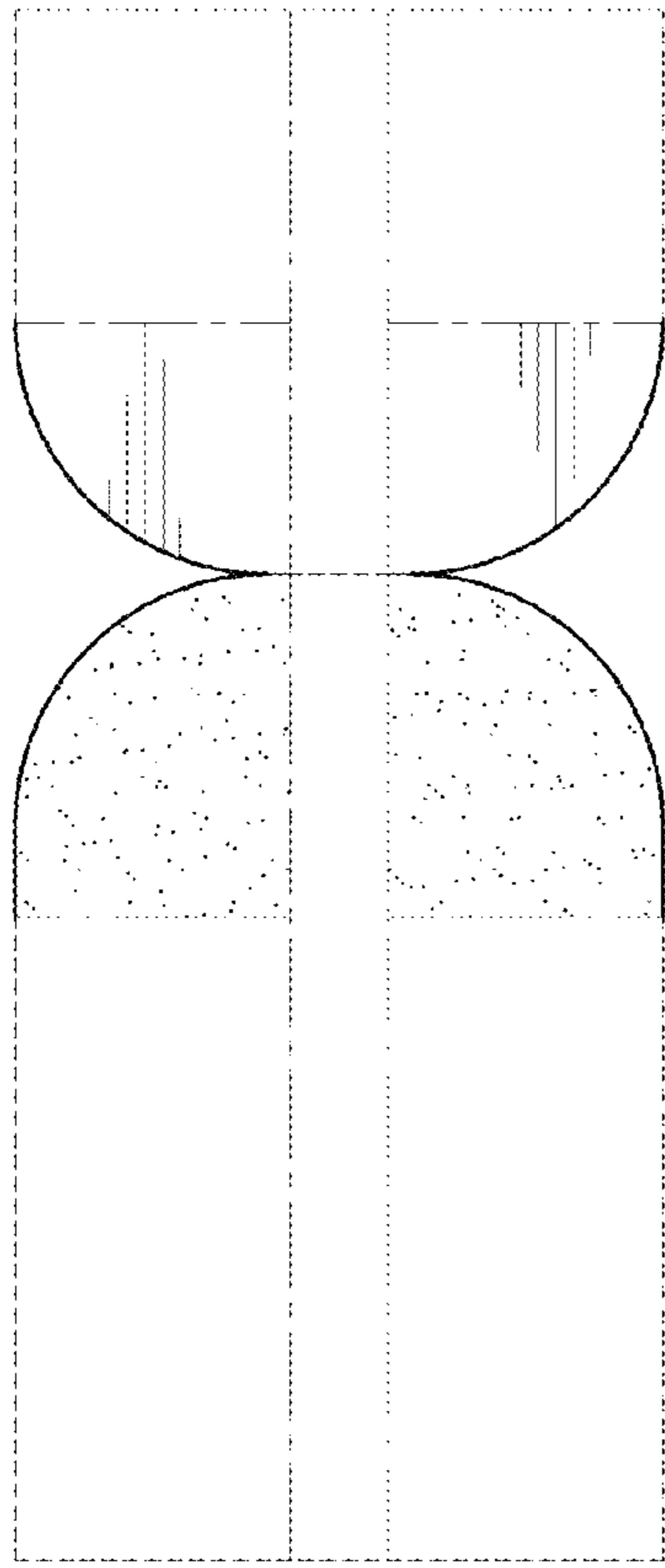




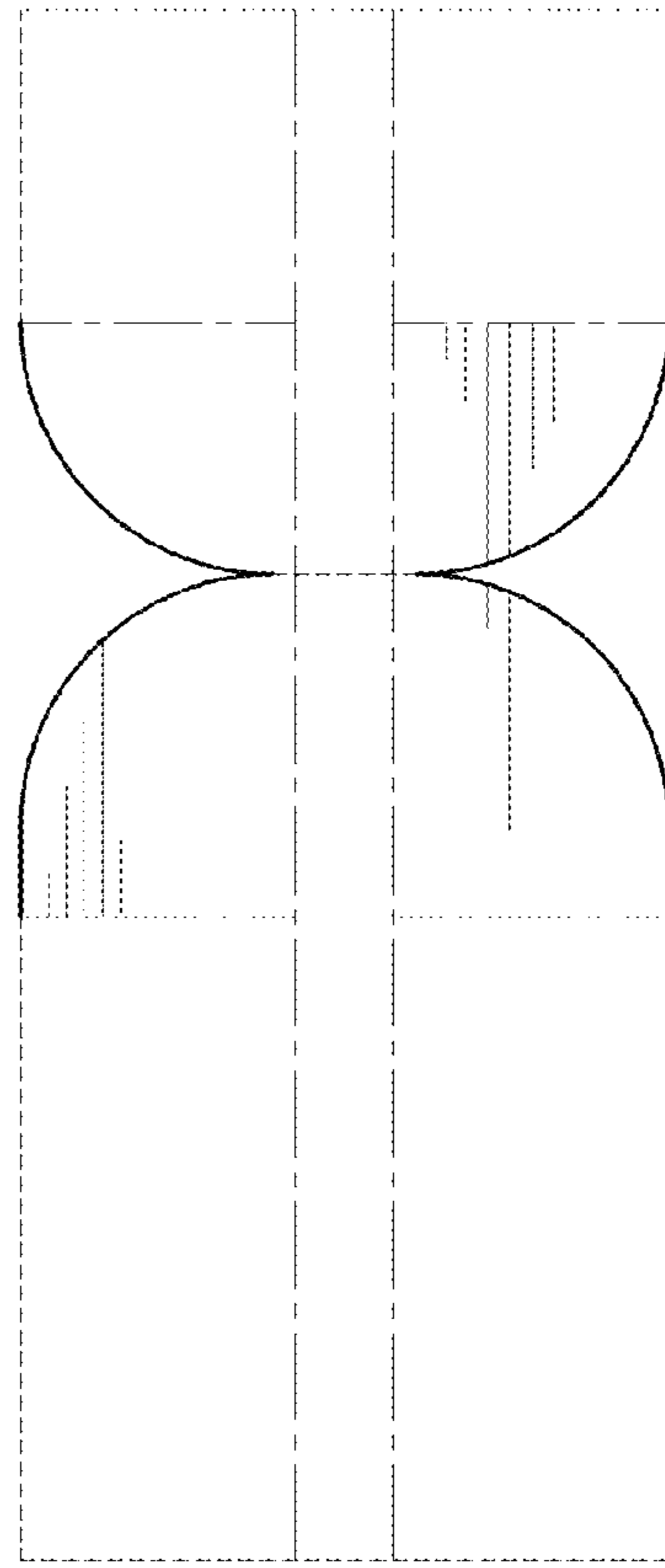
*Fig. 22*



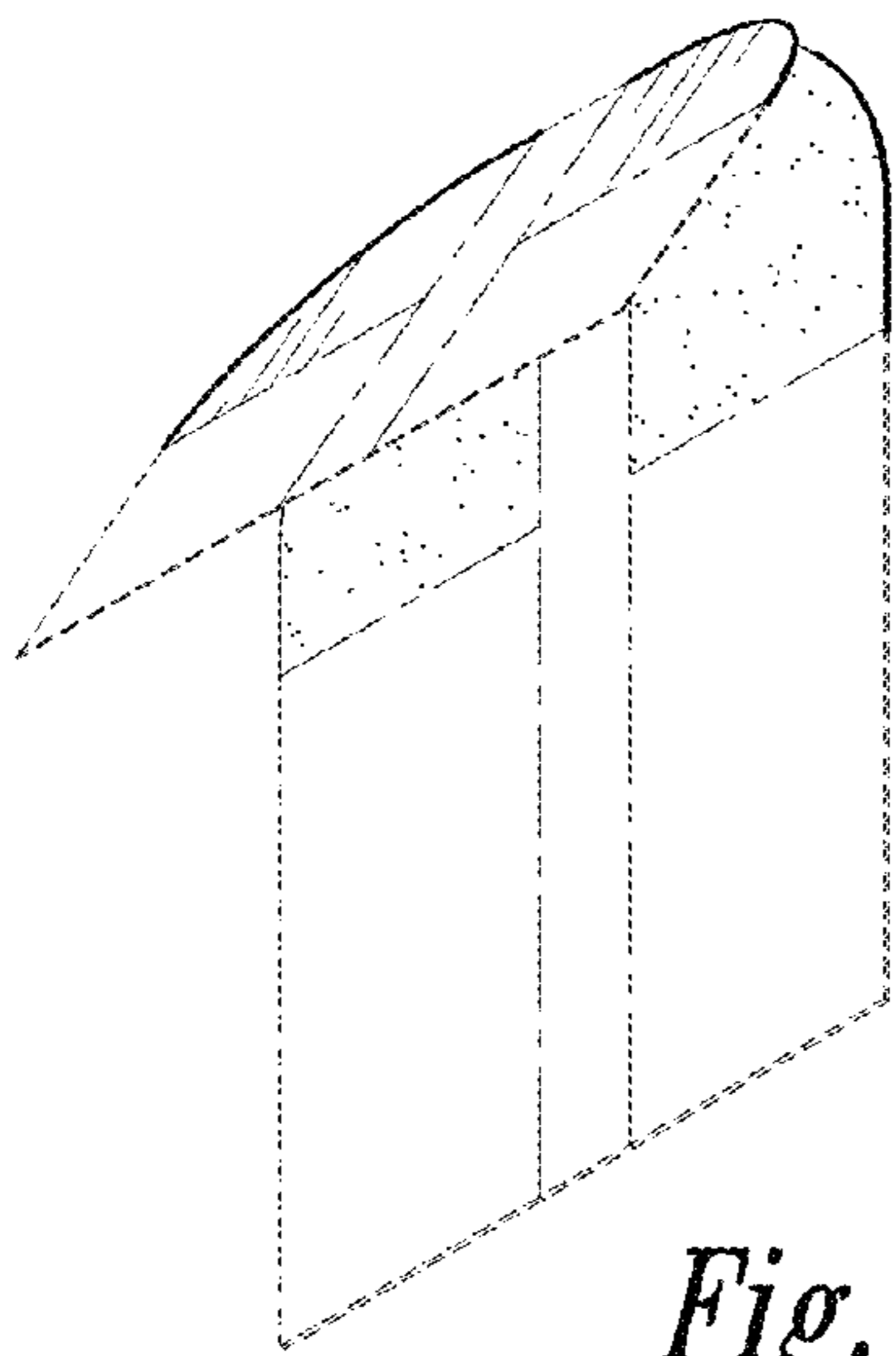
*Fig. 23*



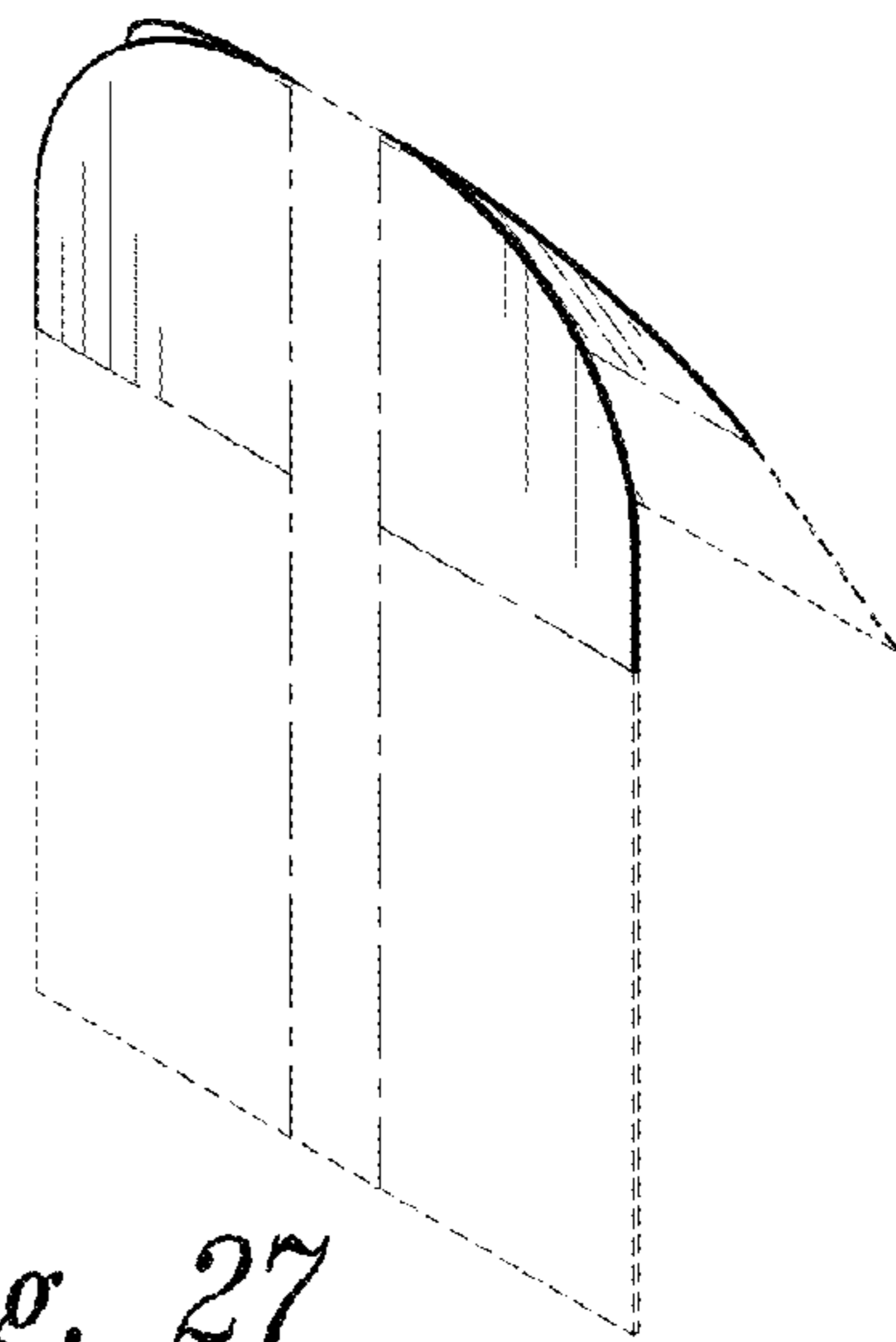
*Fig. 24*



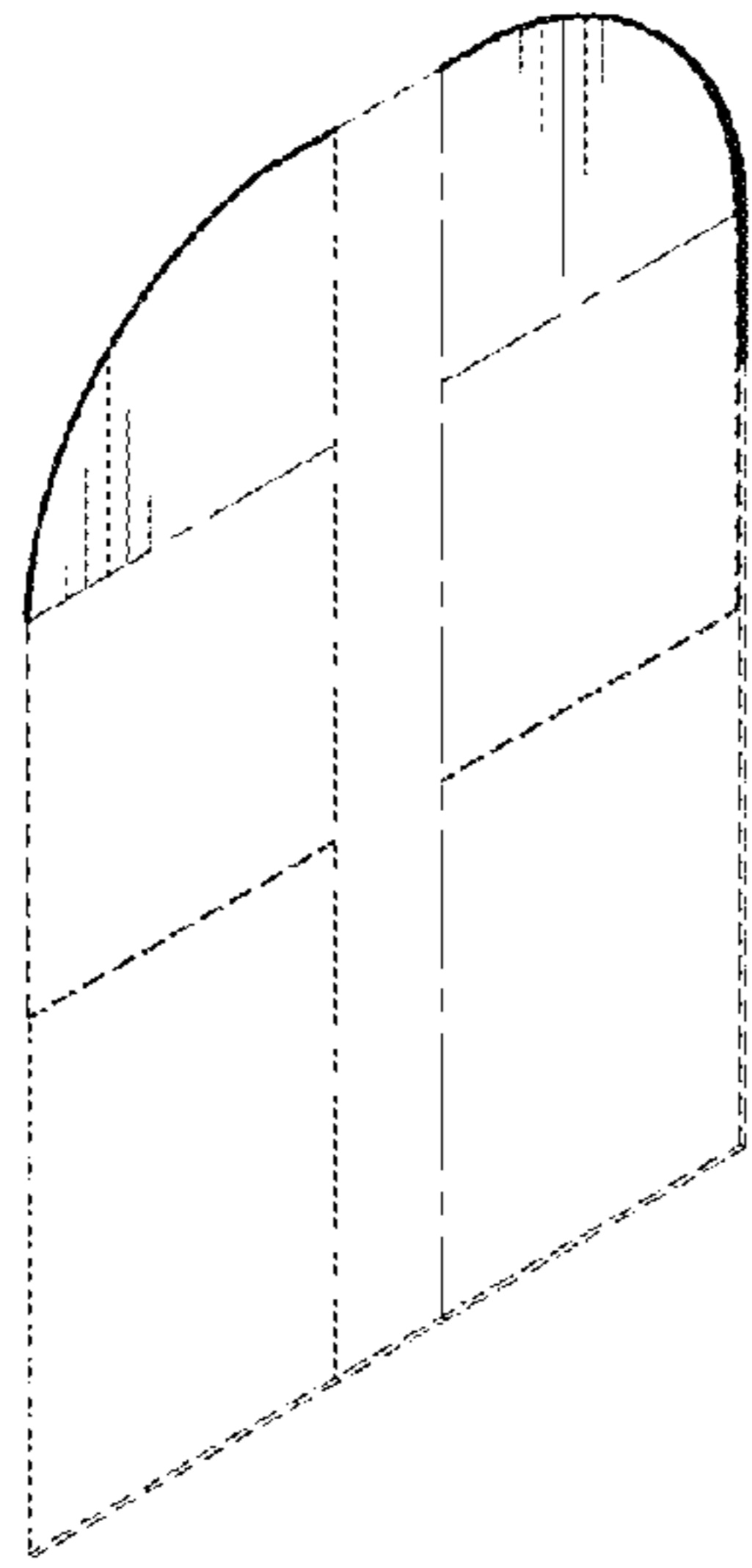
*Fig. 25*



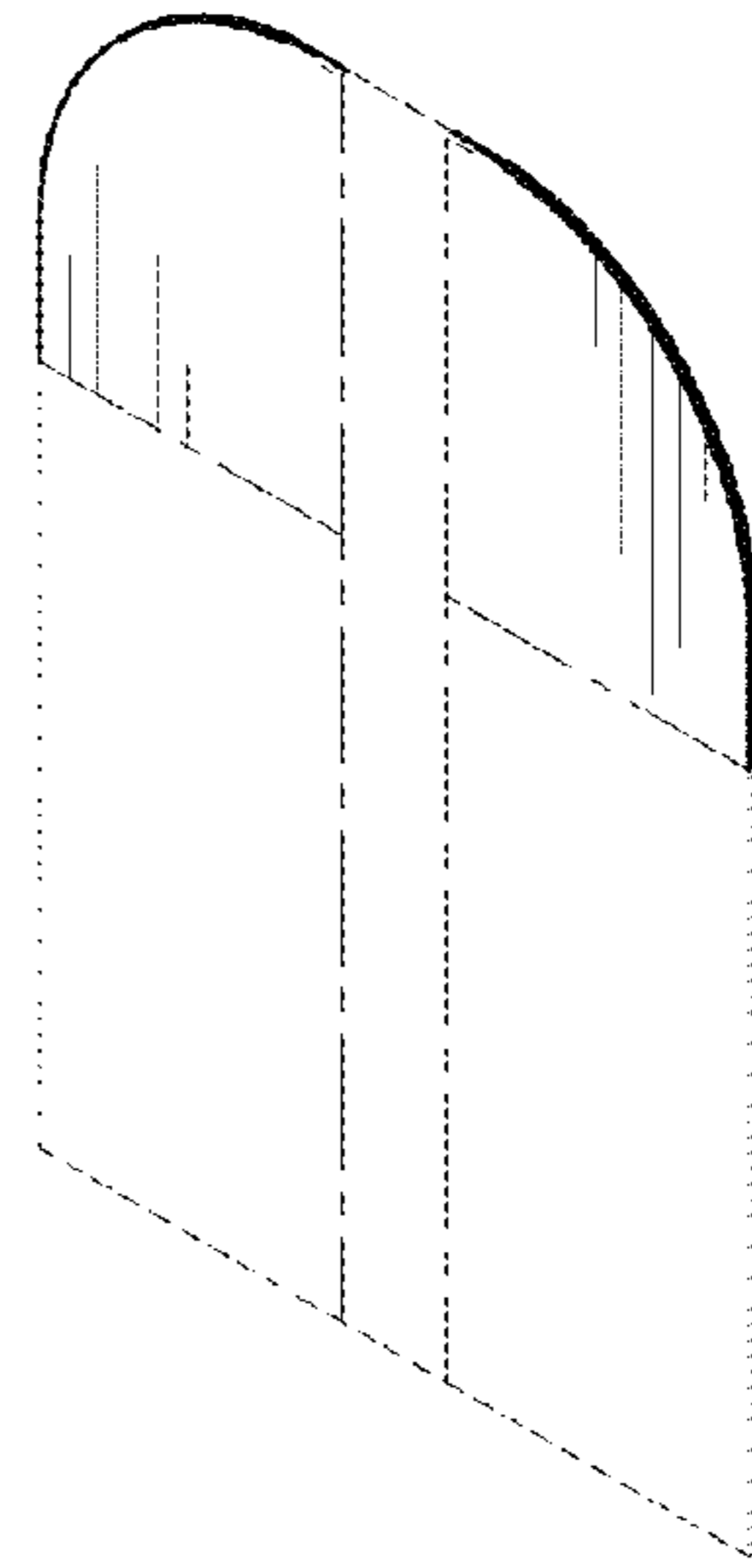
*Fig. 26*



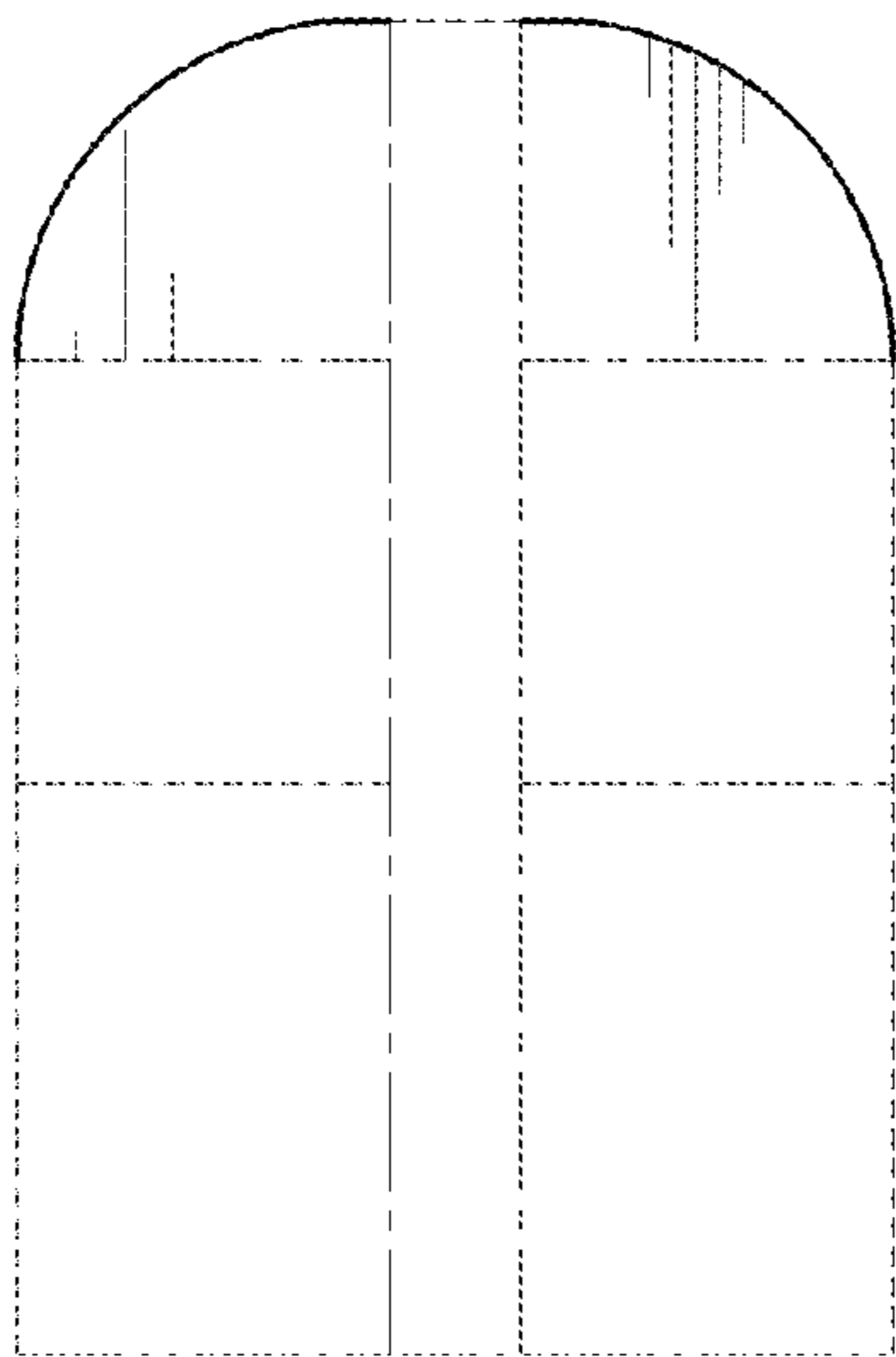
*Fig. 27*



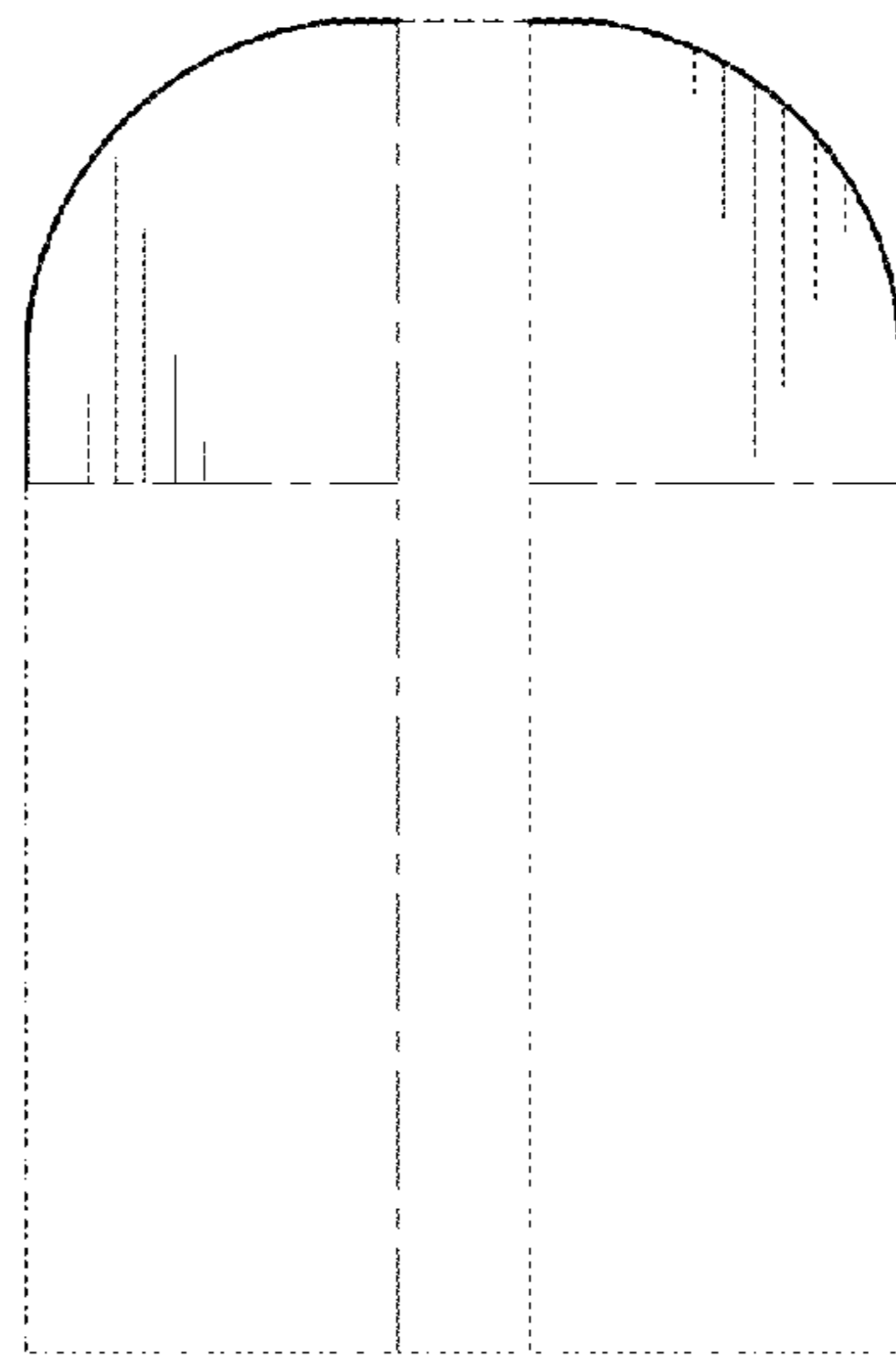
*Fig. 28*



*Fig. 29*



*Fig. 30*



*Fig. 31*