



US00D733696S

(12) **United States Design Patent**
Burgett et al.

(10) **Patent No.:** **US D733,696 S**

(45) **Date of Patent:** **** Jul. 7, 2015**

(54) **PHONE CASE**

(71) Applicant: **Harman International Industries, Incorporated**, Stamford, CT (US)

(72) Inventors: **Seth D Burgett**, Glen Carbon, IL (US); **Effrosini A. Karayiannis**, Saint Louis, MO (US); **Aaron Gorga**, Saint Louis, MO (US); **Alex Hill**, Saint Louis, MO (US); **Grace Meyer**, Hannibal, MO (US)

(73) Assignee: **Harman International Industries, Incorporated**, Northridge, CA (US)

(**) Term: **14 Years**

(21) Appl. No.: **29/465,297**

(22) Filed: **Aug. 26, 2013**

(51) **LOC (10) Cl.** **14-03**

(52) **U.S. Cl.**
USPC **D14/250**

(58) **Field of Classification Search**
USPC D14/250–253, 440, 203.3–203.7, 217, D14/496, 248, 238.1, 240, 447, 205; D3/201, 218, 269, 301, 273, 303, 208; D13/103, 107–108; 220/4.02; 248/309.1; 361/679.56; 379/426, 379/433.11, 455; 455/575.1, 575.8; 190/100; 206/305, 320; D8/356

See application file for complete search history.

(56) **References Cited**

U.S. PATENT DOCUMENTS

D453,880 S * 2/2002 Cheynet D5/47
D671,932 S * 12/2012 Azoulay D14/250
D682,816 S * 5/2013 Fathollahi D14/250
D685,358 S * 7/2013 Armstrong et al. D14/250

D689,479 S * 9/2013 Soffer D14/253
D696,234 S * 12/2013 Wright D14/250
D705,767 S * 5/2014 Yoon D14/250
D706,253 S * 6/2014 Simmer D14/250
D715,785 S * 10/2014 Jacob et al. D14/250
D718,756 S * 12/2014 Barfoot et al. D14/250
D721,686 S * 1/2015 Jacob et al. D14/250
2014/0233751 A1 * 8/2014 Cataldo et al. 381/74

* cited by examiner

Primary Examiner — Carla Jobe Wright

Assistant Examiner — Holly E Thurman

(74) *Attorney, Agent, or Firm* — Plumsea Law Group, LLC

(57) **CLAIM**

The ornamental design for a phone case, as shown and described.

DESCRIPTION

FIG. 1 is a front, left side, and top perspective view of the phone case in accordance with the design;
FIG. 2 is a left side elevation view thereof;
FIG. 3 is a right side elevation view thereof;
FIG. 4 is a front, left side, and bottom perspective view thereof;
FIG. 5 is a bottom plan view thereof;
FIG. 6 is a top plan view thereof;
FIG. 7 is a front elevation view thereof;
FIG. 8 is a front, right side, and top perspective view thereof;
FIG. 9 is a front, right side, and bottom perspective view thereof;
FIG. 10 is a rear, right side, and bottom perspective view thereof;
FIG. 11 is a rear, right side, and top perspective view thereof;
FIG. 12 is a rear elevation view thereof;
FIG. 13 is a left, rear, and top perspective view thereof; and
FIG. 14 is a left, rear, and bottom perspective view thereof.

1 Claim, 14 Drawing Sheets

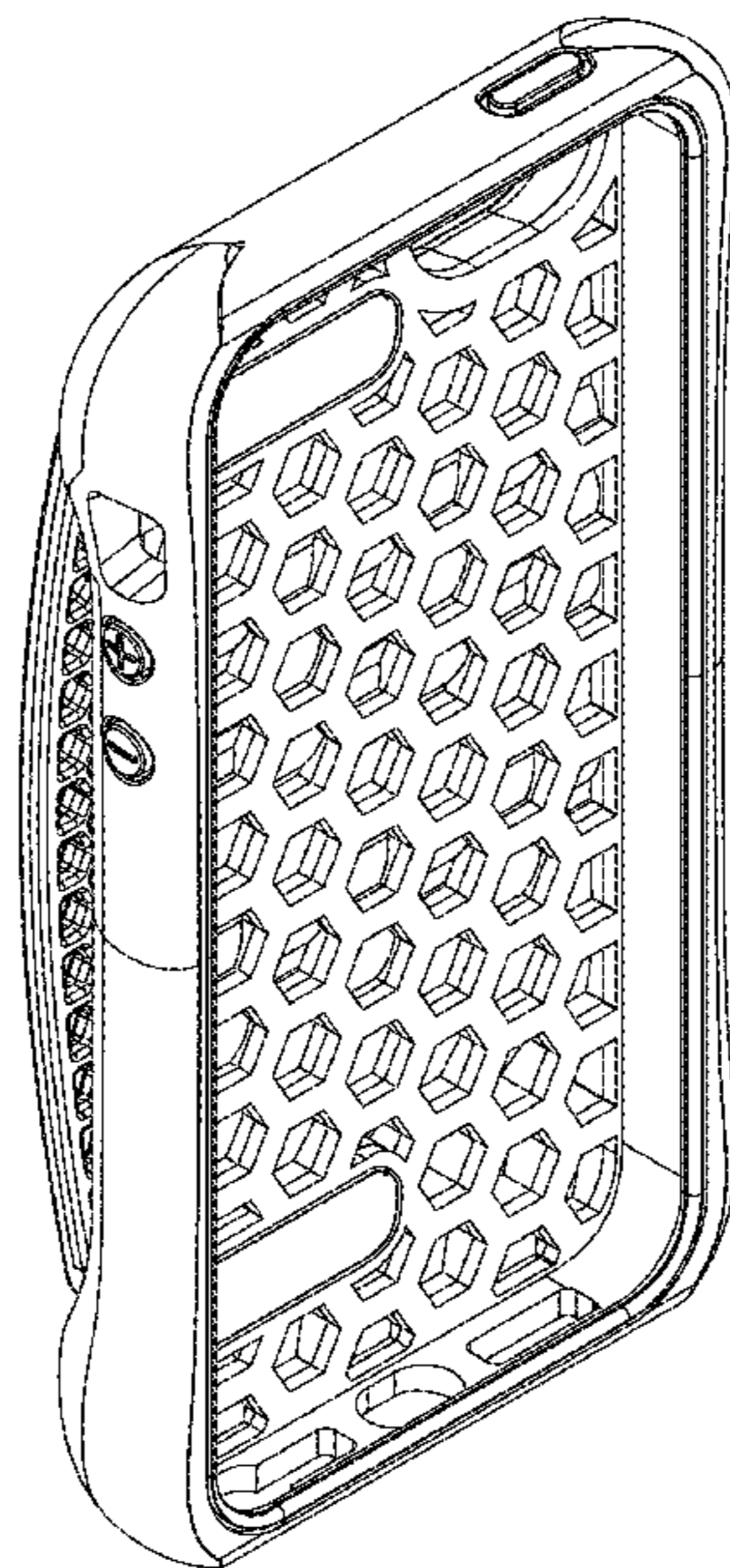

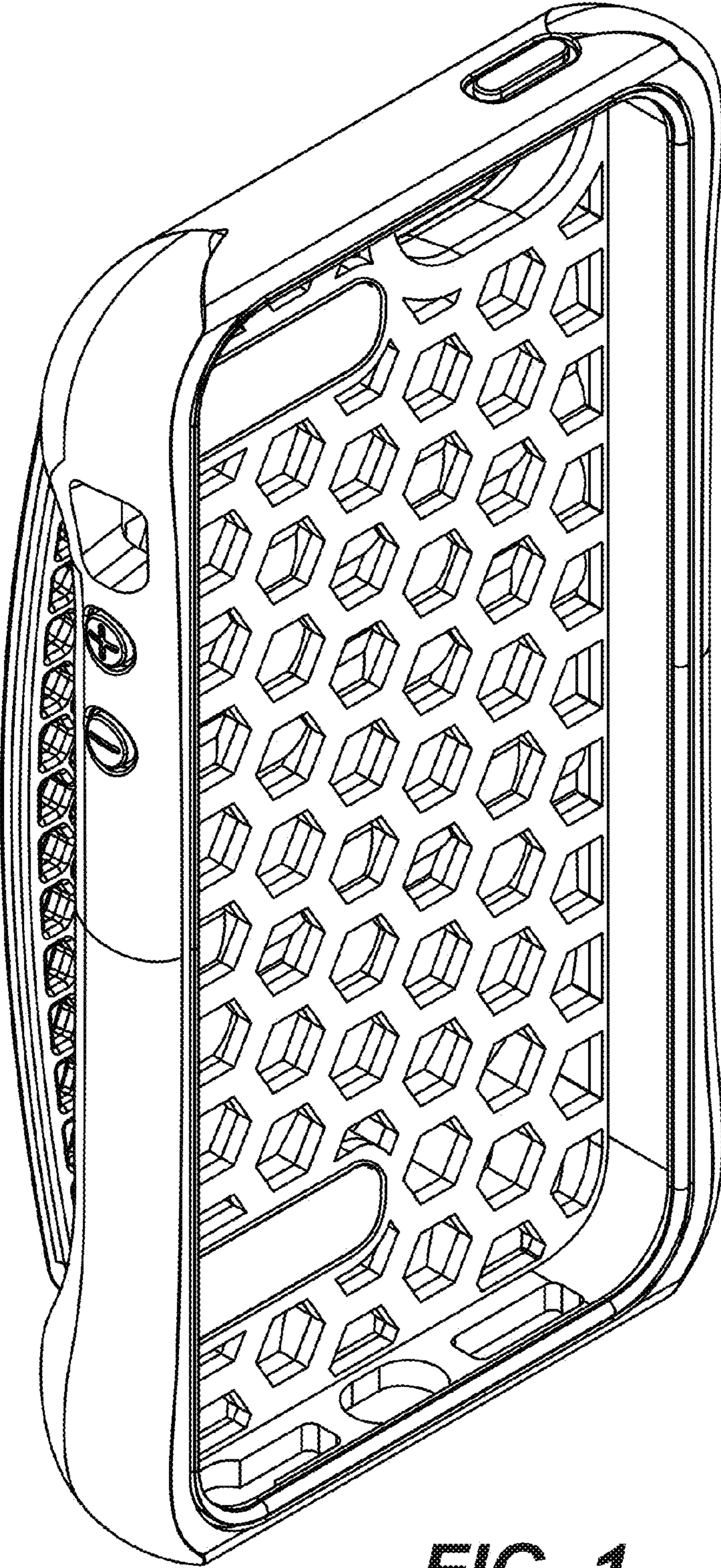

FIG. 1

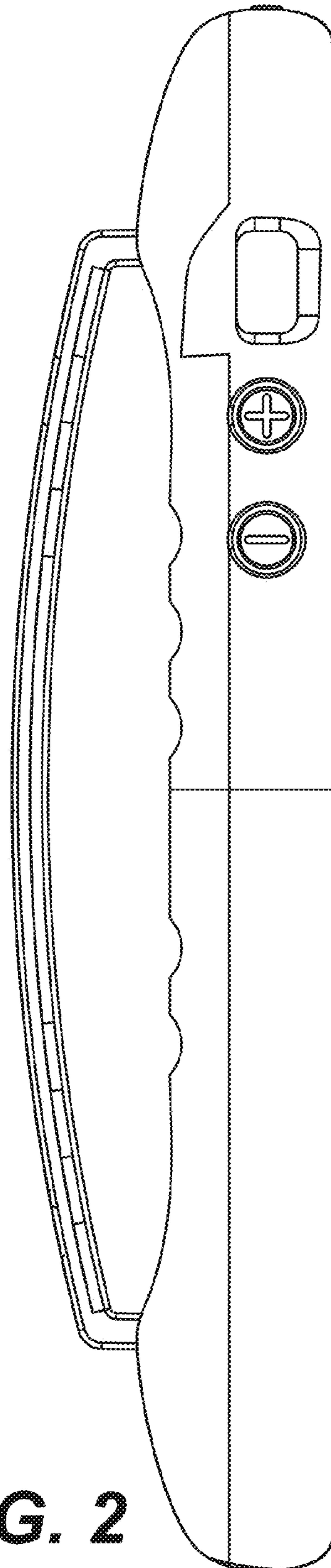

FIG. 2

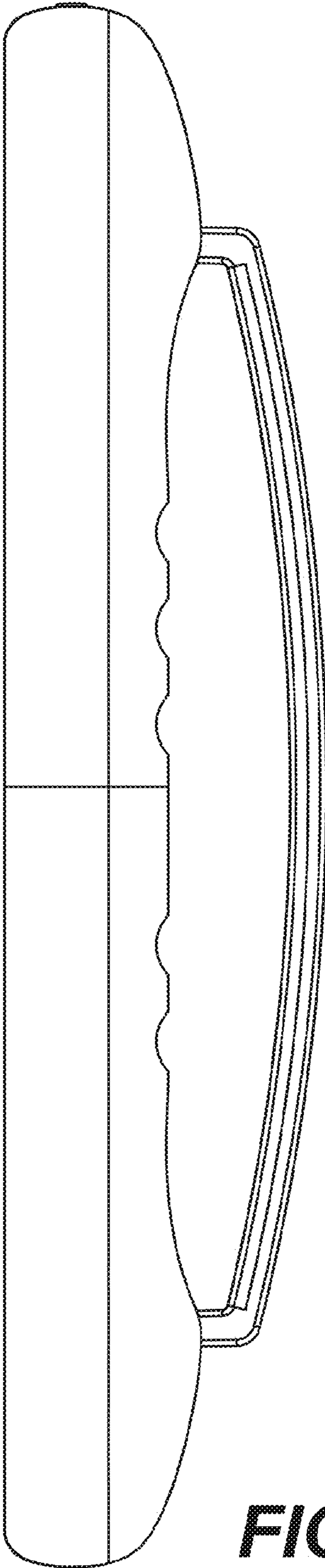

FIG. 3

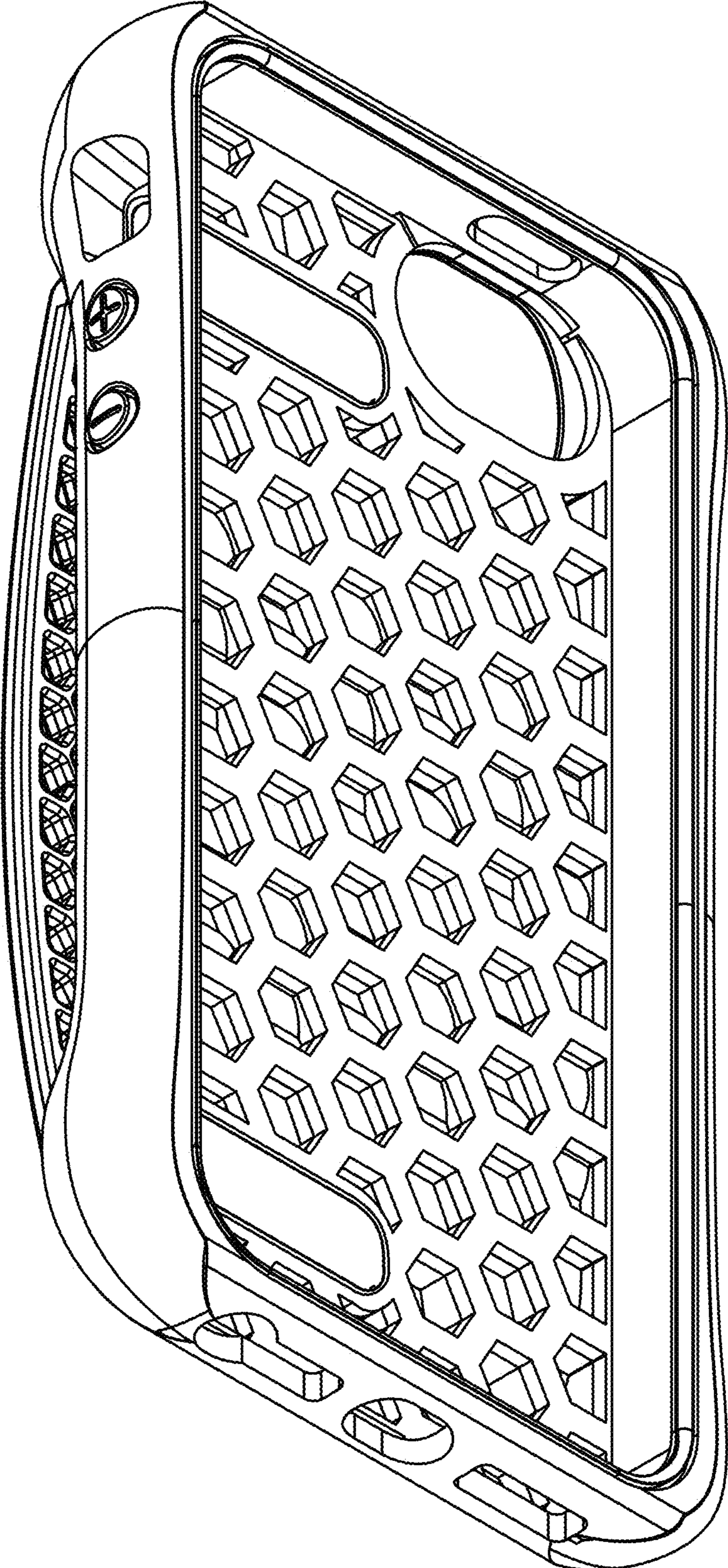

FIG. 4

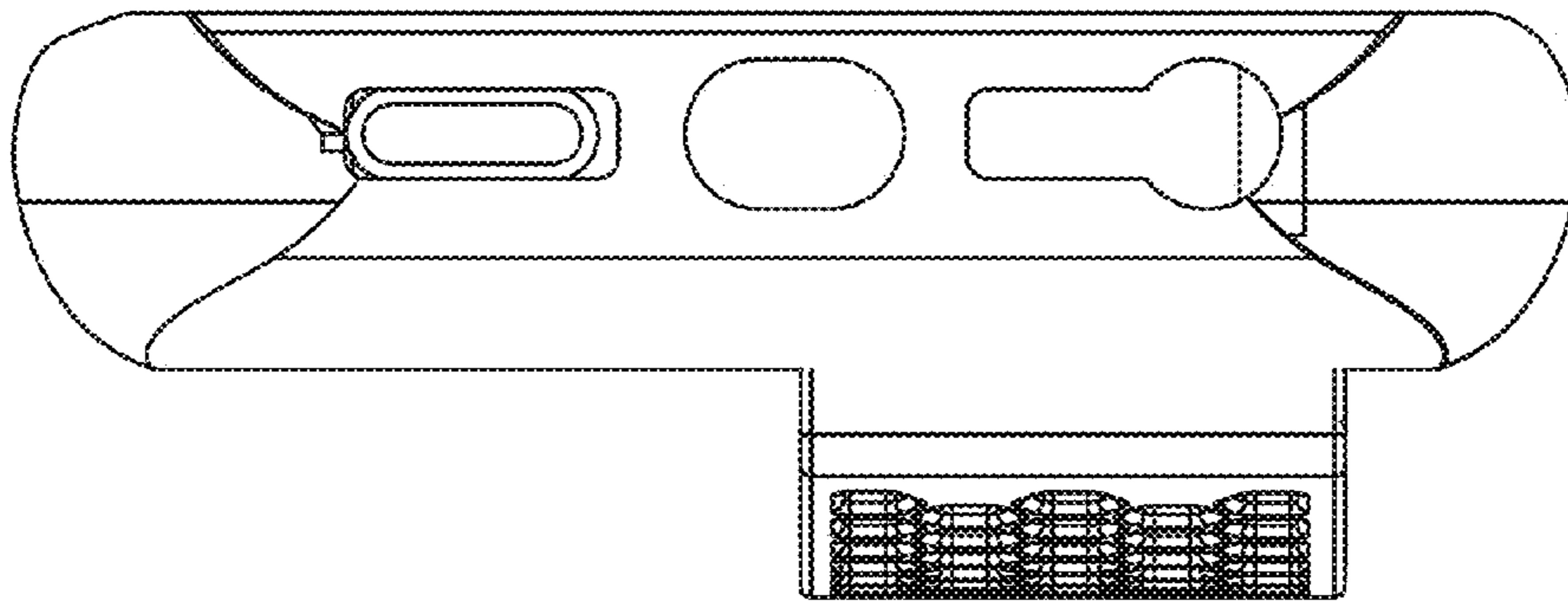

FIG. 5

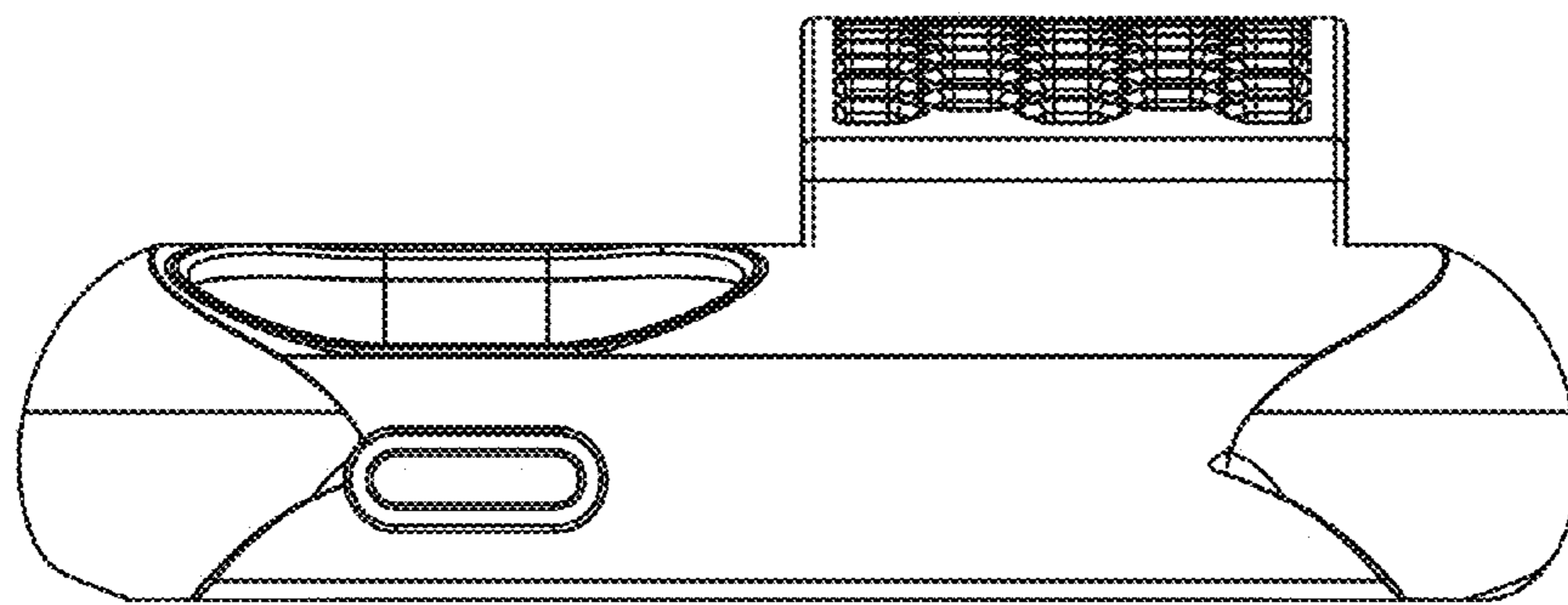

FIG. 6

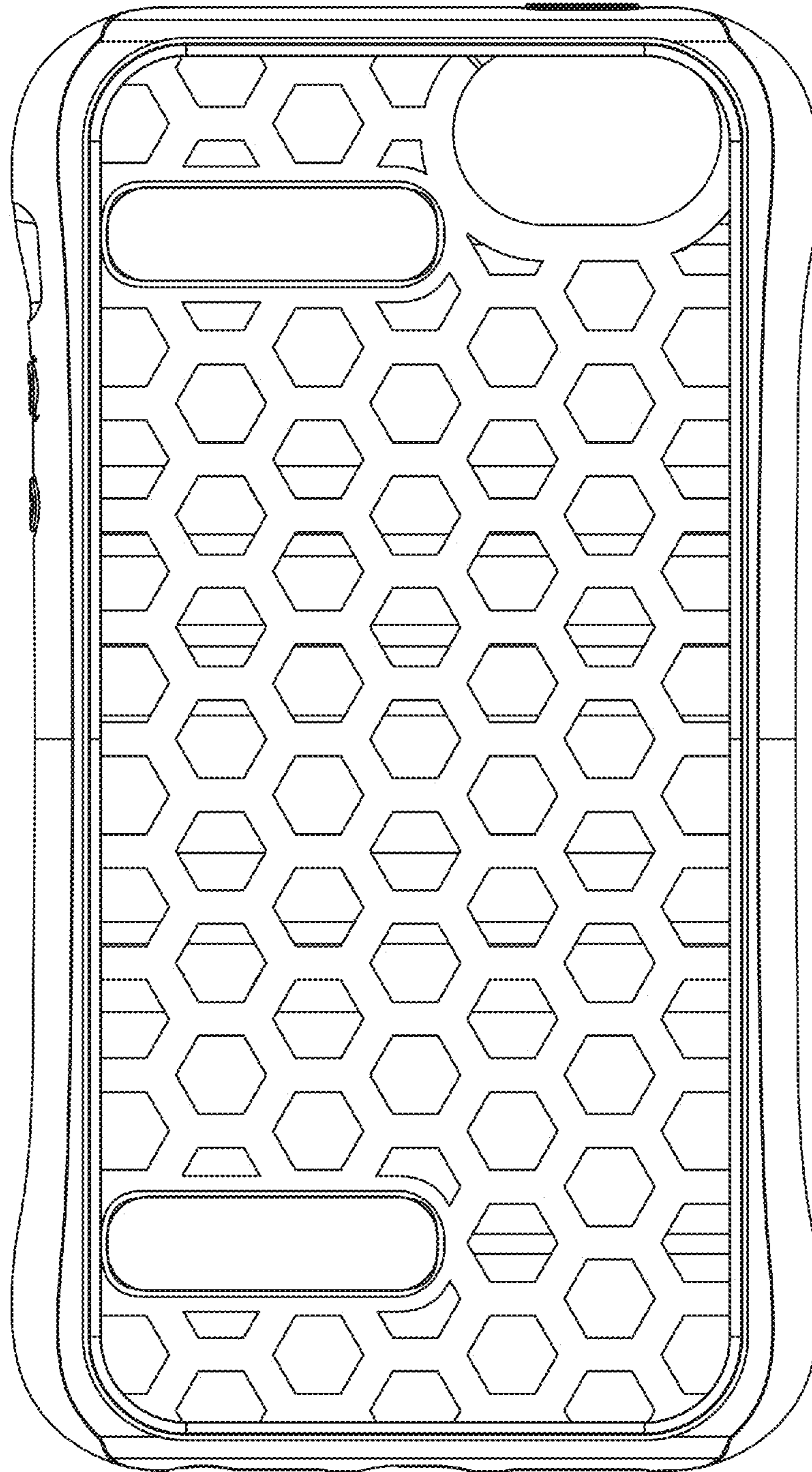

FIG. 7

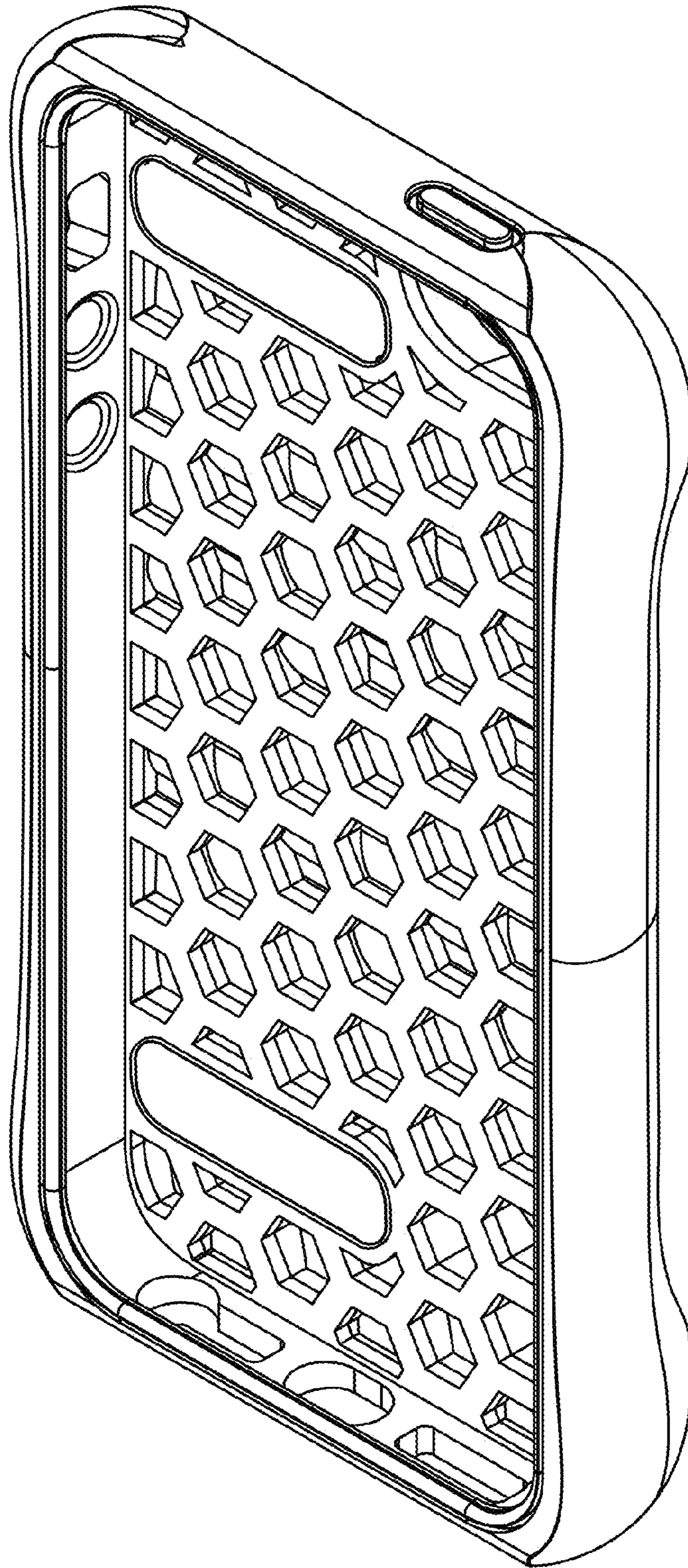

FIG. 8

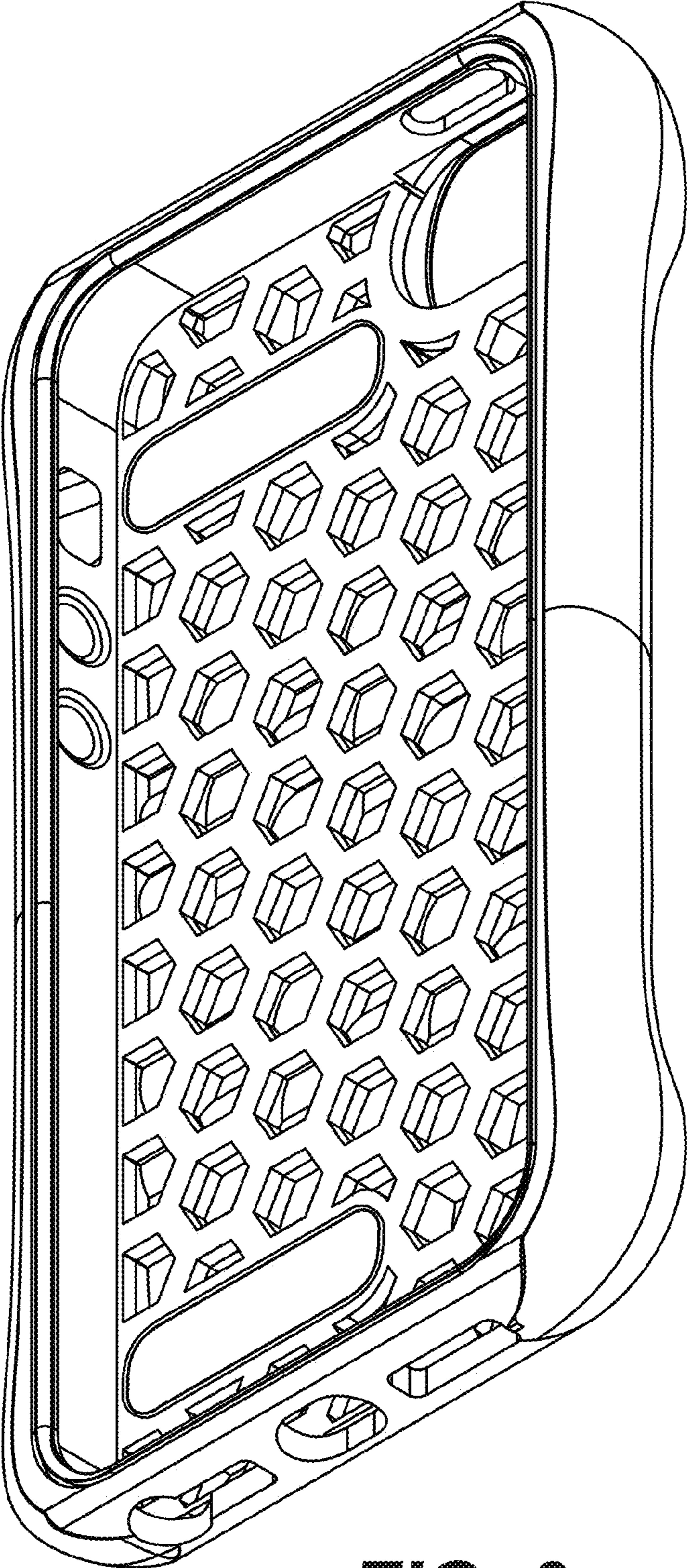

FIG. 9

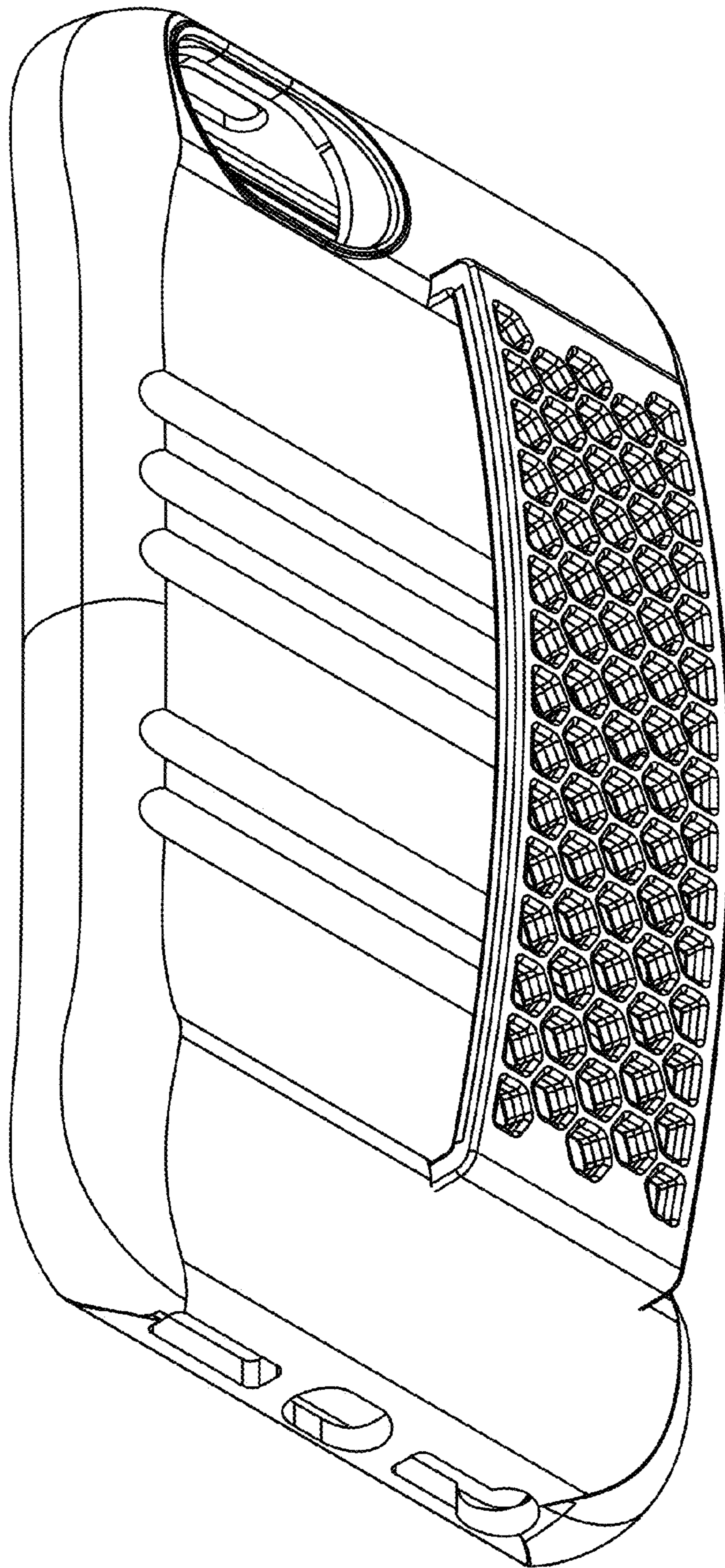

FIG. 10

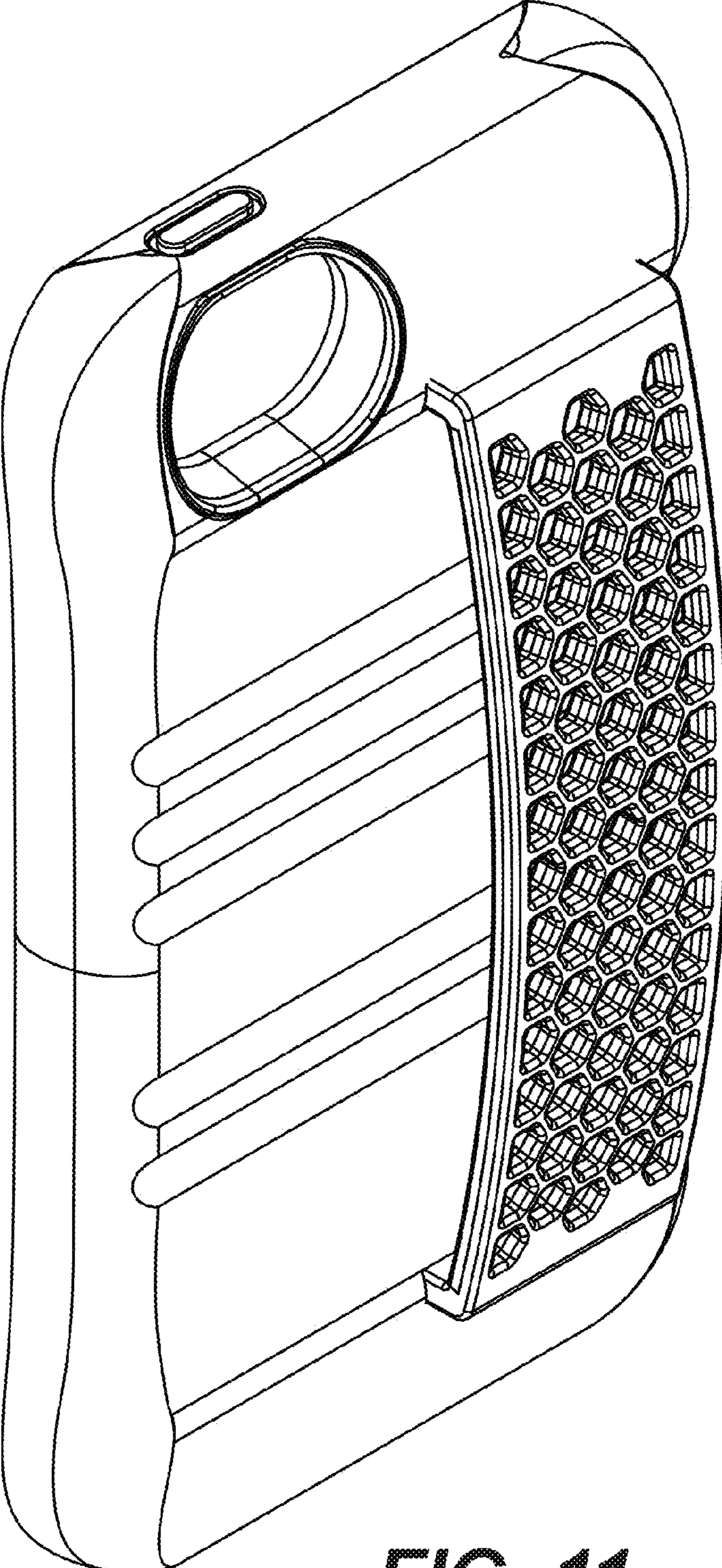

FIG. 11

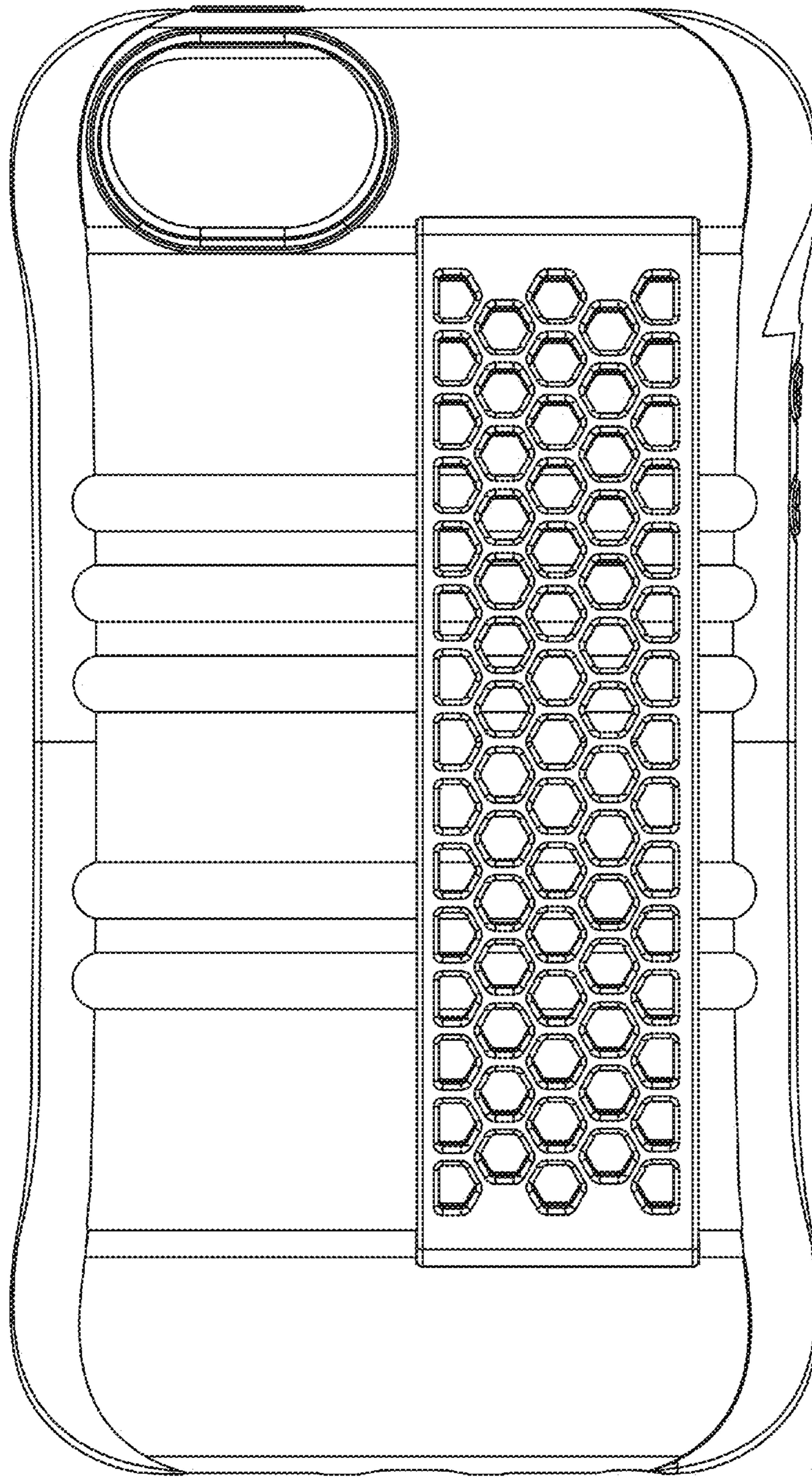

FIG. 12

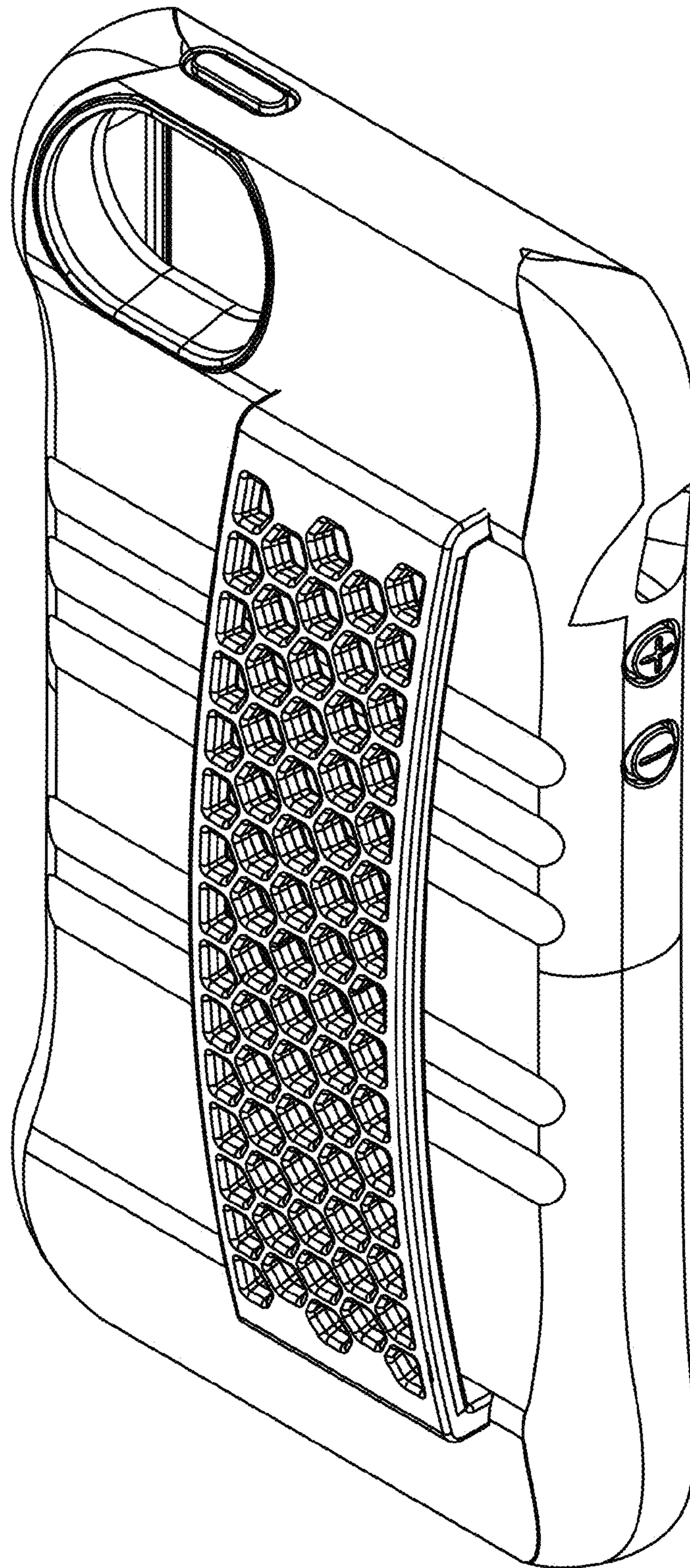

FIG. 13

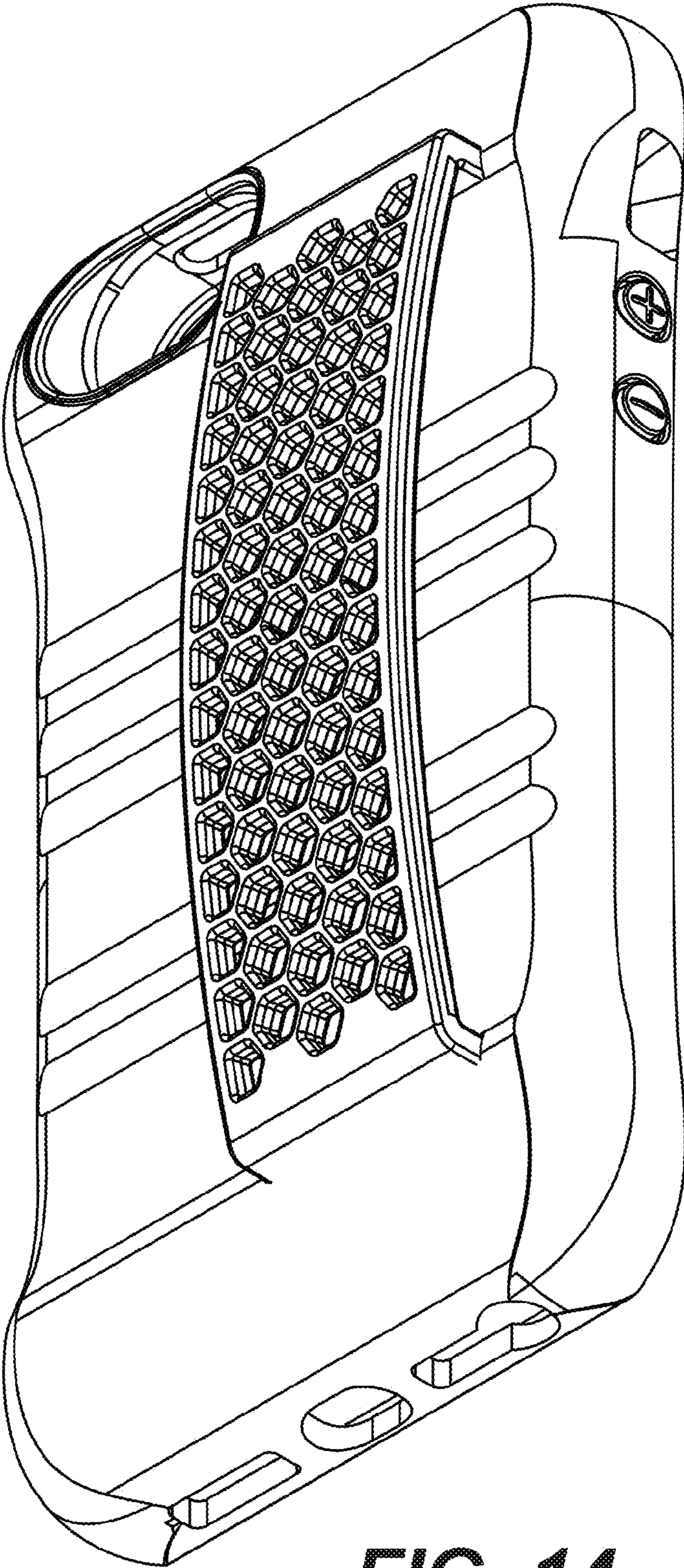

FIG. 14