



US00D733693S

(12) **United States Design Patent**
Wang et al.

(10) **Patent No.:** **US D733,693 S**
(45) **Date of Patent:** **** Jul. 7, 2015**

- (54) **PORTABLE ELECTRONIC DEVICE**
- (71) Applicant: **HTC Corporation**, Taoyuan, Taoyuan County (TW)
- (72) Inventors: **Yi-Shen Wang**, Taoyuan (TW);
Chieh-Kai Wang, Taoyuan (TW);
Hung-Yi Huang, Taoyuan (TW);
Chih-Ling Chien, Taoyuan (TW)
- (73) Assignee: **HTC Corporation**, Taoyuan (TW)
- (**) Term: **14 Years**
- (21) Appl. No.: **29/453,717**
- (22) Filed: **May 2, 2013**

- D583,346 S * 12/2008 Jung et al. D14/138 AD
- D591,252 S * 4/2009 Kim et al. D14/138 G
- D597,512 S * 8/2009 Kim et al. D14/138 G
- D615,057 S * 5/2010 Kim et al. D14/138 AB
- D617,755 S * 6/2010 Leinvuo D14/138 G

(Continued)

FOREIGN PATENT DOCUMENTS

- TW D149836 S 10/2012
- TW D153730 S 5/2013

(Continued)

OTHER PUBLICATIONS

HTC One telephone, announced Feb. 2013, [online], [site visited Sep. 14, 2014]. Available from Internet, <URL: http://www.gsmarena.com/htc_one-5313.php>.*

(Continued)

Related U.S. Application Data

- (63) Continuation-in-part of application No. 29/443,348, filed on Jan. 16, 2013.
- (51) **LOC (10) Cl.** **14-03**
- (52) **U.S. Cl.**
USPC **D14/248**
- (58) **Field of Classification Search**
USPC D14/138 R, 341, 346, 345, 138 G,
D14/138 AD, 496, 203.1, 203.3, 203.4,
D14/203.7, 248, 218, 203.5, 203.6;
455/575.1, 556.1, 556.2, 575.3, 575.4;
D21/517, 329; 379/433.01, 433.04;
D13/168, 65, 78; 361/679.3, 679.56
CPC H04M 1/02; H04M 1/0202-1/035;
G06F 1/1626; H01H 13/85
See application file for complete search history.

Primary Examiner — Jeffrey D Asch

(74) *Attorney, Agent, or Firm* — Birch, Stewart, Kolasch & Birch, LLP

(57) **CLAIM**

The ornamental design for a portable electronic device, as shown and described.

DESCRIPTION

FIG. 1 is a front perspective view of a portable electronic device in accordance with our new design;
FIG. 2 is a front view thereof;
FIG. 3 is a rear view thereof;
FIG. 4 is a left side view thereof;
FIG. 5 is a right side view thereof;
FIG. 6 is a top plan view thereof;
FIG. 7 is a bottom plan view thereof; and,
FIG. 8 is a rear perspective view thereof.
The broken lines, which show portions of a portable electronic device, form no part of the claimed design.

(56) **References Cited**

U.S. PATENT DOCUMENTS

- D484,874 S * 1/2004 Chang et al. D14/250
- D554,099 S * 10/2007 Kim et al. D14/138 AD
- D581,384 S * 11/2008 Kim et al. D14/138 AD

1 Claim, 7 Drawing Sheets

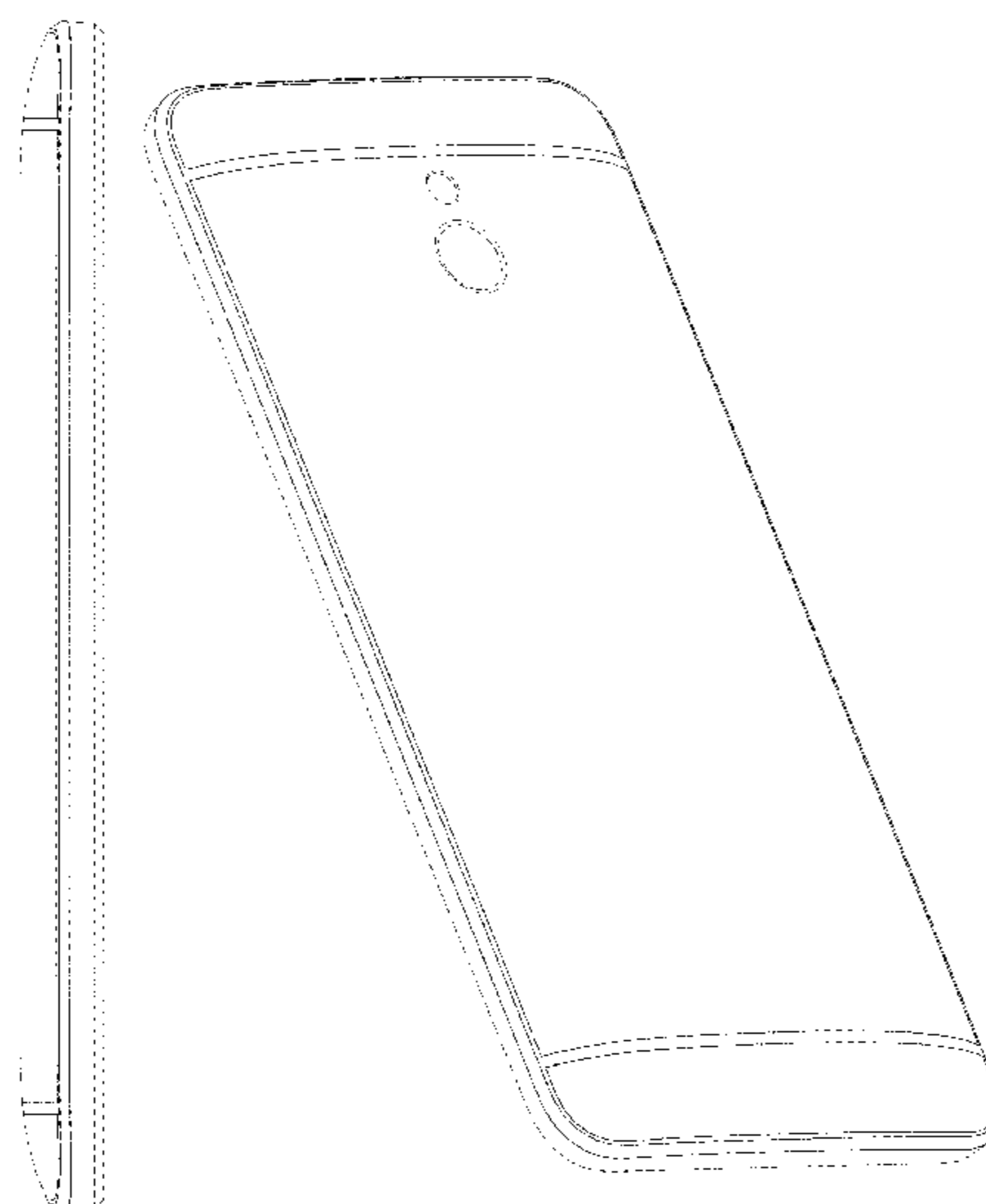

(56)

References Cited

U.S. PATENT DOCUMENTS

D620,003 S * 7/2010 Chiang et al. D14/341
 D622,248 S * 8/2010 Kwon et al. D14/138 G
 D627,782 S * 11/2010 Ichise D14/346
 7,831,286 B2 * 11/2010 Cho et al. 455/575.4
 D639,805 S * 6/2011 Song et al. D14/341
 D645,441 S * 9/2011 Choe et al. D14/138 G
 D646,248 S * 10/2011 Lee D14/138 G
 D651,601 S * 1/2012 Ichise D14/341
 D659,664 S * 5/2012 Park et al. D14/138 AD
 D663,709 S * 7/2012 Kim et al. D14/138 AD
 8,253,650 B2 * 8/2012 Sip et al. 345/1.3
 D668,652 S * 10/2012 Kim et al. D14/341
 D669,082 S * 10/2012 Sato D14/425
 D676,819 S * 2/2013 Choi D14/138 G
 D677,233 S * 3/2013 Mauritzson D14/138 G
 D677,234 S * 3/2013 Hirano D14/138 G
 D677,235 S * 3/2013 Hibi D14/138 G
 D677,642 S * 3/2013 Park D14/138 G
 D680,984 S * 4/2013 Harmon et al. D14/138 G
 D680,995 S * 4/2013 Lee D14/138 G
 D683,325 S * 5/2013 Sugiyama D14/138 G
 D683,711 S * 6/2013 Hofer et al. D14/138 G
 D683,713 S * 6/2013 Hofer et al. D14/138 G
 D685,365 S * 7/2013 Murchison et al. D14/250
 D688,218 S * 8/2013 Lee D14/138 G
 D692,872 S * 11/2013 Hofer et al. D14/248
 D695,704 S * 12/2013 Kim et al. D14/138 G
 D696,656 S * 12/2013 Murchison et al. D14/250
 D697,887 S * 1/2014 Yin et al. D14/138 G
 8,634,884 B2 * 1/2014 Kim et al. 455/575.4
 D698,773 S * 2/2014 Wildner D14/250
 D707,670 S * 6/2014 Chang et al. D14/250
 D708,161 S * 7/2014 Ishida D14/138 G
 D710,815 S * 8/2014 Kim et al. D14/138 G
 D711,341 S * 8/2014 Shin et al. D14/138 G
 D717,265 S * 11/2014 Zhao D14/138 G
 8,914,060 B2 * 12/2014 Kim et al. 455/550.1
 2009/0303199 A1 * 12/2009 Cho et al. 345/173
 2012/0069504 A1 * 3/2012 Ho et al. 361/679.01
 2013/0165189 A1 * 6/2013 Shoji et al. 455/575.1
 2014/0085777 A1 * 3/2014 Yeh et al. 361/679.01
 2014/0284096 A1 * 9/2014 Wu et al. 174/520
 2014/0286523 A1 * 9/2014 Yeh et al. 381/394
 2014/0378190 A1 * 12/2014 Hsu 455/575.1

FOREIGN PATENT DOCUMENTS

TW D156142 S1 9/2013
 TW D157832 S 12/2013
 TW D158992 S 2/2014
 TW D159657 S 4/2014

OTHER PUBLICATIONS

HTC One mini telephone, announced Jul. 2013, [online], [site visited Sep. 14, 2014]. Available from Internet, <URL: http://www.gsmarena.com/htc_one_mini-5505.php>.*
 HTC One Max telephone, announced Oct. 2013, [online], [site visited Sep. 14, 2014]. Available from Internet, <URL: http://www.gsmarena.com/htc_one_max-5704.php>.*
 HTC Desire 700 dual sim telephone, announced Nov. 2013, [online], [site visited Sep. 14, 2014]. Available from Internet, <URL: http://www.gsmarena.com/htc_desire_700_dual_sim-5870.php>.*
 BlackBerry Z10 telephone, announced Jan. 2013, [online], [site visited Sep. 14, 2014]. Available from Internet, <URL: http://www.gsmarena.com/blackberry_z10-5251.php>.*
 Gigabyte GSmart Roma R2 telephone, announced Oct. 2013, [online], [site visited Sep. 14, 2014]. Available from Internet, <URL: http://www.gsmarena.com/gigabyte_gsmart_roma_r2-5808.php>.*
 Karbonn Titanium Hexa telephone, announced Mar. 2014, [online], [site visited Sep. 14, 2014]. Available from Internet, <URL: http://www.gsmarena.com/karbonn_titanium_hexa-6218.php>.*
 LG Optimus 3D P920 telephone, announced Jan. 2011, [online], [site visited Sep. 14, 2014]. Available from Internet, <URL: http://www.gsmarena.com/lg_optimus_3d_p920-3759.php>.*
 Huawei MediaPad M1, announced Feb. 2014, [online], [site visited Sep. 14, 2014]. Available from Internet, <URL: http://www.gsmarena.com/huawei_mediapad_m1-6137.php>.*
 Celkon AR40 telephone, announced Dec. 2013, [online], [site visited Sep. 14, 2014]. Available from Internet, <URL: http://www.gsmarena.com/celkon_ar40-5916.php>.*
 HTC Desire 601 telephone, announced Sep. 2013, [online], [site visited Sep. 14, 2014]. Available from Internet, <URL: http://www.gsmarena.com/htc_desire_601-5667.php>.*

* cited by examiner

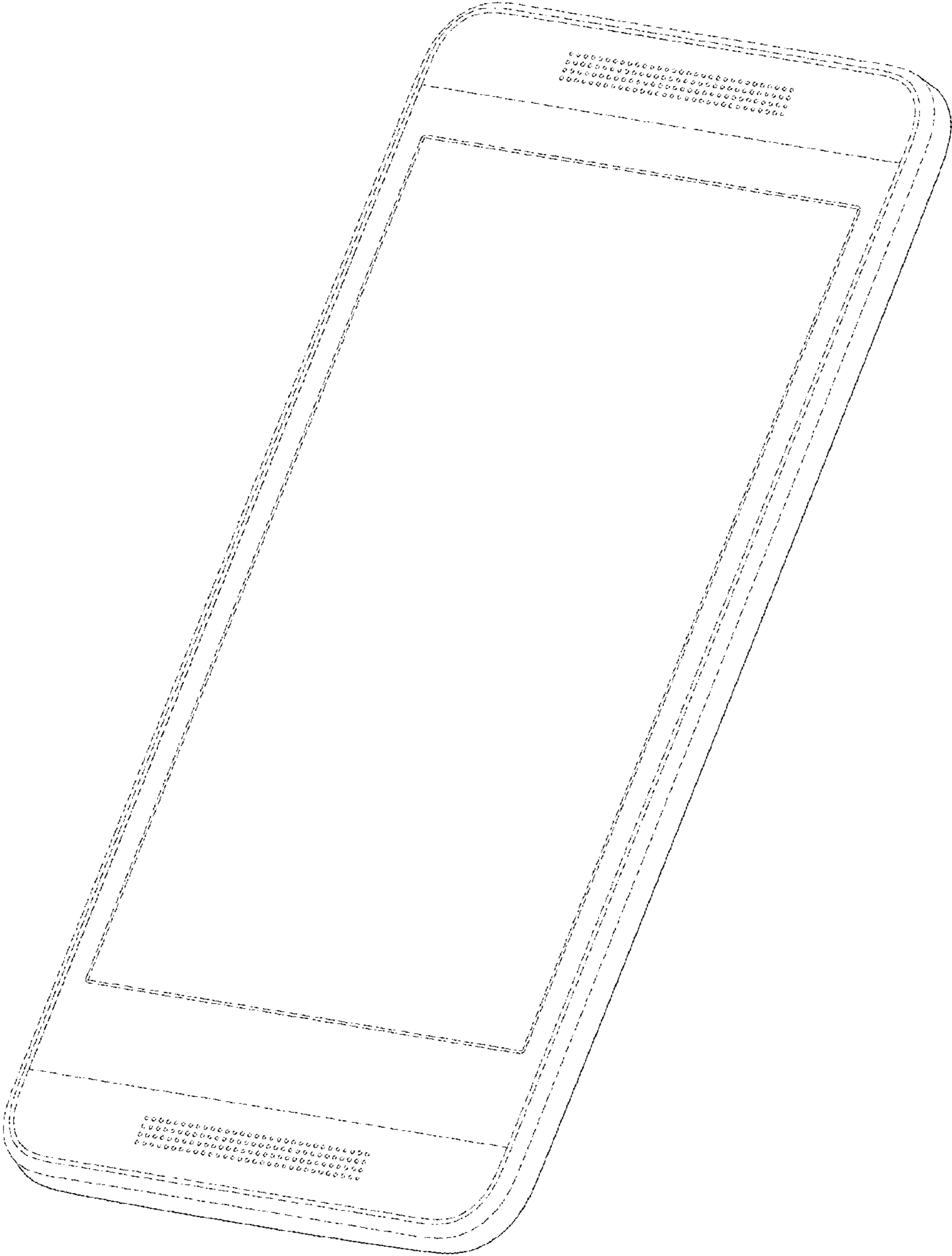

FIG. 1

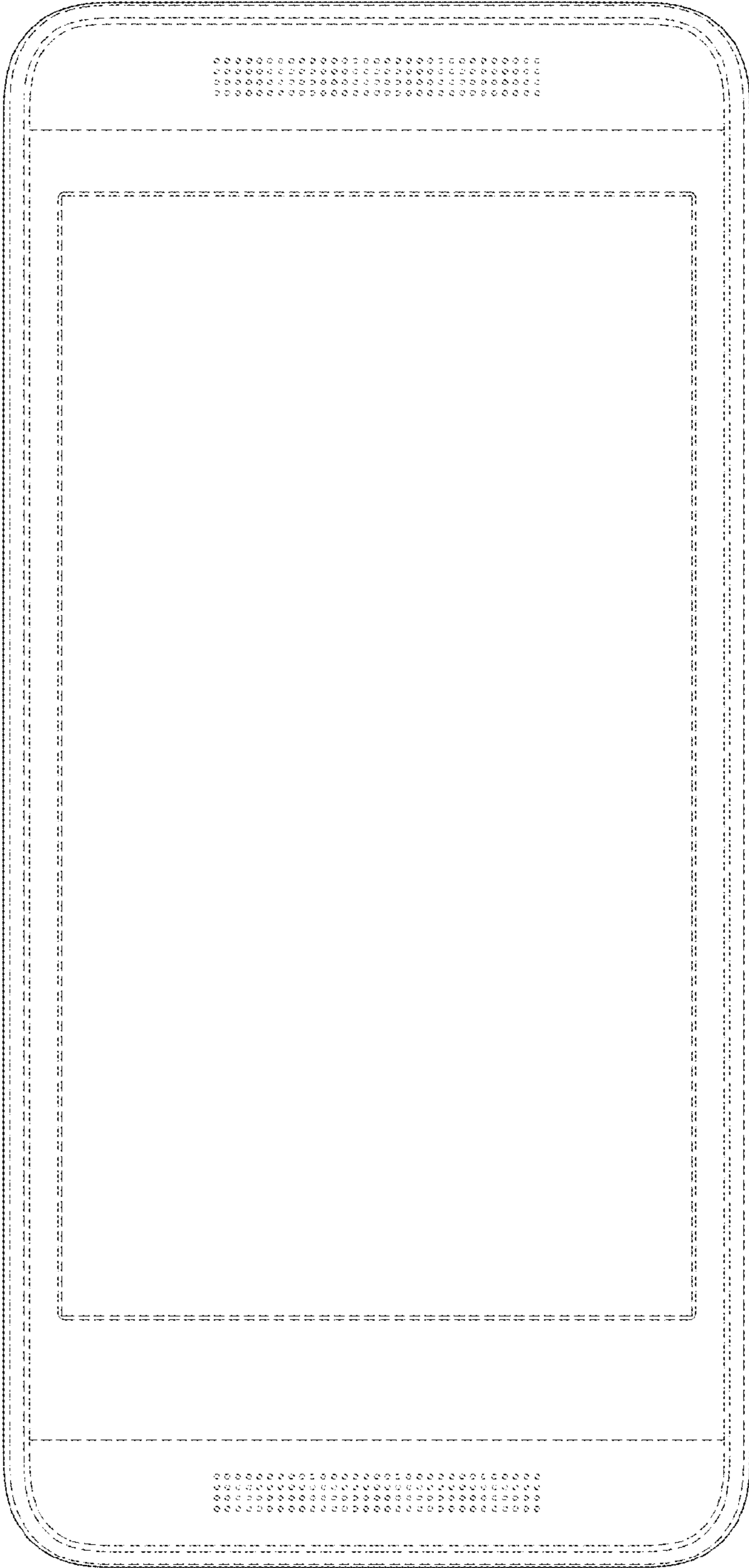

FIG. 2

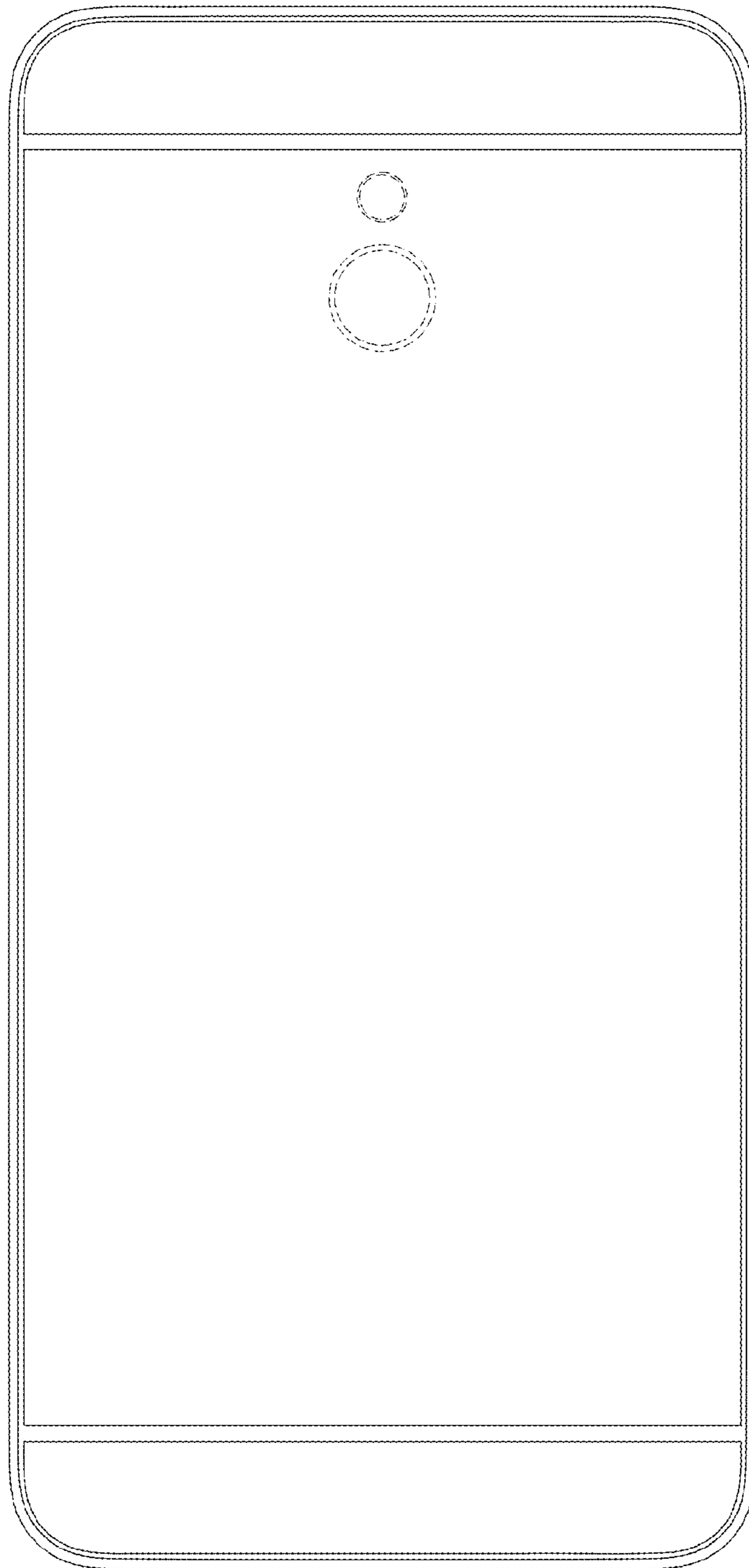

FIG. 3

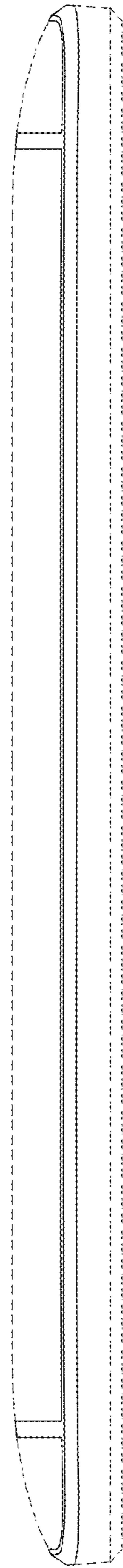

FIG. 4

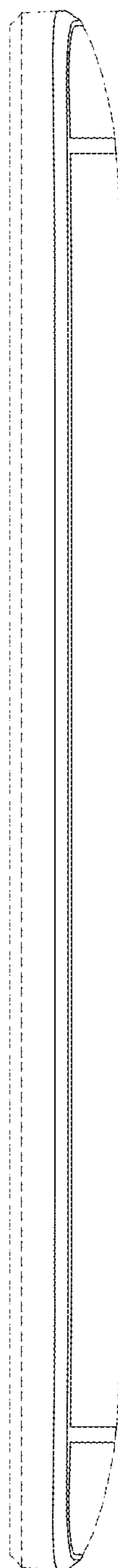

FIG. 5

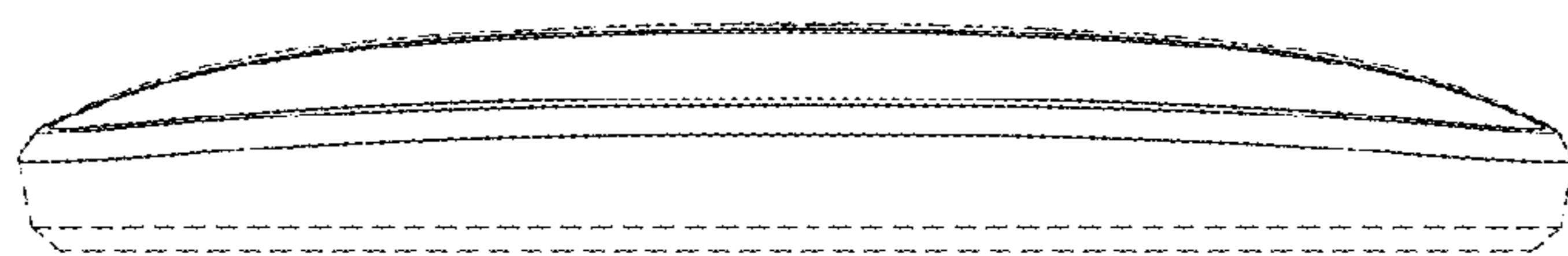

FIG. 6

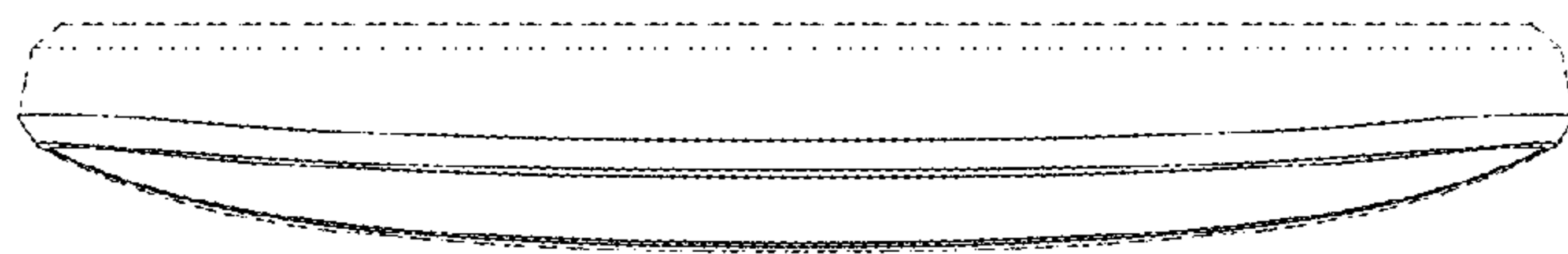

FIG. 7

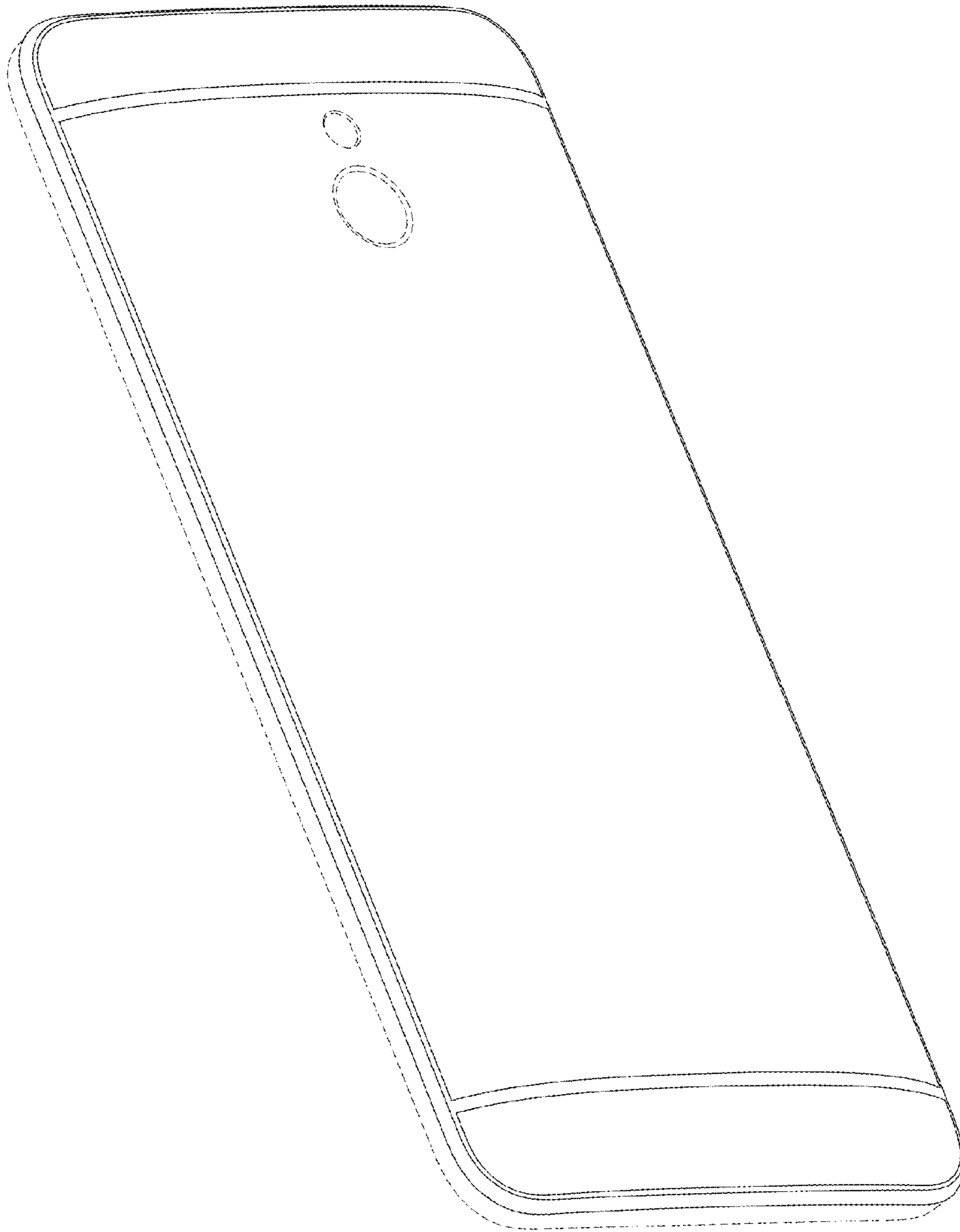

FIG. 8