



US00D733671S

(12) **United States Design Patent**
Lu et al.

(10) **Patent No.:** **US D733,671 S**
(45) **Date of Patent:** **** Jul. 7, 2015**

(54) **TELEVISION SET**

(71) Applicants: **Yen-Wen Lu**, Taipei (TW); **Kuei-Min Pan**, Taipei (TW)

(72) Inventors: **Yen-Wen Lu**, Taipei (TW); **Kuei-Min Pan**, Taipei (TW)

(73) Assignee: **COMPAL ELECTRONICS, INC.**, Taipei (TW)

(**) Term: **14 Years**

(21) Appl. No.: **29/456,751**

(22) Filed: **Jun. 4, 2013**

(51) **LOC (10) Cl.** **14-03**

(52) **U.S. Cl.**
USPC **D14/126**

(58) **Field of Classification Search**
USPC D14/125-134, 239, 371, 136, 374-377,
D14/440, 450, 448, 336, 342, 159; 312/7.2;
348/836, 838, 180, 184, 325, 739;
248/917-924, 465; 345/104, 133, 156,
345/168, 87, 173; D21/329, 515, 577, 622,
D21/333, 433, 448, 452, 450, 331, 505;
D10/15, 26; 446/484, 175, 356;
D6/477, 479, 300; D24/185; D34/14
CPC ... G06F 1/1601; G06F 1/1643; H05K 5/0004;
H05K 5/0017; H05K 5/02; H05K 5/0217
See application file for complete search history.

(56) **References Cited**

U.S. PATENT DOCUMENTS

D670,257 S *	11/2012	Yang et al.	D14/126
D691,102 S *	10/2013	Park et al.	D14/126
D719,539 S *	12/2014	Ryu et al.	D14/126
D721,049 S *	1/2015	Lee	D14/126

* cited by examiner

Primary Examiner — Raphael Barkai

(74) *Attorney, Agent, or Firm* — Jianq Chyun IP Office

(57) **CLAIM**

The ornamental design for a television set, as shown and described.

DESCRIPTION

FIG. 1 is a perspective view of a television set showing our new design;

FIG. 2 is another perspective view thereof;

FIG. 3 is a front view thereof;

FIG. 4 is a rear view thereof;

FIG. 5 is a left side view thereof;

FIG. 6 is a right side view thereof;

FIG. 7 is a top view thereof; and,

FIG. 8 is a bottom view thereof.

The broken line portions of the television set in FIGS. 1-8 represent unclaimed portions of the claimed design and form no part thereof.

1 Claim, 7 Drawing Sheets

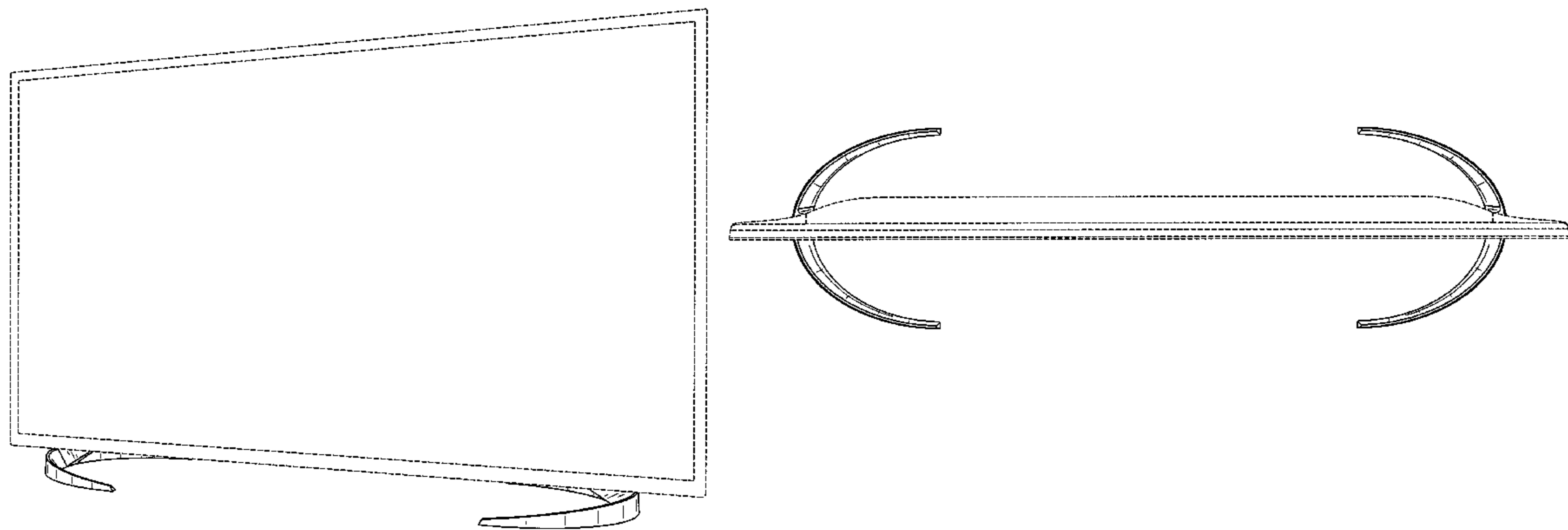

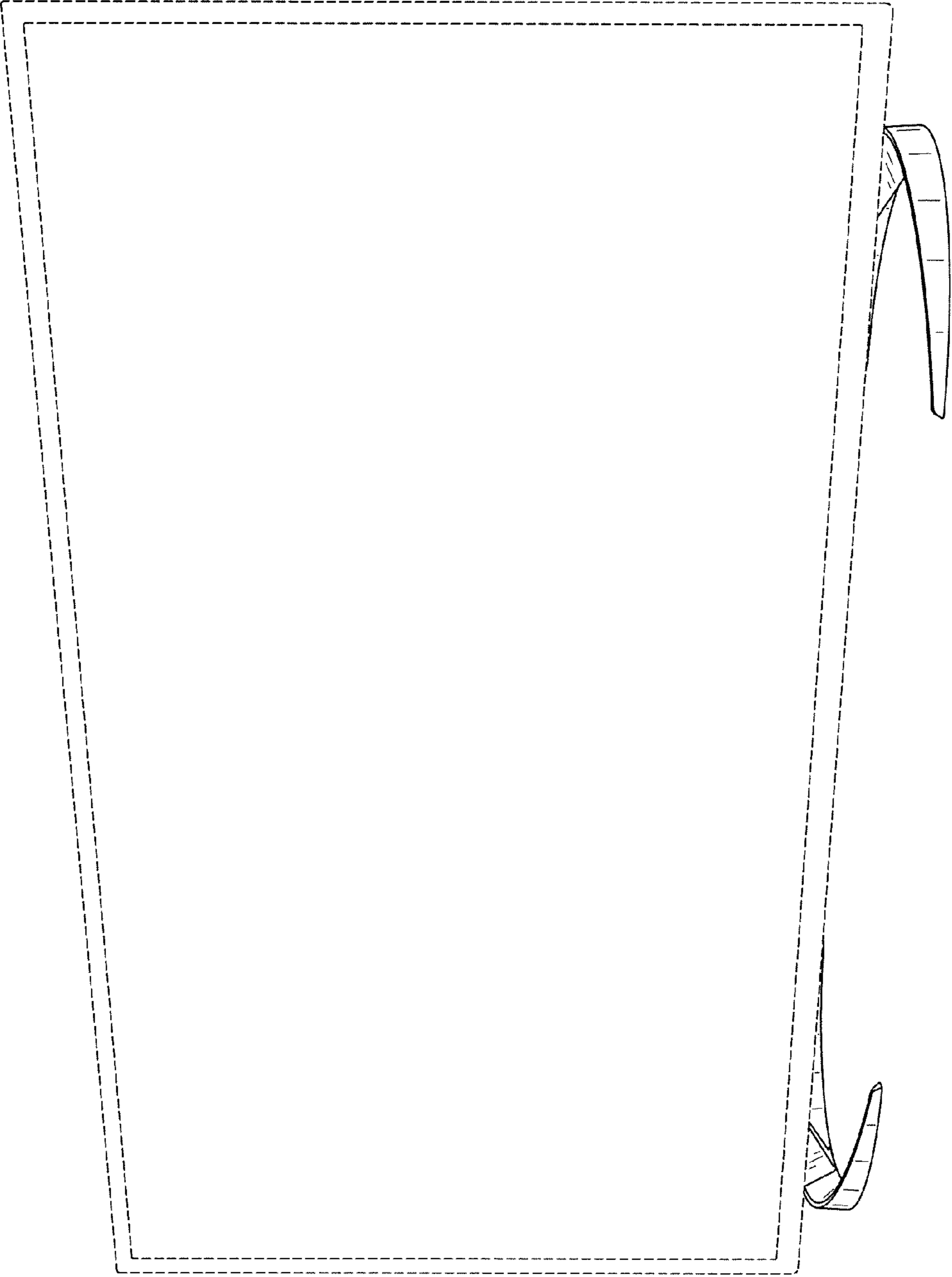

FIG. 1

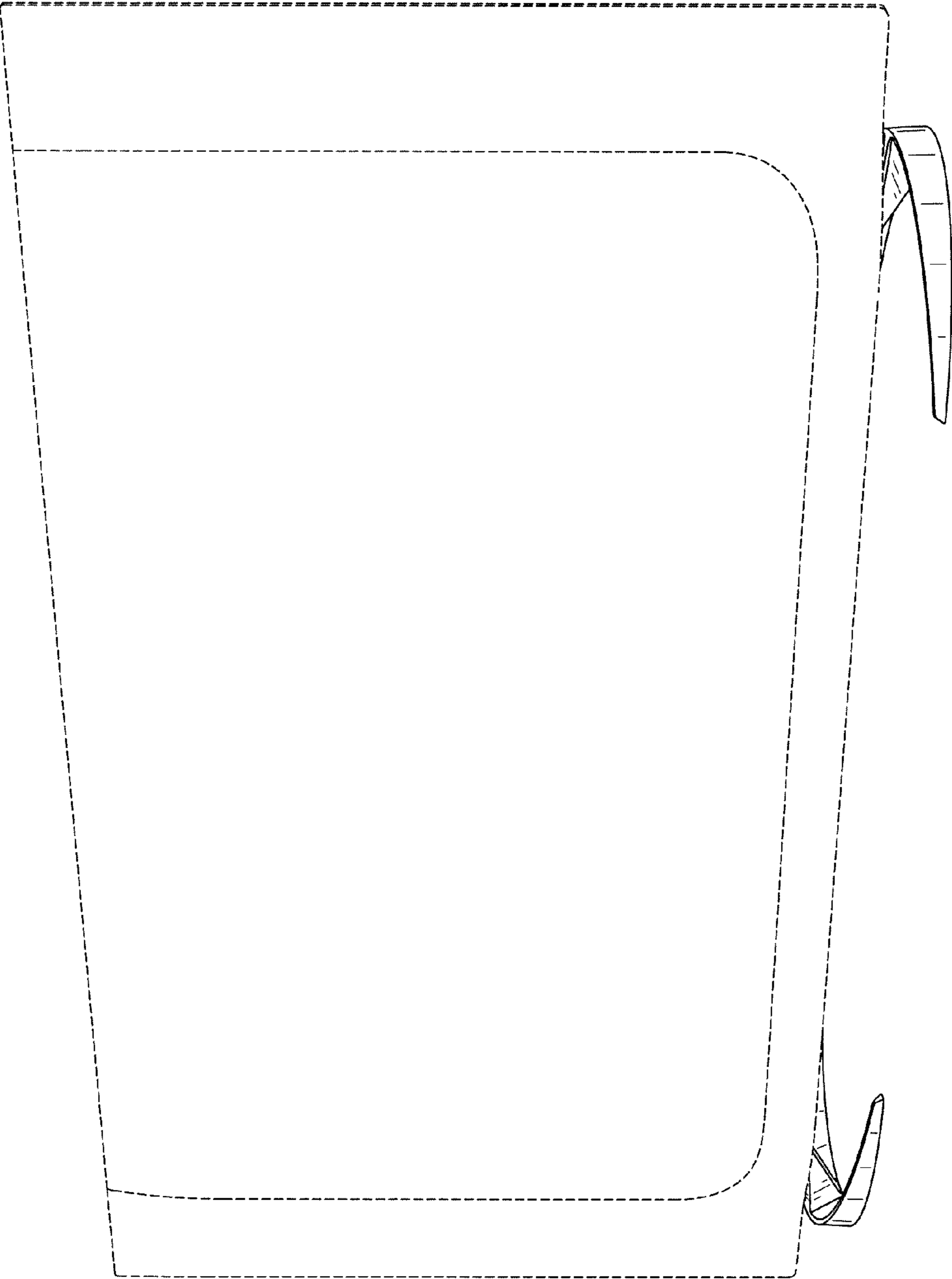

FIG. 2

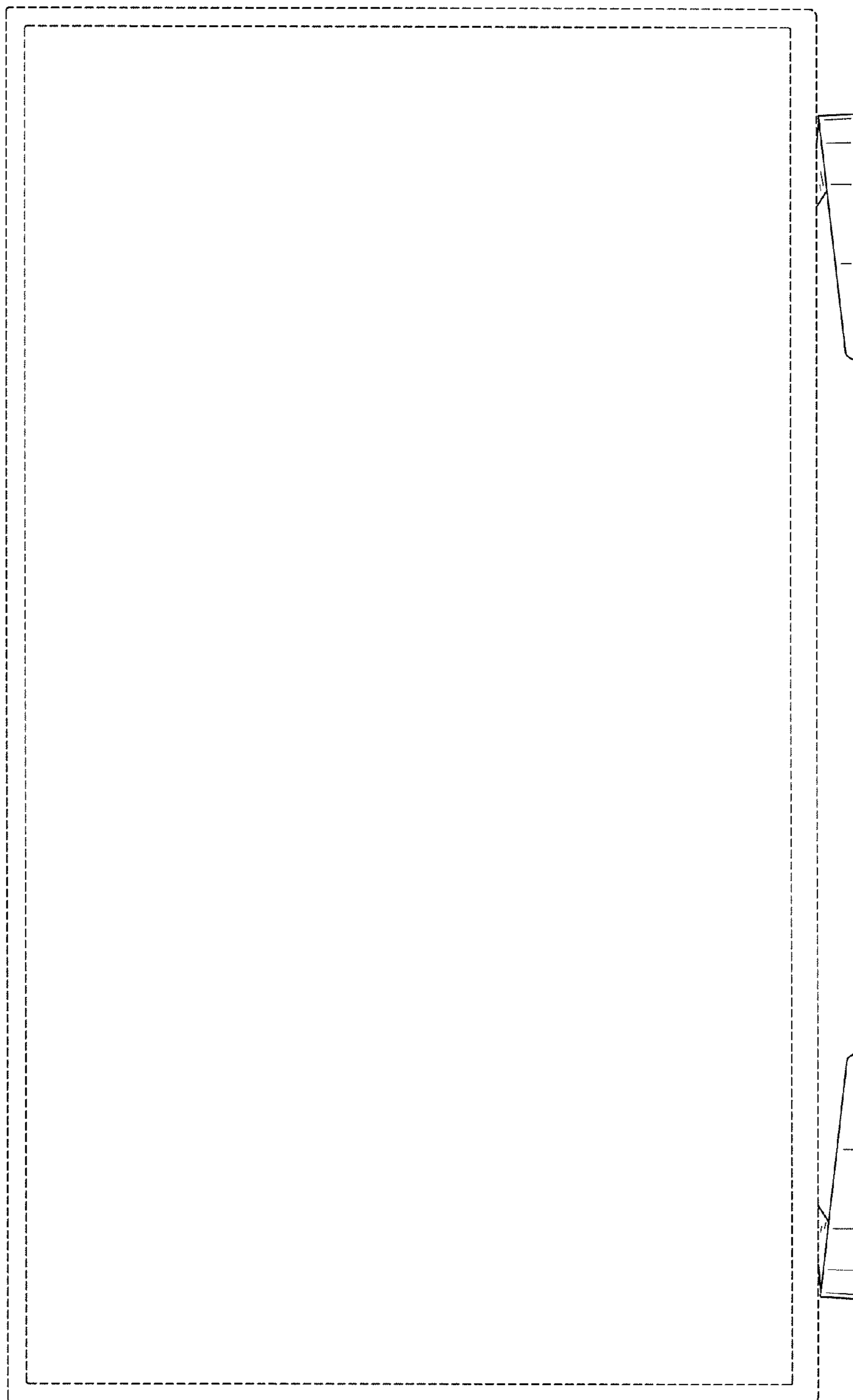

FIG. 3

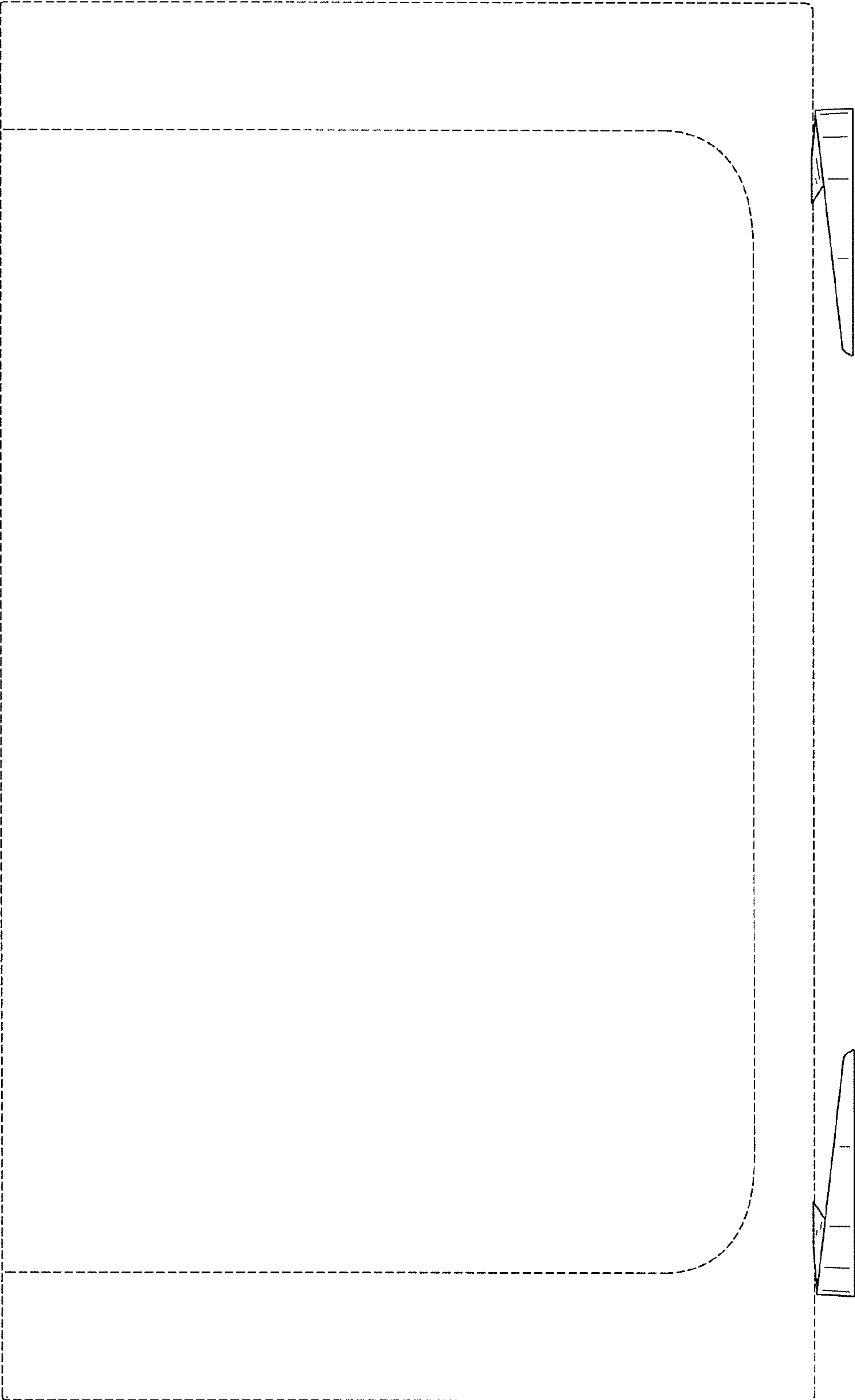

FIG. 4

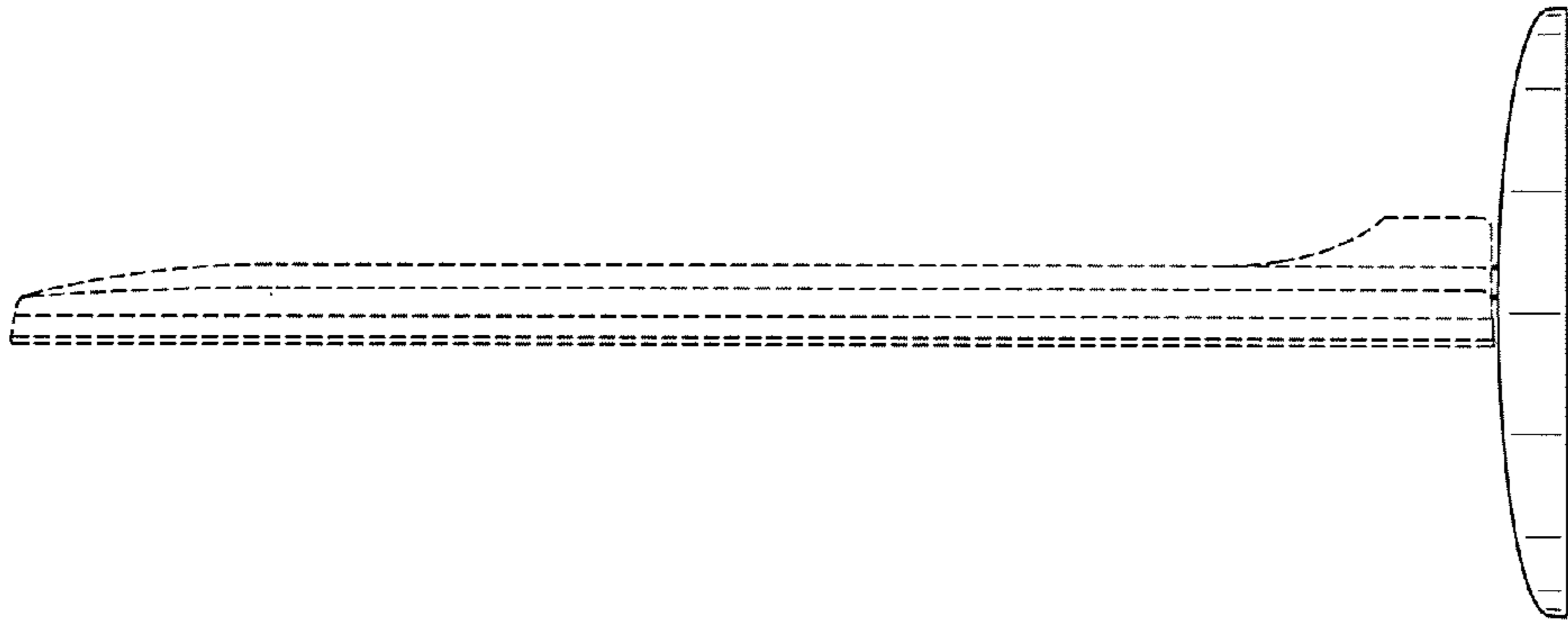

FIG. 6

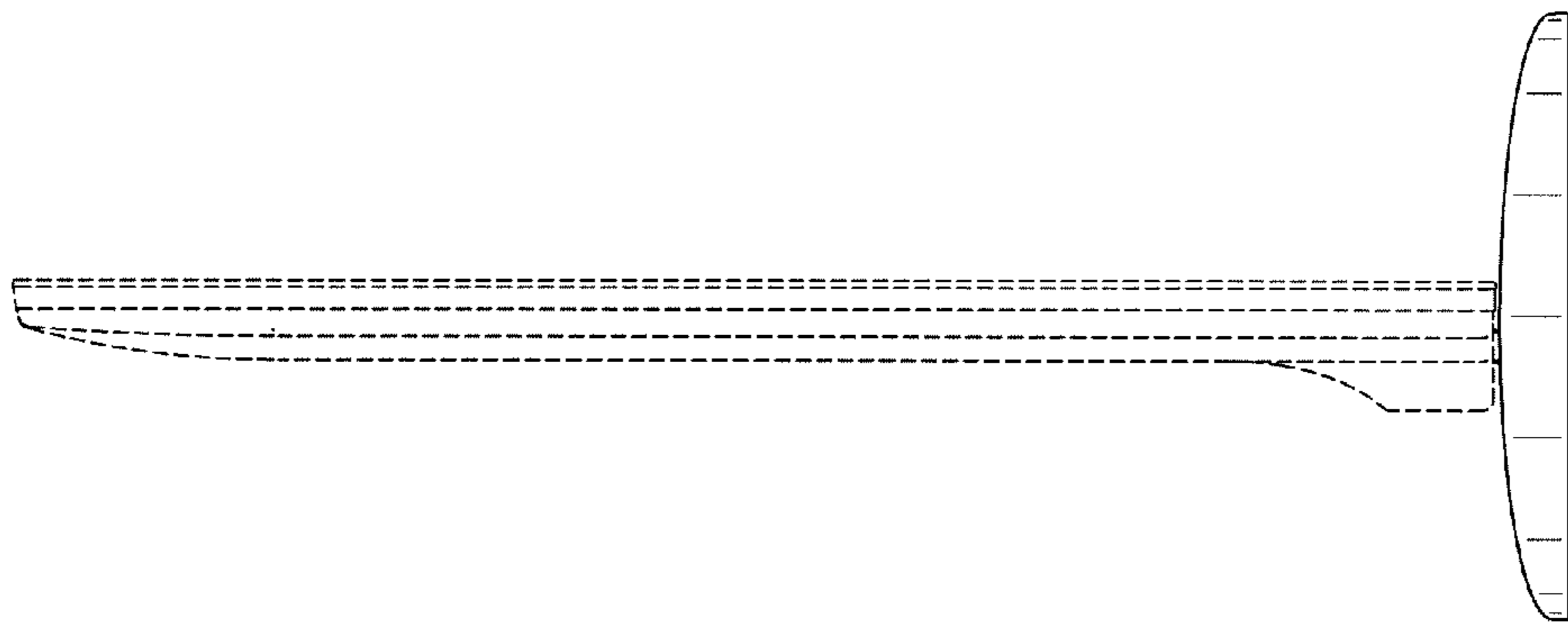

FIG. 5

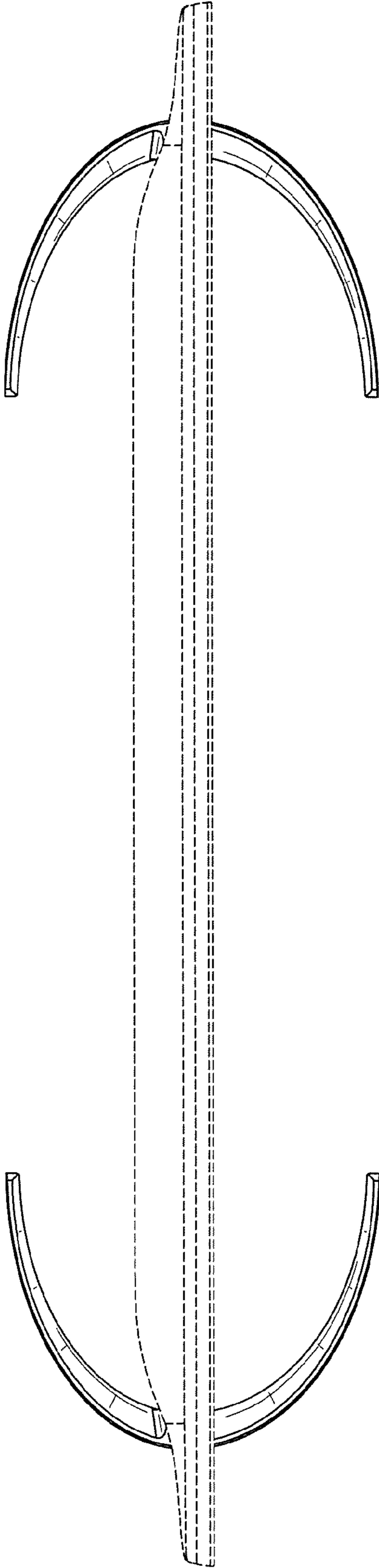

FIG. 7

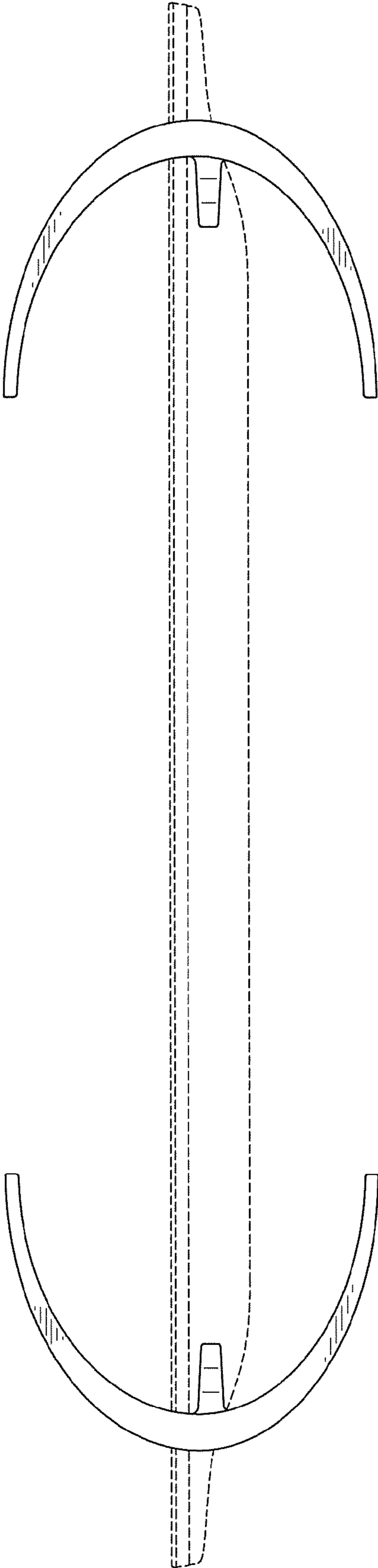

FIG. 8