



US00D733664S

(12) **United States Design Patent**  
**Baldwin et al.**

(10) **Patent No.:** **US D733,664 S**

(45) **Date of Patent:** **\*\* Jul. 7, 2015**

(54) **CABLE RAIL**

(71) Applicants: **Jeffrey Baldwin**, Desert Hills, AZ (US);  
**John Klein**, Gilbert, AZ (US); **Ryan Liebengood**, Gilbert, AZ (US)

(72) Inventors: **Jeffrey Baldwin**, Desert Hills, AZ (US);  
**John Klein**, Gilbert, AZ (US); **Ryan Liebengood**, Gilbert, AZ (US)

(\*\*) Term: **14 Years**

(21) Appl. No.: **29/489,866**

(22) Filed: **May 3, 2014**

(51) **LOC (10) Cl.** ..... **13-03**

(52) **U.S. Cl.**  
USPC ..... **D13/155**

(58) **Field of Classification Search**  
USPC ..... D13/155, 153, 154, 156, 157, 184, 199;  
D8/349, 354, 356, 377, 394; 174/50,  
174/68.1, 68.2, 68.3, 135, 136; 248/49, 53,  
248/60; 361/827; 385/134, 135; 439/207,  
439/210, 445, 446, 447, 527;  
D25/119-125, 164, 199  
CPC ..... H01B 7/00; H02G 3/00; H02G 3/04;  
H02G 3/10; H02G 3/0608  
See application file for complete search history.

(56) **References Cited**

**U.S. PATENT DOCUMENTS**

5,523,529 A \* 6/1996 Holliday ..... 174/101  
D380,736 S \* 7/1997 Theis et al. .... D13/155  
D404,010 S \* 1/1999 Viklund et al. .... D13/155

D498,211 S 11/2004 Thibault  
D503,968 S 4/2005 Ruddick  
D503,969 S 4/2005 Ruddick  
D504,938 S 5/2005 Ruddick  
D539,752 S 4/2007 Ruddick  
D541,143 S 4/2007 Ruddick  
7,375,280 B2 \* 5/2008 VanderVelde et al. .... 174/72 A  
7,696,434 B2 4/2010 Ruddick  
D626,817 S \* 11/2010 Donowho et al. .... D8/356  
D635,935 S \* 4/2011 Donowho ..... D13/156  
D669,035 S 10/2012 Ruddick  
D671,502 S 11/2012 Ruddick  
D683,318 S 5/2013 Ruddick

\* cited by examiner

*Primary Examiner* — Derrick Holland

(74) *Attorney, Agent, or Firm* — Ryan Liebengood

(57) **CLAIM**

We claim the ornamental design for a cable rail, as shown and described.

**DESCRIPTION**

FIG. 1 is a perspective view of a cable rail showing our design;  
FIG. 2 is an end view thereof;  
FIG. 3 is a rear elevational view thereof;  
FIG. 4 is a front elevational view thereof;  
FIG. 5 is a top plan view thereof; and,  
FIG. 6 is a bottom plan view thereof.  
The broken lines shown represent unclaimed subject matter and form no part of the claimed design.

**1 Claim, 6 Drawing Sheets**

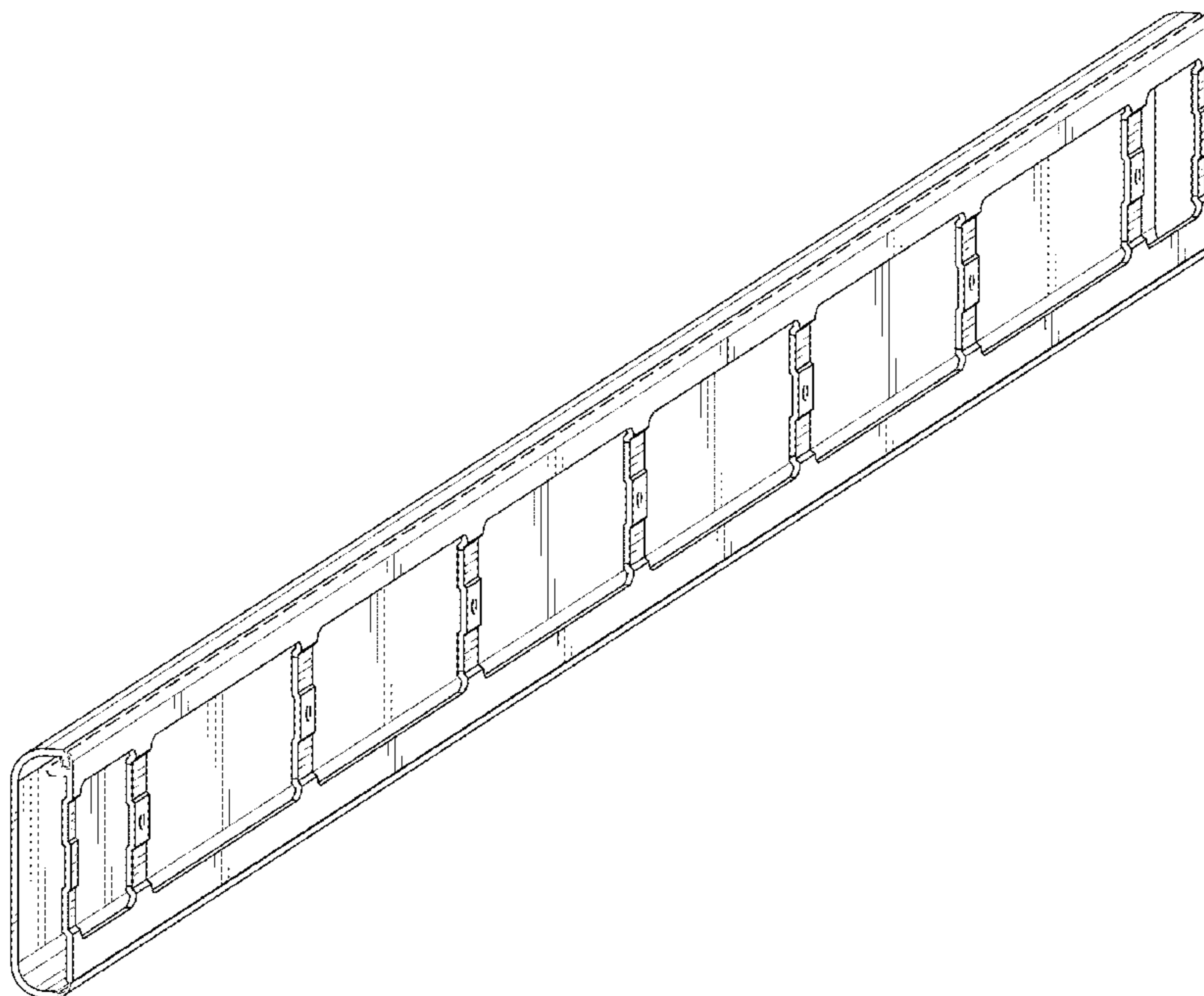

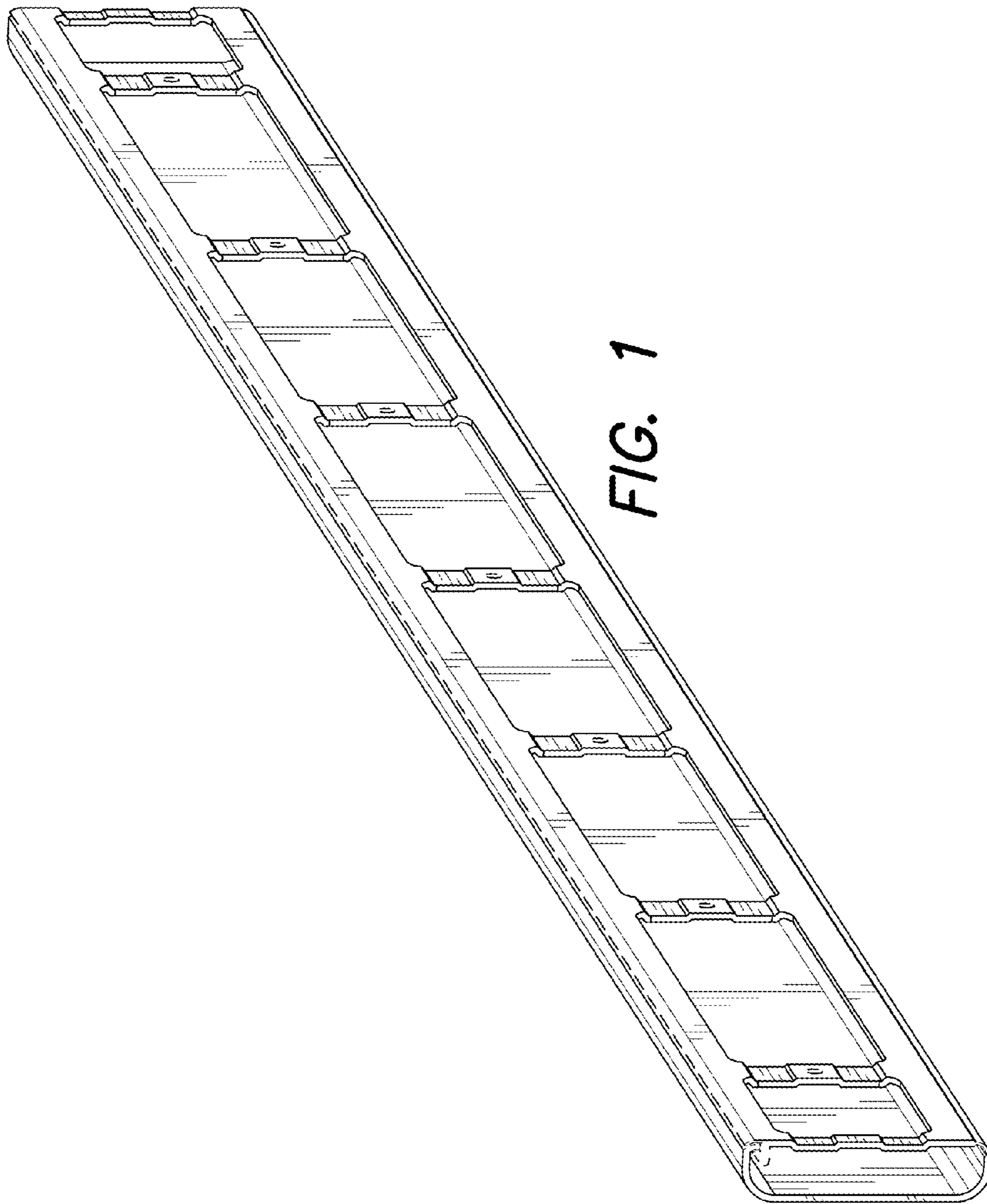

FIG. 1

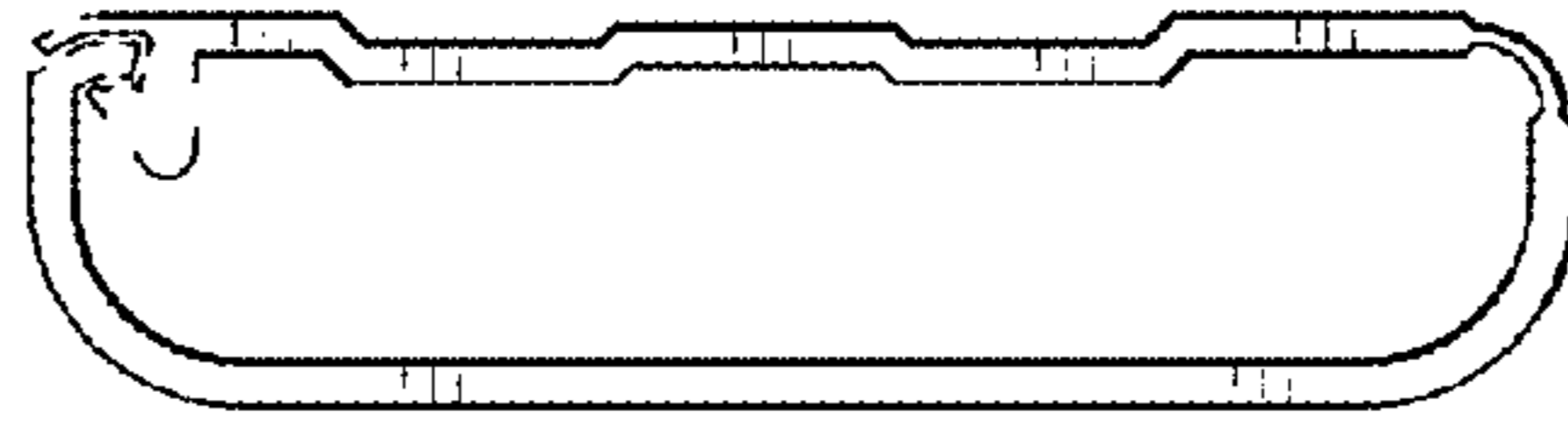

FIG. 2

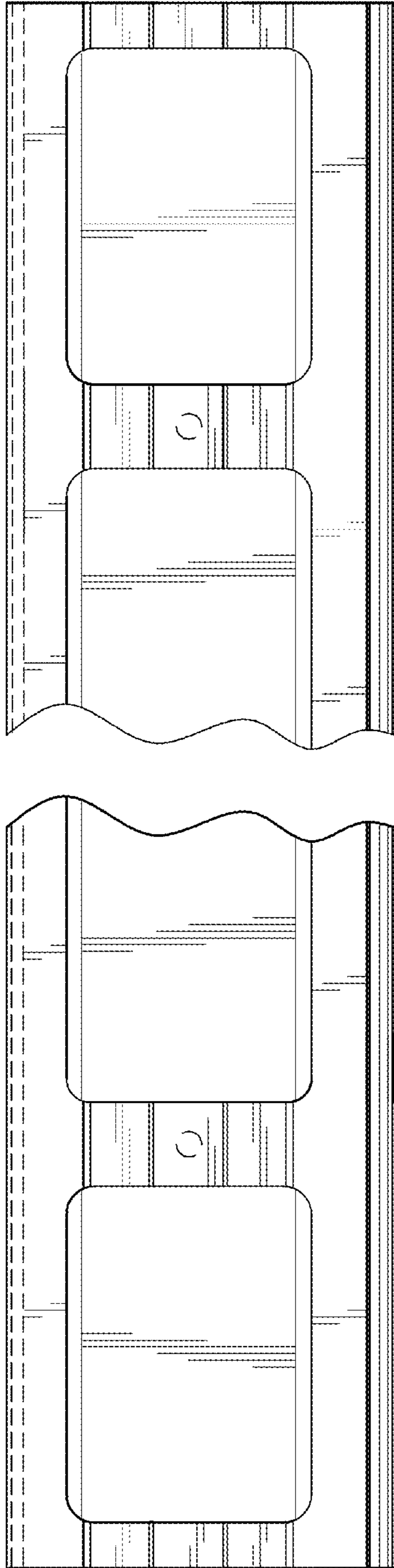

FIG. 3

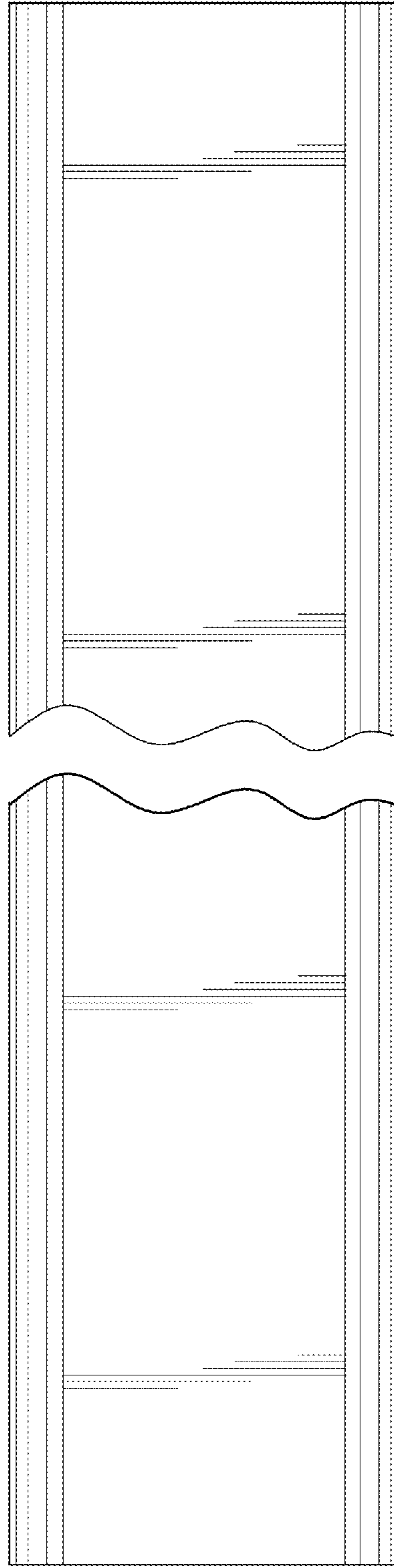
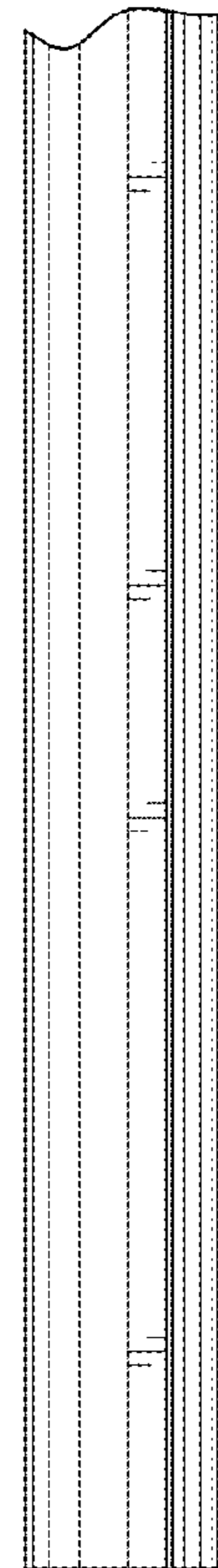
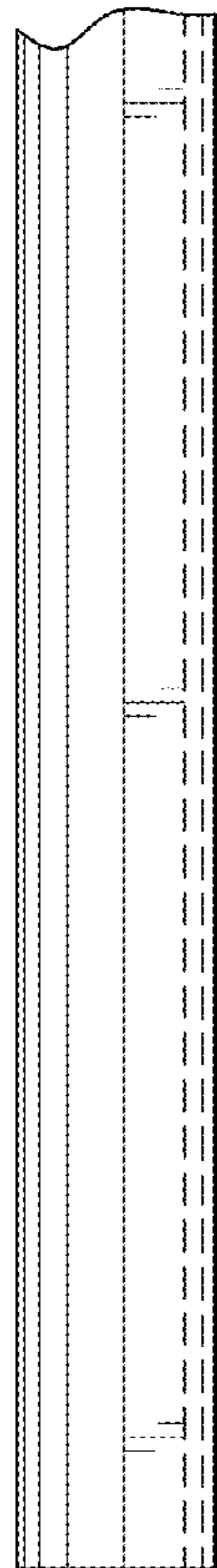
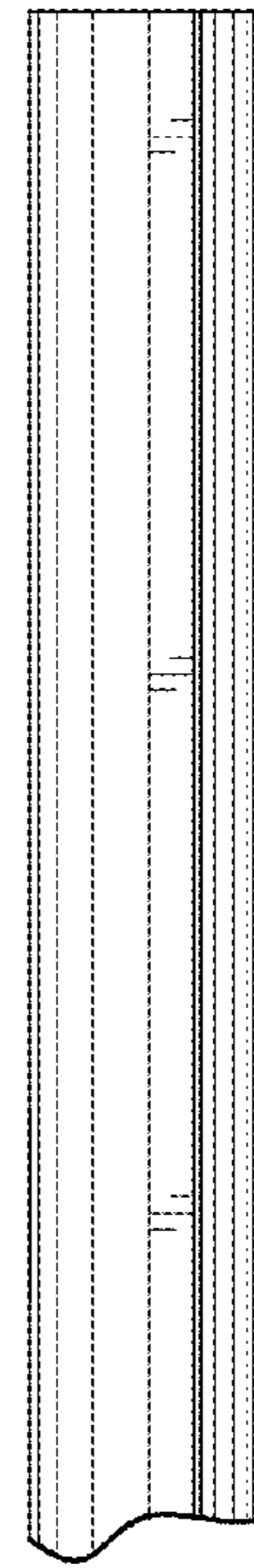
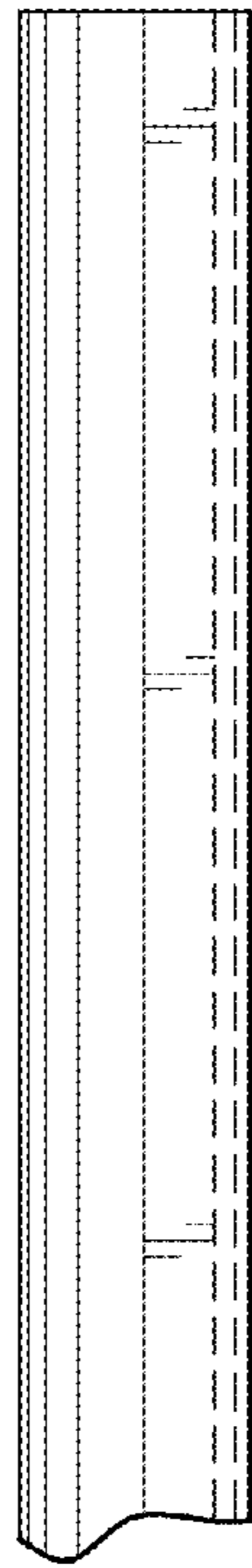
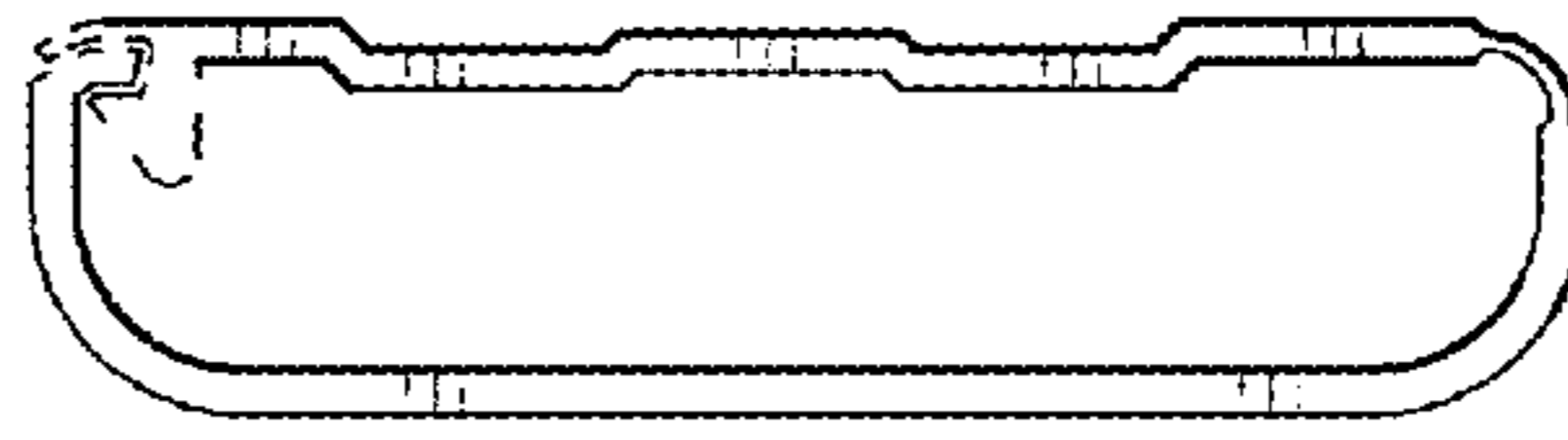
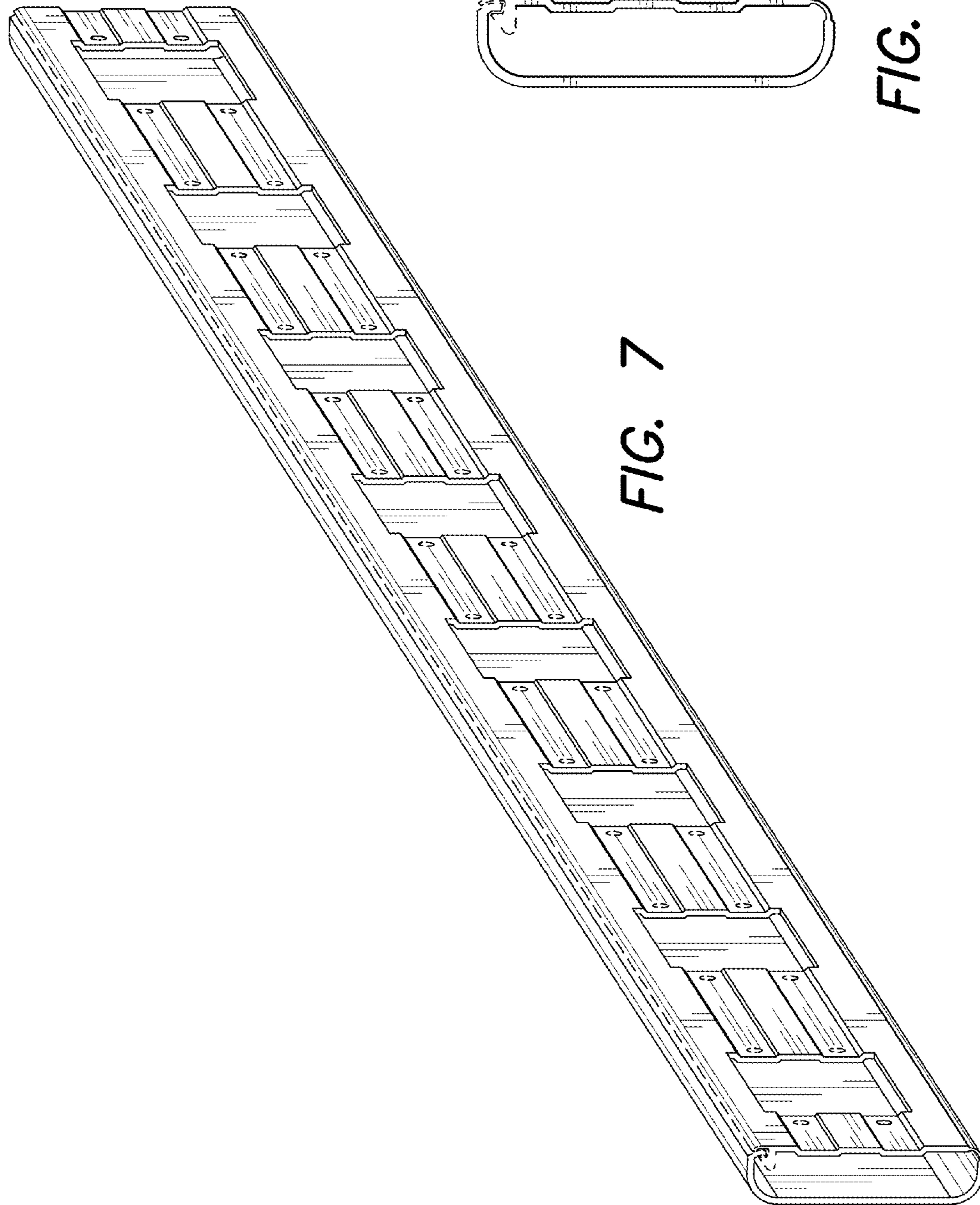

FIG. 4



*FIG. 5*

*FIG. 6*



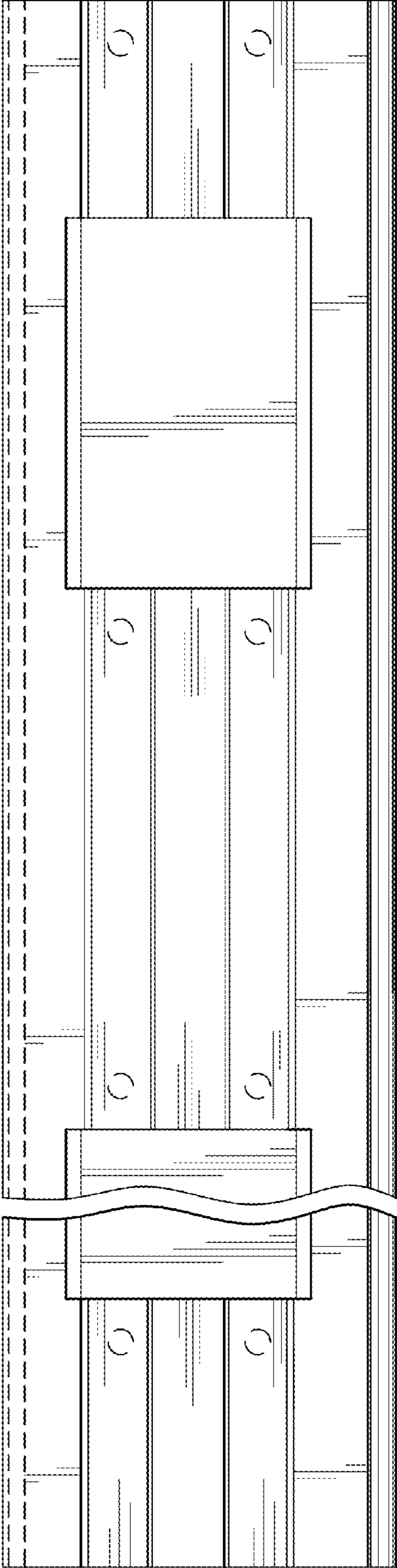

FIG. 9

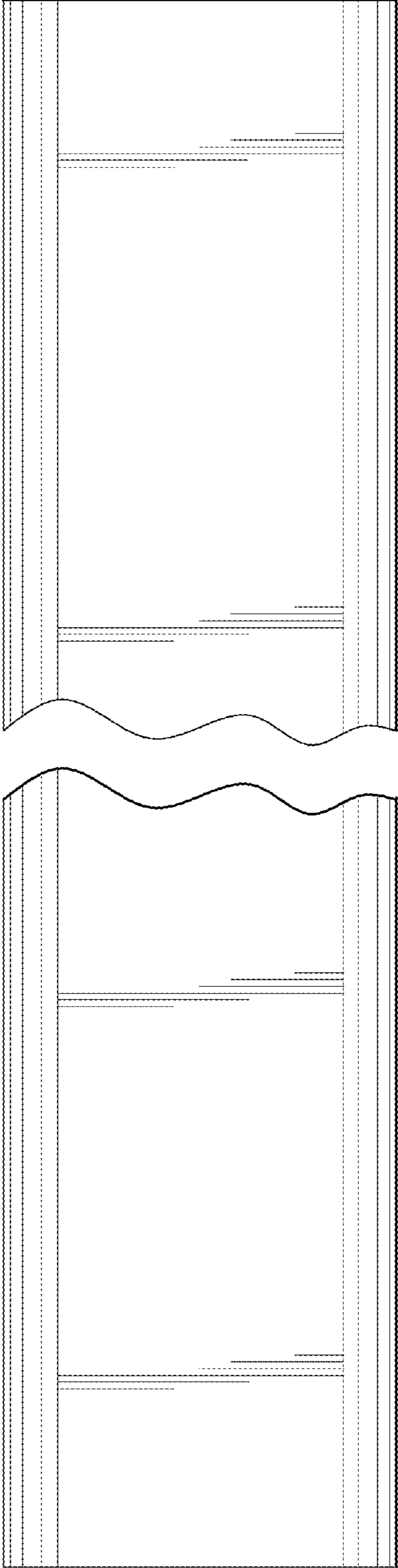
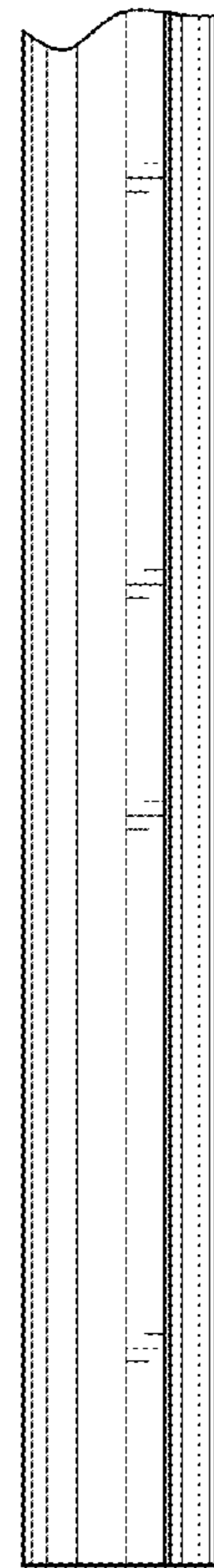
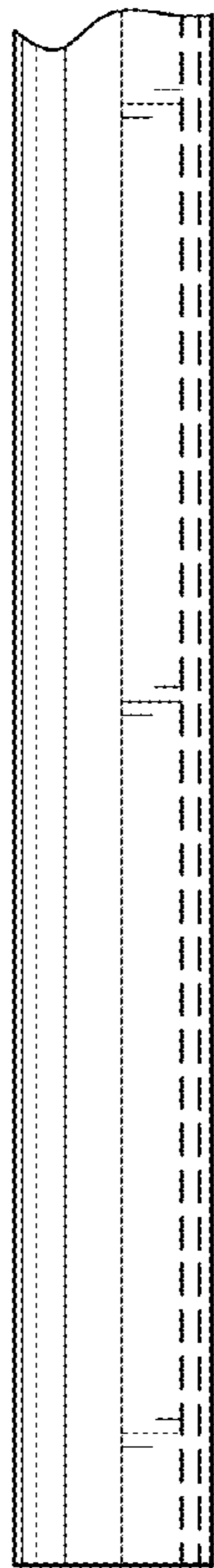
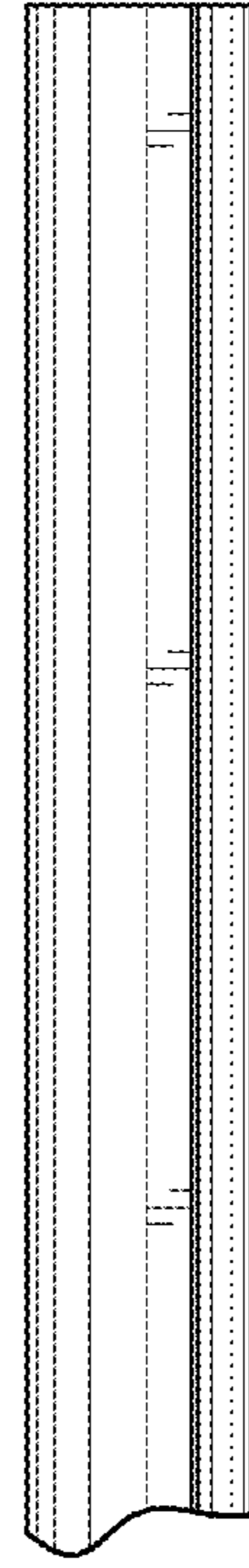
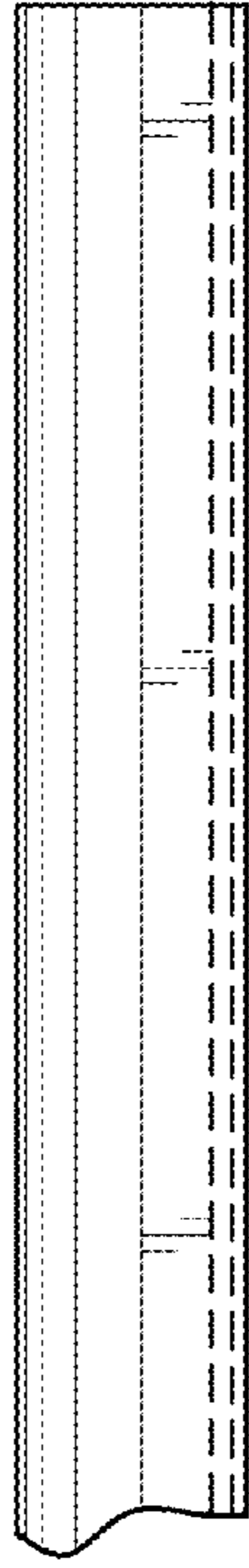

FIG. 10



**FIG. 11**

**FIG. 12**