

US00D733577S

(12) **United States Design Patent**
Hsu

(10) **Patent No.:** **US D733,577 S**
(45) **Date of Patent:** **** Jul. 7, 2015**

(54) **TABLE CLOCK**
(71) Applicant: **Hua Wen Hsu**, Taipei (TW)
(72) Inventor: **Hua Wen Hsu**, Taipei (TW)
(**) Term: **14 Years**
(21) Appl. No.: **29/461,900**
(22) Filed: **Jul. 29, 2013**
(51) **LOC (10) Cl.** **10-01**
(52) **U.S. Cl.**
USPC **D10/22**
(58) **Field of Classification Search**
USPC D10/1-29, 30-39, 122-132
CPC G04B 19/00; G04B 19/04; G04B 19/043;
G04B 19/10; G04B 19/12; G04B 19/28;
G04B 19/20; G04B 19/202; G04B 37/00;
G04B 37/0066; G04C 17/005; G04C 17/0075;
G04C 17/02
See application file for complete search history.

D223,169 S * 3/1972 Wallach D10/23
D279,764 S * 7/1985 Rhoades D10/23
D330,678 S * 11/1992 Prudhomme D10/23
5,896,349 A * 4/1999 Haze 368/228
D422,921 S * 4/2000 Hargrove, III D10/22
6,418,087 B1 * 7/2002 Huang 368/228
D652,743 S * 1/2012 Pilz D10/22
2010/0329084 A1 * 12/2010 Mo 368/285
2012/0115120 A1 * 5/2012 Goolrick 434/304

* cited by examiner

Primary Examiner — Martie K Holtje

(57) **CLAIM**
The ornamental design for a table clock, as shown and described.

DESCRIPTION

FIG. 1 is a perspective view of a table clock showing my new design;
FIG. 2 is a front view thereof;
FIG. 3 is a rear view thereof;
FIG. 4 is a left side view thereof;
FIG. 5 is a right side view thereof;
FIG. 6 is a top view thereof; and,
FIG. 7 is a bottom view thereof.
The structural features depicted by broken lines in FIG. 3 have been shown for the purpose of illustrating portions of the table clock that form no part of the claimed design.

(56) **References Cited**
U.S. PATENT DOCUMENTS
2,266,183 A * 12/1941 Fergusson 368/77
D147,601 S * 9/1947 Stern D10/126
D166,244 S * 3/1952 Davidhazy D10/17
2,635,357 A * 4/1953 Whitlock 434/304

1 Claim, 5 Drawing Sheets

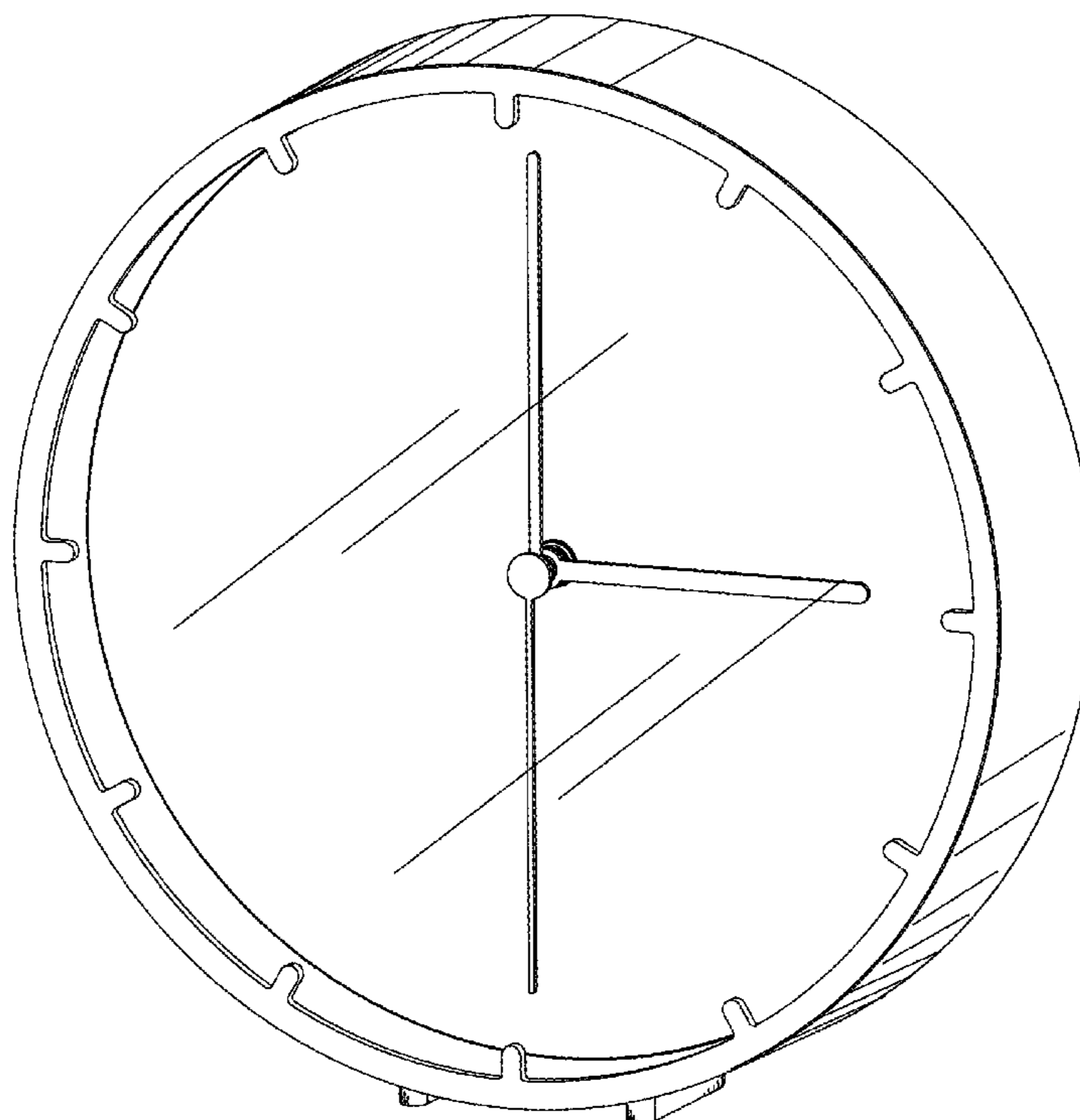

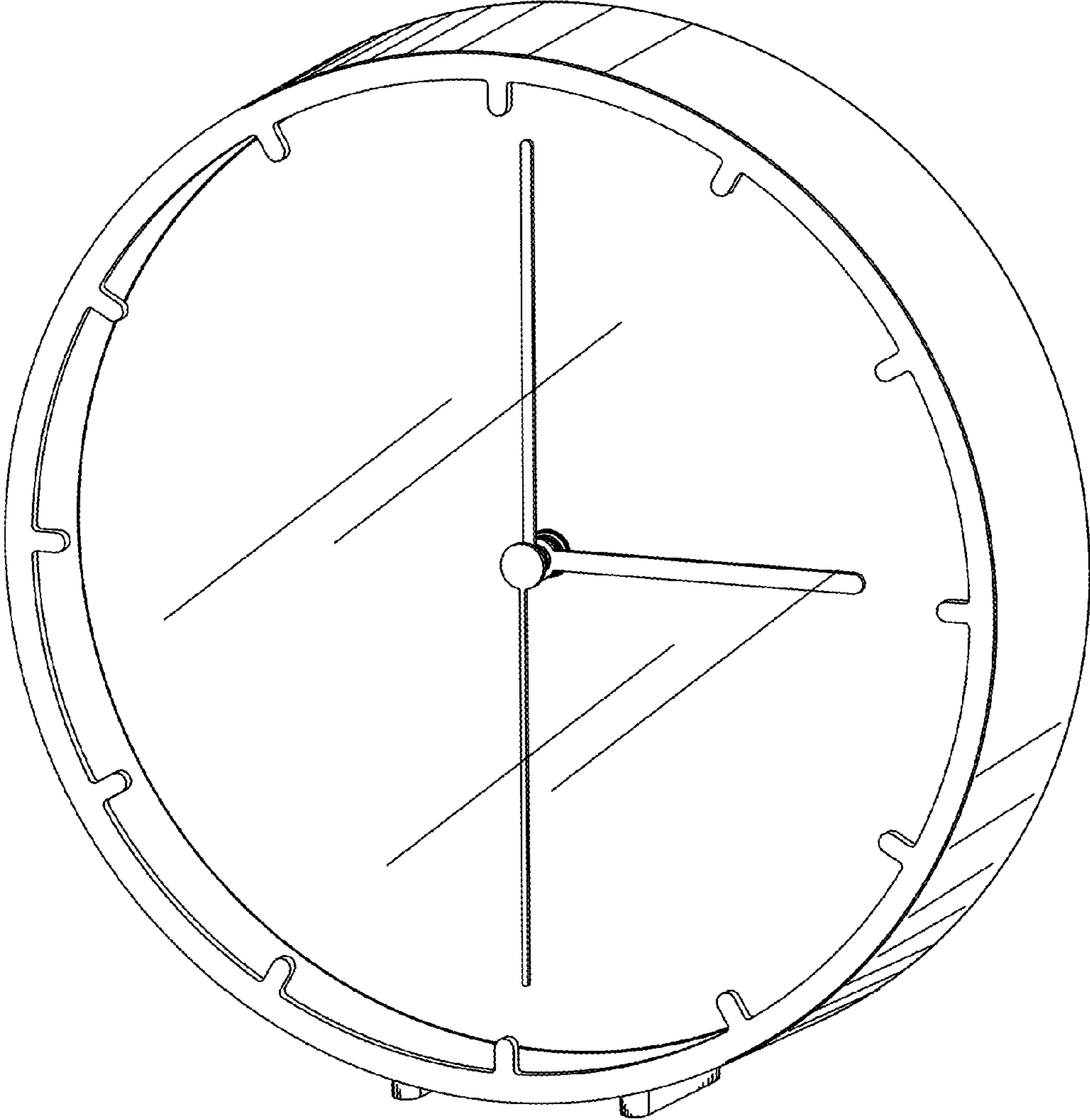

Fig. 1

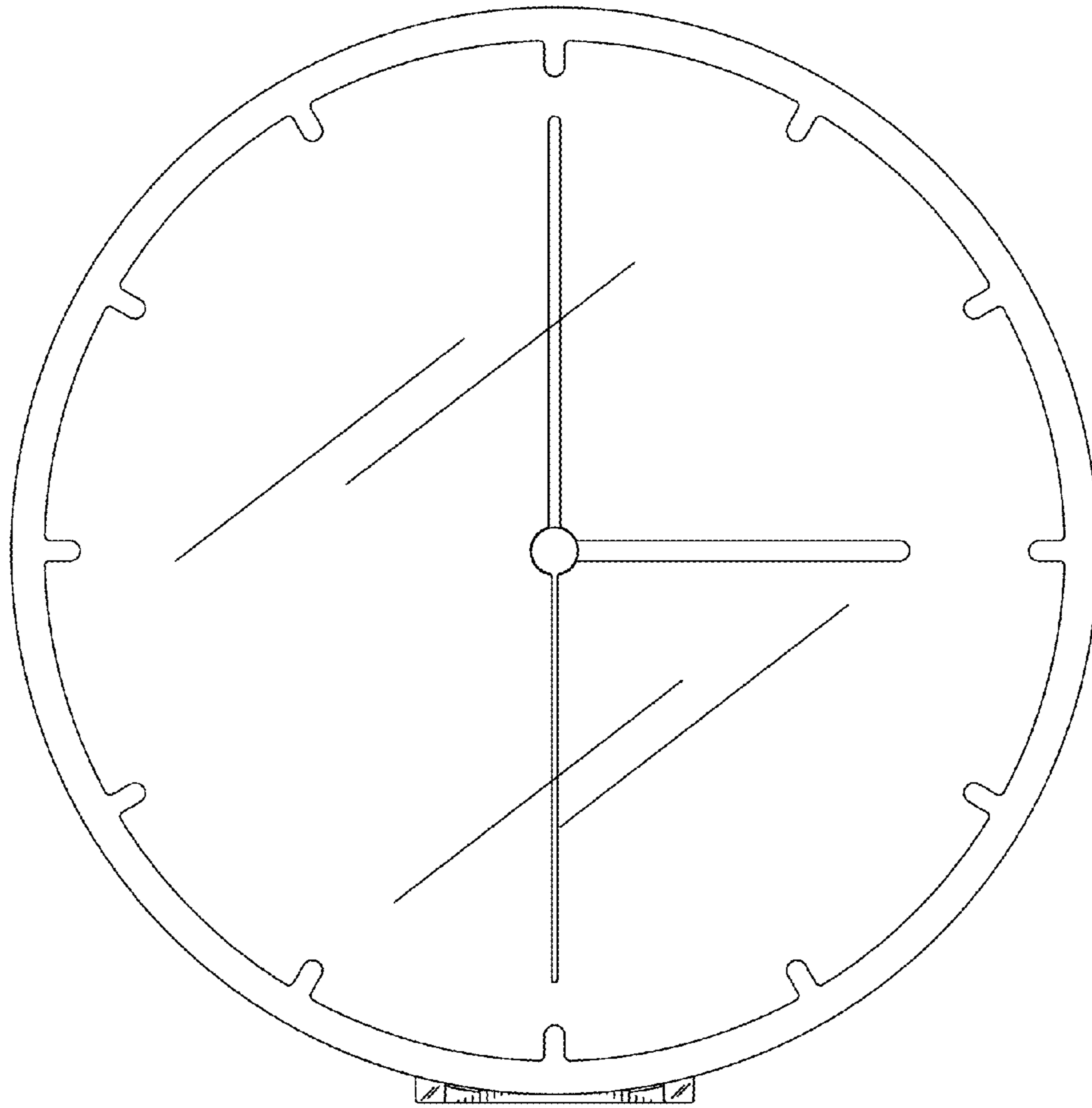

Fig. 2

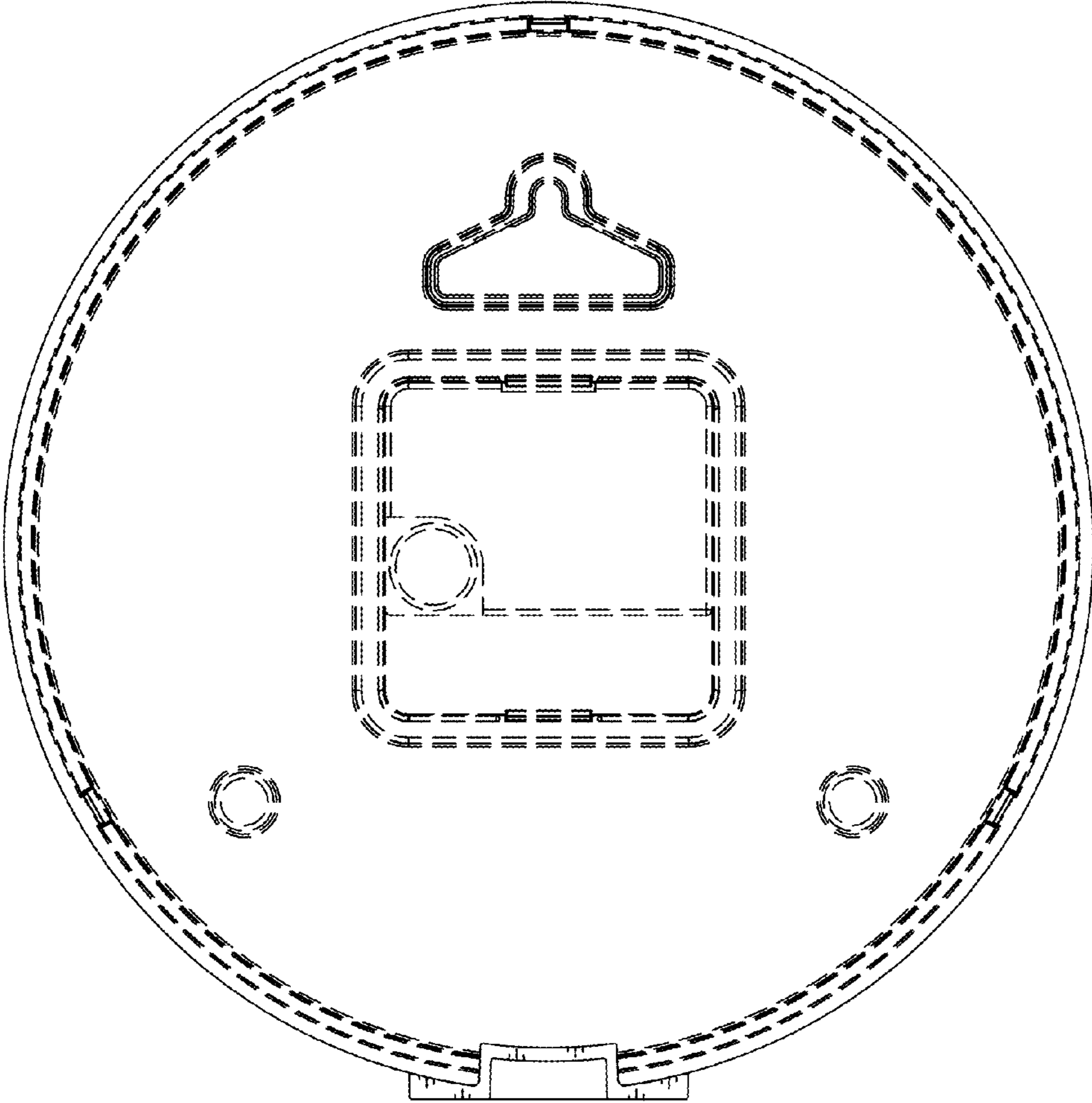

Fig. 3

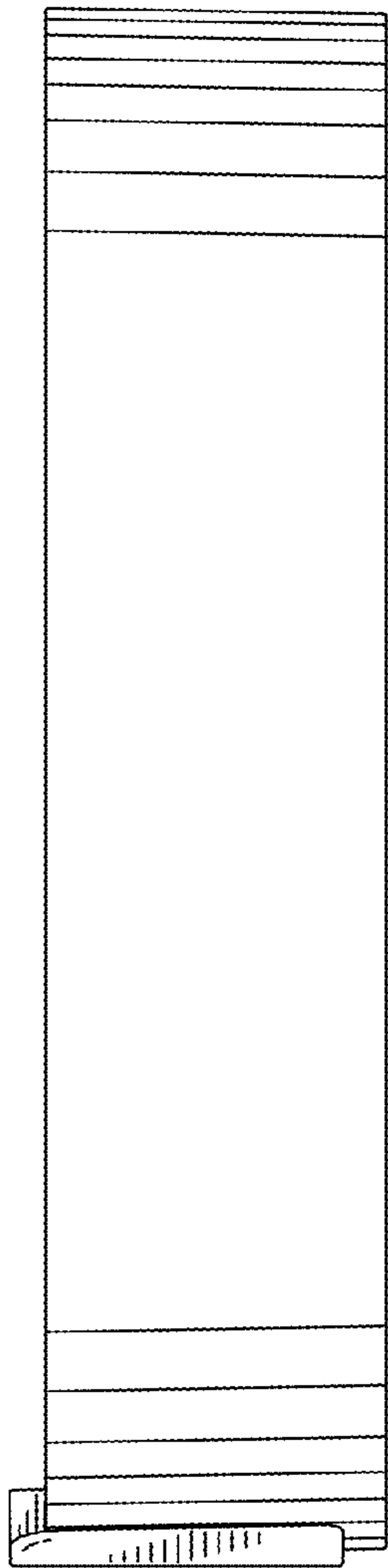

Fig. 4

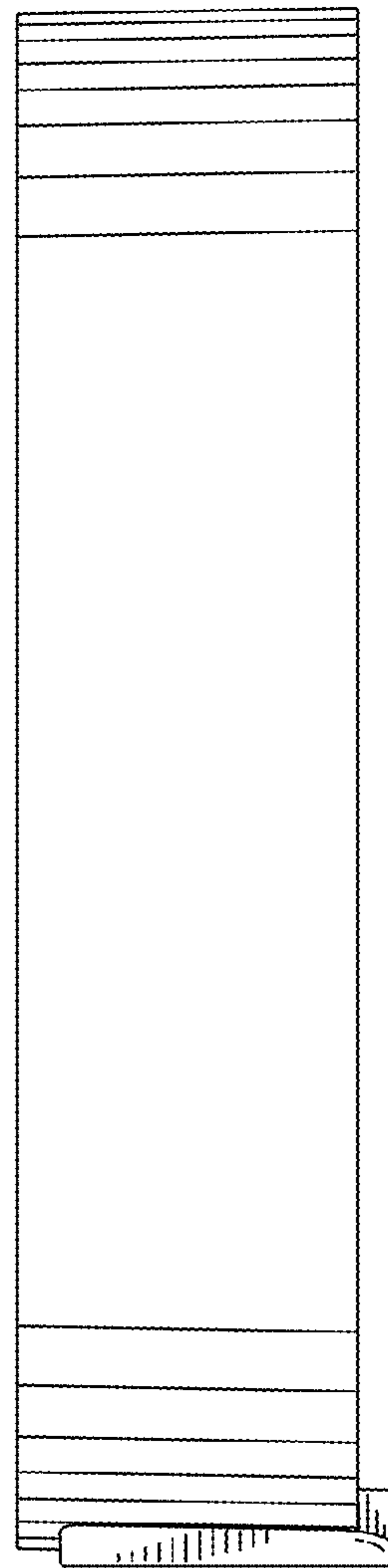

Fig. 5

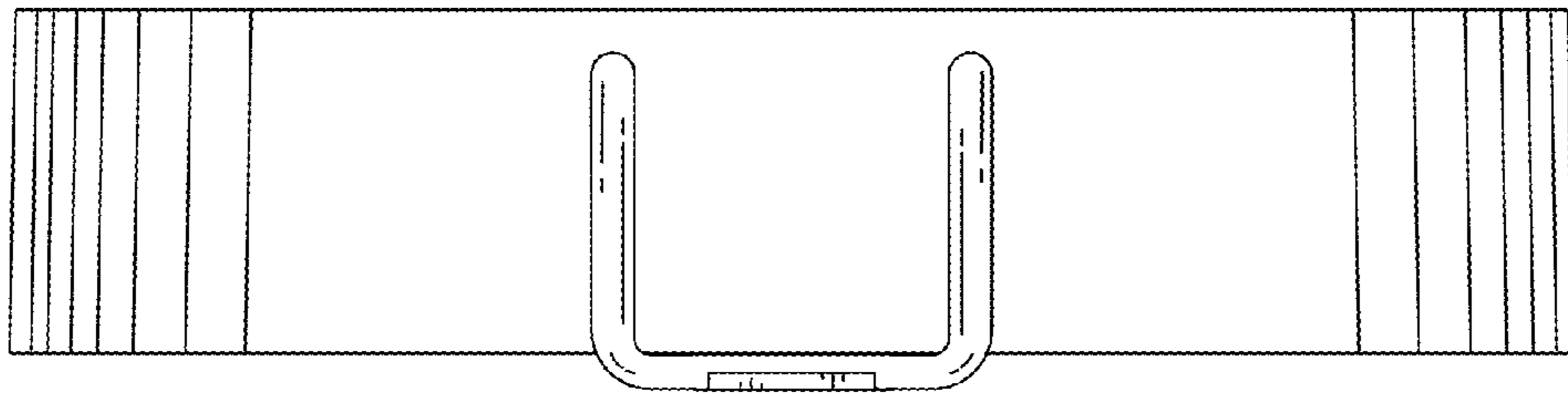

Fig. 6

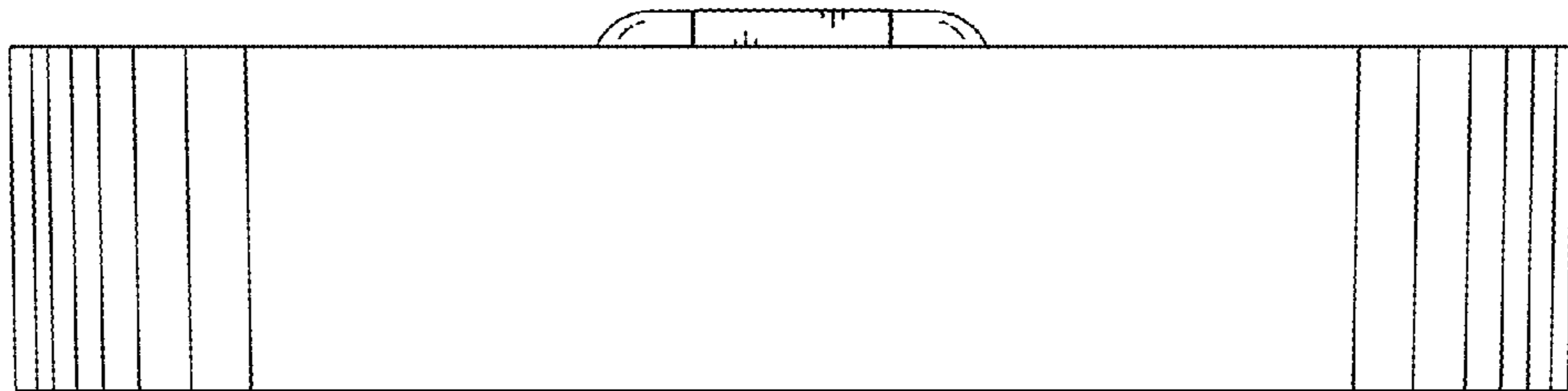

Fig. 7