



US00D733549S

(12) **United States Design Patent**
Sanfilippo et al.

(10) **Patent No.:** **US D733,549 S**
(45) **Date of Patent:** **** Jul. 7, 2015**

(54) **PACKAGE**

- (71) Applicant: **CLEAR LAM PACKAGING, INC.**,
Elk Grove Village, IL (US)
- (72) Inventors: **James J. Sanfilippo**, Barrington Hills,
IL (US); **Milorad Radenovic**, Chicago,
IL (US)
- (73) Assignee: **CLEAR LAM PACKAGING, INC.**,
Elk Grove Village, IL (US)

(**) Term: **14 Years**

(21) Appl. No.: **29/470,913**

(22) Filed: **Oct. 25, 2013**

(51) **LOC (10) Cl.** **09-03**

(52) **U.S. Cl.**
USPC **D9/414**

(58) **Field of Classification Search**
USPC D9/416, 414, 432, 431, 433, 423, 430,
D9/734, 739, 417, 418, 434; 229/123.3,
229/106, 108, 116.1, 207, 200, 201, 210,
229/230, 232, 122; D3/203.2
See application file for complete search history.

(56) **References Cited**

U.S. PATENT DOCUMENTS

2,017,176 A	10/1935	Andrews
2,041,227 A	5/1936	Chalmers
2,048,122 A	7/1936	Howard
2,092,858 A	9/1937	Richard
2,180,841 A	11/1939	Vogt
2,328,579 A	9/1943	Pelosi
2,339,156 A	1/1944	Duane
2,352,766 A	7/1944	Bogue
2,385,898 A	10/1945	Waters

(Continued)

FOREIGN PATENT DOCUMENTS

EP 1106508 A1 6/2001
EP 1508531 A1 2/2005

(Continued)

OTHER PUBLICATIONS

Reynolds, "Doritos Gamer Packs function on multiple levels", Pack-aging World (Nov. 14, 2013).

(Continued)

Primary Examiner — Holly Baynham

Assistant Examiner — Rhea Shields

(74) *Attorney, Agent, or Firm* — Marshall, Gerstein & Borun LLP

(57) **CLAIM**

The ornamental design for a package, as shown and described.

DESCRIPTION

FIG. 1 is a front, back-side, and top isometric view of a package showing a first embodiment of the new design.

FIG. 2 is a top plan view of the package.

FIG. 3 is a front elevation view of the package. The rear elevation is the same except does not include the element shown in broken lines.

FIG. 4 is a side elevation view of the package. The opposite side elevation view is a mirror image of this view.

FIG. 5 is a front, back-side, and top isometric view of a package showing a second embodiment of the new design.

FIG. 6 is a top plan view of the package.

FIG. 7 is a side elevation view of the package. The opposite side elevation view is a mirror image of this view; and,

FIG. 8 is a front elevation view of the package. The rear elevation is the same except does not include the element shown in broken lines.

In the drawings, the broken lines depict unclaimed elements of the package and form no part of the claimed design.

1 Claim, 6 Drawing Sheets

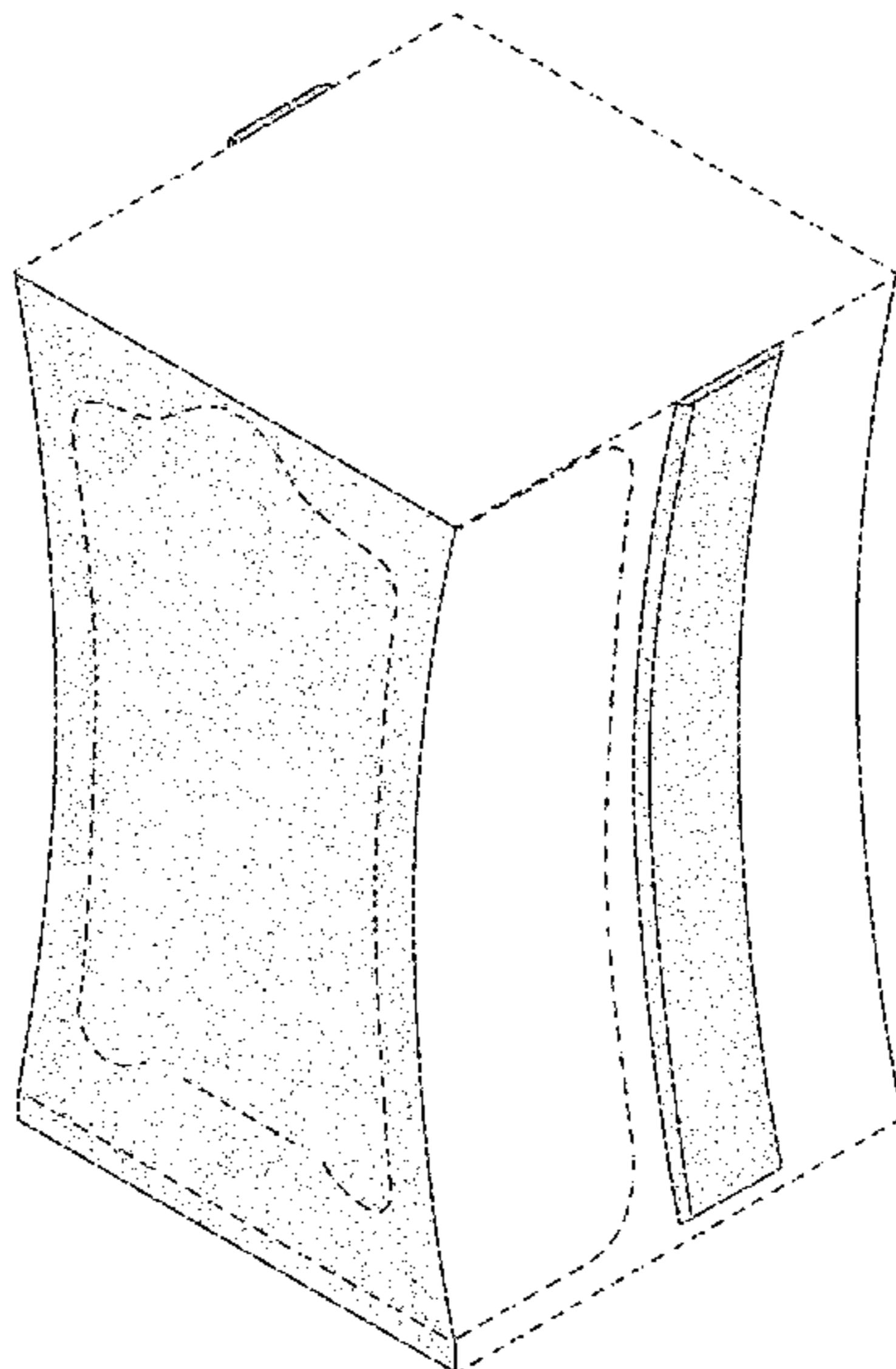

(56)

References Cited

U.S. PATENT DOCUMENTS

2,416,332 A	2/1947	Lehman	5,542,902 A	8/1996	Richison et al.
2,508,962 A	5/1950	Moore	5,556,026 A	9/1996	Blankitny
2,524,766 A	10/1950	Carroll	D374,774 S	10/1996	Cassel
2,619,226 A	11/1952	Adams	5,577,612 A	11/1996	Chesson et al.
2,750,093 A	6/1956	Moore	5,611,452 A	3/1997	Bonora et al.
2,758,775 A	8/1956	Moore	5,613,608 A	3/1997	Tronchetti et al.
2,819,831 A	1/1958	Polarek et al.	5,655,706 A	8/1997	Vandiver
2,936,940 A	5/1960	Berghgracht	D386,001 S	11/1997	Saffran
2,970,735 A	2/1961	Jacke	5,704,480 A	1/1998	Scholz et al.
3,006,257 A	10/1961	Orsini	D394,606 S	5/1998	Zorn et al.
3,127,082 A	3/1964	Meyer-Jagenberg	5,770,839 A	6/1998	Ruebush et al.
3,228,584 A	1/1966	Ashton	5,772,332 A	6/1998	Geller
3,259,303 A	7/1966	Repko	D395,952 S	7/1998	Buczynski et al.
3,314,591 A	4/1967	Cheeley	5,785,179 A	7/1998	Buczynski et al.
3,349,959 A	10/1967	Watkins	5,788,121 A	8/1998	Sasaki et al.
3,373,917 A	3/1968	Cox	5,788,378 A	8/1998	Thomas
3,380,646 A	4/1968	Doyen et al.	5,791,465 A	8/1998	Niki et al.
3,426,499 A	2/1969	Paige	D398,526 S	9/1998	Schwarz et al.
3,434,652 A	3/1969	Shore	D398,844 S	9/1998	Oberloier
3,437,258 A	4/1969	Kugler	5,799,863 A	9/1998	Capy et al.
3,462,067 A	8/1969	Shore	5,826,401 A	10/1998	Bois
3,505,779 A	4/1970	Kopp	5,842,790 A	12/1998	Imer
3,562,392 A	2/1971	Mylus	5,862,652 A	1/1999	Schoeler
3,604,491 A	9/1971	Spiess	D409,484 S	5/1999	Tasker
3,737,095 A *	6/1973	Derauf 229/232	D412,439 S	8/1999	Cormack
3,738,567 A	6/1973	Ruda	6,005,234 A	12/1999	Moseley et al.
3,739,977 A	6/1973	Shapiro et al.	6,021,624 A	2/2000	Richison et al.
3,785,112 A	1/1974	Leasure et al.	6,026,953 A	2/2000	Nakamura et al.
3,917,158 A	11/1975	Dorofachuk et al.	D421,901 S	3/2000	Hill
3,935,993 A	2/1976	Doyen et al.	D421,902 S	3/2000	Hill
3,940,054 A	2/1976	Goebel et al.	6,036,365 A	3/2000	Imer
3,968,921 A	7/1976	Jewell	D427,056 S	6/2000	Irace et al.
3,980,225 A	9/1976	Kan	6,113,271 A	9/2000	Scott et al.
4,041,851 A	8/1977	Jentsch	6,120,183 A	9/2000	Buchanan et al.
4,101,051 A	7/1978	Reil	D431,464 S	10/2000	Collins et al.
4,129,976 A	12/1978	Grundler et al.	6,137,098 A	10/2000	Moseley et al.
4,197,949 A	4/1980	Carlsson	6,149,304 A	11/2000	Hamilton et al.
4,308,679 A	1/1982	Ray, III et al.	D437,686 S	2/2001	Balzar et al.
D265,777 S	8/1982	Elzea et al.	6,182,887 B1	2/2001	Ljunstrom et al.
4,345,393 A	8/1982	Price et al.	6,229,061 B1	5/2001	Dragoo et al.
D266,049 S	9/1982	Conti	6,231,237 B1	5/2001	Geller
4,353,497 A	10/1982	Bustin	6,261,215 B1	7/2001	Imer
4,512,476 A	4/1985	Herrington, Jr.	D446,014 S	8/2001	Adkins
4,531,668 A	7/1985	Forbes, Jr.	6,273,610 B1	8/2001	Koyama et al.
4,576,309 A	3/1986	Tzifkansky et al.	6,274,181 B1	8/2001	Richison et al.
D285,777 S	9/1986	Forbes, Jr.	D447,689 S *	9/2001	Navet et al. D9/430
D286,745 S	11/1986	Forbes, Jr.	D450,960 S	11/2001	Boyea et al.
4,687,104 A	8/1987	Ielmini	D451,385 S *	12/2001	Bryan et al. D9/423
4,738,365 A	4/1988	Prater	D452,374 S	12/2001	Kim
4,746,019 A	5/1988	Prater	6,325,239 B2	12/2001	Randall et al.
D297,214 S	8/1988	Forbes, Jr.	D454,495 S *	3/2002	Bryan et al. D9/433
4,790,436 A	12/1988	Nakamura	D459,652 S *	7/2002	Beutler D9/433
4,798,295 A	1/1989	Rausing	6,423,356 B2	7/2002	Richison et al.
4,837,849 A	6/1989	Erickson et al.	D461,403 S	8/2002	Chomik et al.
4,848,575 A	7/1989	Nakamura et al.	D461,404 S *	8/2002	Steiger D9/430
4,851,246 A	7/1989	Maxwell et al.	D463,276 S	9/2002	Piscopo et al.
D304,016 S	10/1989	Forbes, Jr.	6,446,796 B1	9/2002	Schmidt
D315,099 S	3/1991	Alizard	D464,566 S *	10/2002	Anchor et al. D9/432
5,036,997 A	8/1991	May et al.	D464,884 S	10/2002	Sumpmann et al.
5,044,777 A	9/1991	Watkins et al.	D464,894 S	10/2002	Mittersinker et al.
5,059,036 A	10/1991	Richison et al.	6,481,183 B1	11/2002	Schmidt
5,065,887 A	11/1991	Schuh et al.	D466,807 S	12/2002	Buck et al.
5,158,371 A	10/1992	Moravek	6,510,673 B1	1/2003	Visona' et al.
D332,399 S	1/1993	Neff	6,513,308 B1	2/2003	Meeuwesen et al.
5,195,829 A	3/1993	Watkins et al.	D471,804 S	3/2003	Staples
5,205,651 A	4/1993	Decottignies et al.	D473,461 S	4/2003	Joubert
5,254,073 A	10/1993	Richison et al.	6,615,567 B2	9/2003	Kuhn et al.
D351,090 S	10/1994	Narsutis	6,659,645 B1	12/2003	Schulz
5,353,946 A	10/1994	Behrend	D485,461 S	1/2004	Sams et al.
5,356,069 A	10/1994	Bochet et al.	6,679,034 B2	1/2004	Kohl et al.
5,366,104 A	11/1994	Armstrong	D486,731 S *	2/2004	Meeker et al. D9/416
D354,436 S	1/1995	Krupa	6,695,757 B2	2/2004	Edwards et al.
D364,563 S	11/1995	Miller et al.	D487,192 S	3/2004	Farnham et al.
5,498,080 A	3/1996	Dalea et al.	D489,530 S	5/2004	Lindsay
5,505,305 A	4/1996	Scholz et al.	6,729,112 B2	5/2004	Kuss et al.
			6,736,309 B1	5/2004	Westerman et al.
			6,746,388 B2	6/2004	Edwards et al.
			6,761,279 B1	7/2004	Martin et al.
			6,783,277 B2	8/2004	Edwards et al.

(56)

References Cited

U.S. PATENT DOCUMENTS

6,817,160 B2 11/2004 Schmidt
 D501,134 S 1/2005 Takahashi et al.
 6,845,602 B2 1/2005 Drut
 D502,095 S 2/2005 Tucker et al.
 D503,336 S 3/2005 Tucker et al.
 D504,622 S 5/2005 Takahashi et al.
 6,918,532 B2 7/2005 Sierra-Gomez et al.
 6,953,069 B2 10/2005 Galomb
 D513,870 S 1/2006 Rosine et al.
 D514,439 S 2/2006 Snedden et al.
 D528,010 S 9/2006 Yashima et al.
 D531,894 S 11/2006 Ramirez et al.
 7,153,026 B2 12/2006 Galomb
 D535,187 S * 1/2007 Clark et al. D9/430
 7,156,556 B2 1/2007 Takahashi et al.
 D536,608 S 2/2007 Arkins
 7,213,710 B2 5/2007 Cotert
 D544,762 S 6/2007 Zimmerman
 D545,186 S 6/2007 Liebe et al.
 D548,080 S 8/2007 Brown et al.
 D551,508 S 9/2007 Friedland et al.
 D552,468 S 10/2007 Seum et al.
 7,299,608 B2 11/2007 Kohl et al.
 D568,763 S * 5/2008 Keberlein D9/734
 D569,719 S 5/2008 Ross
 D571,146 S 6/2008 Sanfilippo et al.
 D571,197 S 6/2008 Sanfilippo et al.
 D591,555 S 5/2009 Sanfilippo et al.
 D593,369 S 6/2009 Green et al.
 D604,502 S * 11/2009 Lee et al. D3/203.2
 D608,193 S 1/2010 Sanfilippo et al.
 7,665,629 B2 2/2010 Julius et al.
 7,665,895 B2 2/2010 Takita et al.
 7,780,006 B2 8/2010 Clark, Jr. et al.
 D629,296 S 12/2010 De Muynck
 7,870,994 B2 * 1/2011 Spivey et al. 229/122
 D637,577 S 5/2011 Han et al.
 D639,679 S * 6/2011 Kissner et al. D9/739
 7,993,256 B2 8/2011 Takita et al.
 8,006,833 B2 8/2011 Clark, Jr. et al.
 8,038,349 B2 10/2011 Andersson et al.
 D648,302 S 11/2011 Park et al.
 8,066,137 B2 11/2011 Sanfilippo et al.
 8,132,395 B2 3/2012 Gehring et al.
 8,231,024 B2 7/2012 Sanfilippo et al.
 D668,949 S * 10/2012 Hipperson et al. D9/423
 8,276,353 B2 10/2012 Reaves et al.
 8,308,363 B2 11/2012 Vogt et al.
 D676,014 S 2/2013 Chung
 D682,244 S 5/2013 Park et al.
 D684,853 S * 6/2013 Dagnino D9/417
 D686,181 S 7/2013 Jeong
 D689,767 S 9/2013 Clark et al.
 D689,769 S * 9/2013 Oates et al. D9/434

D696,107 S 12/2013 Kimple et al.
 8,602,242 B2 12/2013 Sanfilippo et al.
 8,602,244 B2 12/2013 Sanfilippo et al.
 D702,117 S * 4/2014 Dagnino D9/417
 D703,036 S * 4/2014 Baumwald et al. D9/418
 2001/0005979 A1 7/2001 Kuss et al.
 2001/0040107 A1 11/2001 Tourre et al.
 2002/0094922 A1 7/2002 Edwards et al.
 2003/0041564 A1 3/2003 Schmidt
 2003/0059130 A1 3/2003 Yoneyama et al.
 2003/0100424 A1 5/2003 Barmore et al.
 2003/0111523 A1 6/2003 Haugan
 2003/0230504 A1 12/2003 Hamming
 2004/0089578 A1 5/2004 Lin
 2004/0099570 A1 5/2004 Cargile
 2004/0185156 A1 9/2004 Garwood
 2004/0188457 A1 9/2004 Galomb
 2004/0226625 A1 11/2004 Galomb
 2004/0232029 A1 11/2004 Cotert
 2004/0251163 A1 12/2004 Conde et al.
 2005/0011906 A1 1/2005 Buck et al.
 2005/0053315 A1 3/2005 Aasen
 2005/0069230 A1 3/2005 Takahashi et al.
 2005/0109827 A1 5/2005 Martin
 2005/0150785 A1 7/2005 Julius et al.
 2005/0189367 A1 9/2005 Chasid et al.
 2005/0208188 A1 9/2005 Garwood
 2005/0276525 A1 12/2005 Hebert et al.
 2006/0076352 A1 4/2006 Peterson et al.
 2006/0283750 A1 12/2006 Villars et al.
 2007/0151887 A1 7/2007 Clark et al.
 2009/0039078 A1 2/2009 Sanfilippo et al.
 2009/0120828 A1 5/2009 Sanfilippo et al.
 2009/0152290 A1 6/2009 Wang et al.
 2010/0113240 A1 5/2010 Takita et al.
 2010/0140129 A1 6/2010 Sanfilippo et al.
 2011/0297690 A1 12/2011 Teys et al.
 2012/0125937 A1 5/2012 Ahlstrom et al.
 2014/0083897 A1 3/2014 Sanfilippo et al.
 2014/0102936 A1 4/2014 Sanfilippo et al.
 2014/0109522 A1 4/2014 Sanfilippo et al.

FOREIGN PATENT DOCUMENTS

FR 2766794 A1 2/1999
 JP 10-203560 8/1998
 WO WO-86/06344 A1 11/1986
 WO WO-00/12407 A1 3/2000
 WO WO-02/085726 A1 10/2002
 WO WO-2004110885 A1 12/2004

OTHER PUBLICATIONS

Color photographs of Frito-Lay Doritos "Gamer Pack" package (circa 2013).

* cited by examiner

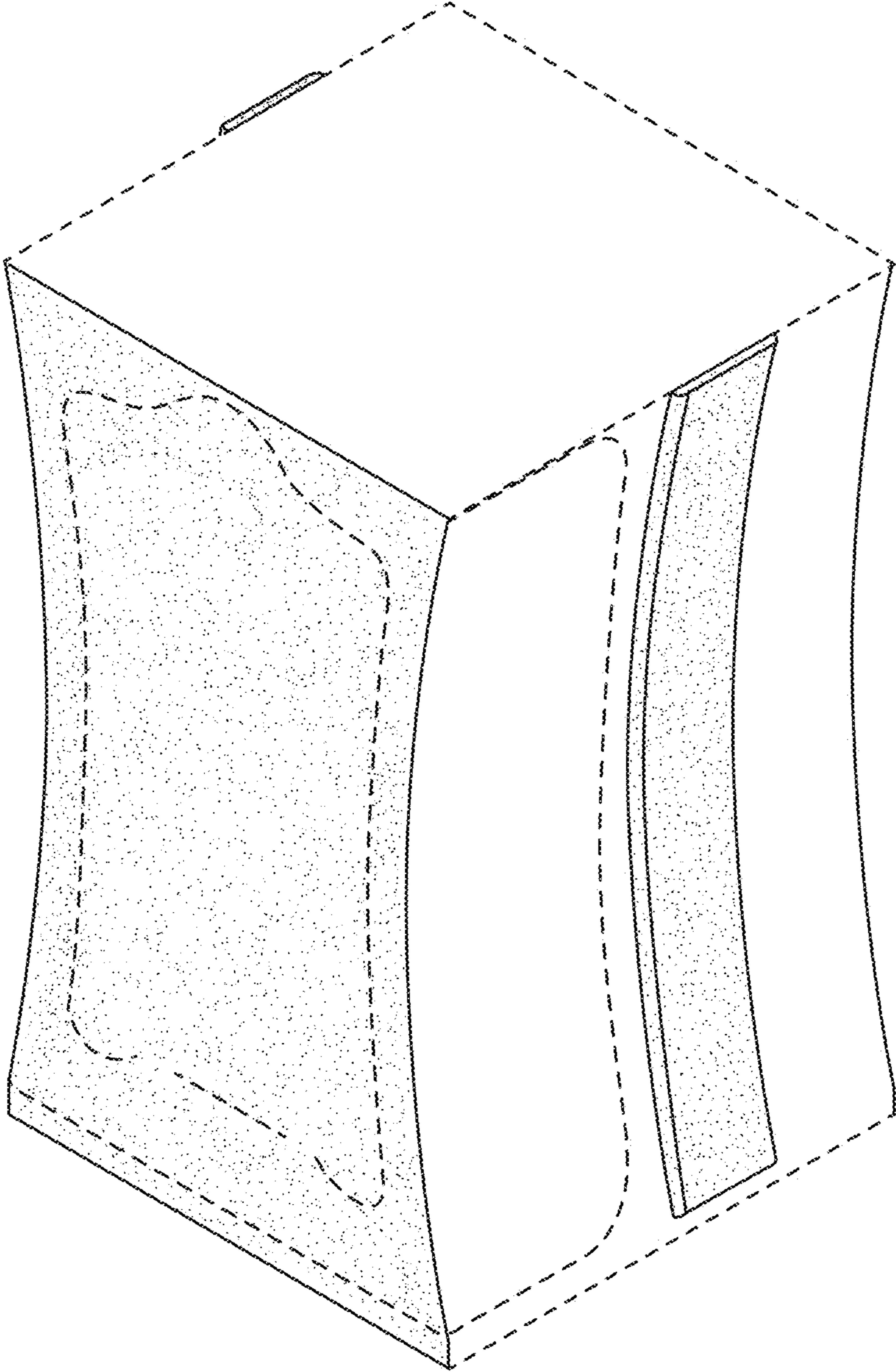

FIG. 1

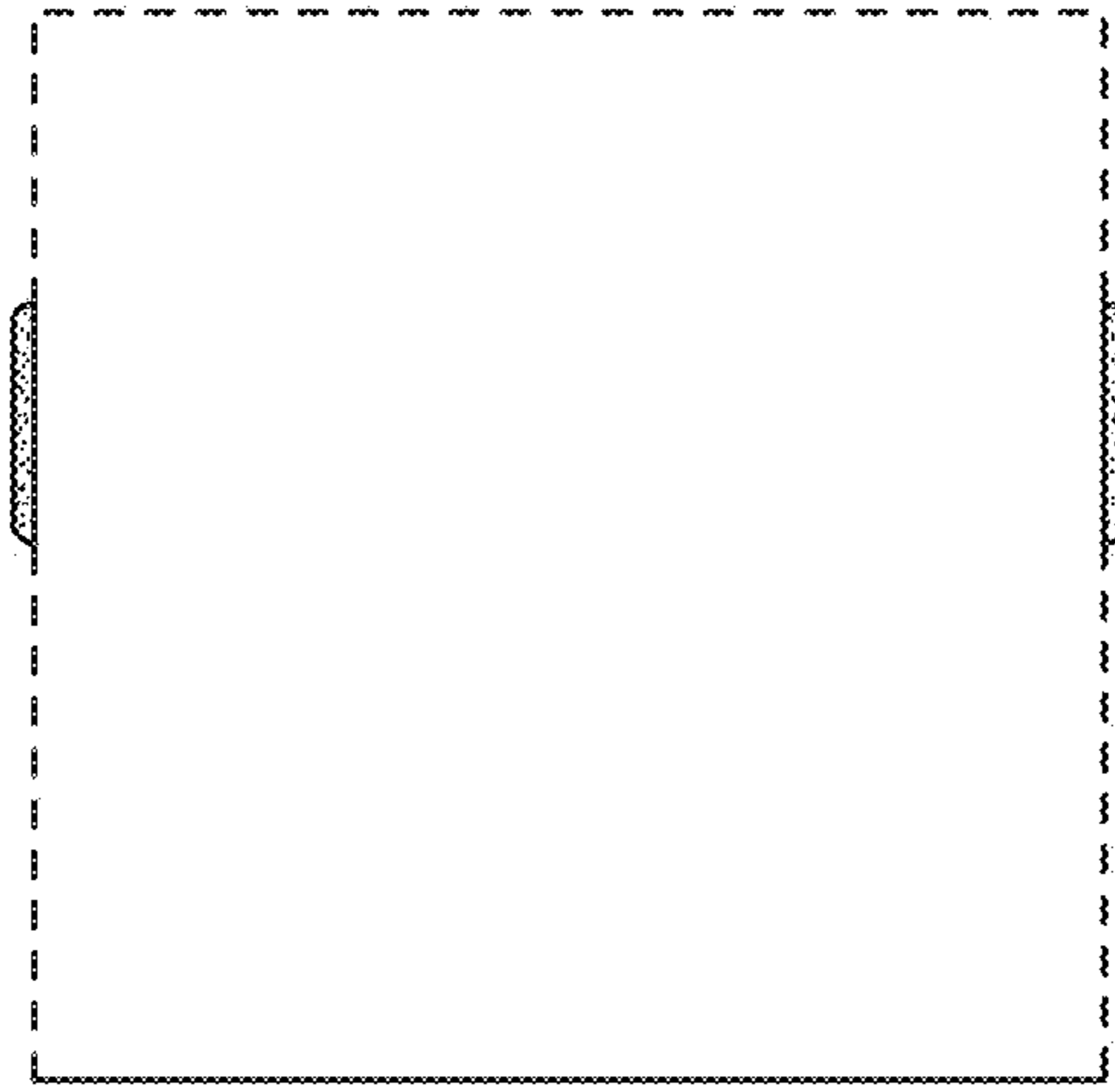

FIG. 2

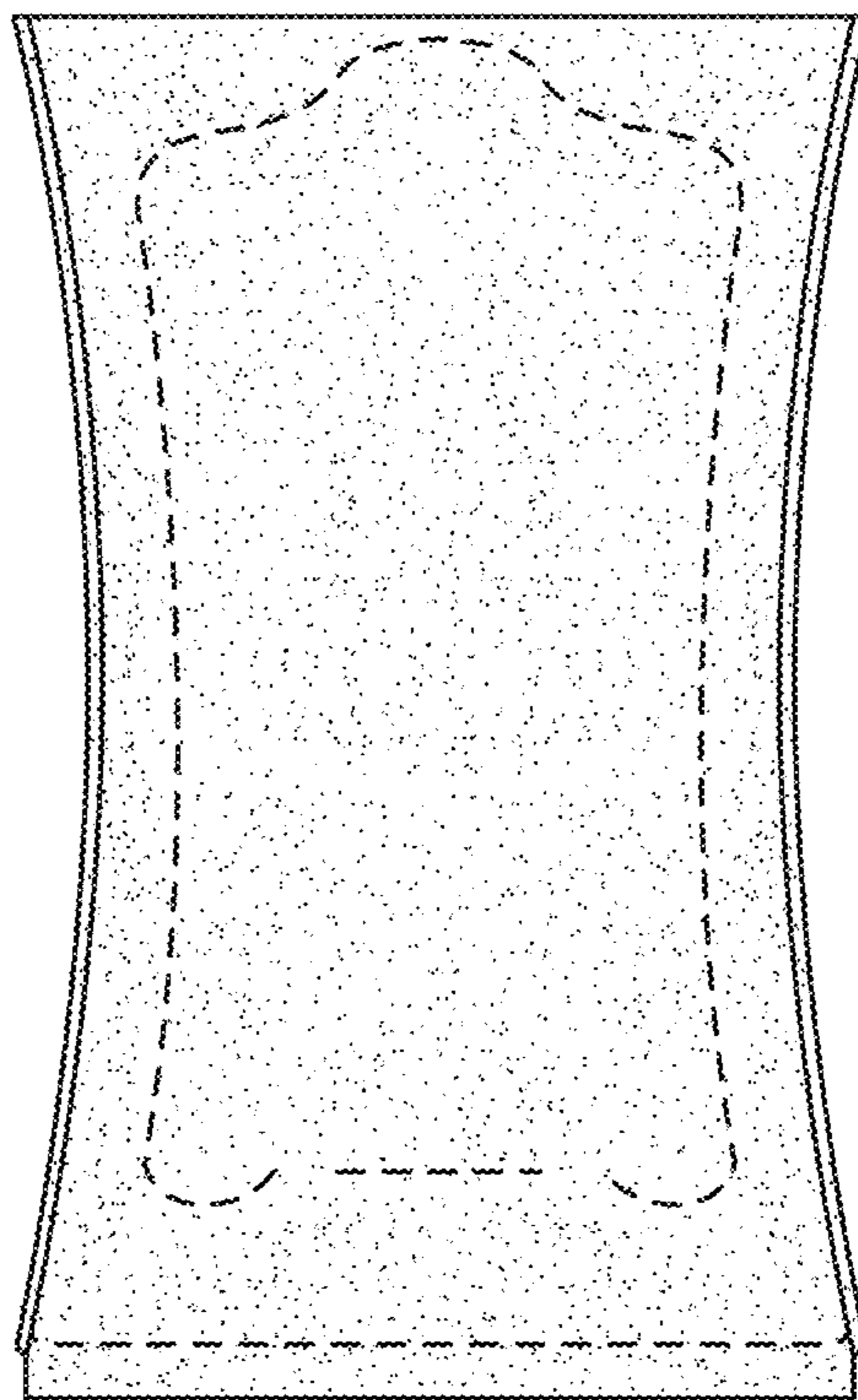

FIG. 3

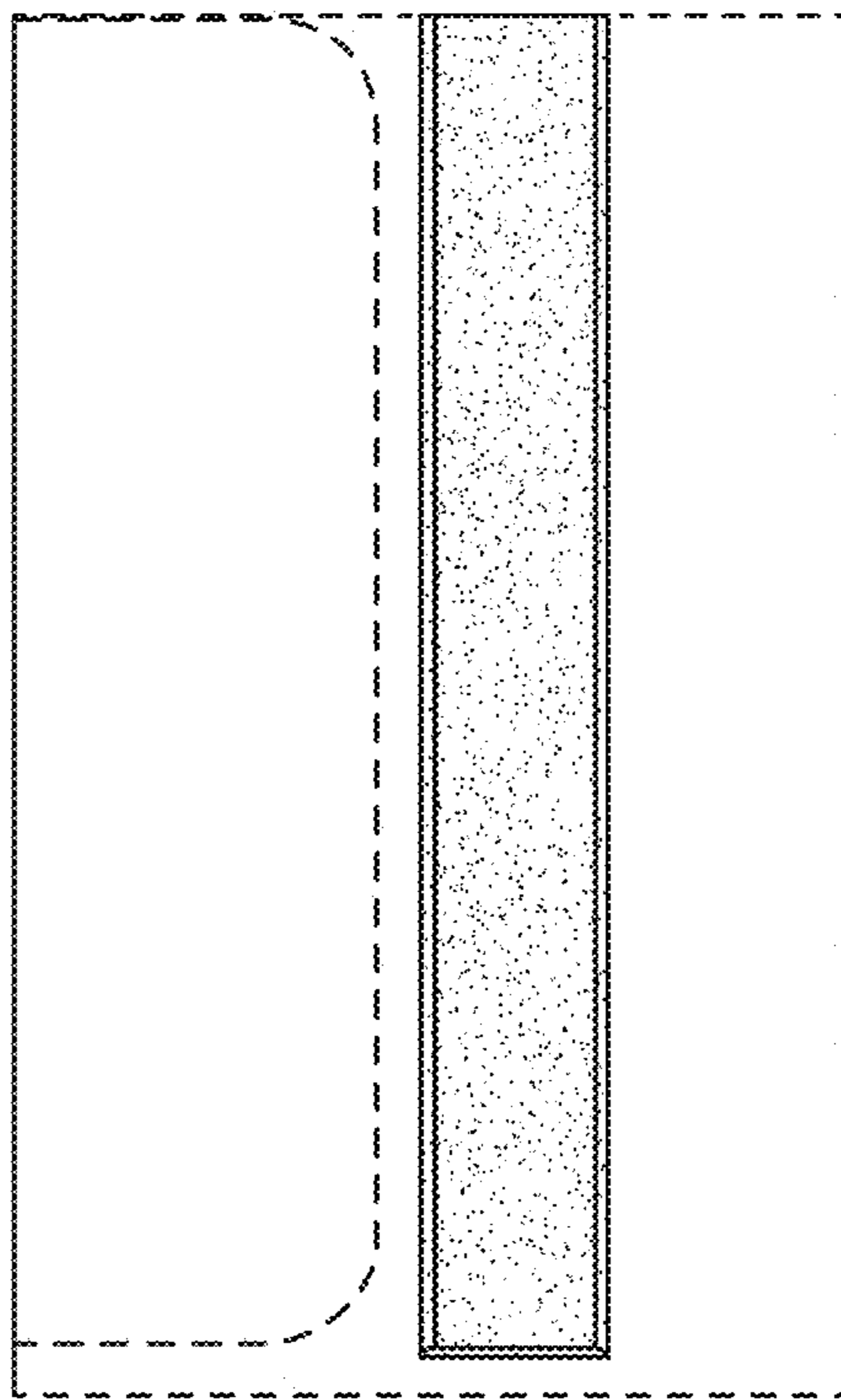

FIG. 4

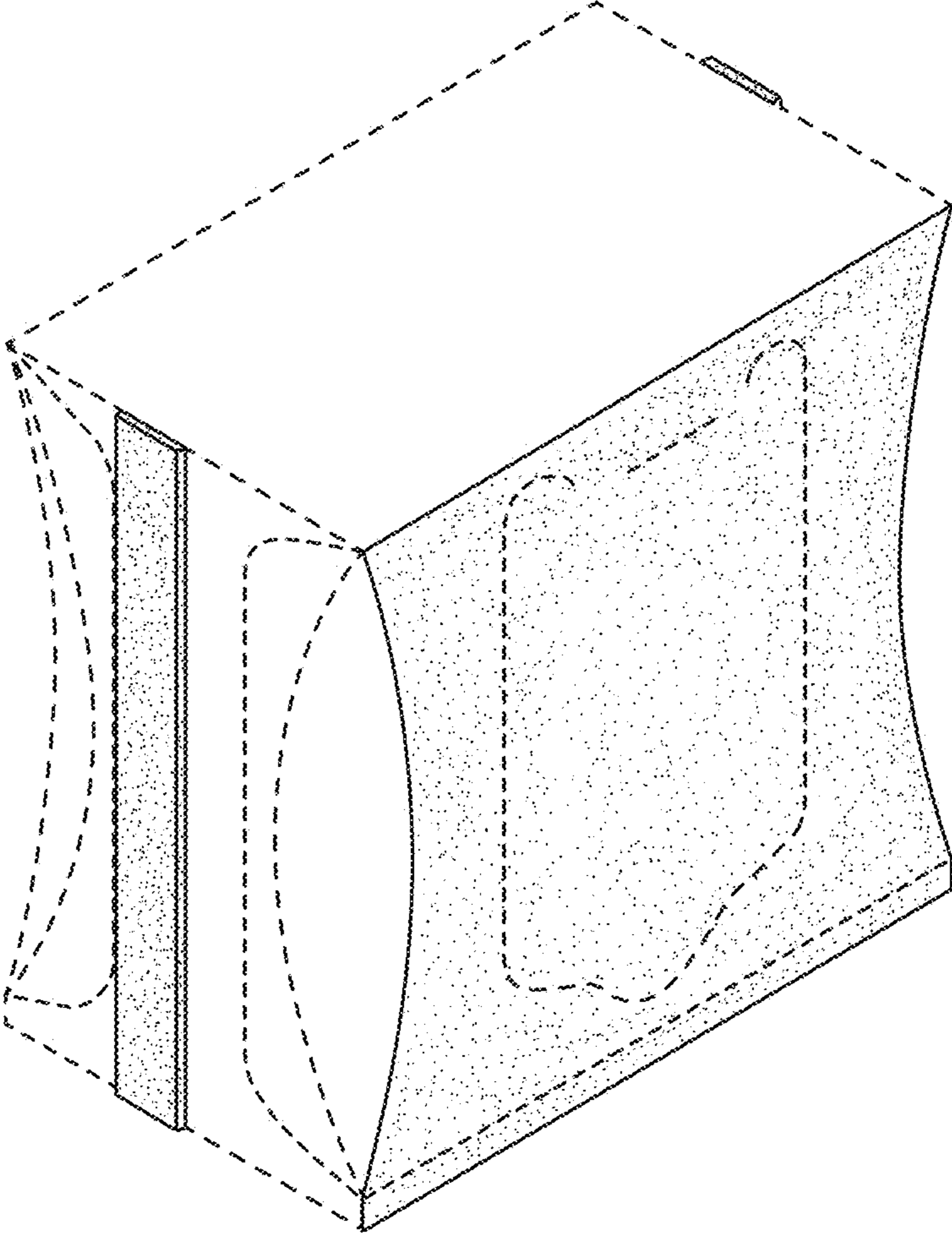

FIG. 5

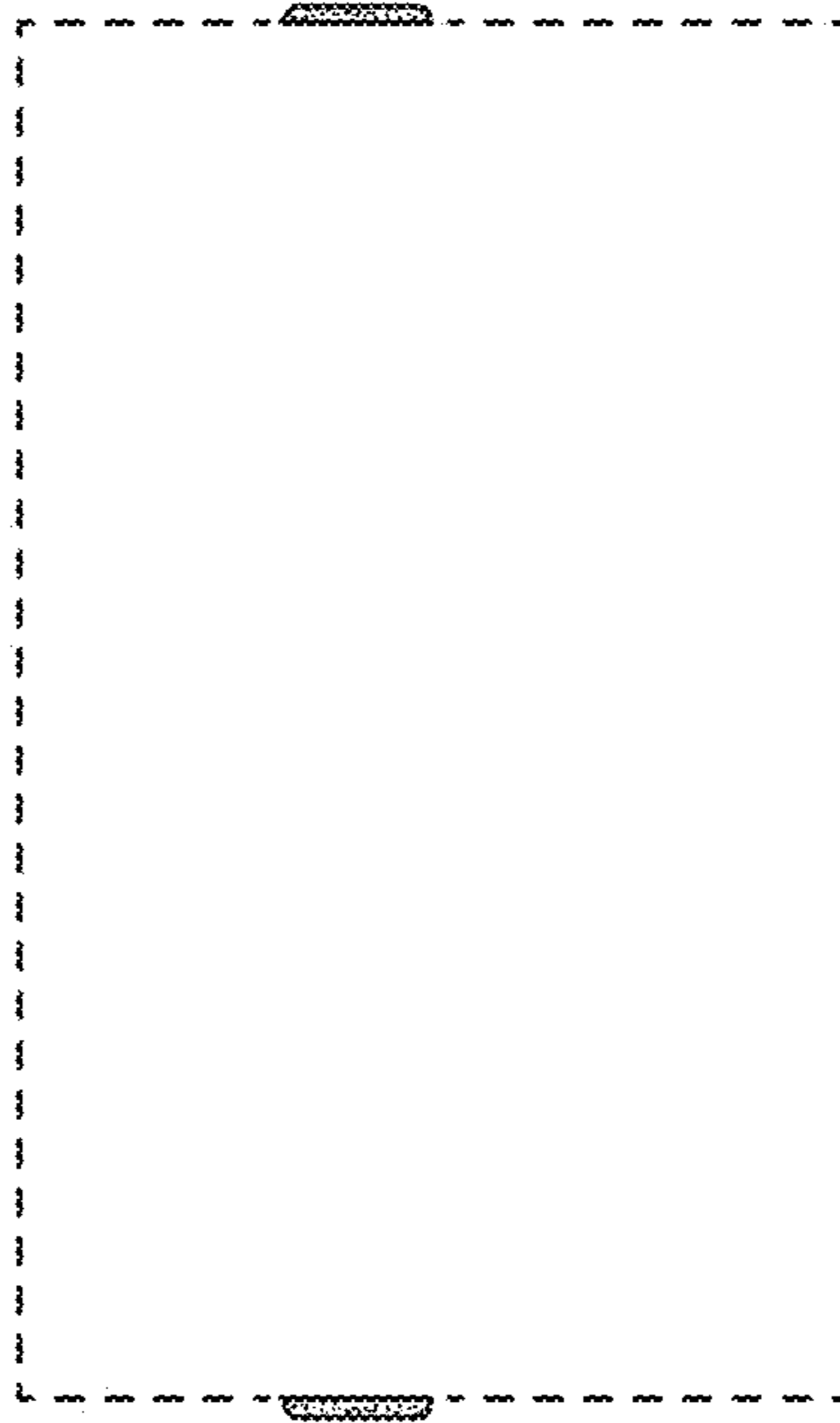

FIG. 6

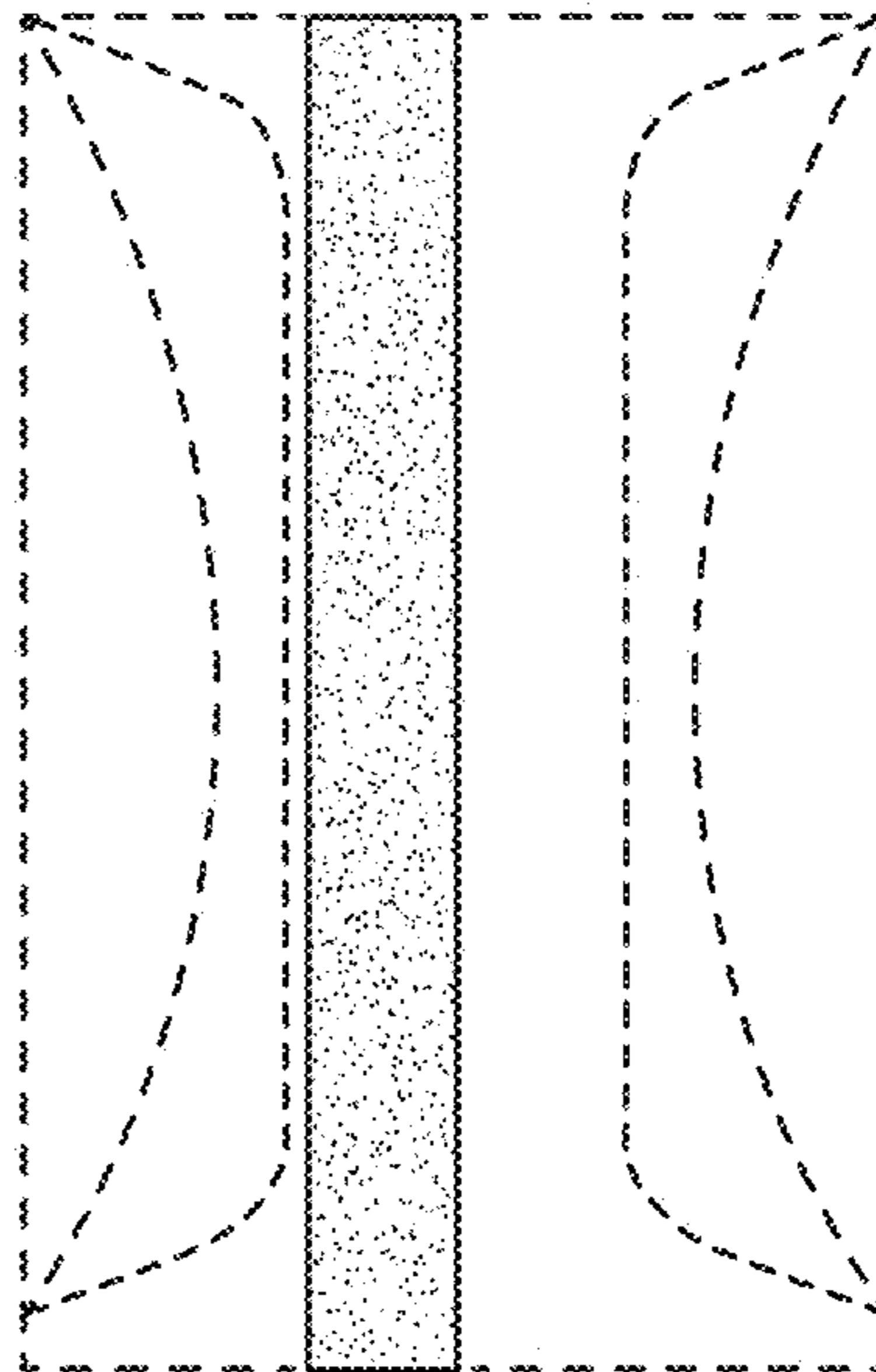

FIG. 7

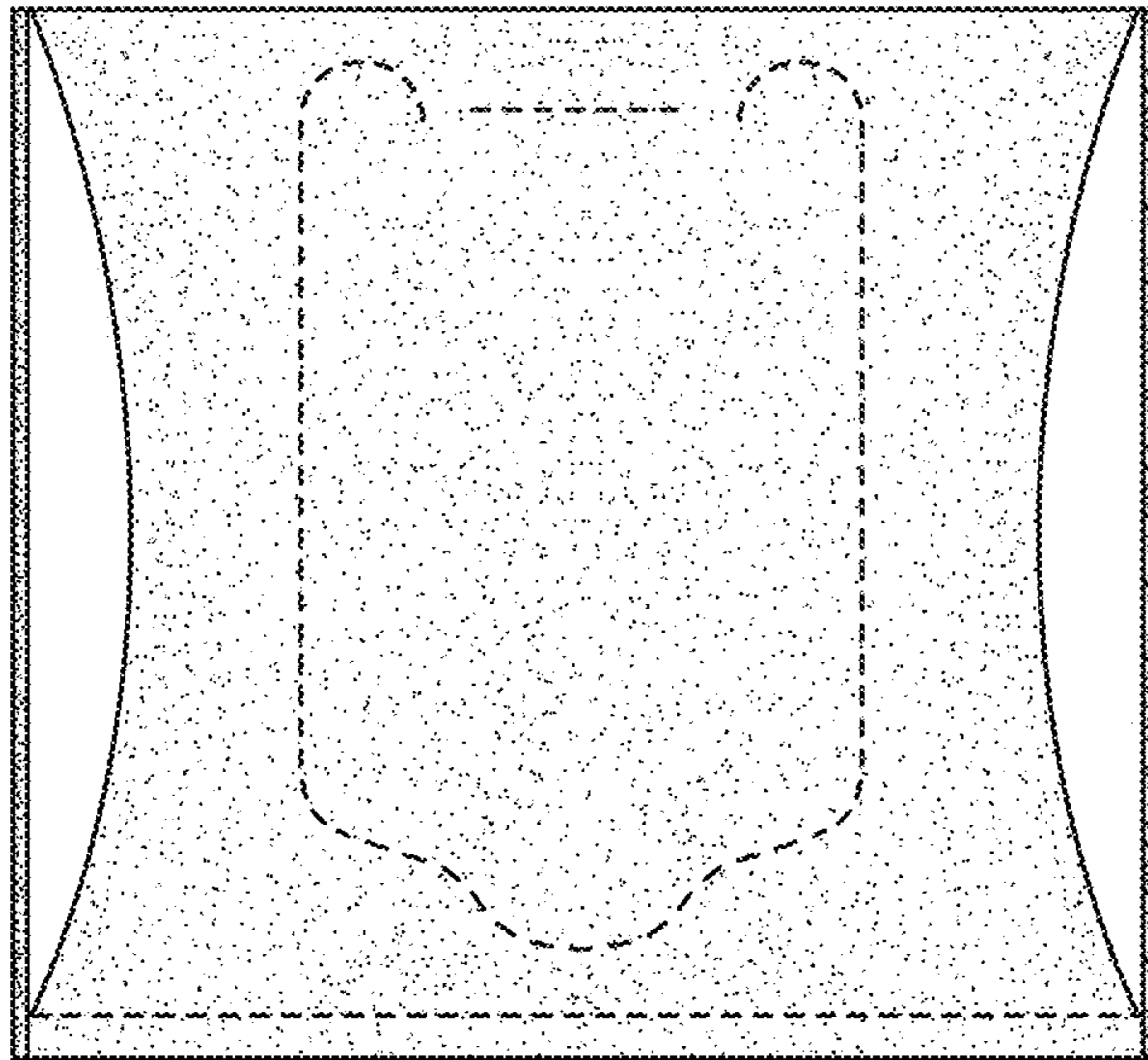

FIG. 8