



US00D733485S

(12) **United States Design Patent**
Zhou et al.

(10) **Patent No.:** **US D733,485 S**

(45) **Date of Patent:** **** Jul. 7, 2015**

(54) **MICROWAVE OVEN**

(56) **References Cited**

(71) Applicants: **GUANGDONG MIDEA KITCHEN APPLIANCES MANUFACTURING CO., LTD**, Foshan (CN); **MIDEA GROUP CO., LTD**, Foshan (CN)

U.S. PATENT DOCUMENTS

D442,018 S *	5/2001	Kusachi et al.	D7/351
D521,309 S *	5/2006	Carlini	D7/350.1
D607,264 S *	1/2010	Lee	D7/351
D615,803 S *	5/2010	Sindeaux et al.	D7/351
D618,488 S *	6/2010	Knochner	D7/350.1
D634,967 S *	3/2011	Drummond et al.	D7/351
D634,968 S *	3/2011	Drummond et al.	D7/351
D638,250 S *	5/2011	Lee et al.	D7/351
D654,299 S *	2/2012	Benold	D7/350.1
D673,001 S *	12/2012	Becze et al.	D7/351
D692,267 S *	10/2013	Busalt et al.	D7/351

(72) Inventors: **Liangsheng Zhou**, Foshan (CN); **Jianfeng Tong**, Foshan (CN); **Shiyong Liu**, Foshan (CN)

(73) Assignees: **GUANGDONG MIDEA KITCHEN APPLIANCES MANUFACTURING CO., LTD**, Foshan (CN); **MIDEA GROUP CO., LTD**, Foshan (CN)

* cited by examiner

Primary Examiner — Ruth McInroy

(**) Term: **14 Years**

(74) *Attorney, Agent, or Firm* — Hamre, Schumann, Mueller & Larson, P.C.

(21) Appl. No.: **29/469,715**

(57) **CLAIM**

The ornamental design for a “microwave oven,” as shown and described.

(22) Filed: **Oct. 14, 2013**

DESCRIPTION

(30) **Foreign Application Priority Data**

Apr. 12, 2013 (CN) 2013 3 0111105

(51) **LOC (10) Cl.** **07-02**

(52) **U.S. Cl.**
USPC **D7/351**

(58) **Field of Classification Search**
USPC D7/350.1–350.4, 351, 402, 405, 406;
126/19 R, 19 M, 41 R; 219/391, 725,
219/756–758; 99/DIG. 14

FIG. 1 is a front, top and right side perspective view of a card reader showing our new design;
FIG. 2 is a front elevational view thereof;
FIG. 3 is a rear elevational view thereof;
FIG. 4 is a left side elevational view thereof;
FIG. 5 is a right side elevational view thereof;
FIG. 6 is a top plan view thereof; and,
FIG. 7 is a bottom plan view thereof.
The details shown in broken lines form no part of the claimed design.

See application file for complete search history.

1 Claim, 6 Drawing Sheets

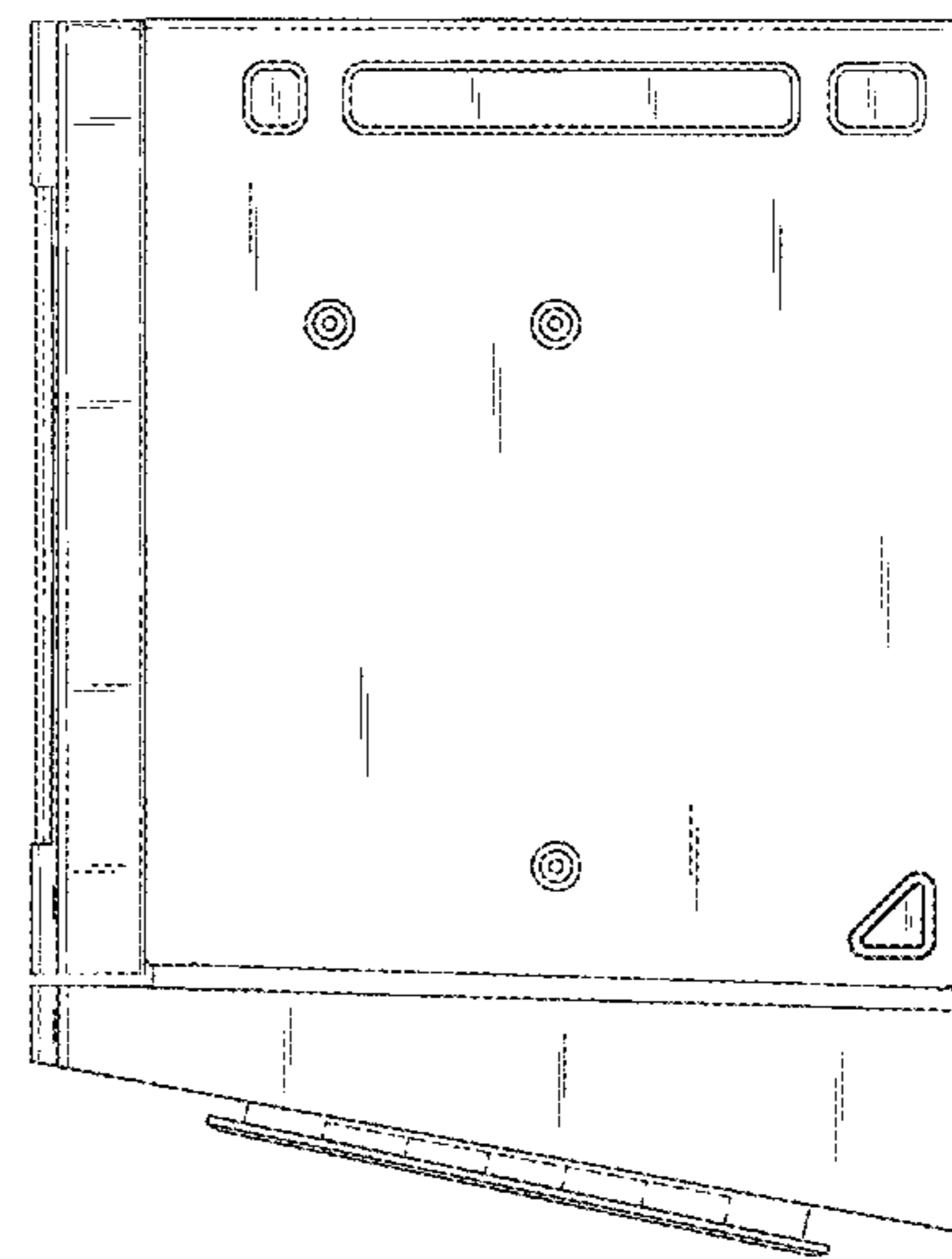
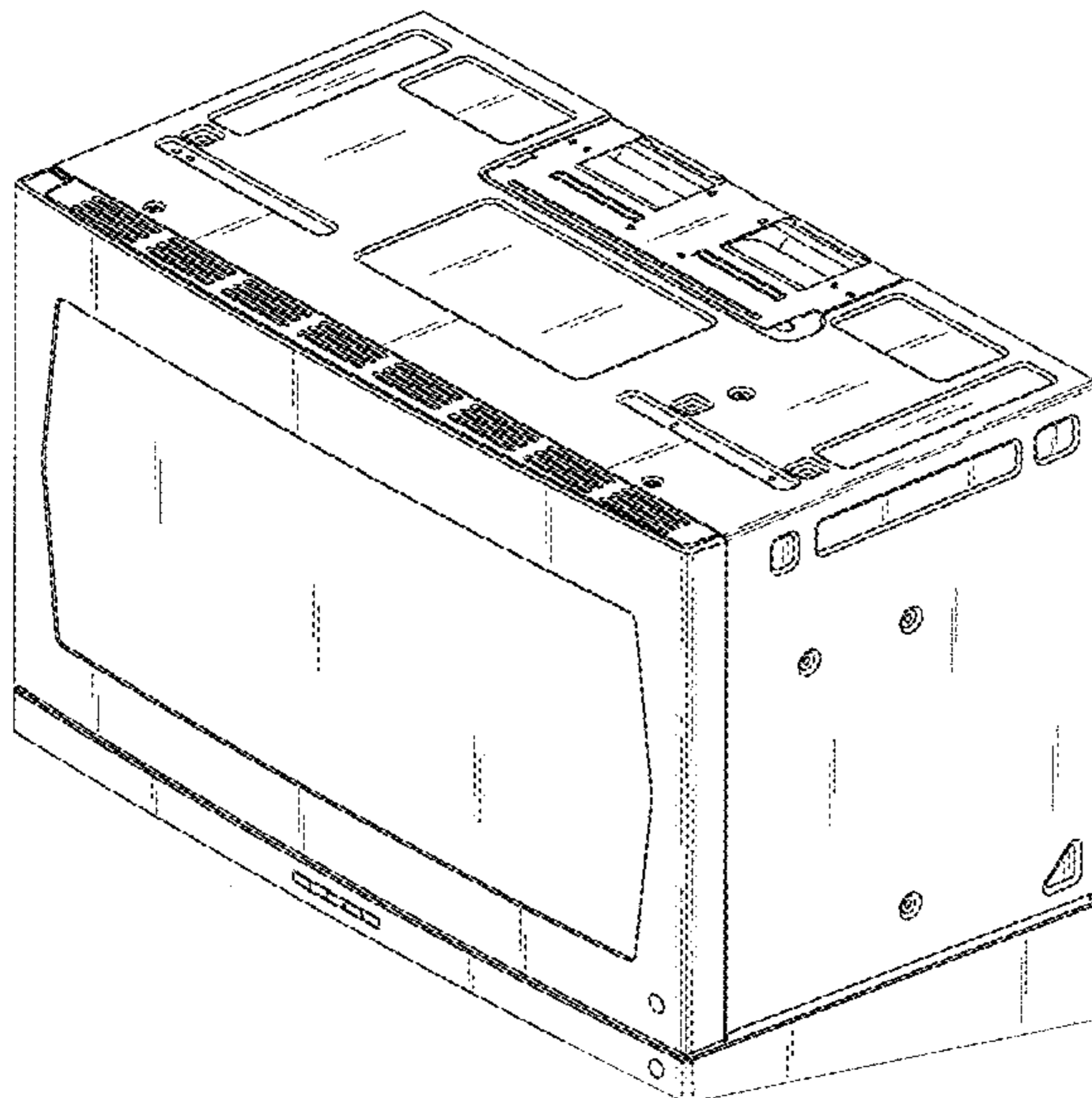

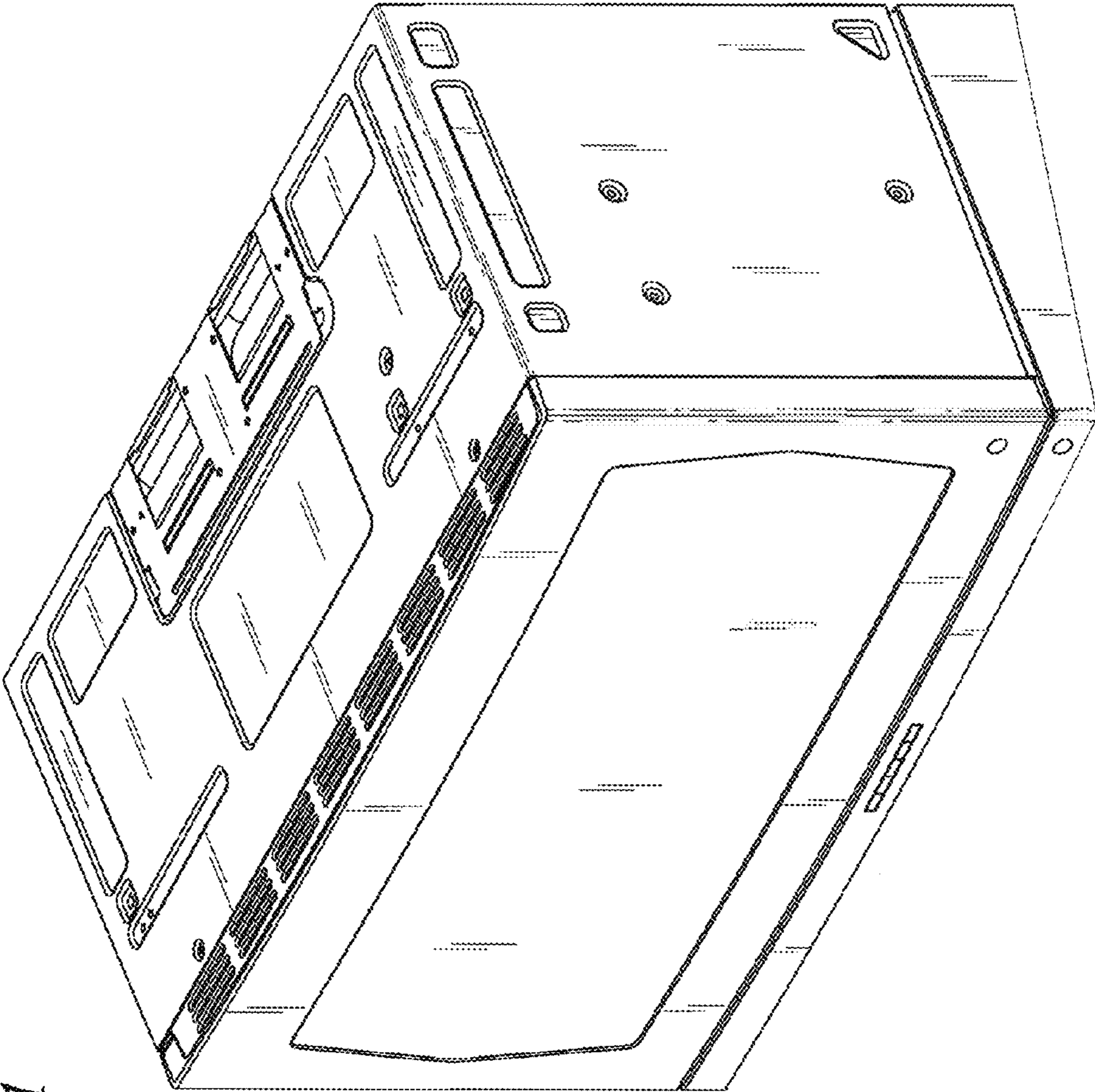

Fig. 1

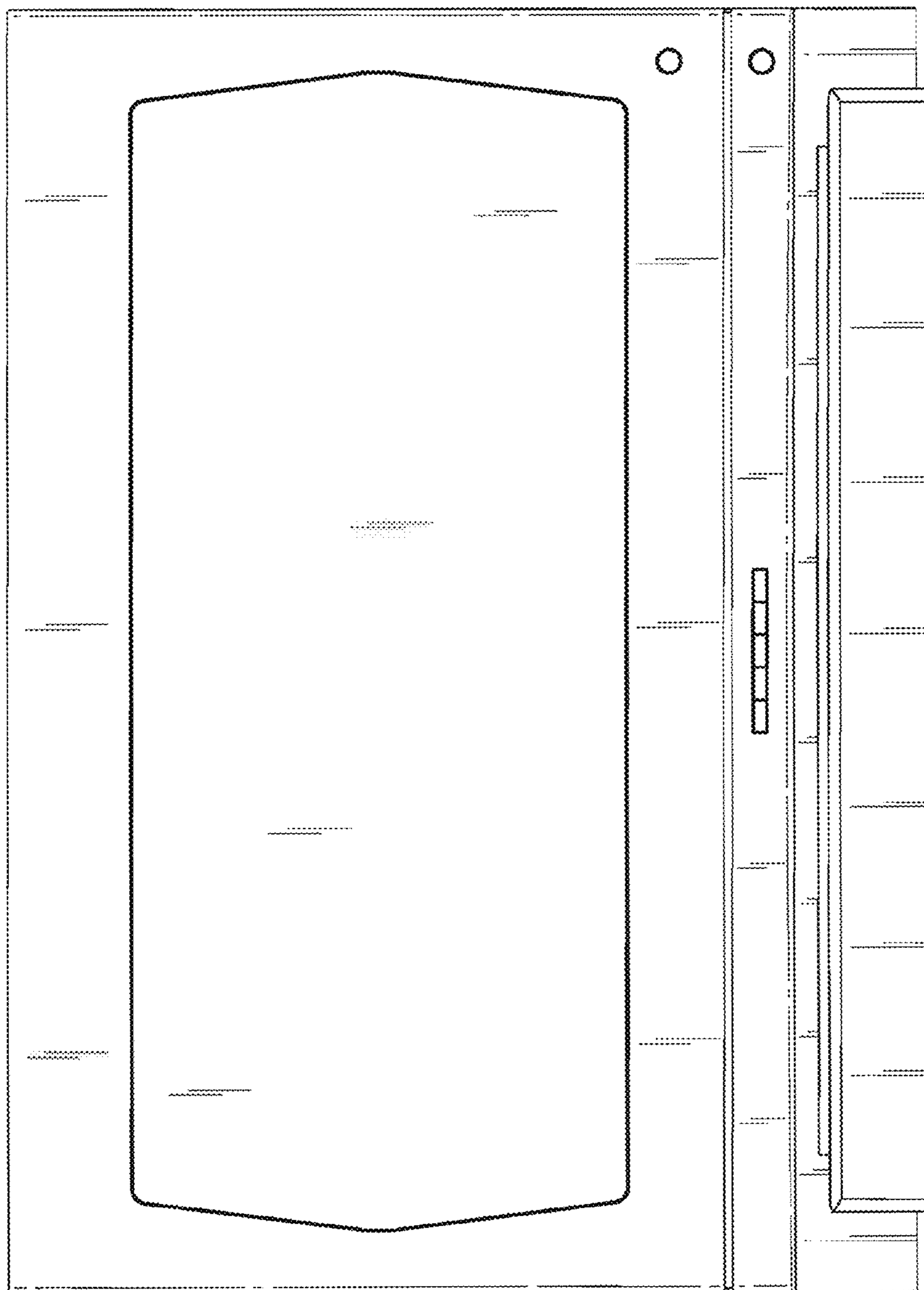

Fig. 2

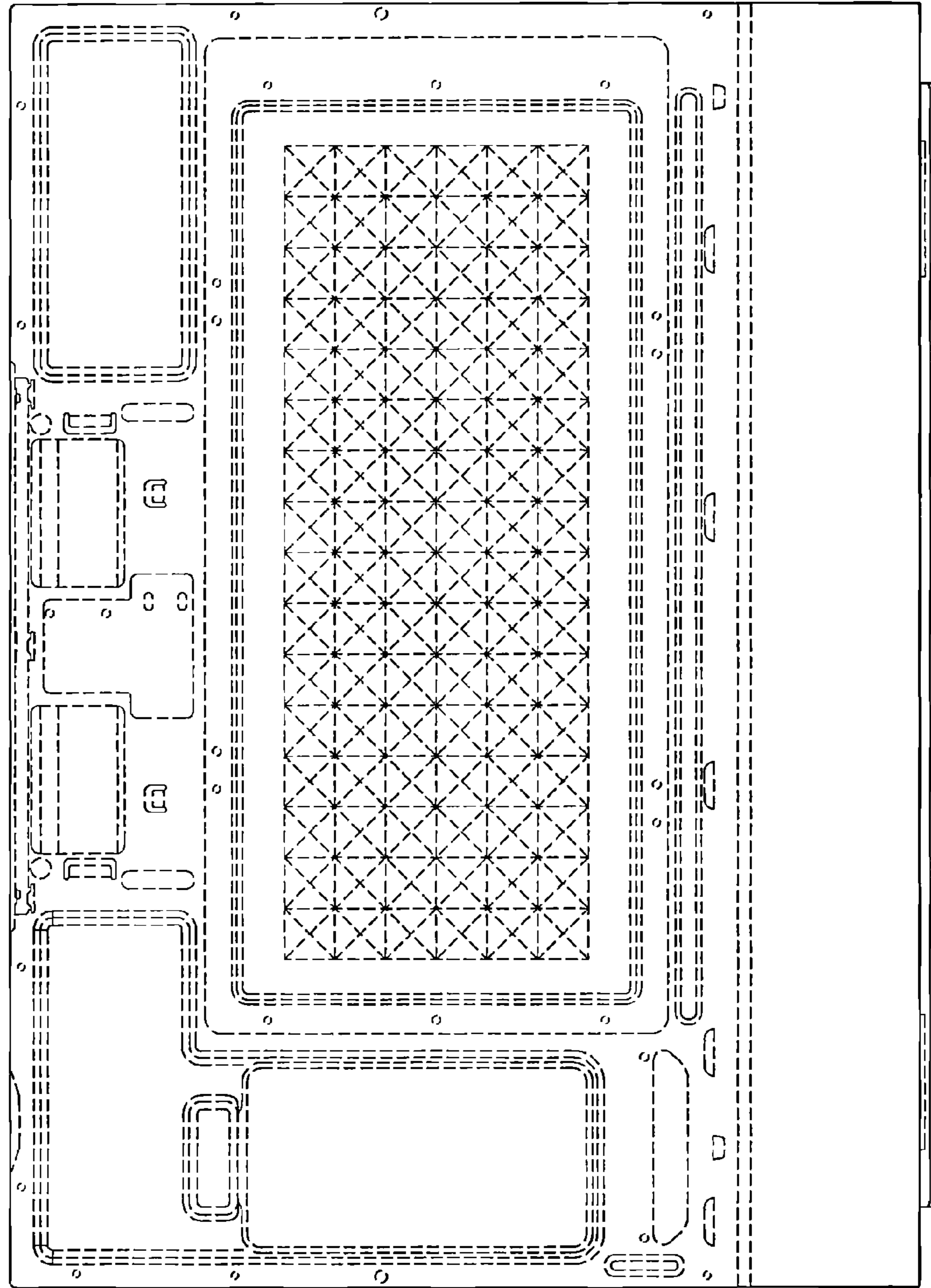

Fig. 3

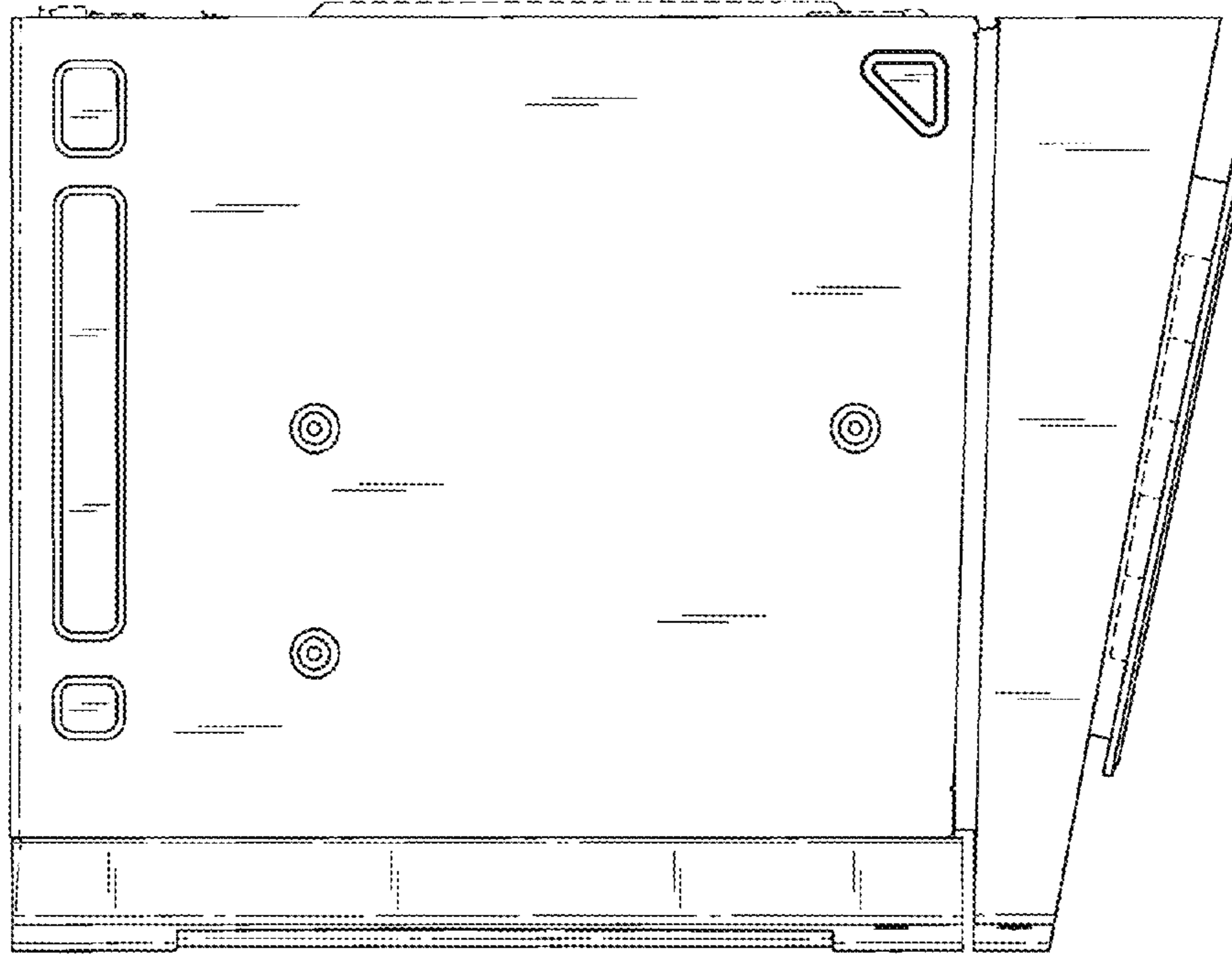

Fig. 5

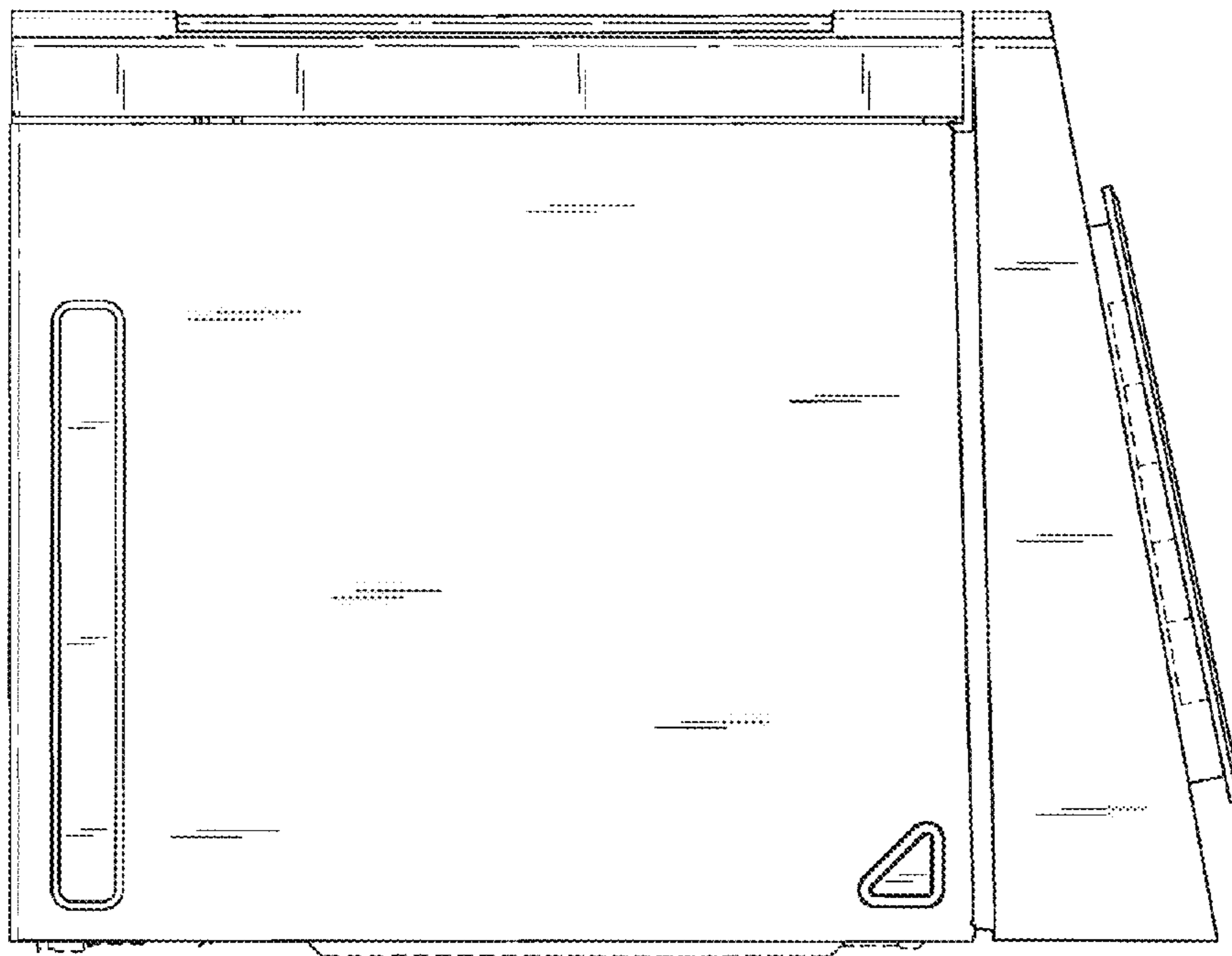

Fig. 4

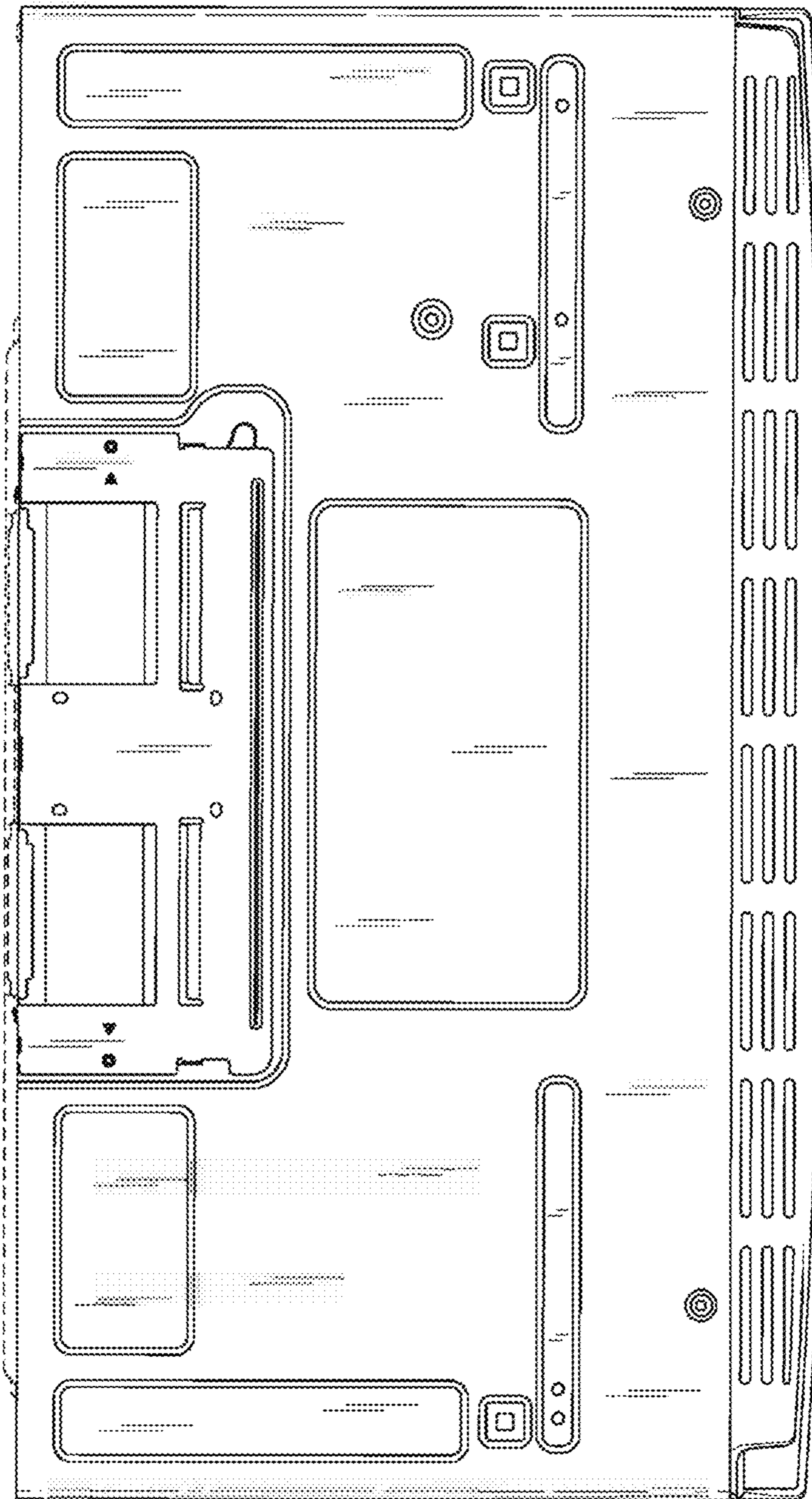

Fig. 6

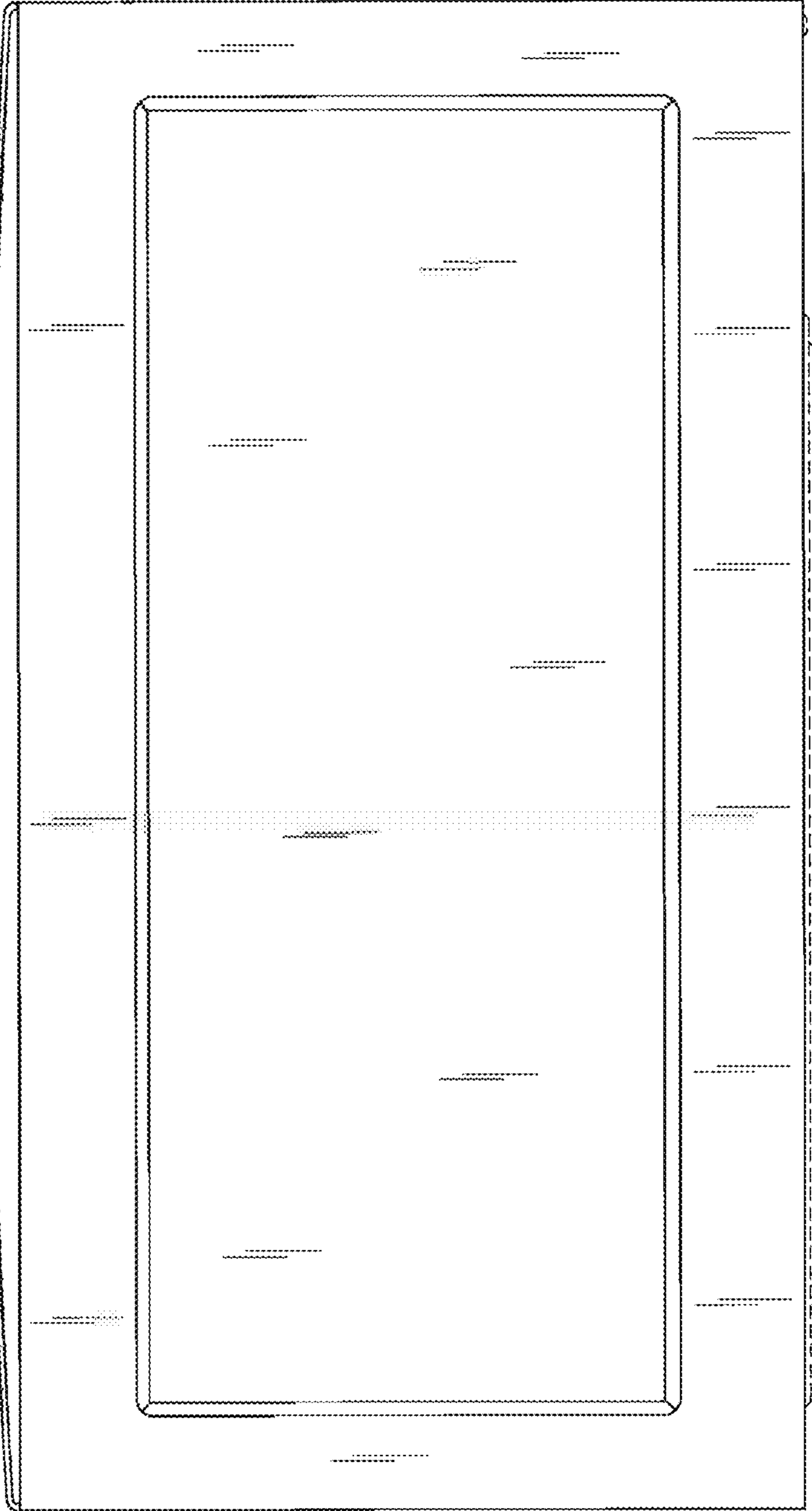

Fig. 7