



US00D733449S

(12) **United States Design Patent**
Adams, IV et al.

(10) **Patent No.:** **US D733,449 S**
(45) **Date of Patent:** **** Jul. 7, 2015**

- (54) **ADIRONDACK CHAIR**
- (71) Applicants: **William E. Adams, IV**, Zelienople, PA (US); **Matthew Goodworth**, Pittsburgh, PA (US)
- (72) Inventors: **William E. Adams, IV**, Zelienople, PA (US); **Matthew Goodworth**, Pittsburgh, PA (US)
- (73) Assignee: **Adams Mfg. Corp.**, Portersville, PA (US)
- (**) Term: **14 Years**
- (21) Appl. No.: **29/496,796**
- (22) Filed: **Jul. 17, 2014**
- (51) **LOC (10) Cl.** **06-01**
- (52) **U.S. Cl.**
USPC **D6/370**
- (58) **Field of Classification Search**
USPC D6/334-336, 361, 370, 374, 379, 380, D6/716, 716.1, 716.2, 716.3, 716.4
CPC A47C 3/04; A47C 4/02; A47C 4/03; A47C 5/12; A47C 7/16
See application file for complete search history.

2,650,652 A	9/1953	Watson
2,843,195 A	7/1958	Barvaeus
3,845,986 A	11/1974	Rowland
4,522,446 A	6/1985	Sheridan
4,541,670 A	9/1985	Morgenstern et al.
4,635,998 A	1/1987	Hickey
4,707,023 A	11/1987	Hickey
D295,927 S	5/1988	Hickey
4,890,881 A	1/1990	Ollat et al.
4,976,492 A	12/1990	Ziegler
D319,354 S	8/1991	Wolcott
5,044,691 A	9/1991	Guichon
5,120,071 A	6/1992	Thibault et al.
D334,299 S	3/1993	Embree
5,240,214 A	8/1993	Birnbaum et al.
D360,537 S	7/1995	vanSkiver
D362,556 S	9/1995	vanSkiver
D366,771 S	2/1996	Lyons
5,511,849 A	4/1996	Cahaley et al.
D384,511 S	10/1997	Gresens
D407,227 S	3/1999	Walters
D407,228 S	3/1999	Walters
5,911,469 A	6/1999	Young
D413,452 S	9/1999	Rhienen
D413,453 S	9/1999	van Rhienen
D413,736 S	9/1999	Jackson

(Continued)

Primary Examiner — Mimosa De
(74) *Attorney, Agent, or Firm* — Buchanan Ingersoll & Rooney PC

(56) **References Cited**
U.S. PATENT DOCUMENTS

D68,027 S	8/1925	Wurdack	
D78,926 S	7/1929	Gottlob	
D84,585 S	7/1931	Ledder et al.	
2,072,075 A	2/1937	Travers et al.	
D109,239 S *	4/1938	Wolpin	D6/370
2,192,672 A	3/1940	Connor, Jr.	
2,195,461 A	4/1940	Koenig	
2,222,296 A	11/1940	Luiken	
D148,391 S	1/1948	Plourde et al.	
2,490,884 A	12/1949	Rau	
2,517,039 A	8/1950	Shook	
2,600,626 A	6/1952	Ellingson	
2,603,273 A	7/1952	Gambrill	

(57) **CLAIM**
The ornamental design for an adirondack chair, as shown and described.

DESCRIPTION

FIG. 1 is a front view of our adirondack chair;
FIG. 2 is a top view thereof
FIG. 3 is a left side view thereof;
FIG. 4 is a right side view thereof;
FIG. 5 is a bottom view thereof;
FIG. 6 is a back view thereof; and,
FIG. 7 is a perspective view thereof.

1 Claim, 7 Drawing Sheets

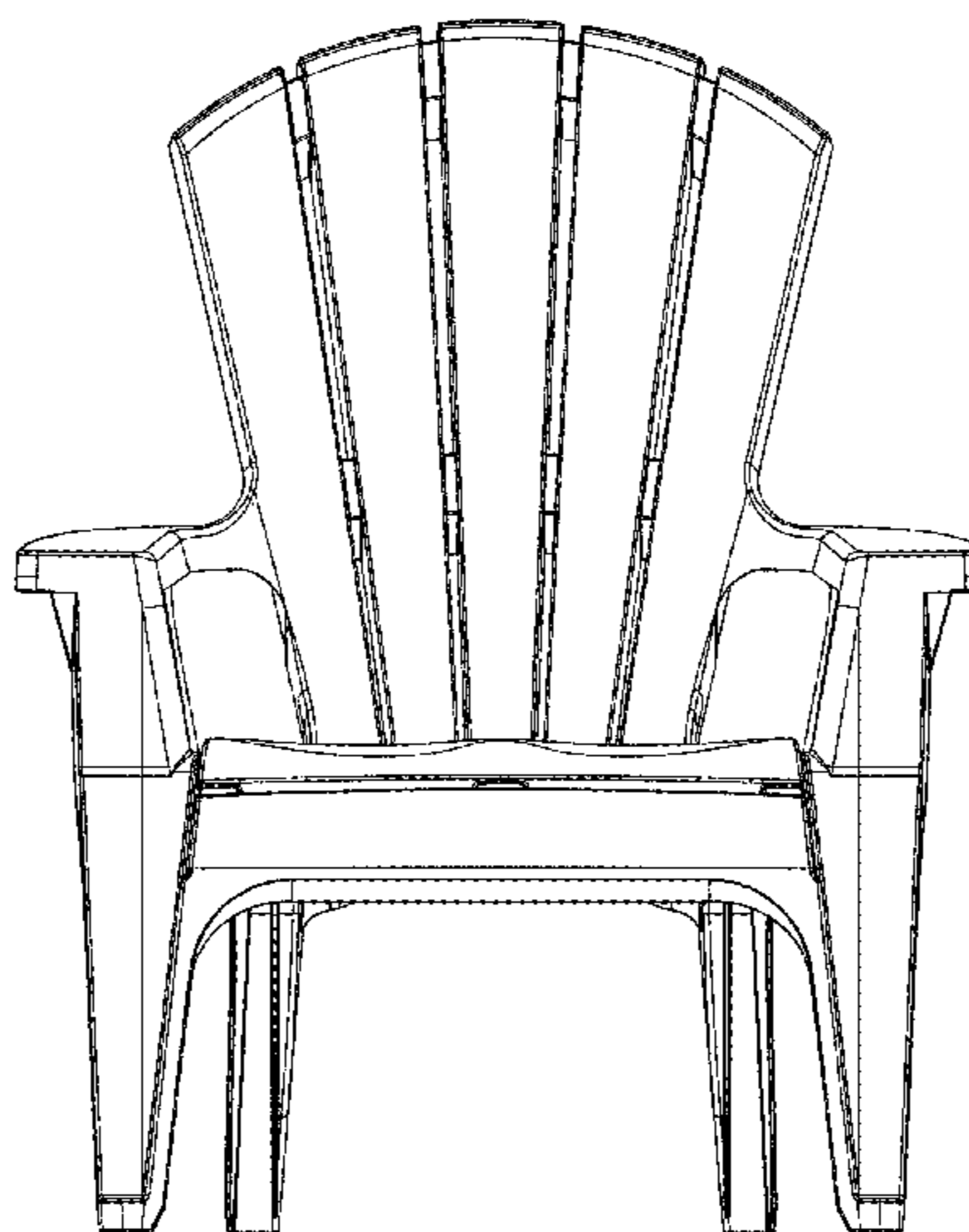

(56)

References Cited

U.S. PATENT DOCUMENTS

D416,397 S	11/1999	Niemiec	6,986,549 B2	1/2006	Kniese	
5,997,094 A	12/1999	Cvek	D538,086 S	3/2007	Shake	
6,003,946 A	12/1999	Jackson	D570,127 S	6/2008	Spink	
D418,323 S	1/2000	van Rhienen	7,401,854 B2	7/2008	Adams	
D420,824 S	2/2000	Lin	D607,223 S	1/2010	Adams et al.	
D425,719 S	5/2000	Chalmers et al.	7,748,786 B1	7/2010	Brower	
D430,748 S	9/2000	Chalmers et al.	D646,068 S	10/2011	Bogdan et al.	
D443,430 S *	6/2001	Anderson et al.	D660,040 S	5/2012	Bogdan et al.	
	 D6/370	8,333,430 B2	12/2012	Adams et al.	
6,616,228 B2	9/2003	Heidmann	D677,069 S	3/2013	Adams, IV	
6,688,687 B2	2/2004	Chu	D704,464 S *	5/2014	Mifsud	D6/361
D503,550 S	4/2005	Miesieski et al.	D712,172 S *	9/2014	Saylor	D6/370
D509,970 S	9/2005	Adams	D717,058 S *	11/2014	Prokofiev et al.	D6/370
			2005/0200167 A1	9/2005	Bollenbach	
			2006/0163920 A1	7/2006	Adams	

* cited by examiner

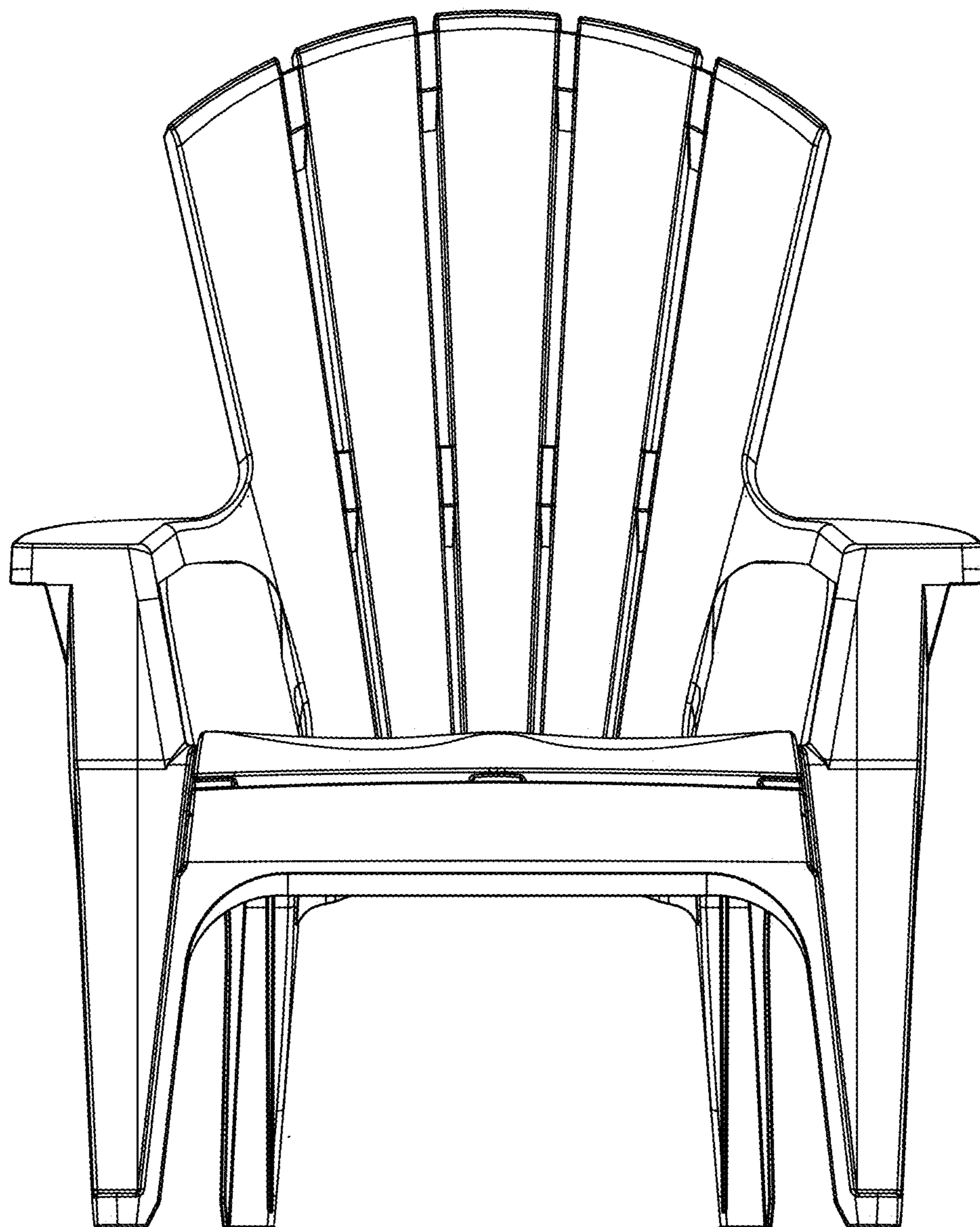

FIG. 1

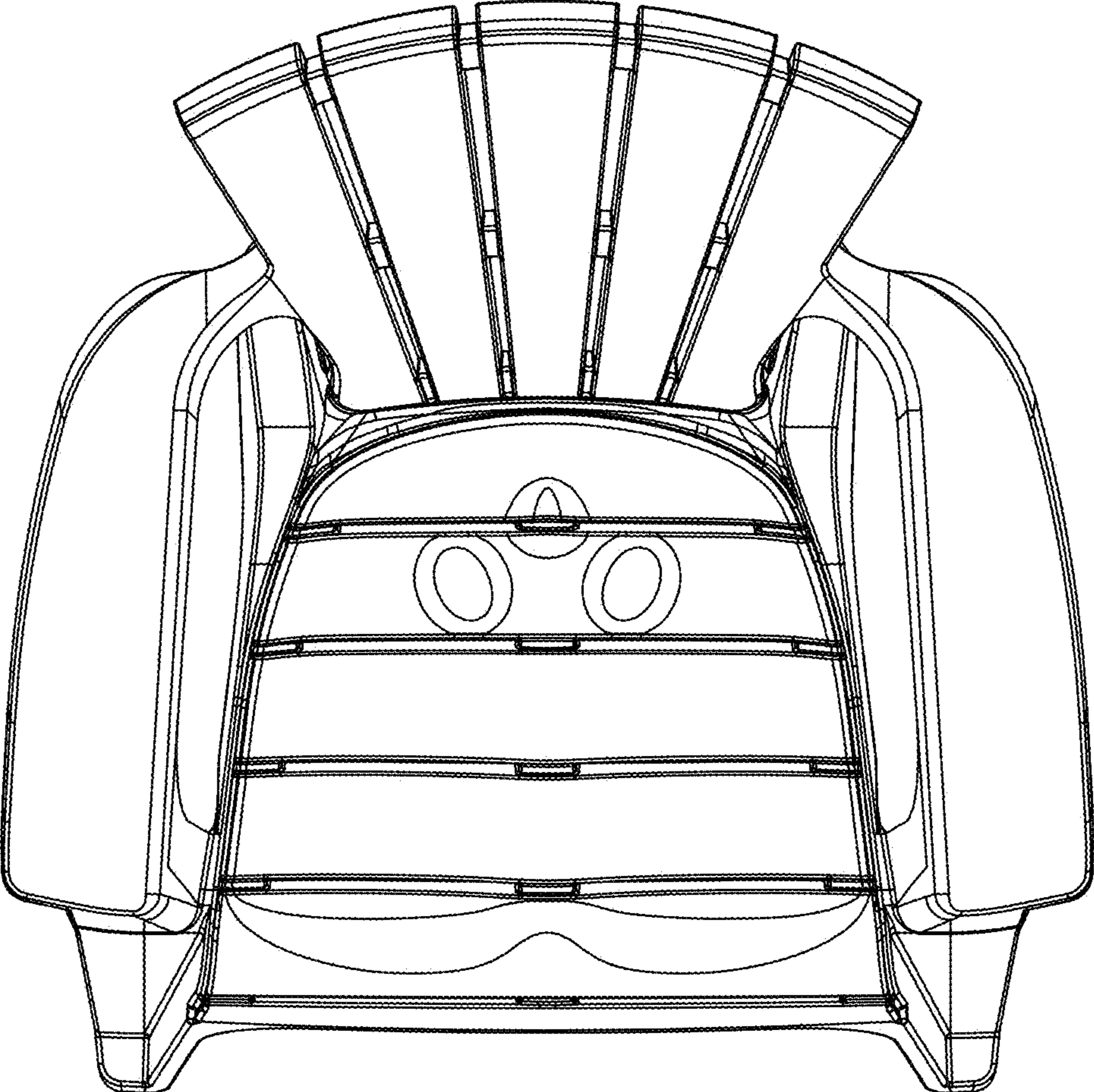

FIG. 2

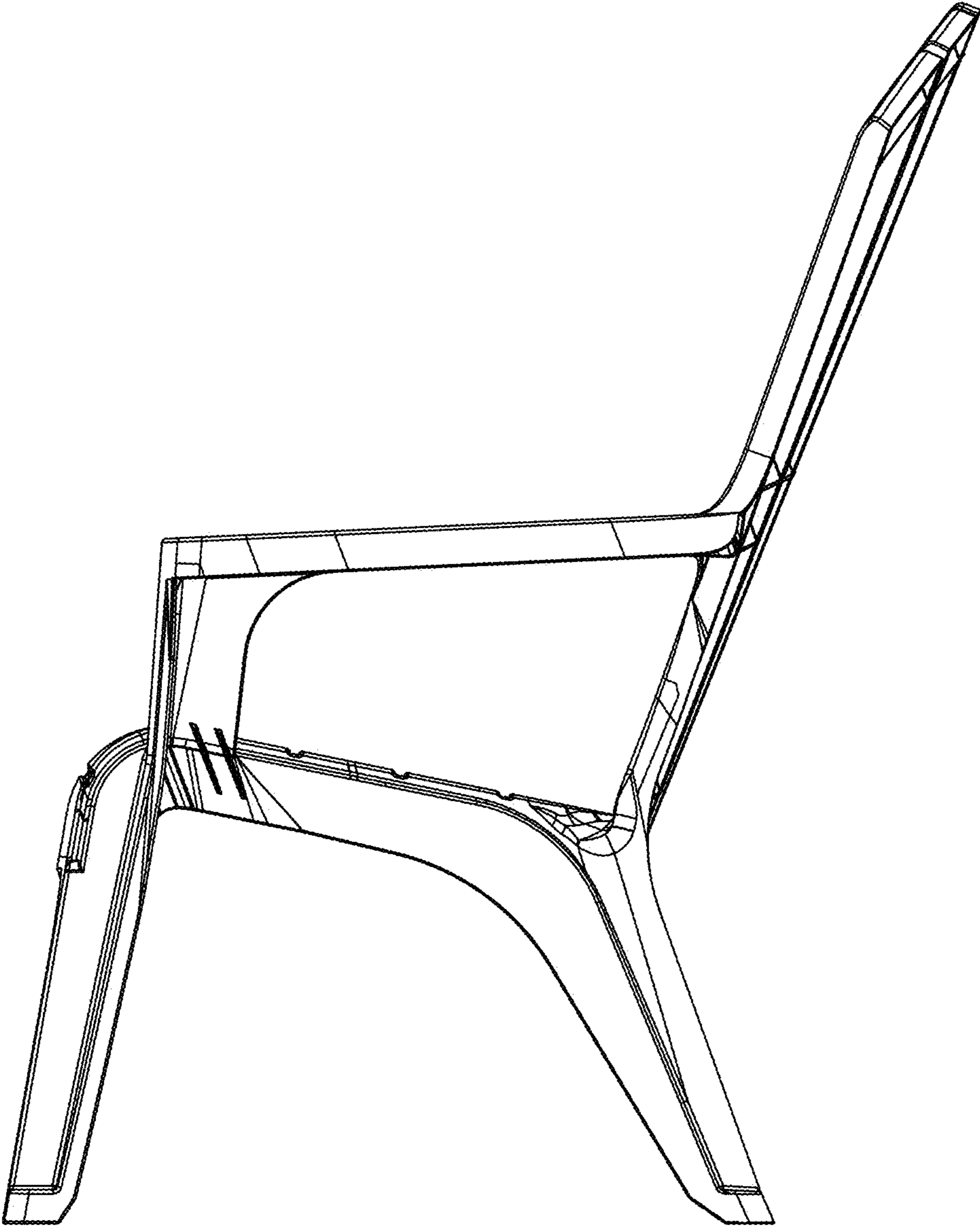

FIG. 3

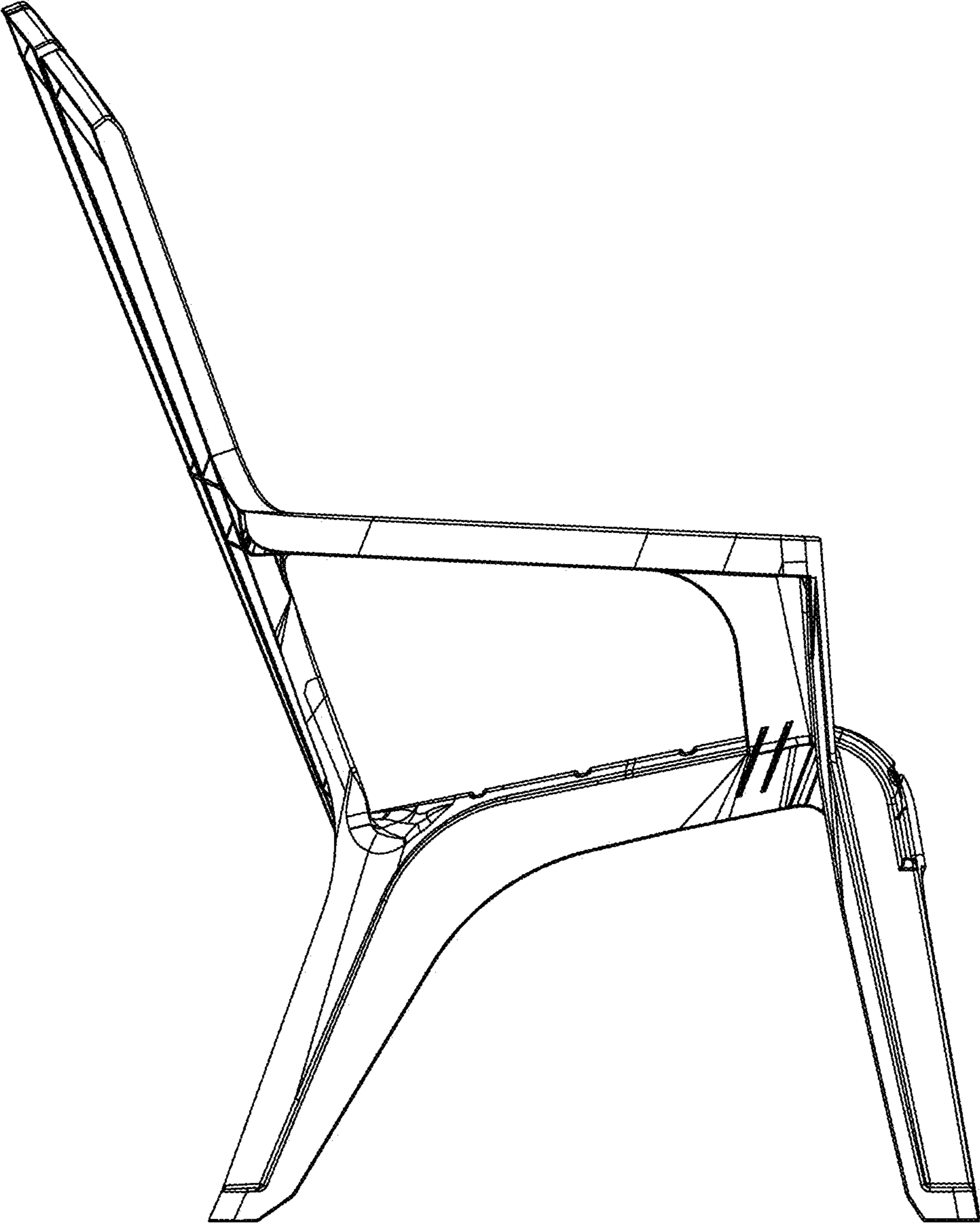

FIG. 4

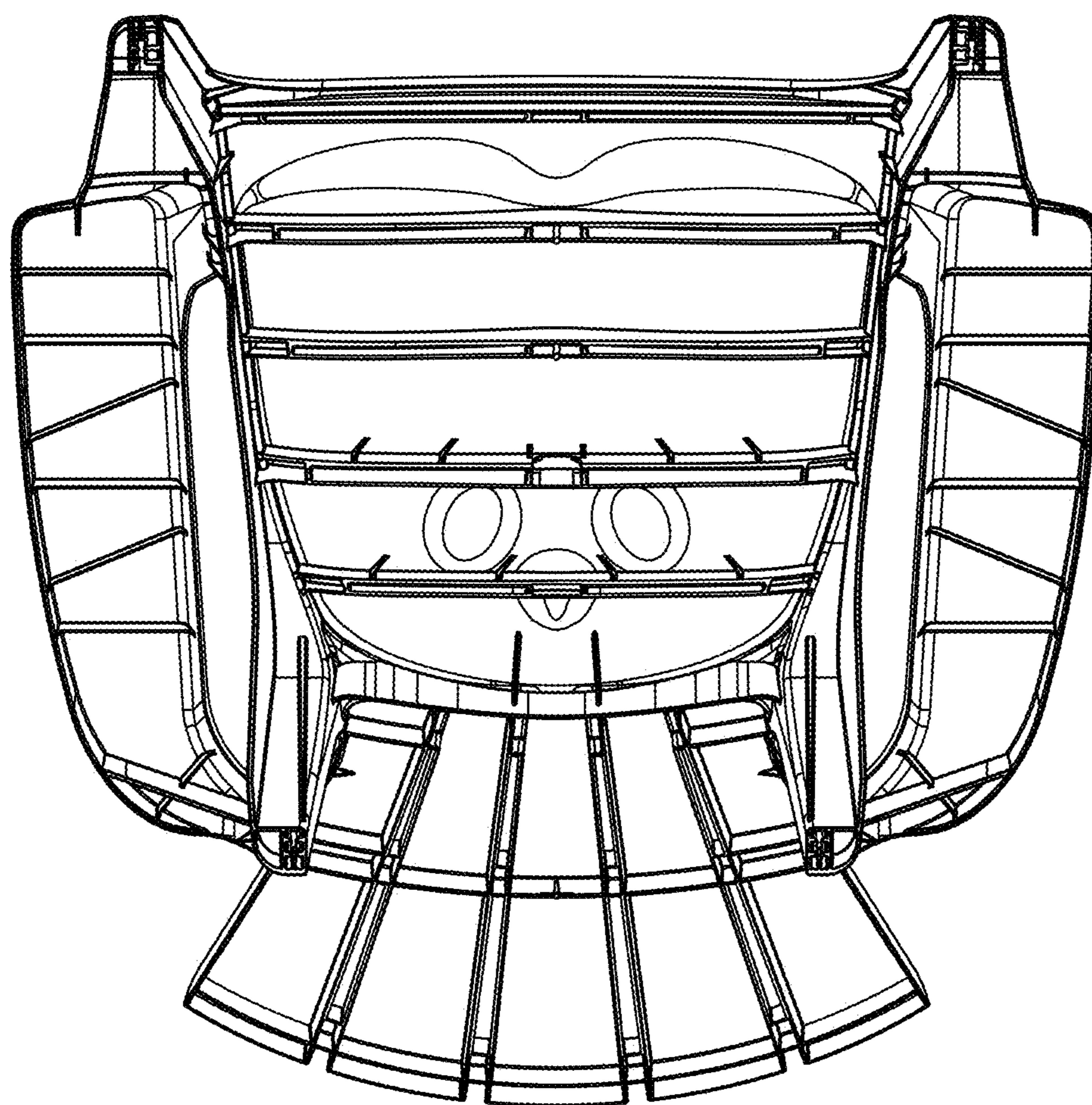

FIG. 5

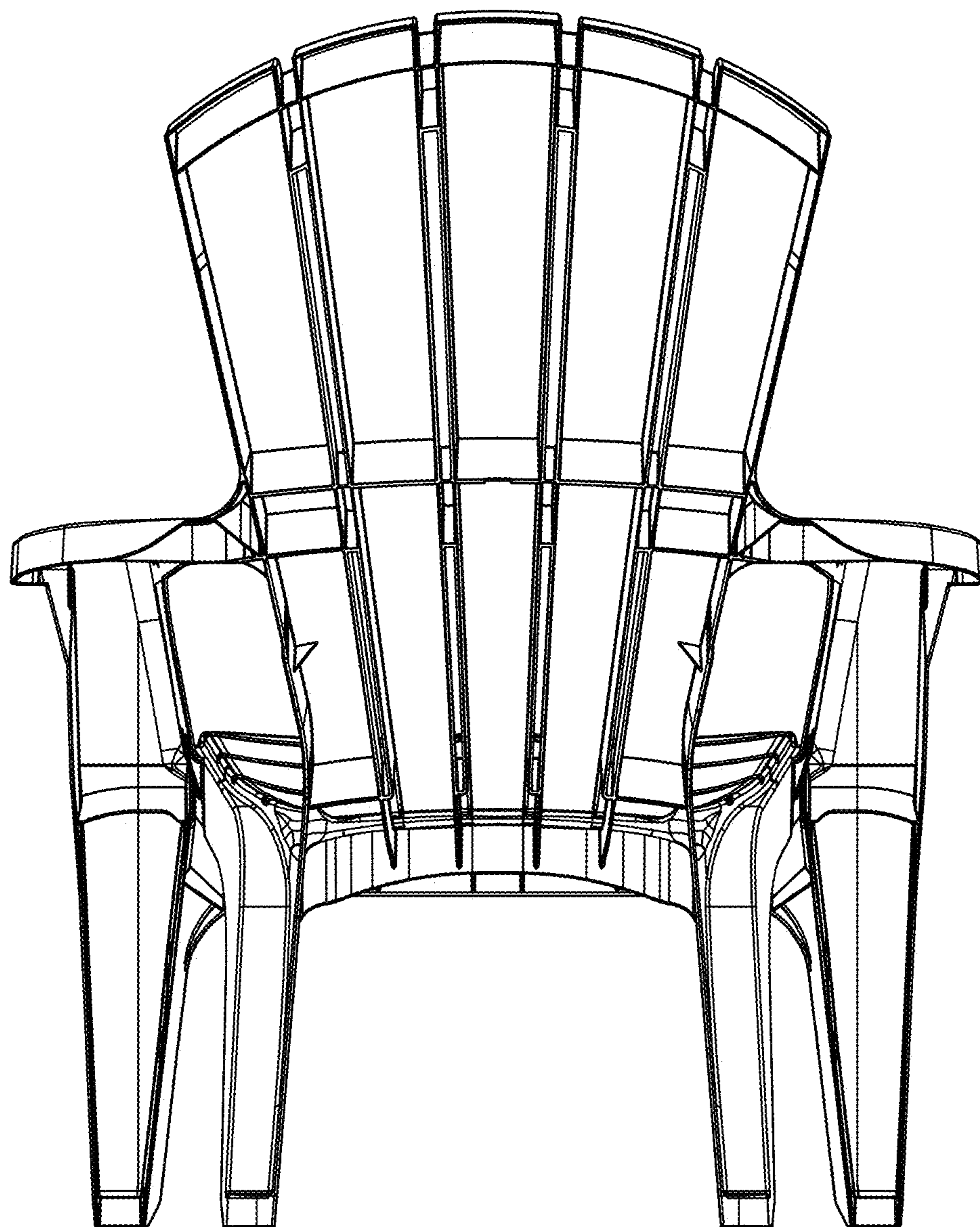

FIG. 6

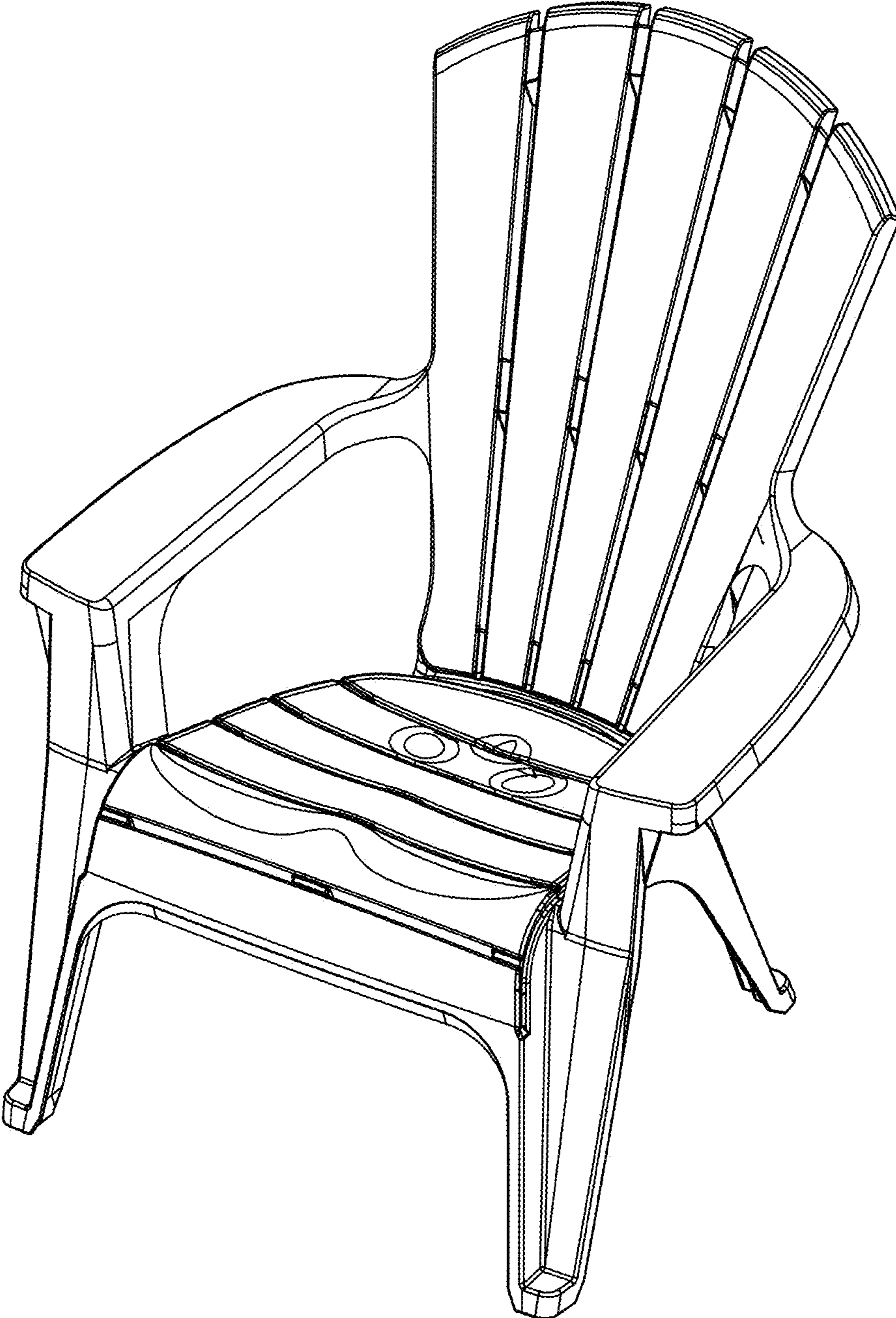

FIG. 7