



US00D733428S

(12) **United States Design Patent**
Sijmons

(10) **Patent No.:** **US D733,428 S**
(45) **Date of Patent:** **** Jul. 7, 2015**

(54) **LUGGAGE**

D425,301 S 5/2000 Sagol
6,345,709 B1 * 2/2002 Cheng 190/119
D454,430 S 3/2002 Sijmons

(71) Applicant: **Samsonite IP Holdings S.a.r.l.**,
Luxembourg (LU)

(Continued)

(72) Inventor: **Erik Sijmons**, Oudenaarde (BE)

FOREIGN PATENT DOCUMENTS

(73) Assignee: **Samsonite IP Holdings S.a.r.l.**,
Luxembourg (LU)

EM 000615984-0001 11/2006
EM 000816178-0001 11/2007

(Continued)

(**) Term: **14 Years**

OTHER PUBLICATIONS

(21) Appl. No.: **29/479,409**

Rimowa tango-Light 32" Trolley Multiwheel. Downloaded Dec. 21, 2007 at http://www.ebags.com/rimowa/tango_light_32_trolley_multiwheel_reg/product..., 2007, 2 pages.

(22) Filed: **Jan. 15, 2014**

(Continued)

(30) **Foreign Application Priority Data**

Jul. 19, 2013 (EM) 002277962-0003

Primary Examiner — Jennifer Rivard

(51) **LOC (10) CL.** **03-01**

Assistant Examiner — April Rivas

(52) **U.S. CL.**

(74) *Attorney, Agent, or Firm* — Dorsey & Whitney LLP

USPC **D3/279**; D3/294

(57)

CLAIM

(58) **Field of Classification Search**

USPC D3/273, 276, 279, 289, 301, 283, 272,
D3/278, 274, 281, 321, 902, 292, 232;
190/18 A, 100-127; 206/286-287.1;
D34/25

The ornamental design for luggage, as shown and described.

CPC A45C 7/00; A45C 5/14; A45C 13/28;
A45C 5/03

DESCRIPTION

See application file for complete search history.

FIG. 1 shows a front perspective view of a piece of luggage;
FIG. 2 shows a front elevation view of the piece of luggage of FIG. 1;
FIG. 3 shows a rear elevation view of the piece of luggage of FIG. 1;
FIG. 4 shows a right elevation view of the piece of luggage of FIG. 1;
FIG. 5 shows a left elevation view of the piece of luggage of FIG. 1;
FIG. 6 shows a top view of the piece of luggage of FIG. 1; and,
FIG. 7 shows a bottom view of the piece of luggage of FIG. 1.
The broken lines illustrate portions of the luggage and form no part of the claimed design.

(56) **References Cited**

U.S. PATENT DOCUMENTS

3,044,215 A * 7/1962 Crousore 47/41.13
D196,478 S 10/1963 Holtzman
D263,339 S 3/1982 Tellman
D299,589 S 1/1989 Uchiyama
5,197,578 A 3/1993 Van Hooreweder

1 Claim, 7 Drawing Sheets

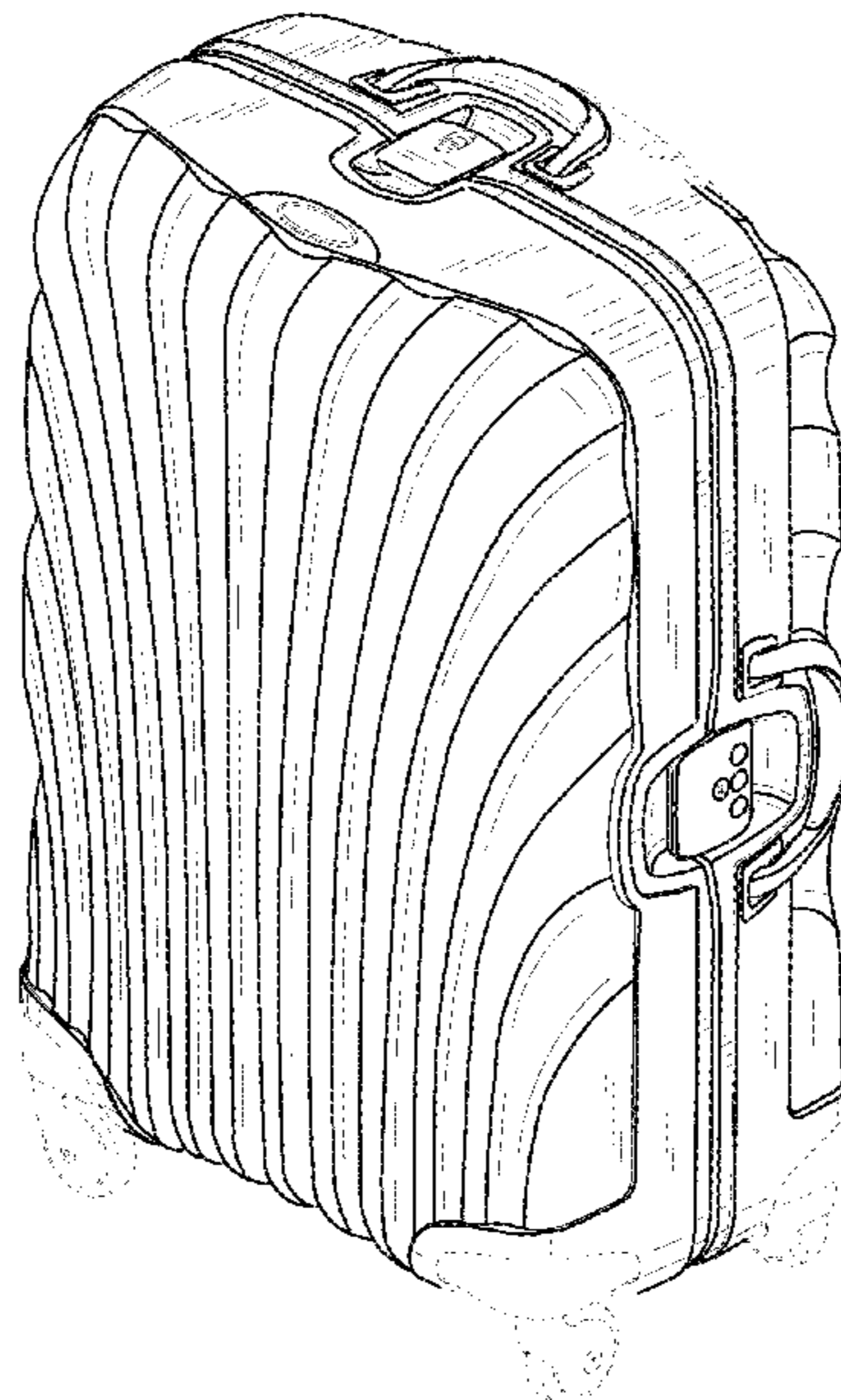

(56)

References Cited

U.S. PATENT DOCUMENTS

D462,169 S 9/2002 Giovanni
 D479,042 S 9/2003 Szyf
 D479,651 S 9/2003 Shen
 6,627,271 B1 * 9/2003 Okazaki 428/16
 D491,360 S 6/2004 Van Himbeeck
 D540,036 S 4/2007 Newson
 D540,540 S 4/2007 Szyf et al.
 7,293,649 B2 11/2007 Gelphman et al.
 D563,101 S 3/2008 Kuchler
 D581,666 S 12/2008 Sijmons
 D582,160 S * 12/2008 Sijmons D3/279
 D587,902 S 3/2009 Yoneno
 D627,162 S * 11/2010 Weng D3/279
 D629,199 S 12/2010 Minneman
 D629,200 S 12/2010 Turella-Yuan
 D633,716 S 3/2011 Turella-Yuan
 D639,555 S 6/2011 Moon
 D642,379 S 8/2011 Buller
 D644,434 S 9/2011 Miles et al.
 D644,435 S 9/2011 Weng
 D659,395 S * 5/2012 Sijmons D3/279
 D665,998 S * 8/2012 Sijmons D3/279
 D675,017 S * 1/2013 Van Overbeke D3/273
 D710,608 S * 8/2014 Yoneno D3/279
 2005/0183579 A1 * 8/2005 Bowers 99/279
 2006/0011437 A1 1/2006 Selvi
 2007/0237920 A1 10/2007 Schoulz

2011/0016018 A1 1/2011 Smith et al.
 2011/0155526 A1 6/2011 Cheng
 2011/0186396 A1 8/2011 Sheikh
 2011/0284334 A1 11/2011 Cheng
 2014/0299430 A1 * 10/2014 Tseng et al. 190/107

FOREIGN PATENT DOCUMENTS

EM 000945175-0001 6/2008
 EM 000951454-0001 6/2008
 EM 001003255-0001 9/2008
 EM 001045520-0001 11/2008
 EM 001651191-0001 12/2009
 EM 001212856-0001 4/2010
 EM 001236632-0001 9/2010
 EM 001236632-0002 9/2010
 EM 001236996-0001 9/2010
 EM 001947789-0003 11/2011
 EM 001988460-0001 2/2012
 EM 002136127-0003 11/2012
 EM 002229815-0001 4/2013
 EM 002344622-0002 11/2013

OTHER PUBLICATIONS

“McQueen’s Quick Silver”, Downloaded at http://www.style.com/trends/blogs/style_file/shopping_news/index.html, Jul. 17, 2008, 1 page.

* cited by examiner

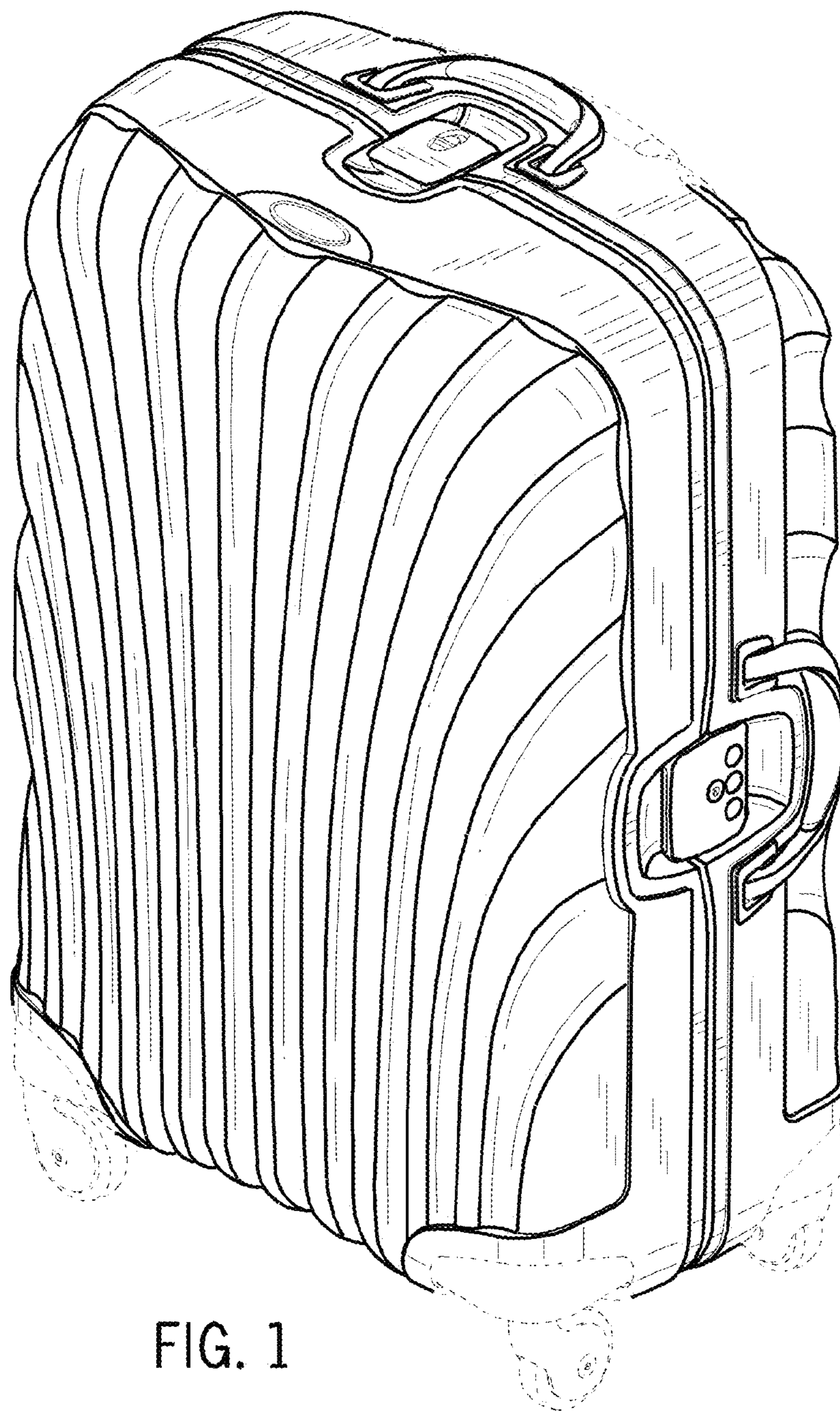

FIG. 1

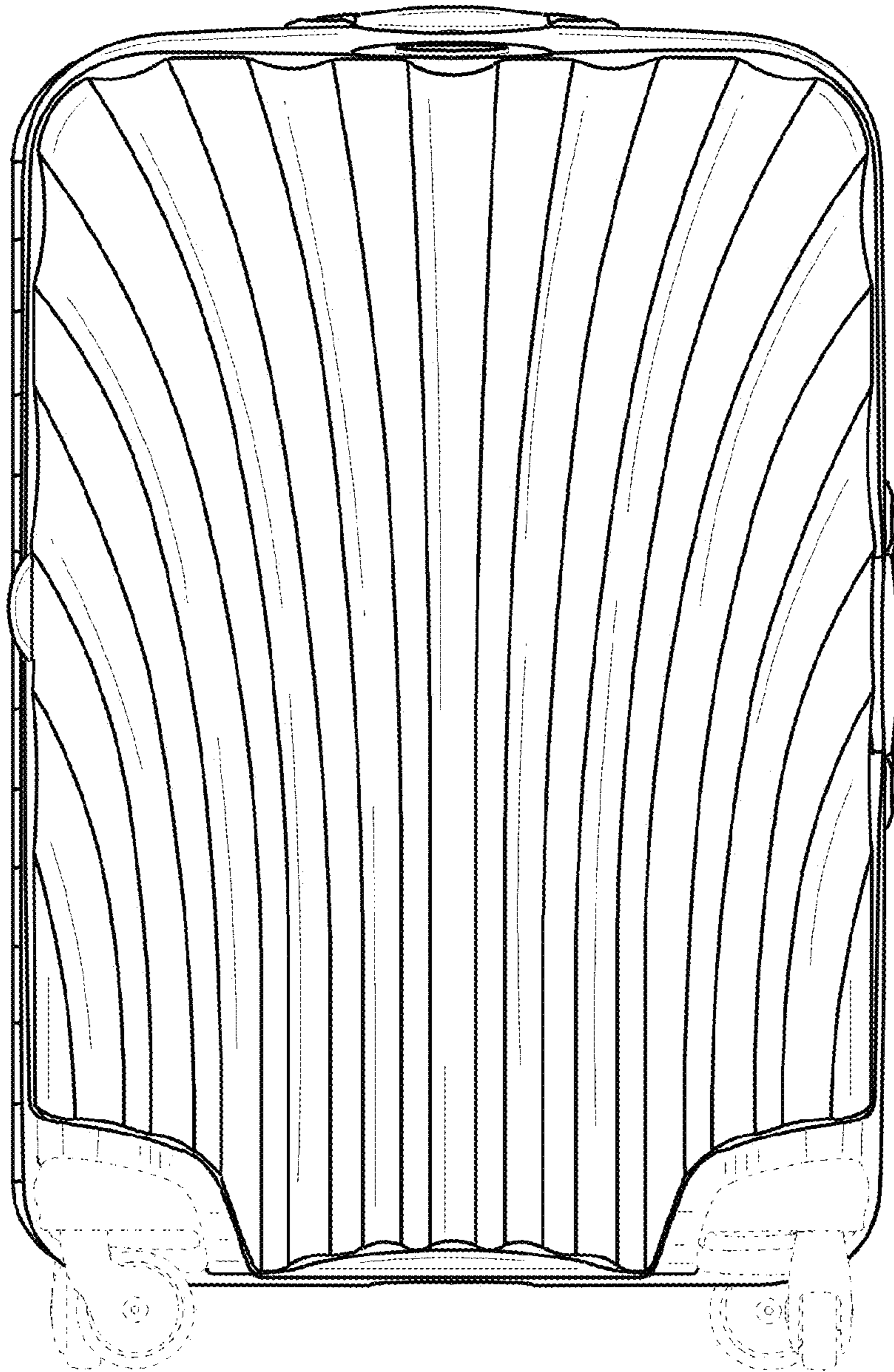

FIG. 2

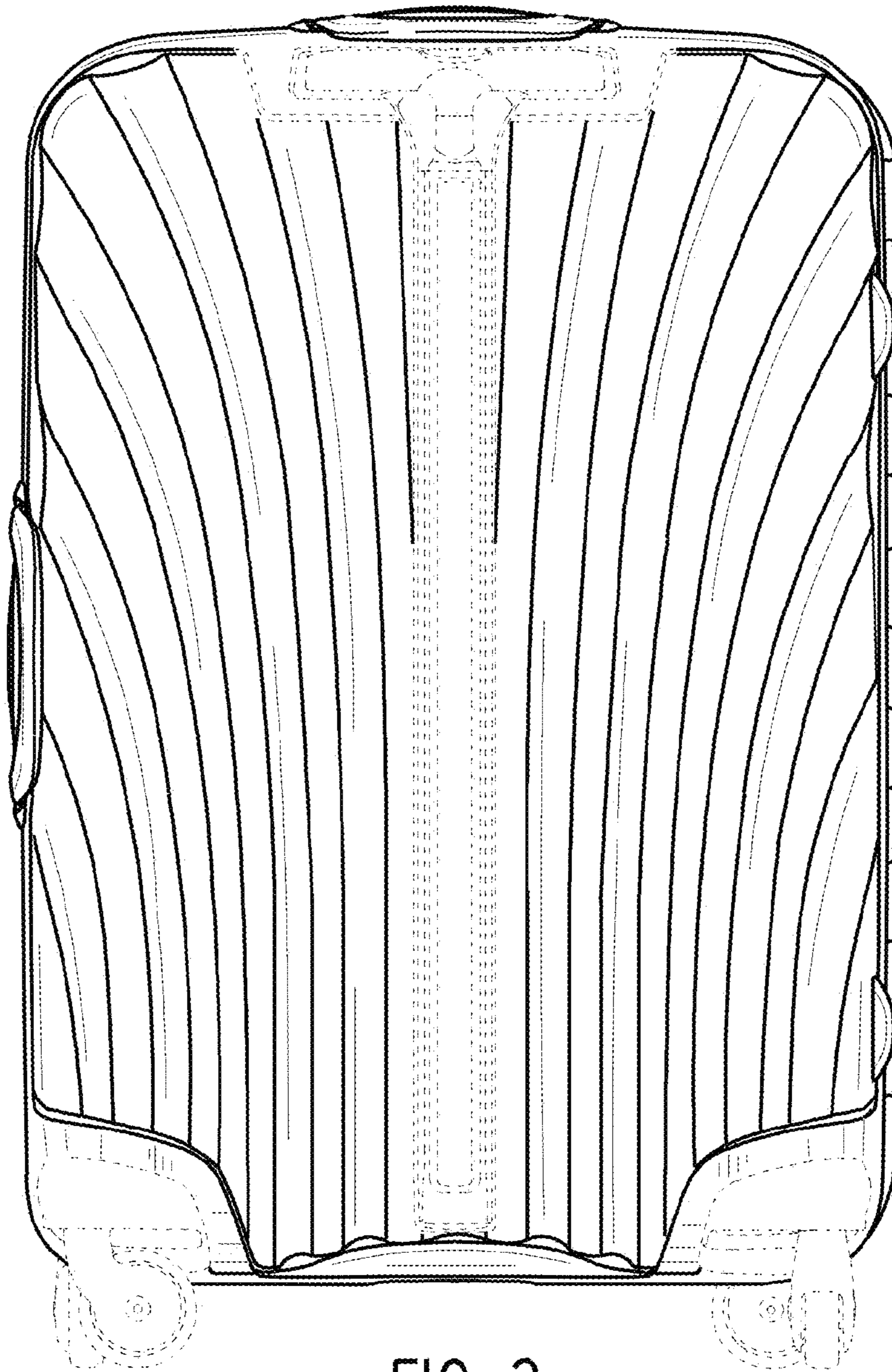

FIG. 3

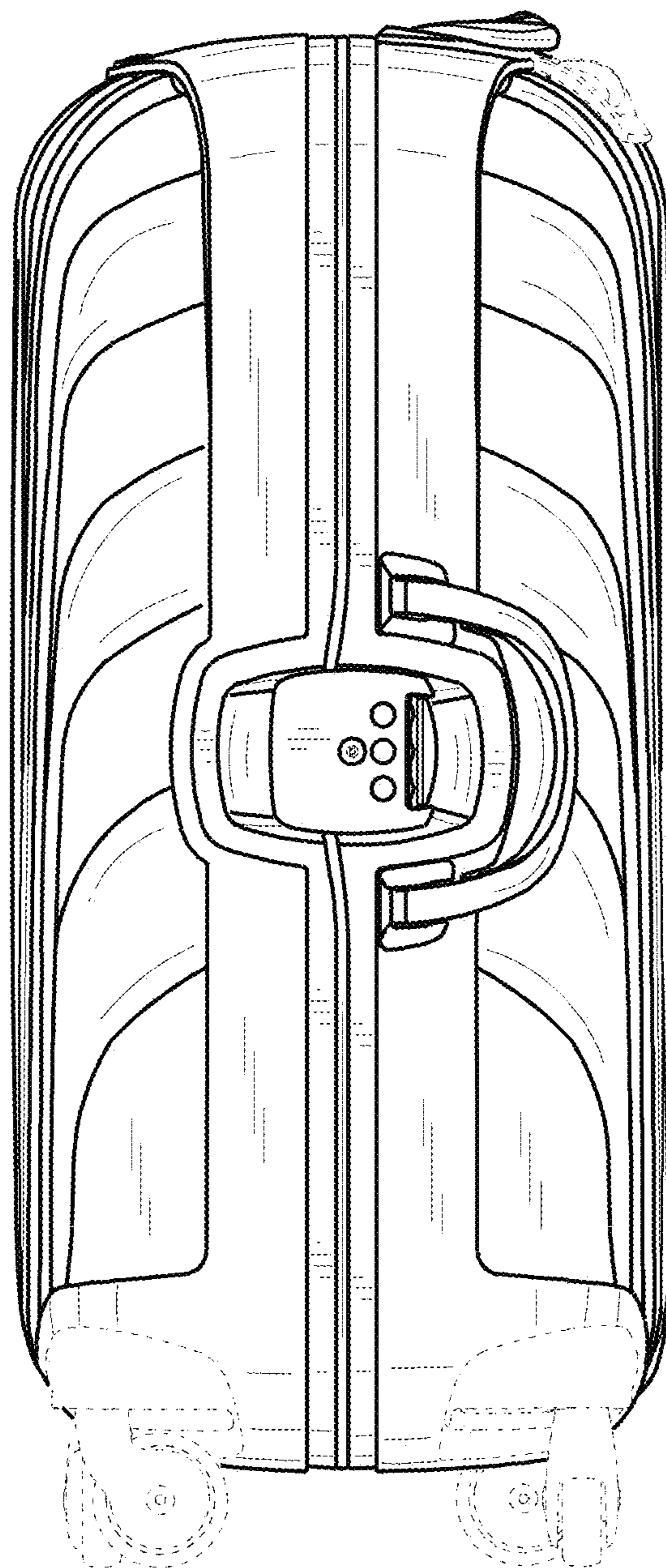

FIG. 4

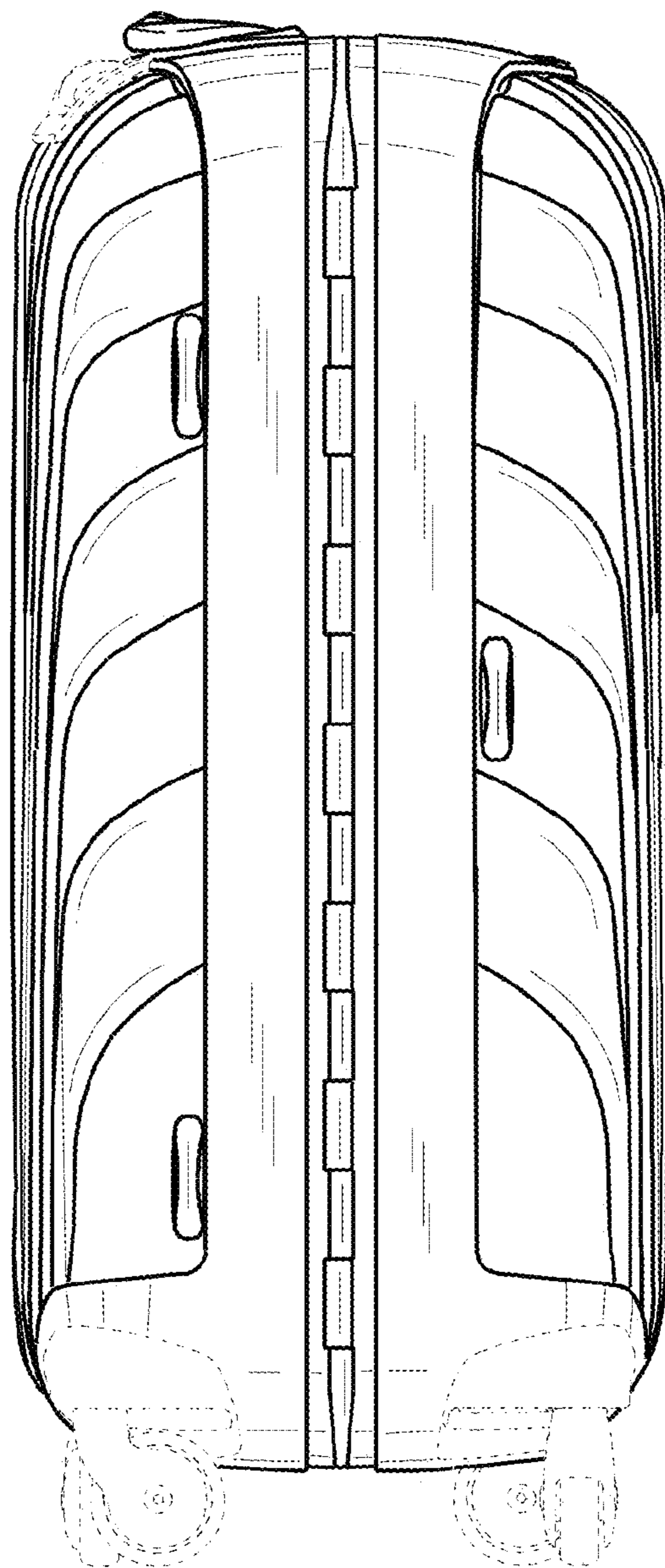

FIG. 5

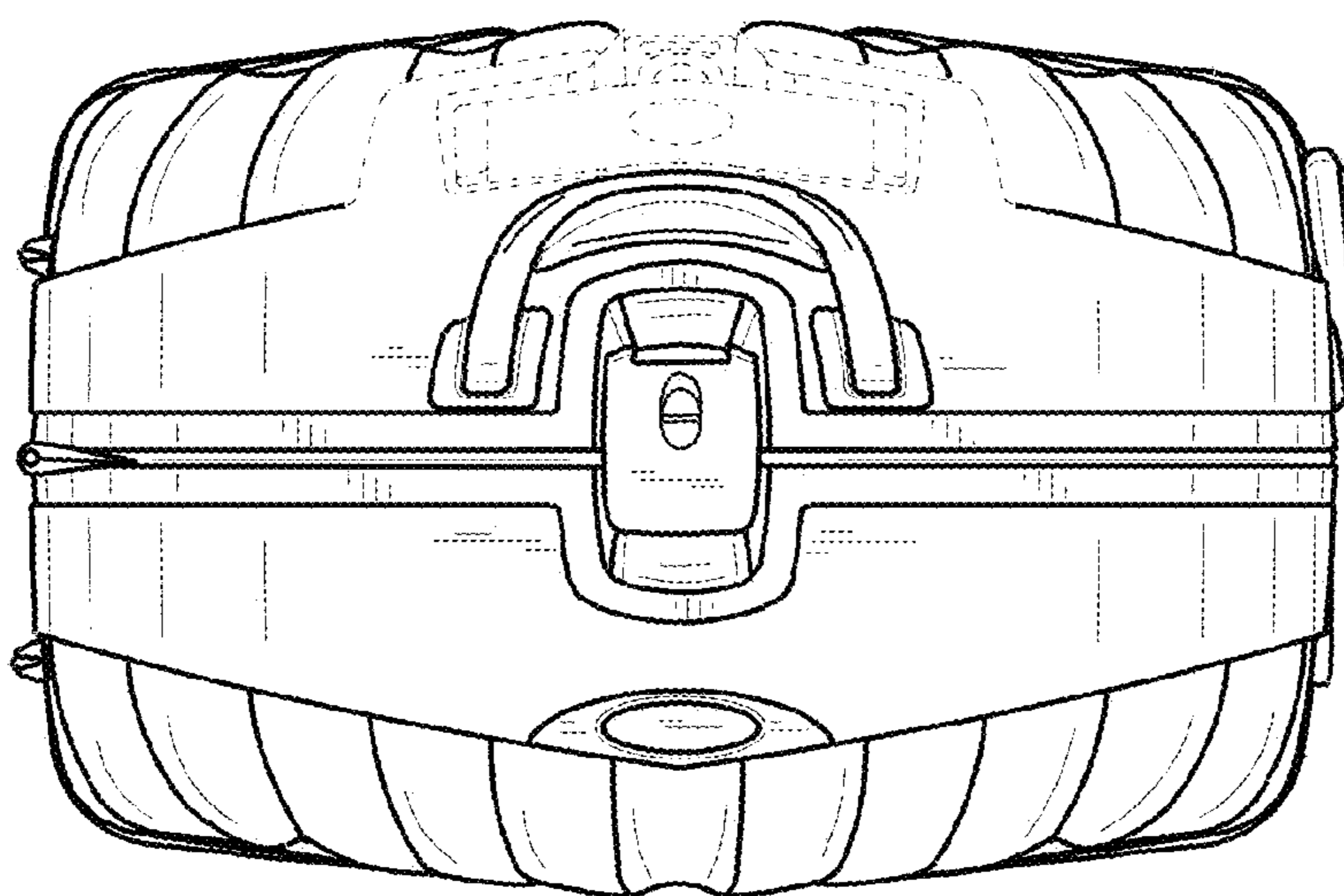

FIG. 6

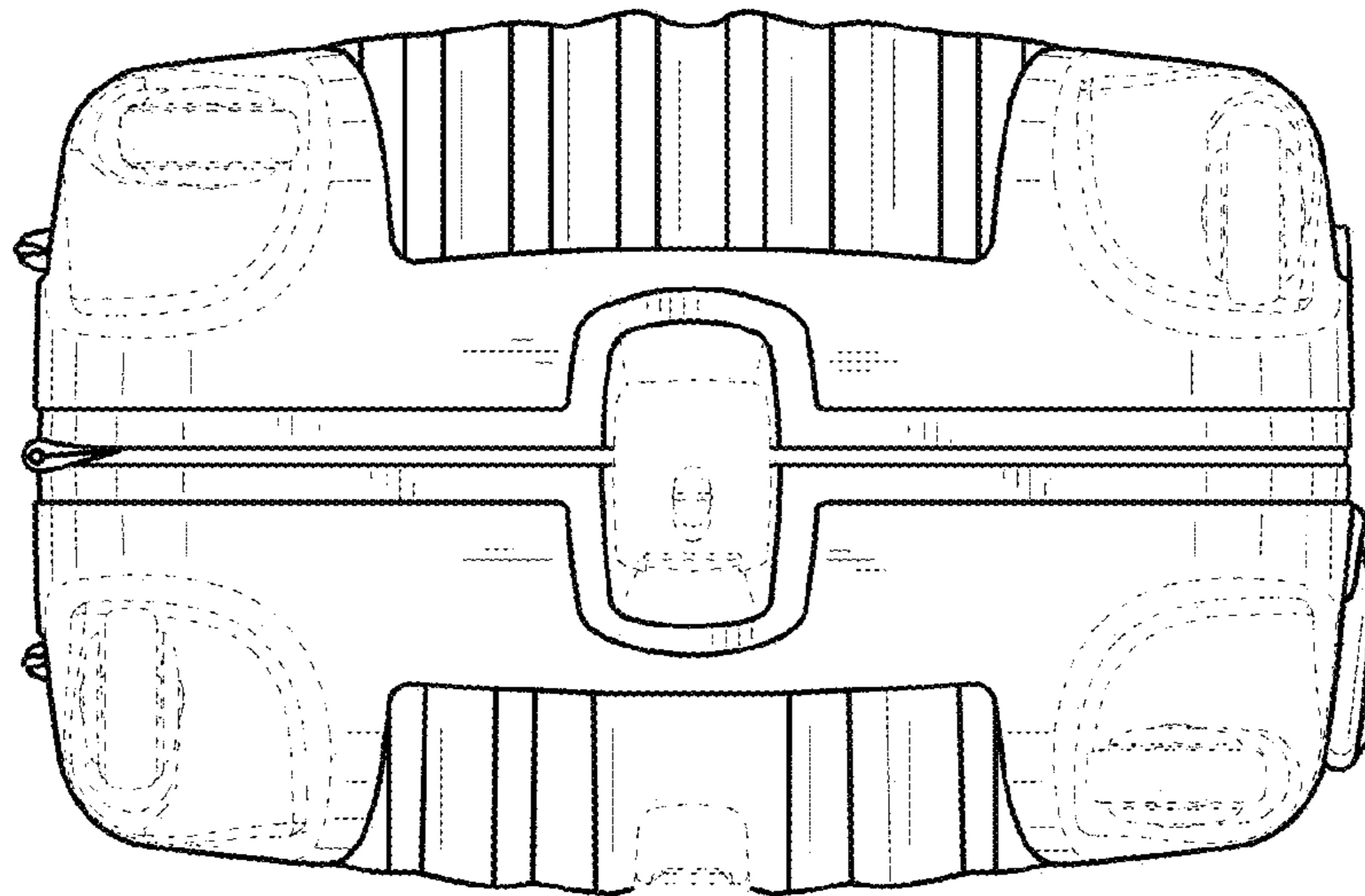

FIG. 7