



US00D733420S

(12) **United States Design Patent**
Archambeau

(10) **Patent No.:** **US D733,420 S**
(45) **Date of Patent:** **** Jul. 7, 2015**

- (54) **CARRYING BAG**
- (71) Applicant: **La Bella Couture**, Puyallup, WA (US)
- (72) Inventor: **Kim Archambeau**, Puyallup, WA (US)
- (73) Assignee: **La Bella Couture**, Puyallup, WA (US)
- (**) Term: **14 Years**
- (21) Appl. No.: **29/471,061**
- (22) Filed: **Oct. 28, 2013**

- D545,056 S 6/2007 Leighton
- D560,351 S 1/2008 Boehm et al.
- D596,858 S 7/2009 Chu et al.
- D598,253 S 8/2009 Lesser
- D609,065 S 2/2010 Lown et al.
- D622,505 S 8/2010 Lown et al.
- D628,379 S 12/2010 Guyon et al.

(Continued)

Primary Examiner — Kelley Donnelly
(74) *Attorney, Agent, or Firm* — Barry L. Davison; Davis Wright Tremaine LLP

Related U.S. Application Data

- (62) Division of application No. 29/382,916, filed on Jan. 10, 2011, now Pat. No. Des. 692,229.
- (51) **LOC (10) Cl.** **03-01**
- (52) **U.S. Cl.**
USPC **D3/217**
- (58) **Field of Classification Search**
USPC D3/216–217, 221, 254, 273, 276, 287,
D3/289, 293, 301, 900; 224/153, 257, 259;
190/112, 115, 900, 903
CPC A45C 1/024; A45C 3/001
See application file for complete search history.

(57) **CLAIM**

The ornamental design for a carrying bag, as shown and described.

DESCRIPTION

FIG. 1 is a top perspective view of a first embodiment of a carrying bag showing my new design.
 FIG. 2 is a front elevational view thereof.
 FIG. 3 is a rear elevational view thereof.
 FIG. 4 is a right side view thereof.
 FIG. 5 is a left side view thereof.
 FIG. 6 is a bottom plan view thereof.
 FIG. 7 is a top plan view thereof.
 FIG. 8 is a front perspective view thereof.
 FIG. 9 is a top perspective view of a second embodiment of a carrying bag showing my new design
 FIG. 10 is a front elevational view thereof.
 FIG. 11 is a rear elevational view thereof.
 FIG. 12 is a right side view thereof.
 FIG. 13 is a left side view thereof.
 FIG. 14 is a bottom plan view thereof,
 FIG. 15 is a top plan view thereof; and,
 FIG. 16 is a front perspective view thereof.
 The broken lines are for the purposes of illustrating the environment of the design only and form no part of the claimed design.
 The dash-dot lines represent boundaries and form no part thereof.

(56) **References Cited**

U.S. PATENT DOCUMENTS

- D402,804 S 12/1998 Ramirez
- D412,787 S 8/1999 Young
- D431,755 S 10/2000 Worley et al.
- D431,967 S 10/2000 Worley et al.
- 6,779,638 B2 * 8/2004 Renz et al. 190/111
- D503,278 S * 3/2005 Jones D3/237
- D506,434 S 6/2005 Ling
- D507,107 S 7/2005 Goldberg
- D510,660 S * 10/2005 Suppangig D3/246
- D517,321 S 3/2006 Wilde et al.
- D526,120 S * 8/2006 Lee et al. D3/233
- D530,089 S 10/2006 Silverman
- D543,027 S * 5/2007 Wang D3/246

1 Claim, 10 Drawing Sheets

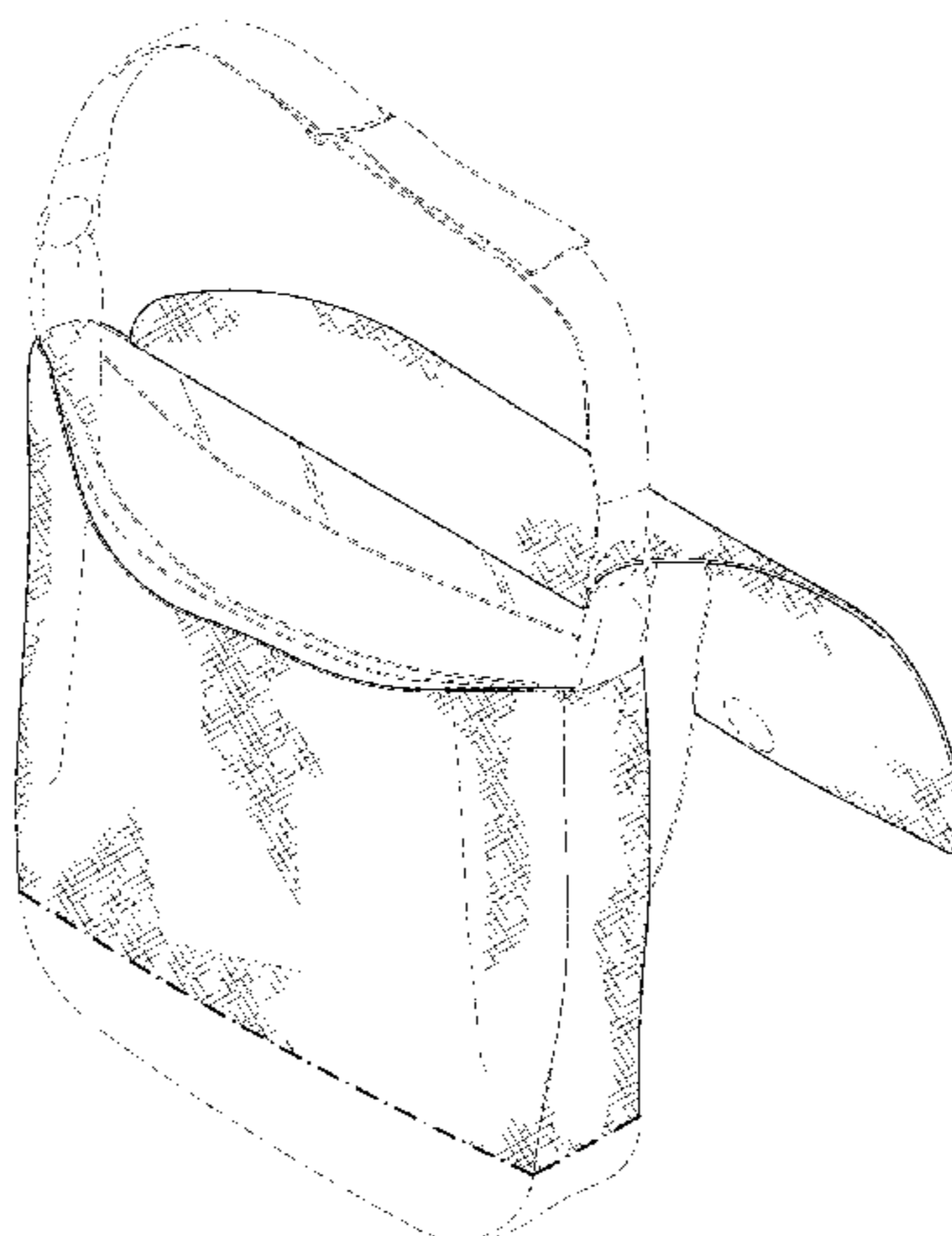

(56)

References Cited

U.S. PATENT DOCUMENTS

D639,063 S 6/2011 Benoit
D641,554 S 7/2011 Martinetti
D651,794 S * 1/2012 Hargens et al. D3/232
D657,140 S * 4/2012 Guyon et al. D3/243

D668,456 S 10/2012 Du
D692,229 S 10/2013 Archambeau
D717,043 S * 11/2014 Pulliam et al. D3/243
D722,228 S * 2/2015 Zwetzig D3/232
D722,766 S * 2/2015 Philo D3/243
D724,317 S * 3/2015 Proteau D3/232
2009/0194209 A1 8/2009 De Filippis et al.

* cited by examiner

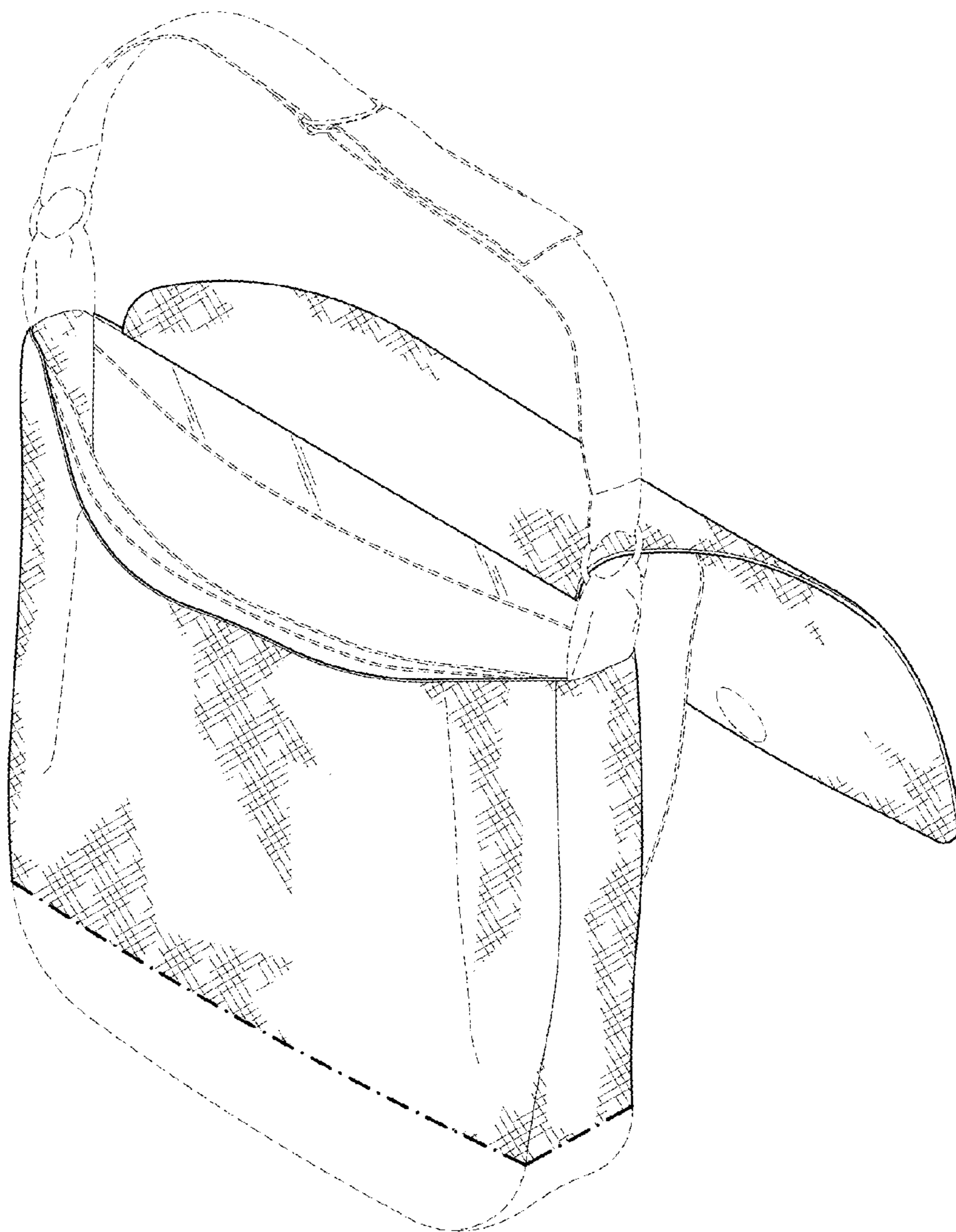

Fig. 1

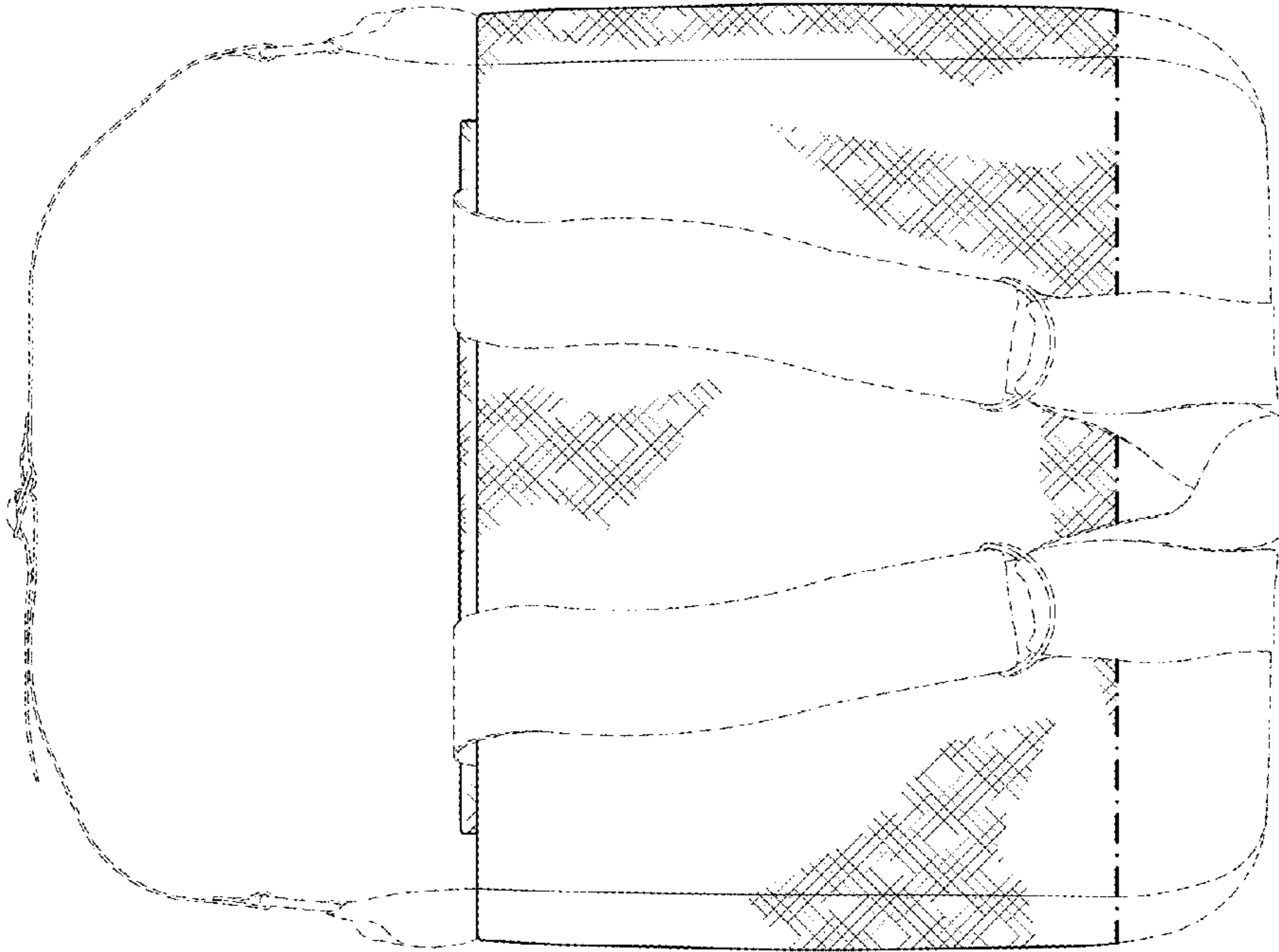

Fig. 2

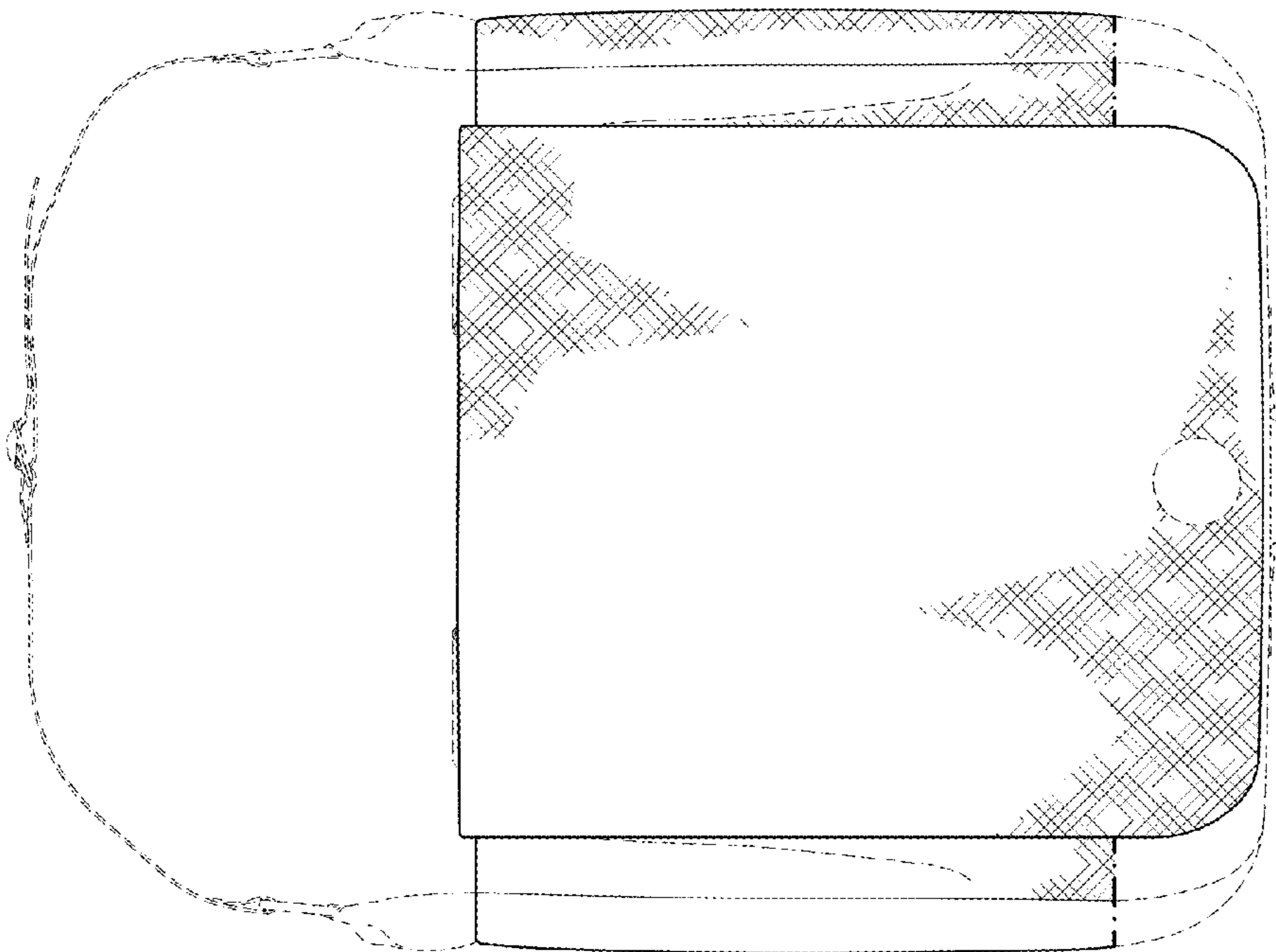

Fig. 3

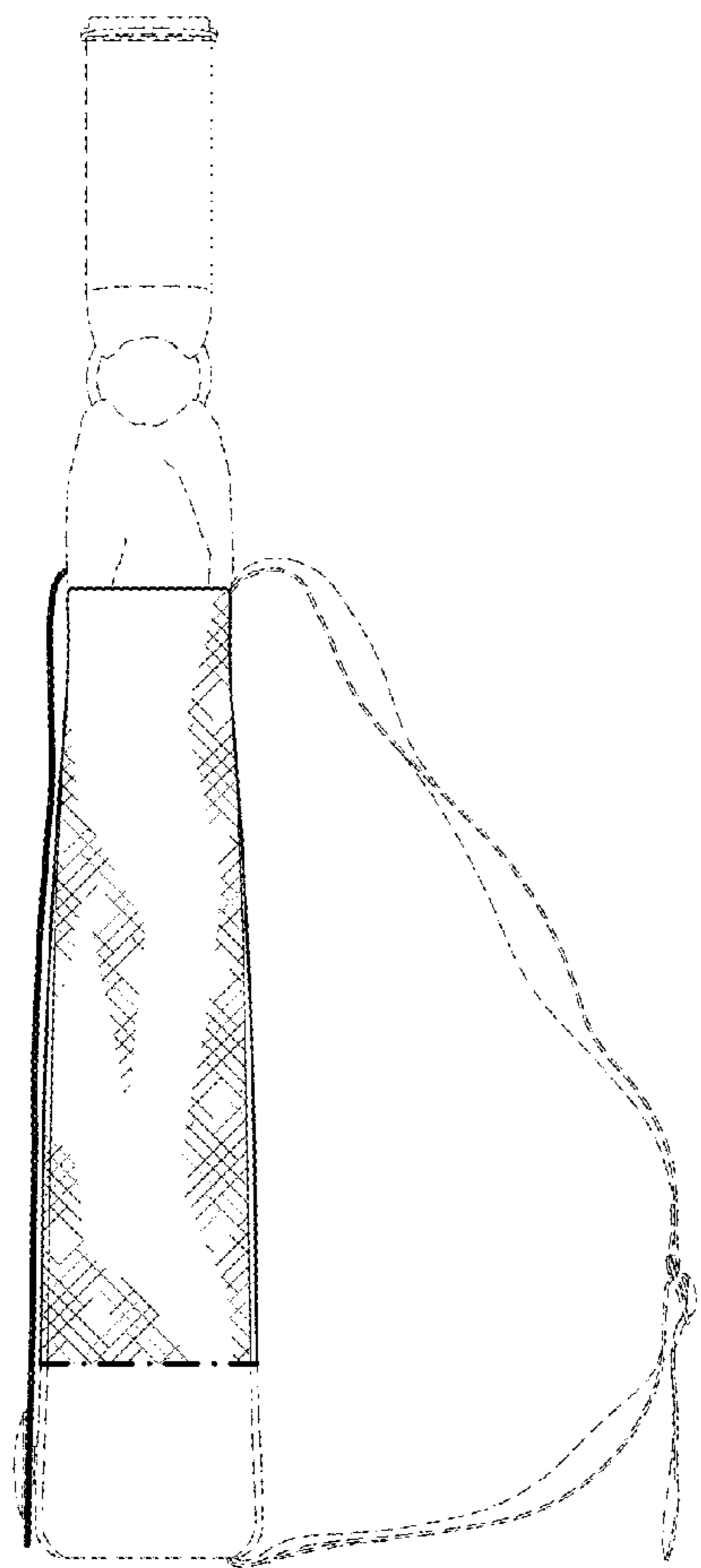

Fig. 4

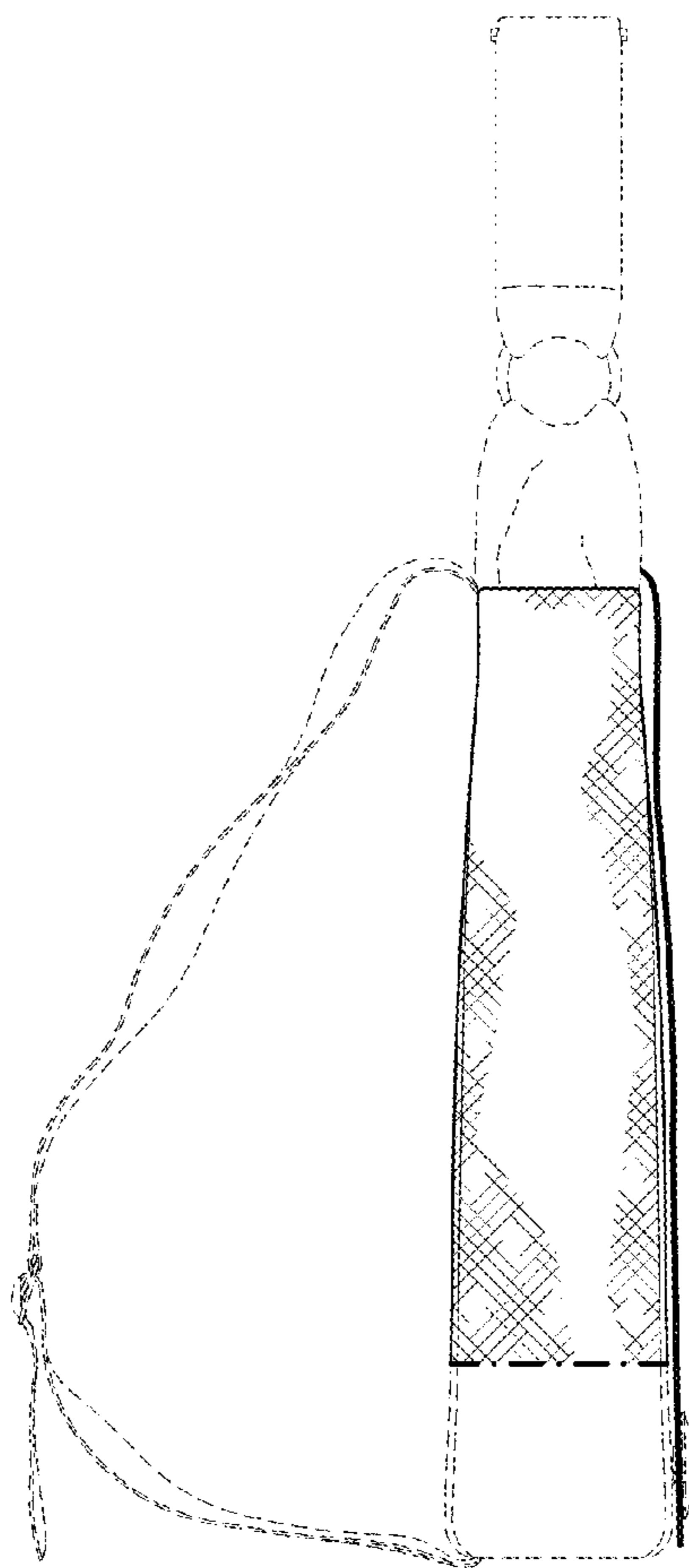

Fig. 5

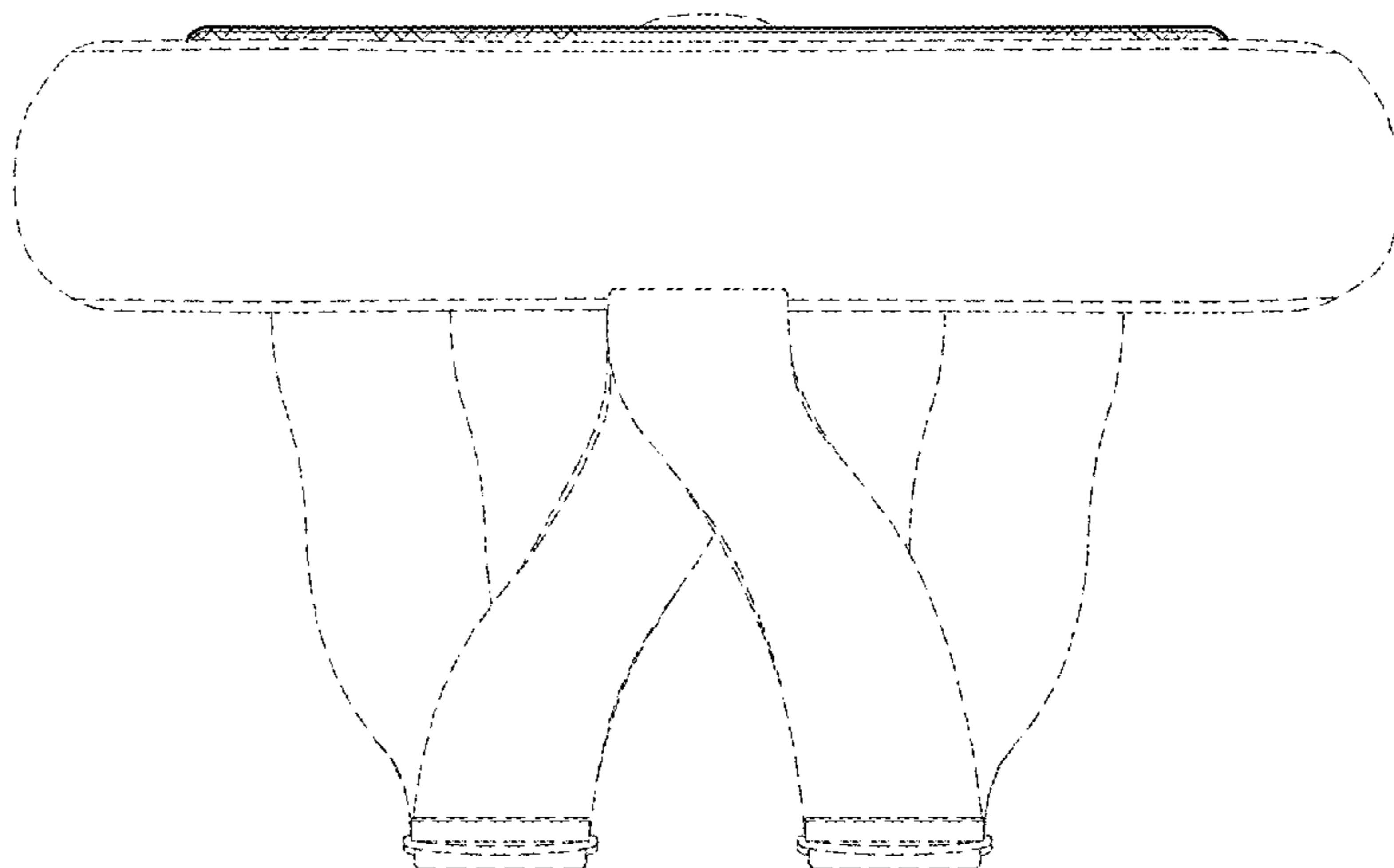

Fig. 6

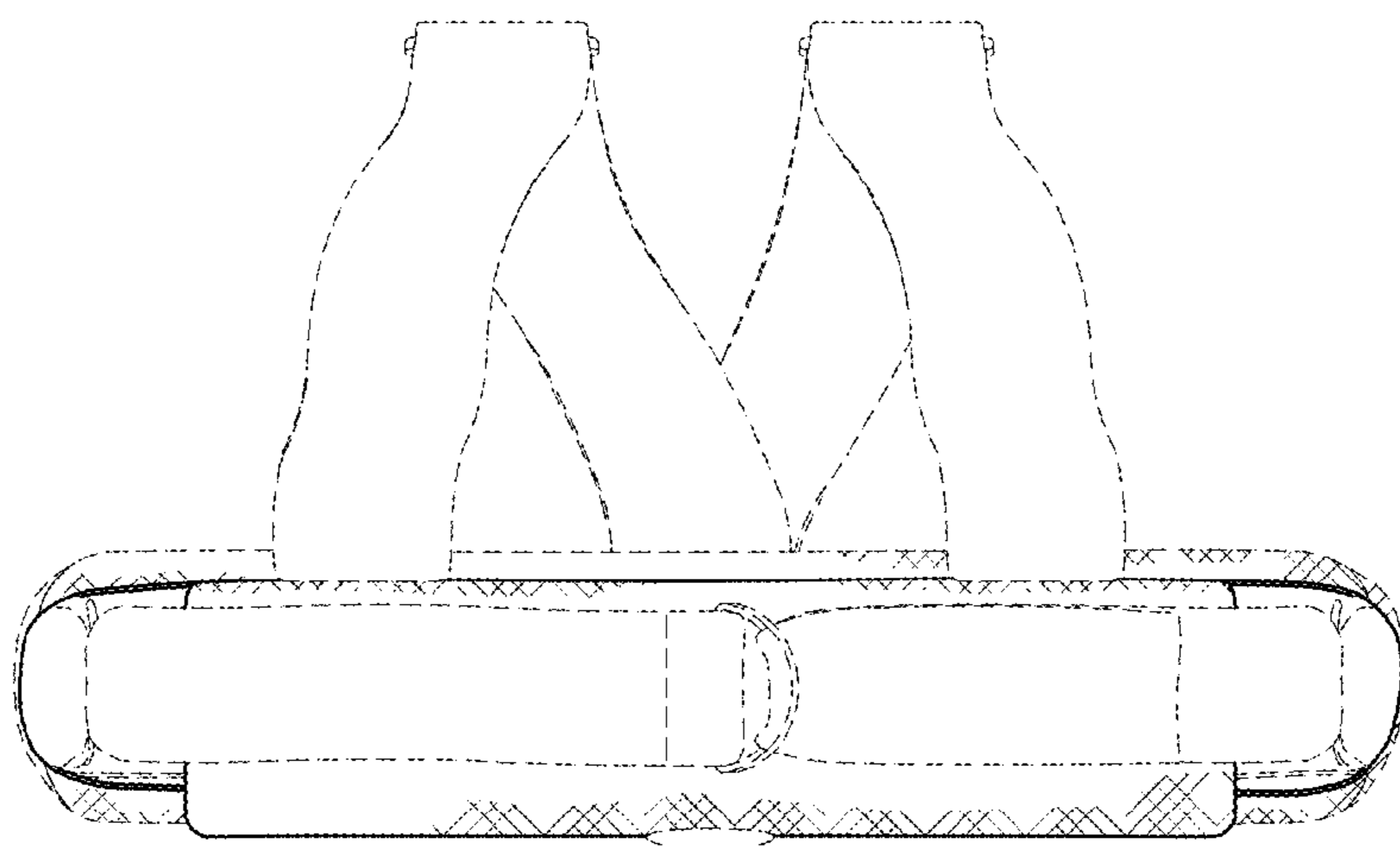

Fig. 7

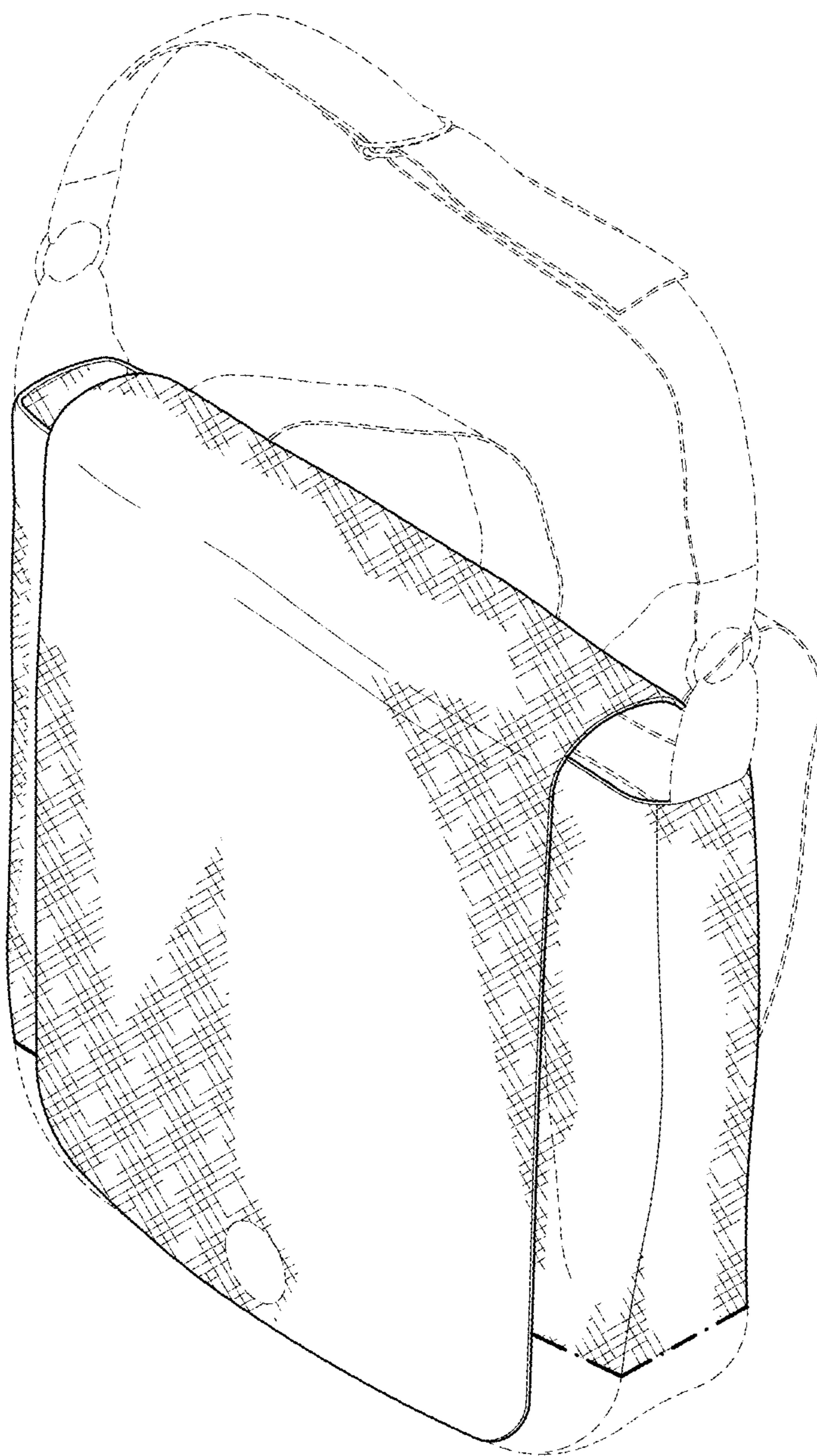

Fig. 8

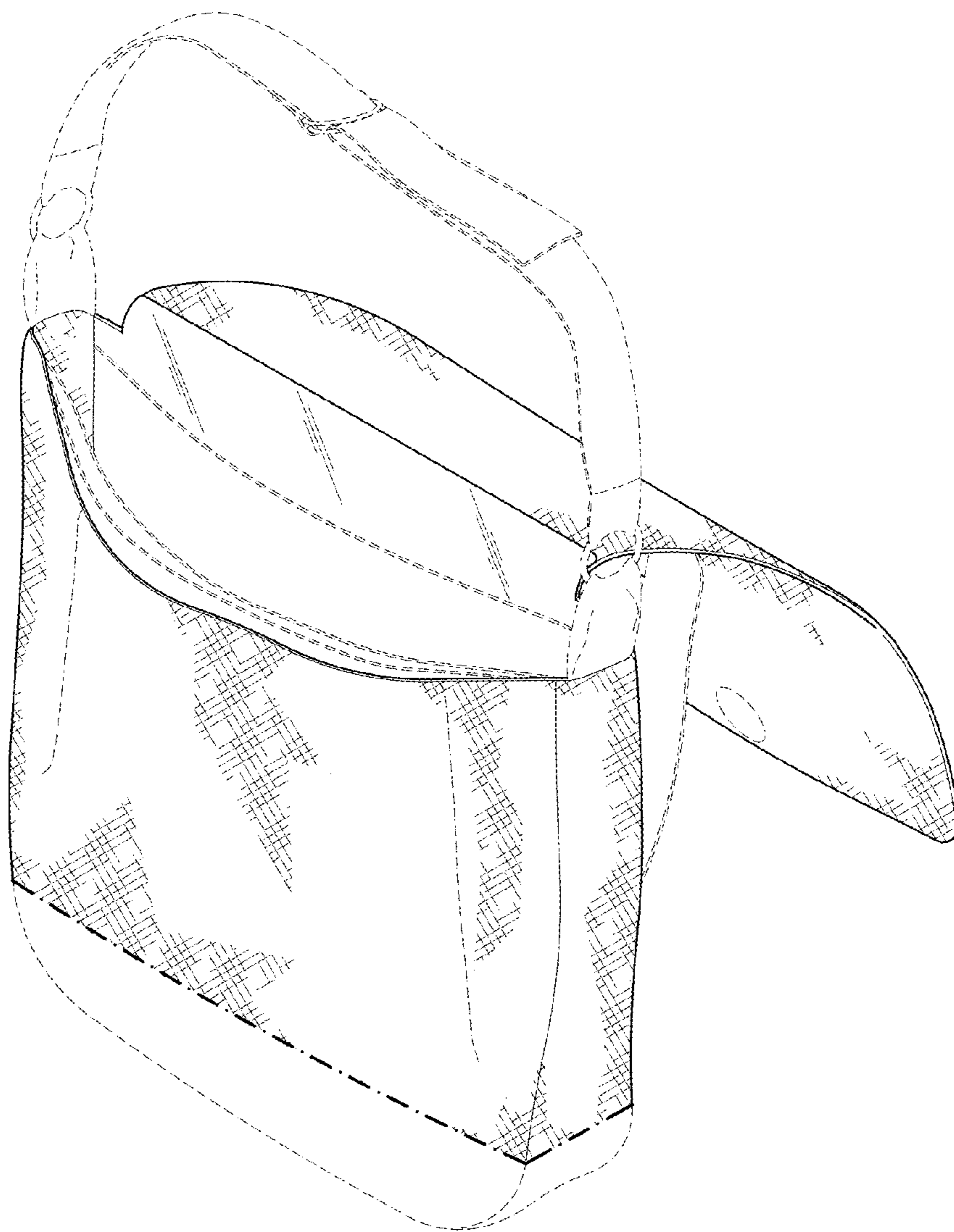

Fig. 9

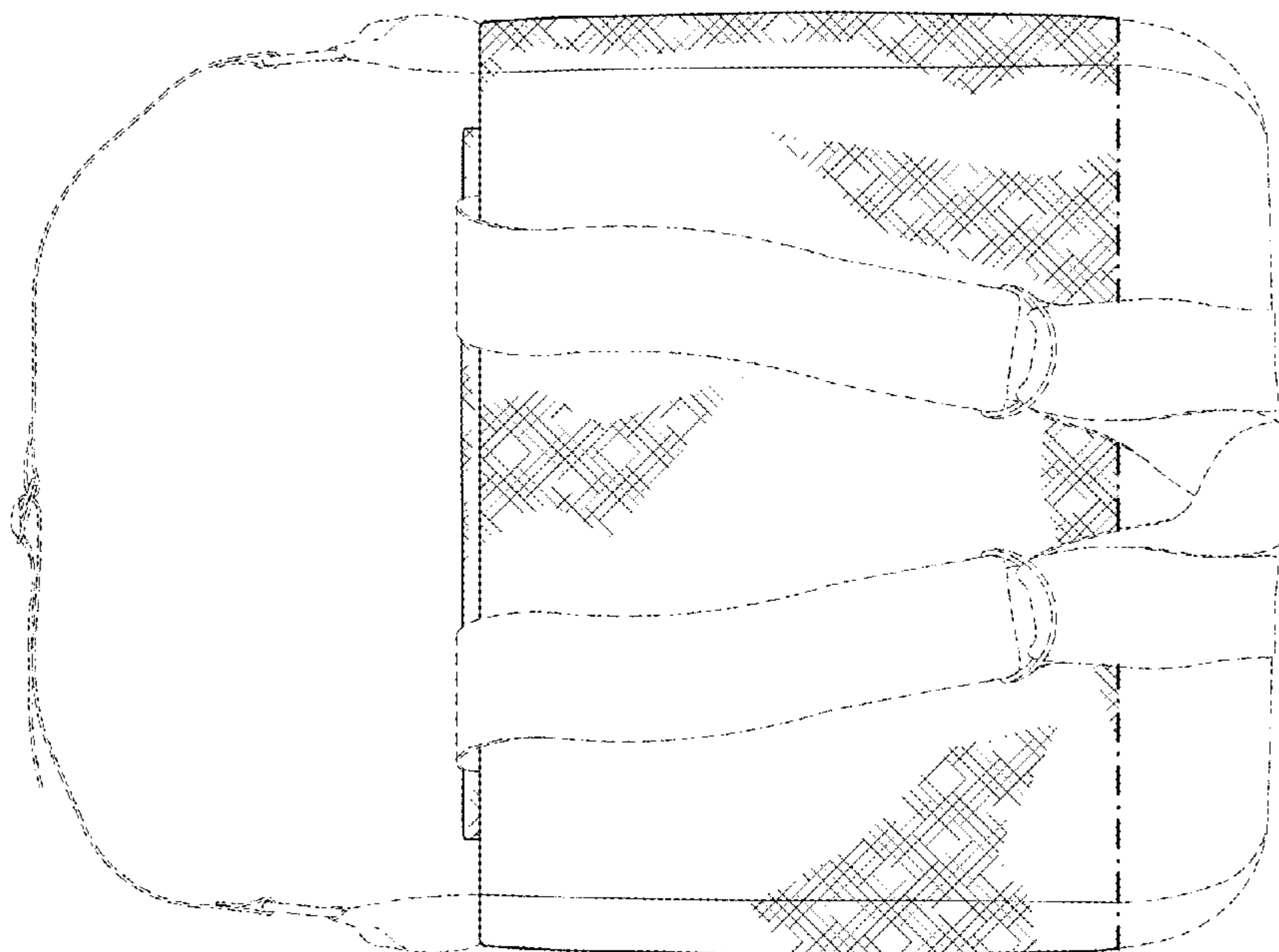

Fig. 11

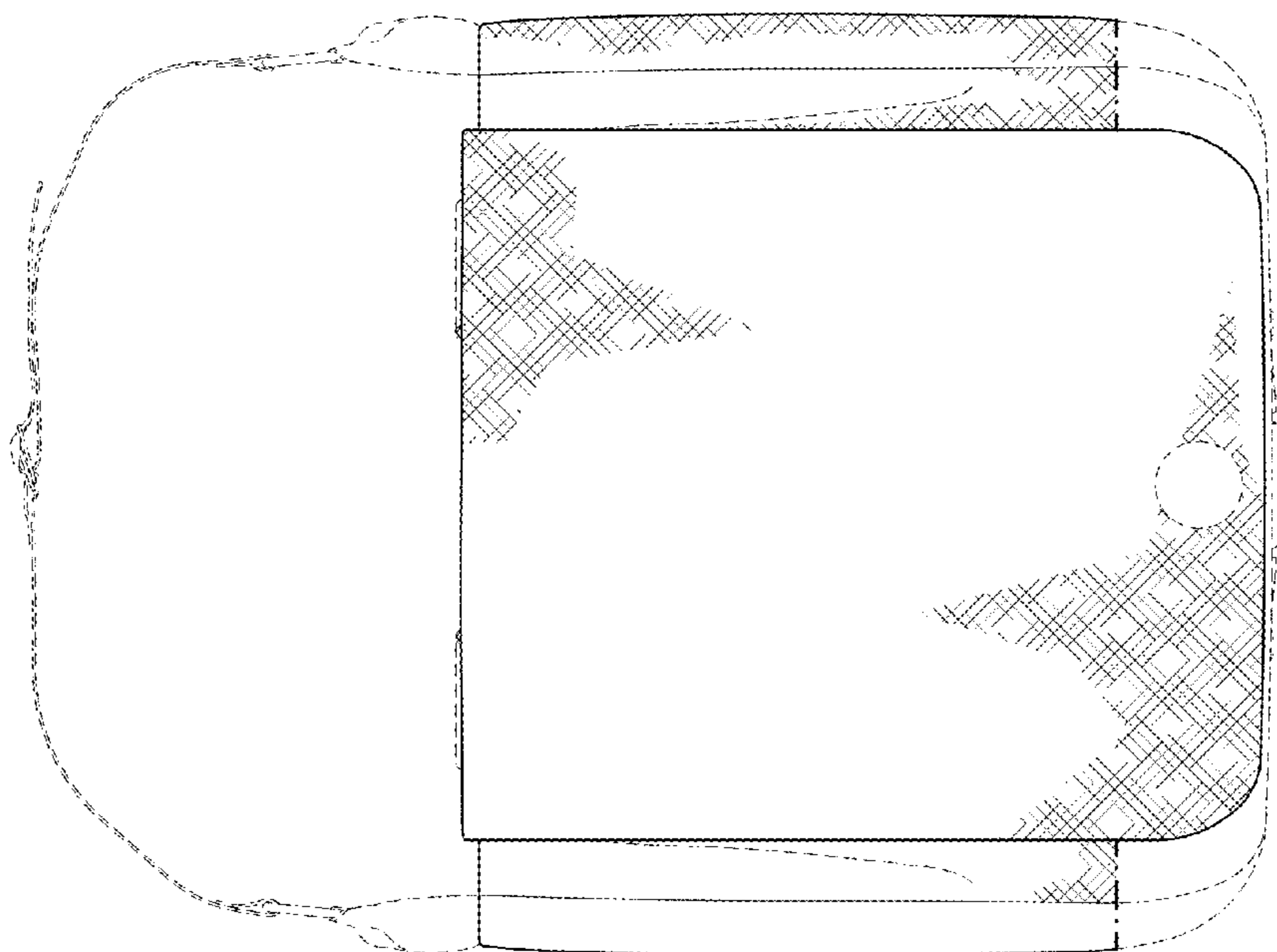

Fig. 10

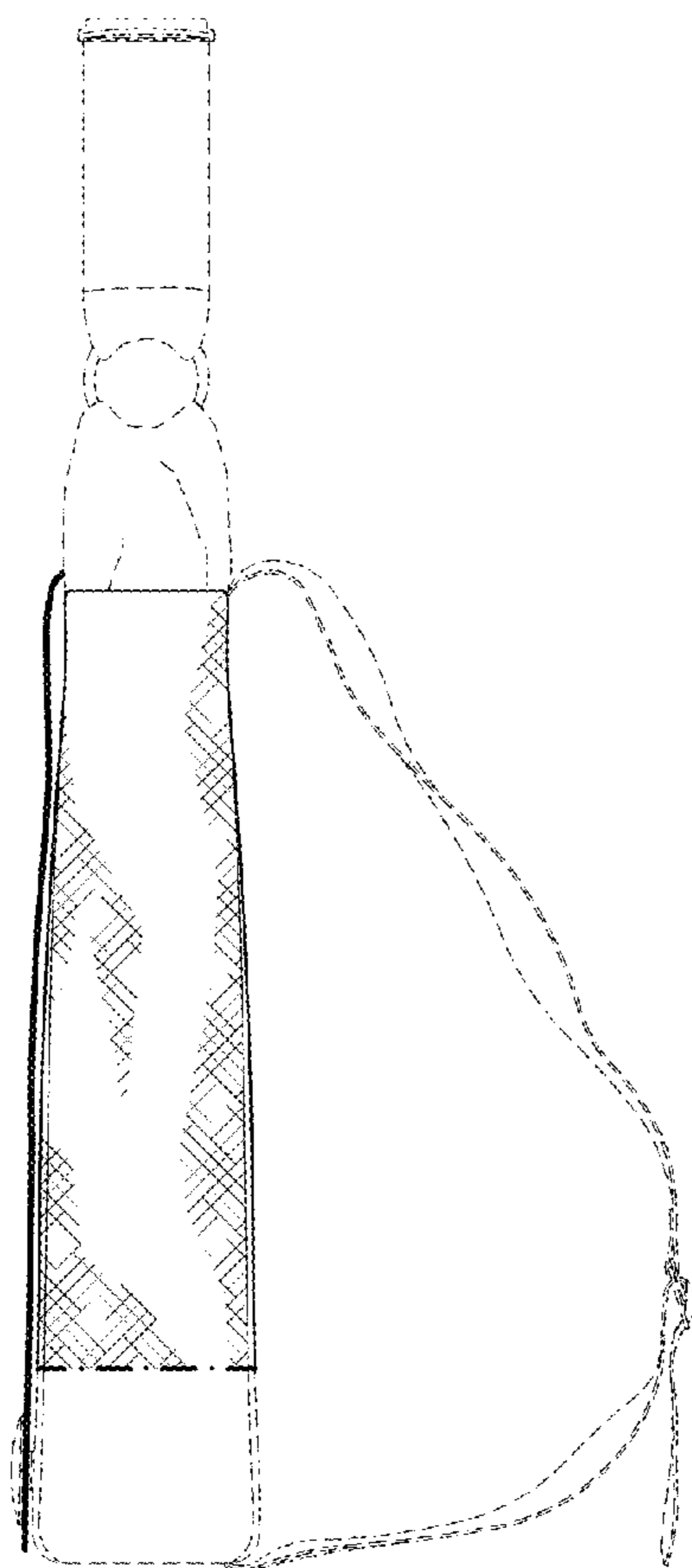

Fig. 12

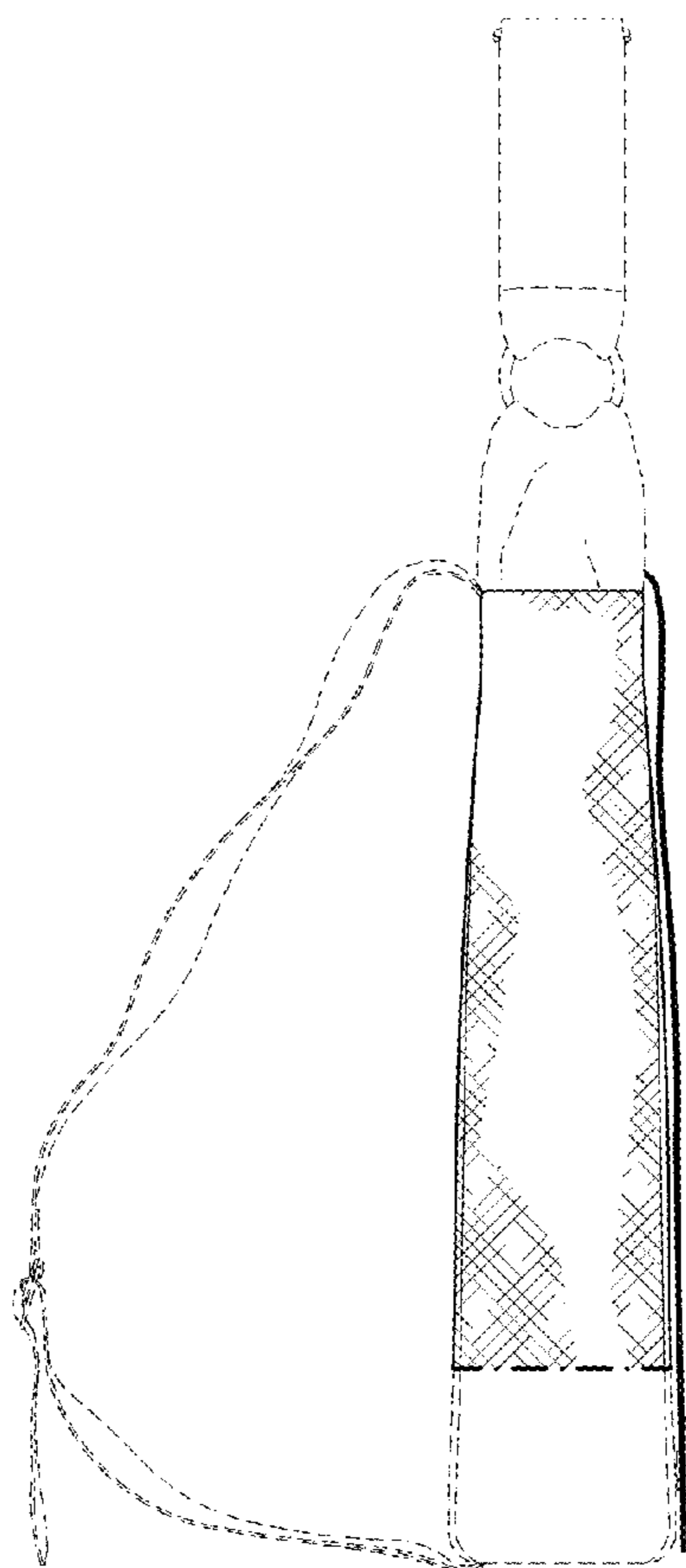

Fig. 13

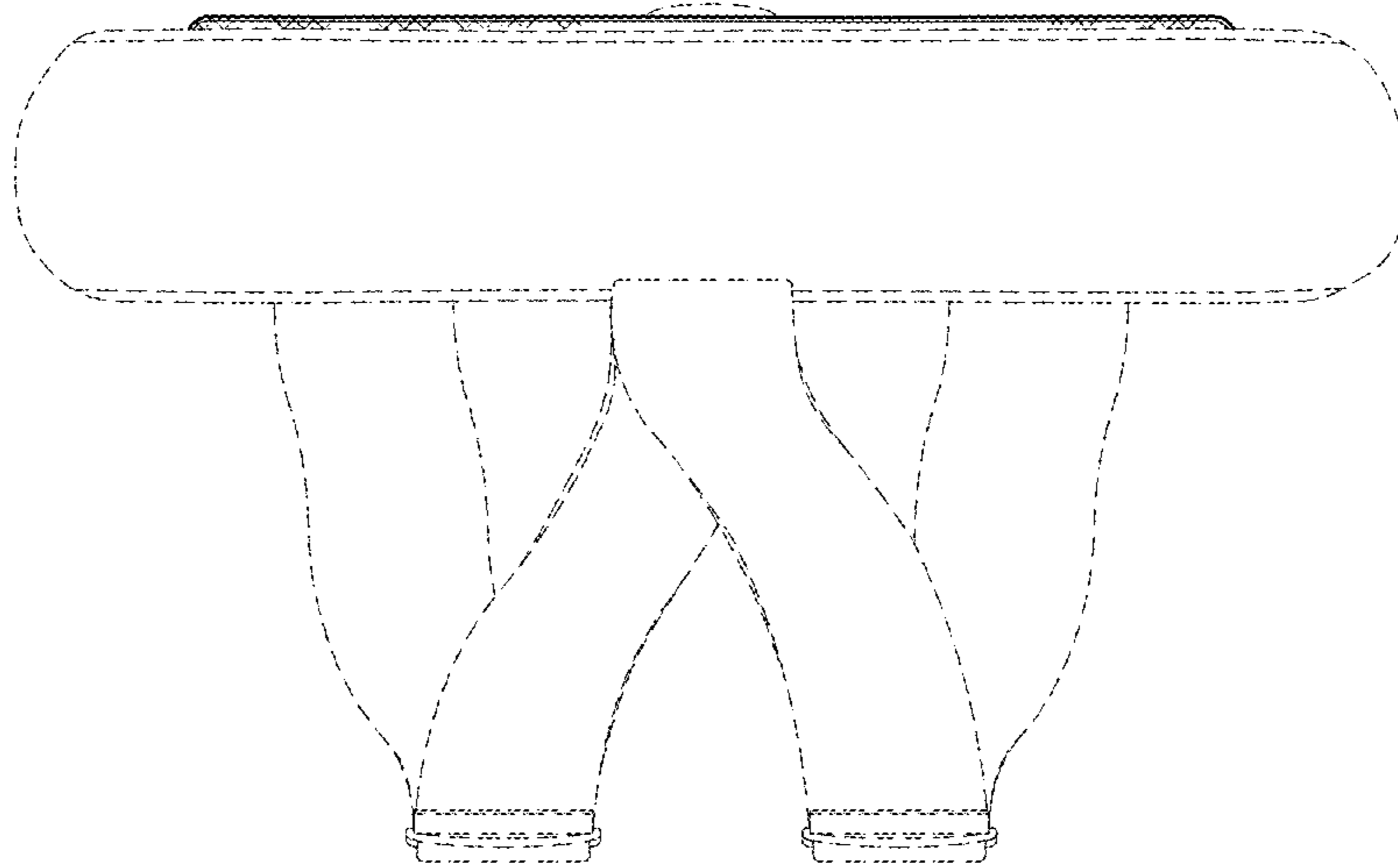

Fig. 14

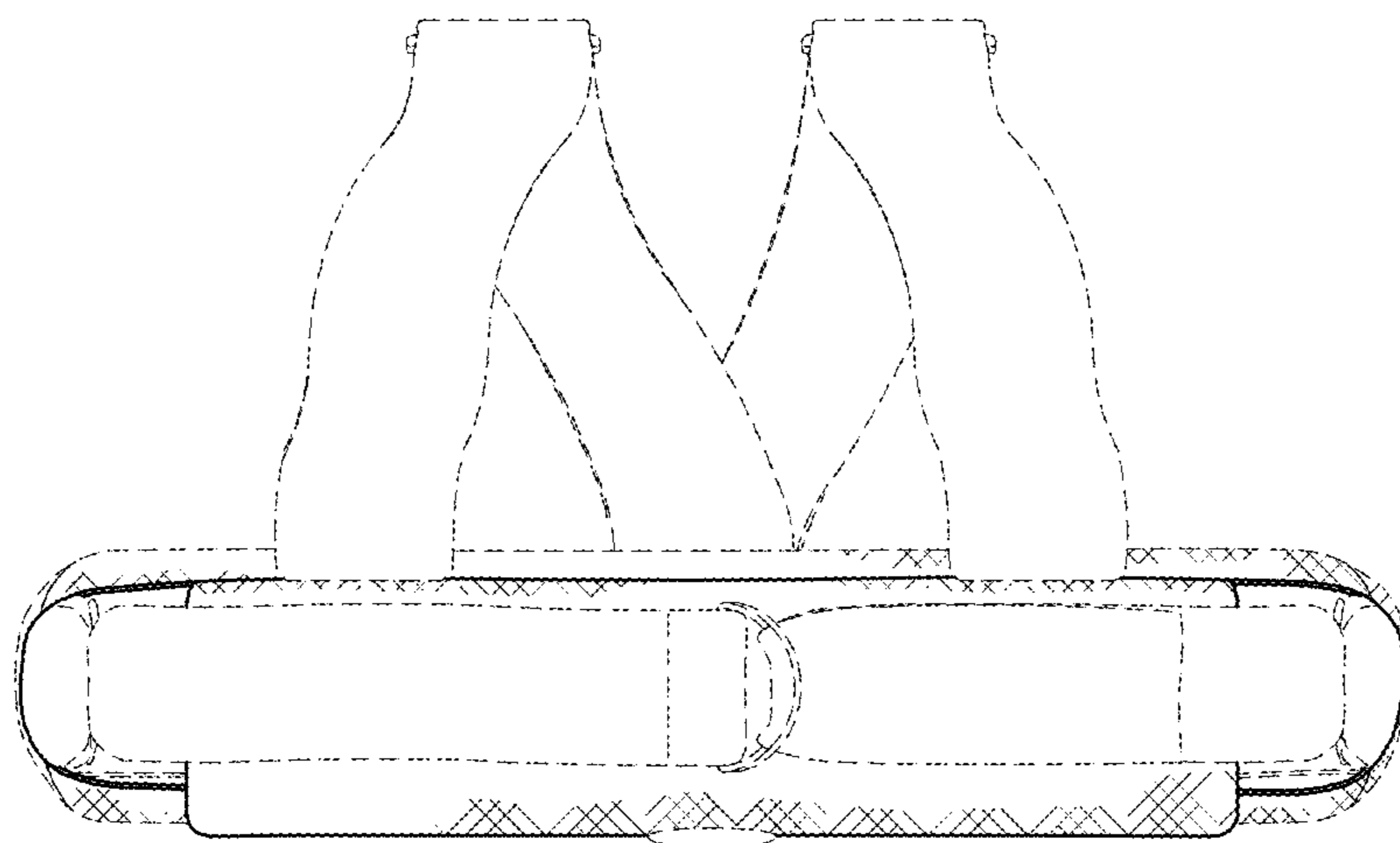

Fig. 15

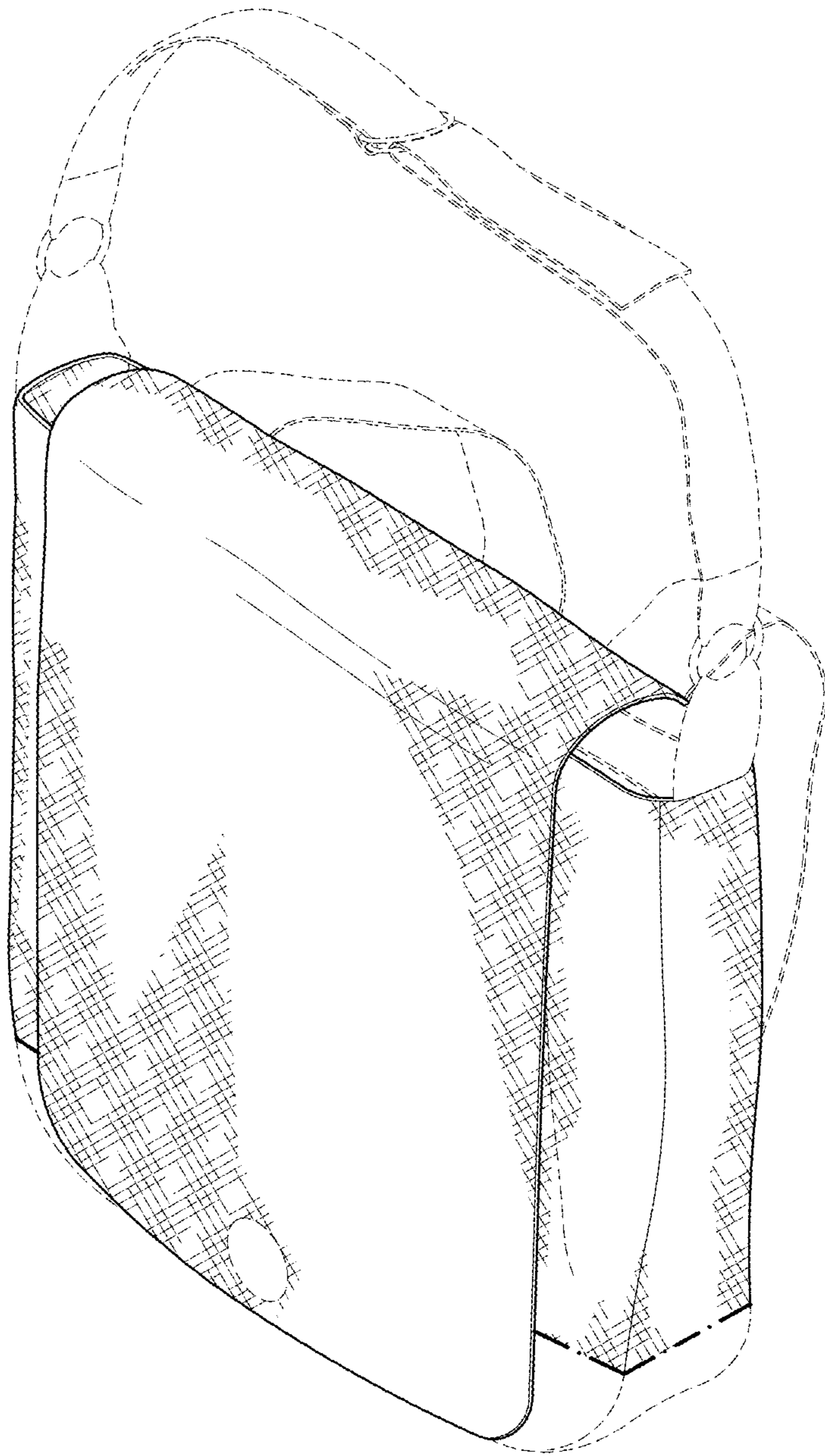

Fig. 16