

US00D733418S

(12) **United States Design Patent**
Horn

(10) **Patent No.:** **US D733,418 S**

(45) **Date of Patent:** **** Jul. 7, 2015**

(54) **PILL BOTTLE WITH INDICIA AND WRITING INSTRUMENT HOLDER**

Primary Examiner — Catheri Oliver-Garcia

(74) *Attorney, Agent, or Firm* — James Ray & Assoc

(71) Applicant: **Kimberlee Ann Horn**, Romney, IN (US)

(57) **CLAIM**

The ornamental design for a pill bottle with indicia and writing instrument holder, as shown.

(72) Inventor: **Kimberlee Ann Horn**, Romney, IN (US)

(**) Term: **14 Years**

DESCRIPTION

(21) Appl. No.: **29/444,255**

FIG. 1 is a perspective view of a pill bottle showing my new design.

(22) Filed: **Jan. 29, 2013**

FIG. 2 is a front perspective view of another embodiment thereof.

(51) **LOC (10) Cl.** **03-01**

(52) **U.S. Cl.**

USPC **D3/203.2**

(58) **Field of Classification Search**

USPC D3/201–205; D9/516, 519, 522, 529, D9/537, 545; 206/528–540

CPC A61J 1/00; A61J 3/07; A61J 1/03; A61J 1/1412; A61J 2001/1418; A61J 2001/1425

See application file for complete search history.

FIG. 3 is a bottom plan view of the pill bottle in FIG. 1.

FIG. 4 is a top plan view of the pill bottle in FIG. 1.

FIG. 5 is a top plan view of the pill bottle in FIG. 2.

FIG. 6 is a bottom plan view of the pill bottle in FIG. 2.

FIG. 7 is a left side elevation view of the pill bottle in FIG. 1.

FIG. 8 is a front elevation view of the pill bottle in FIG. 1.

FIG. 9 is a right side elevation view of the pill bottle in FIG. 1.

FIG. 10 is a rear elevation view of the pill bottle in FIG. 1.

FIG. 11 is a left side elevation view of the pill bottle in FIG. 2.

FIG. 12 is a front elevation view of the pill bottle in FIG. 2.

FIG. 13 is a right side elevation view of the pill bottle in FIG. 2; and,

FIG. 14 is a rear elevation view of the pill bottle in FIG. 2.

The broken lines showing of the environment in the drawings is included for the purpose of illustrating only and forms no part of the claimed design.

(56) **References Cited**

U.S. PATENT DOCUMENTS

D602,369 S *	10/2009	Potts et al.	D9/547
D605,949 S *	12/2009	Potts et al.	D9/547
D680,437 S *	4/2013	Bartolo et al.	D9/540
8,490,795 B2 *	7/2013	Ziemba	206/528
D717,174 S *	11/2014	Garcia	D9/529

* cited by examiner

1 Claim, 4 Drawing Sheets

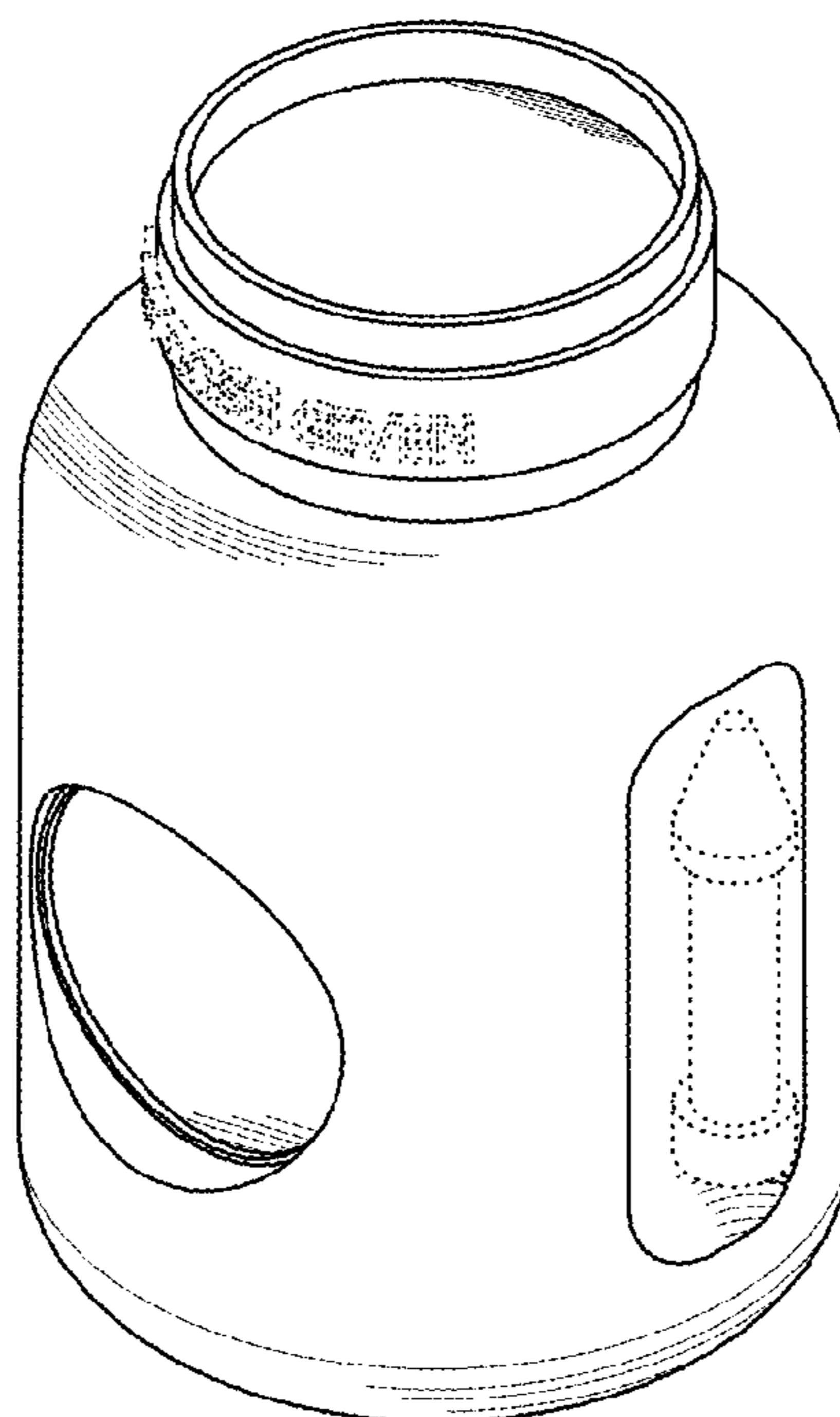

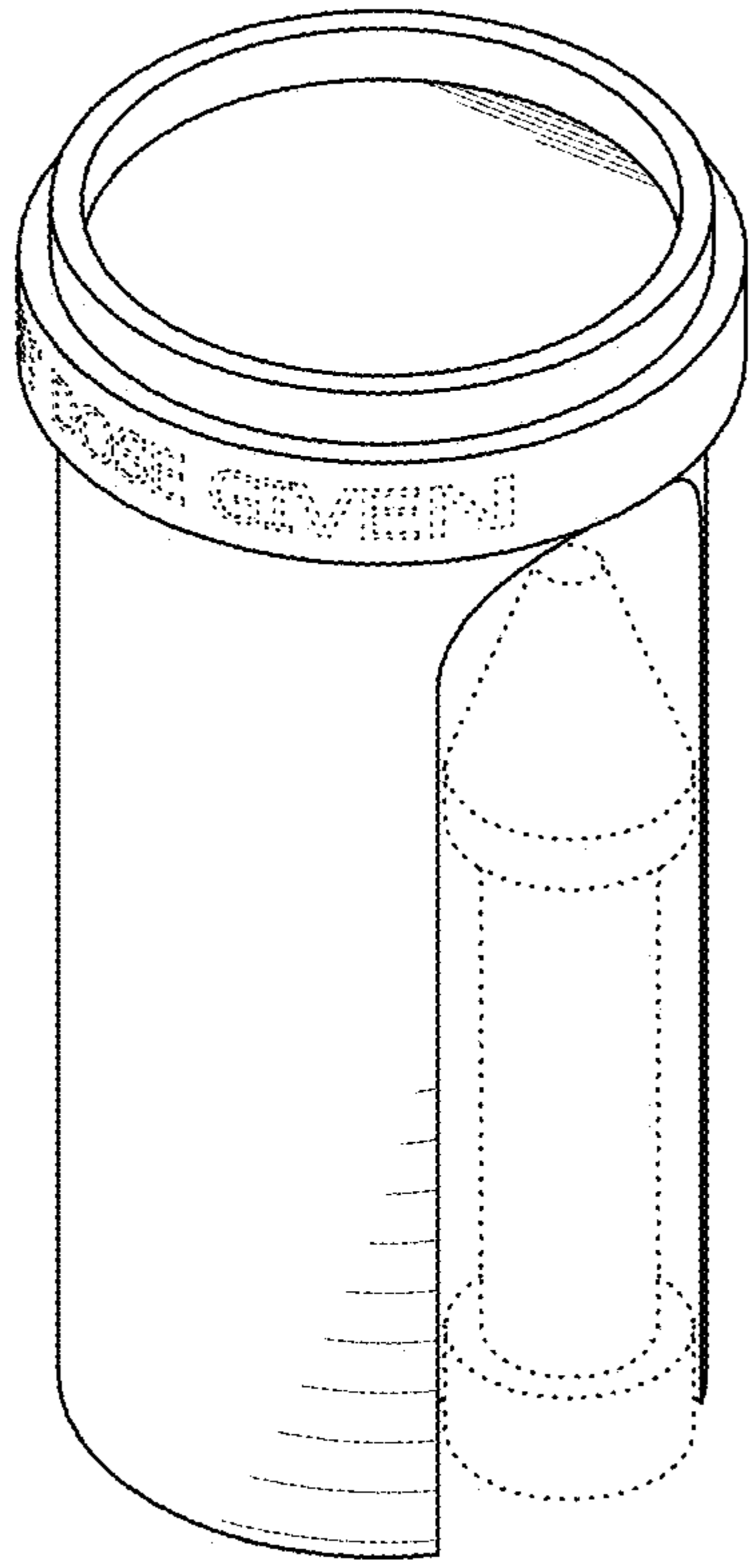

FIG. 1

FIG. 2

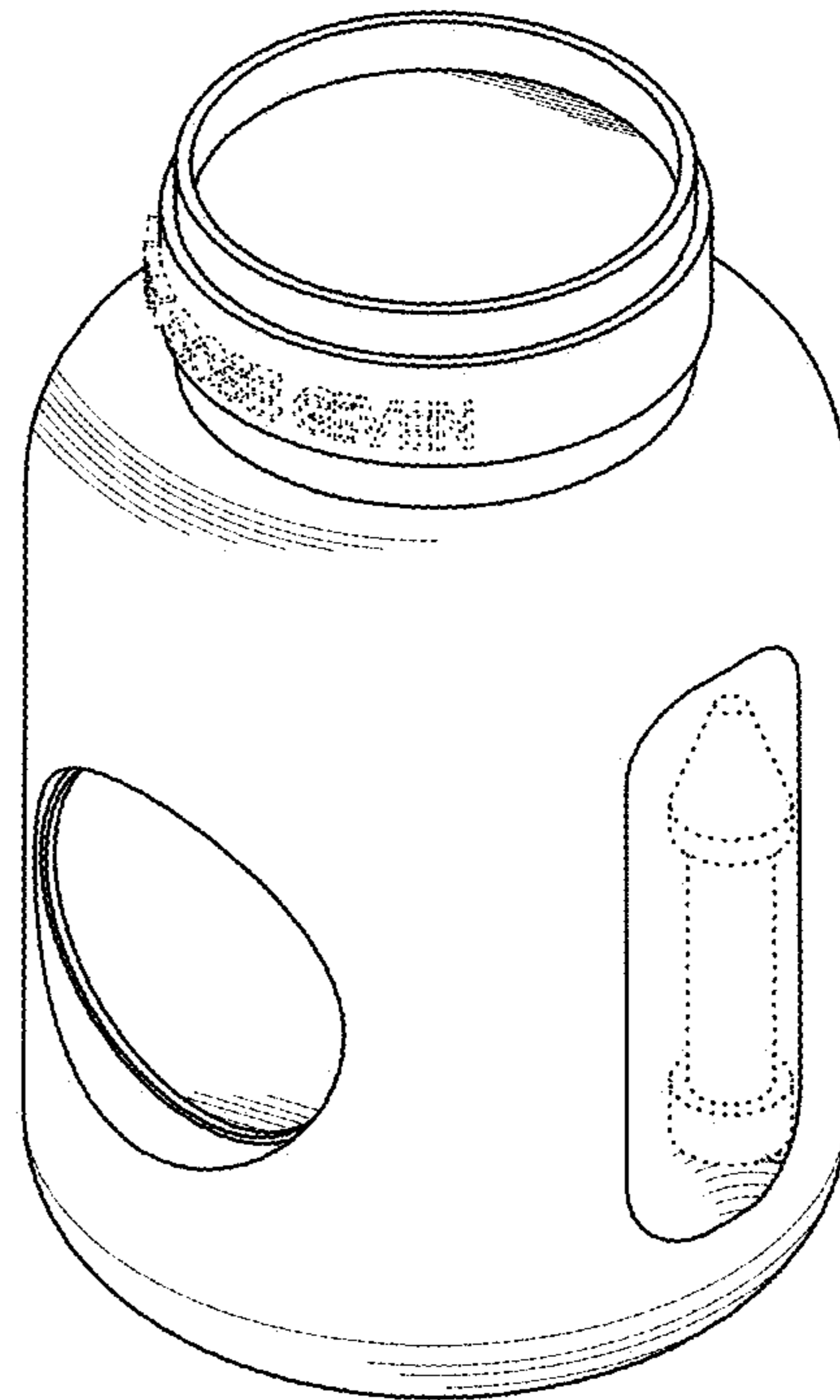

FIG. 3

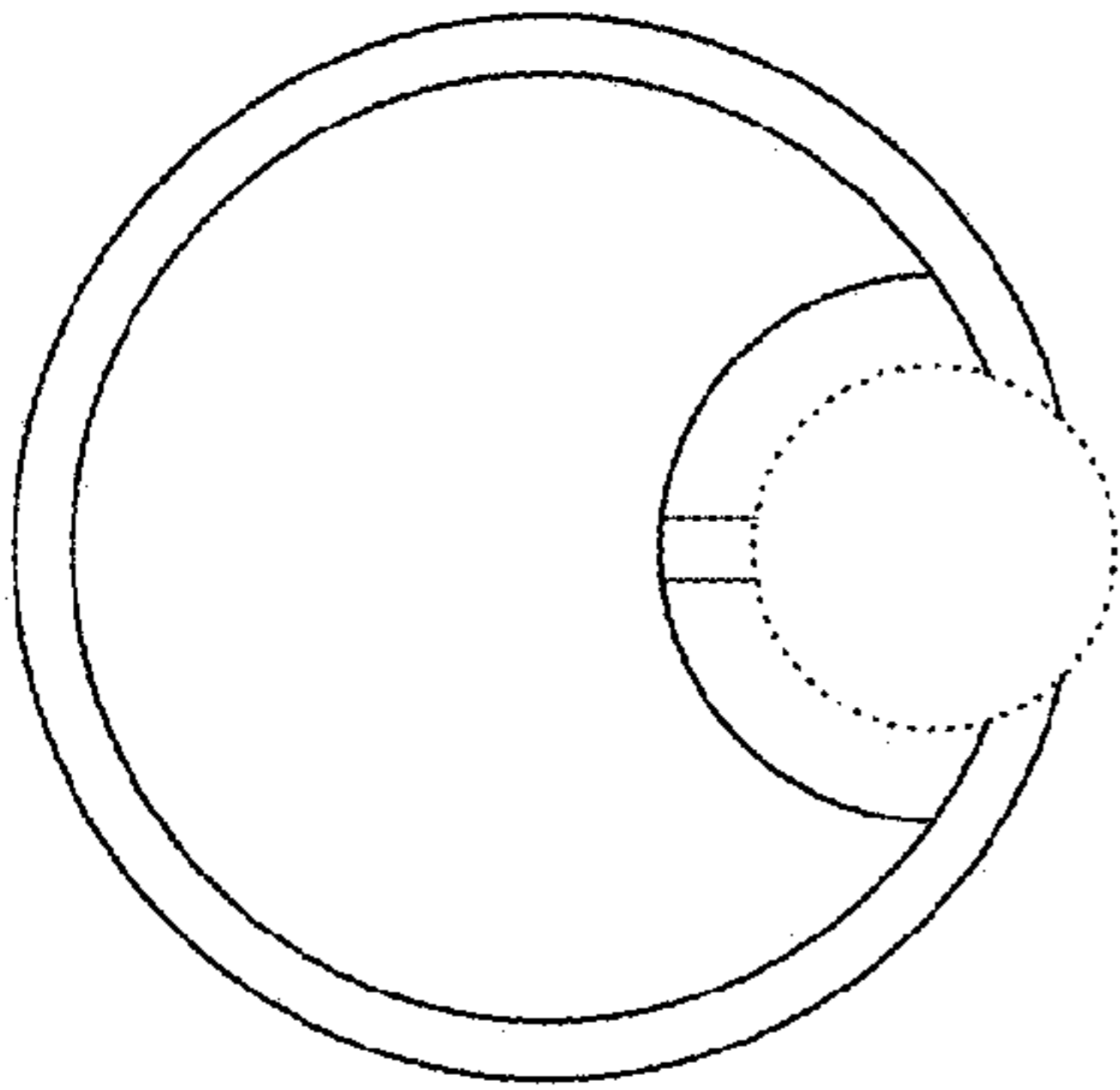

FIG. 5

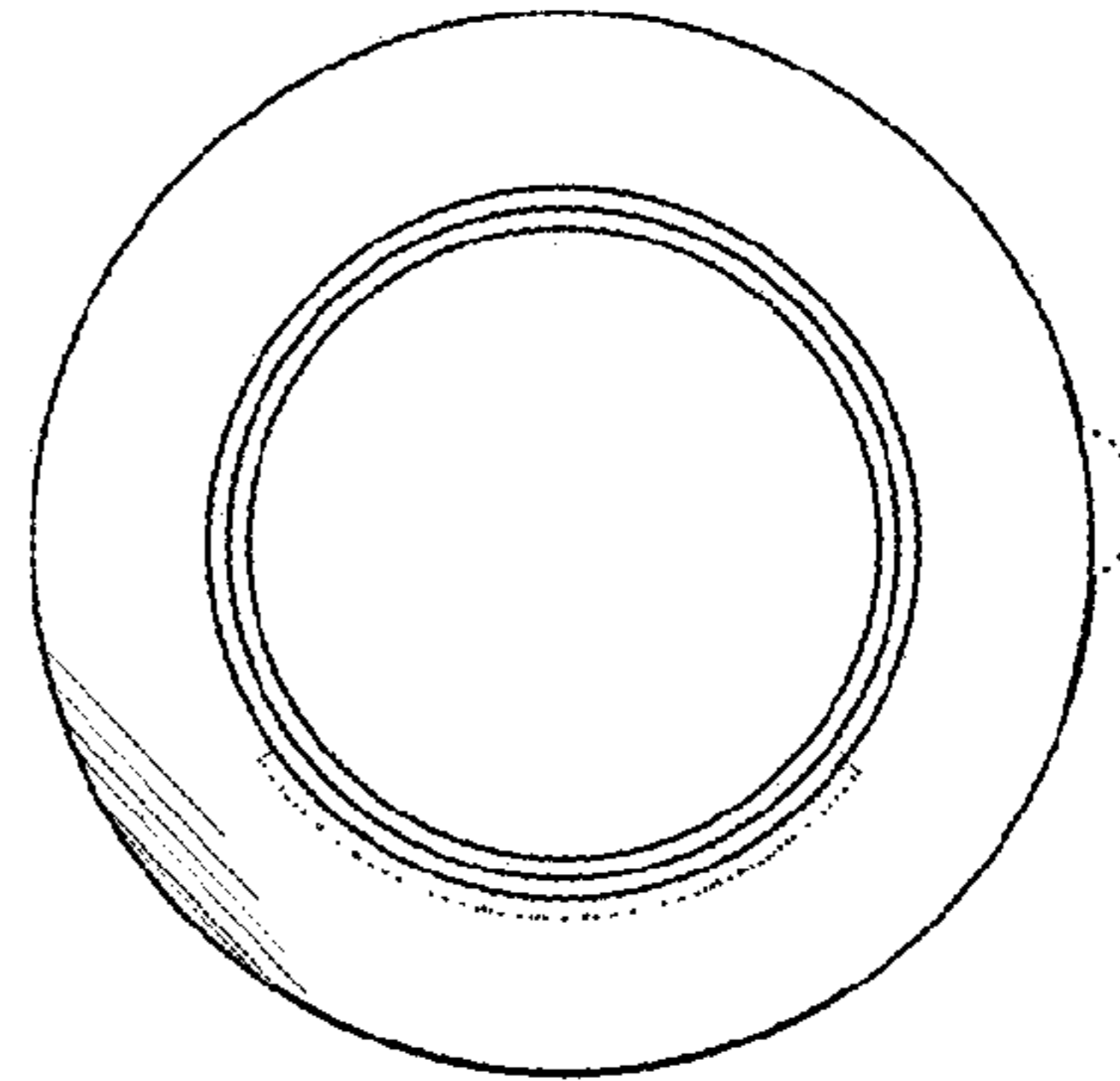

FIG. 4

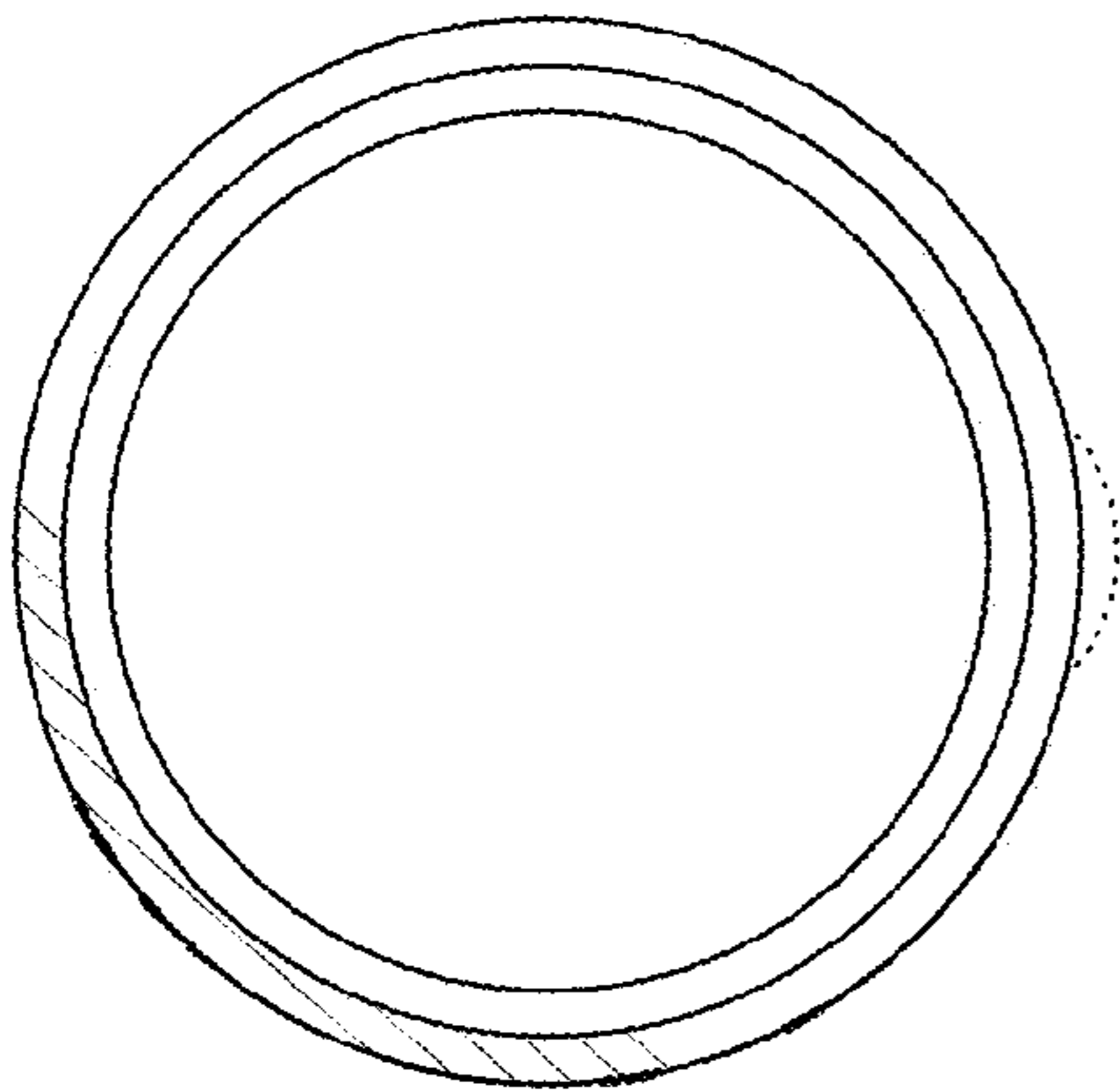

FIG. 6

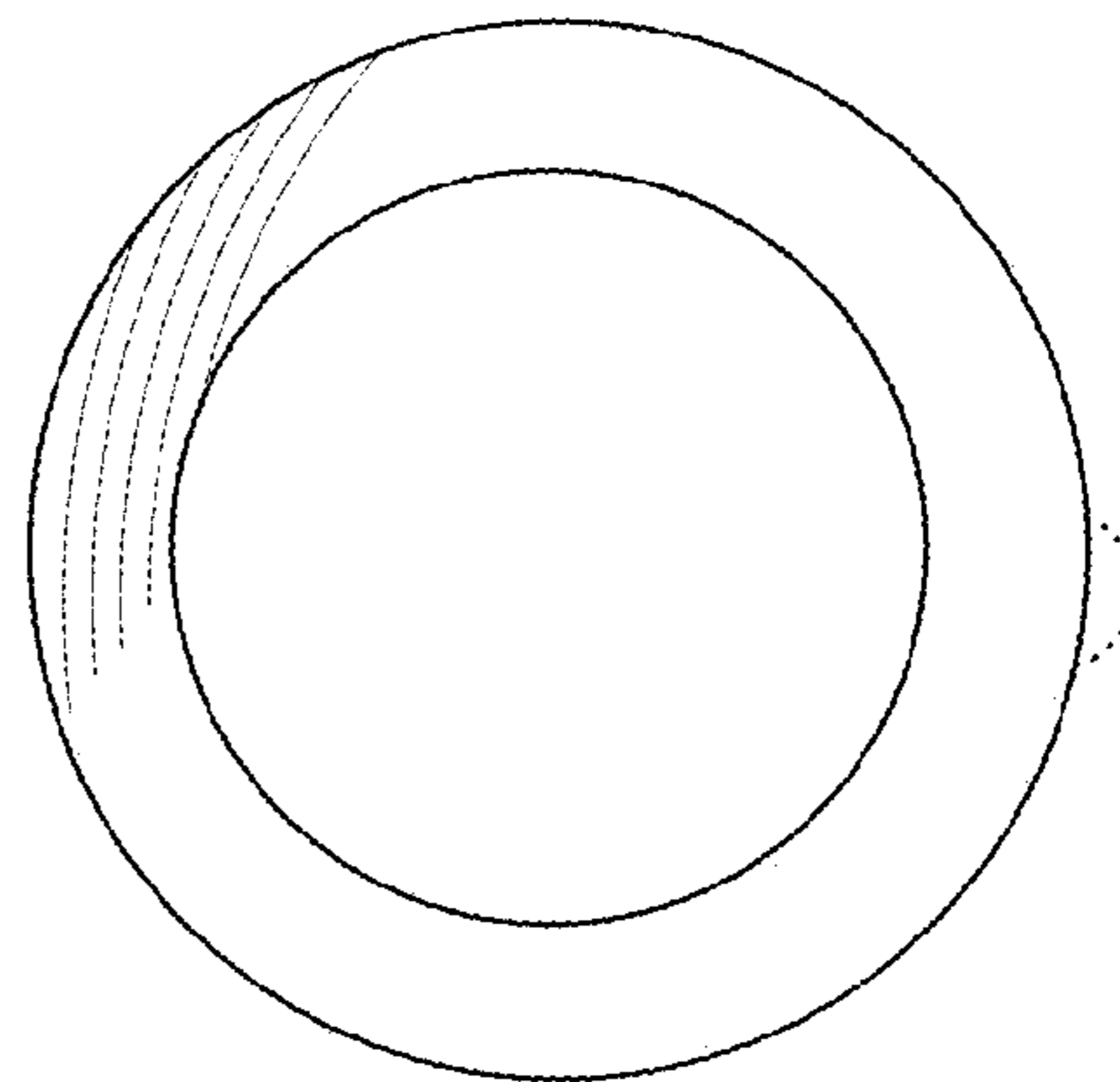

FIG. 7

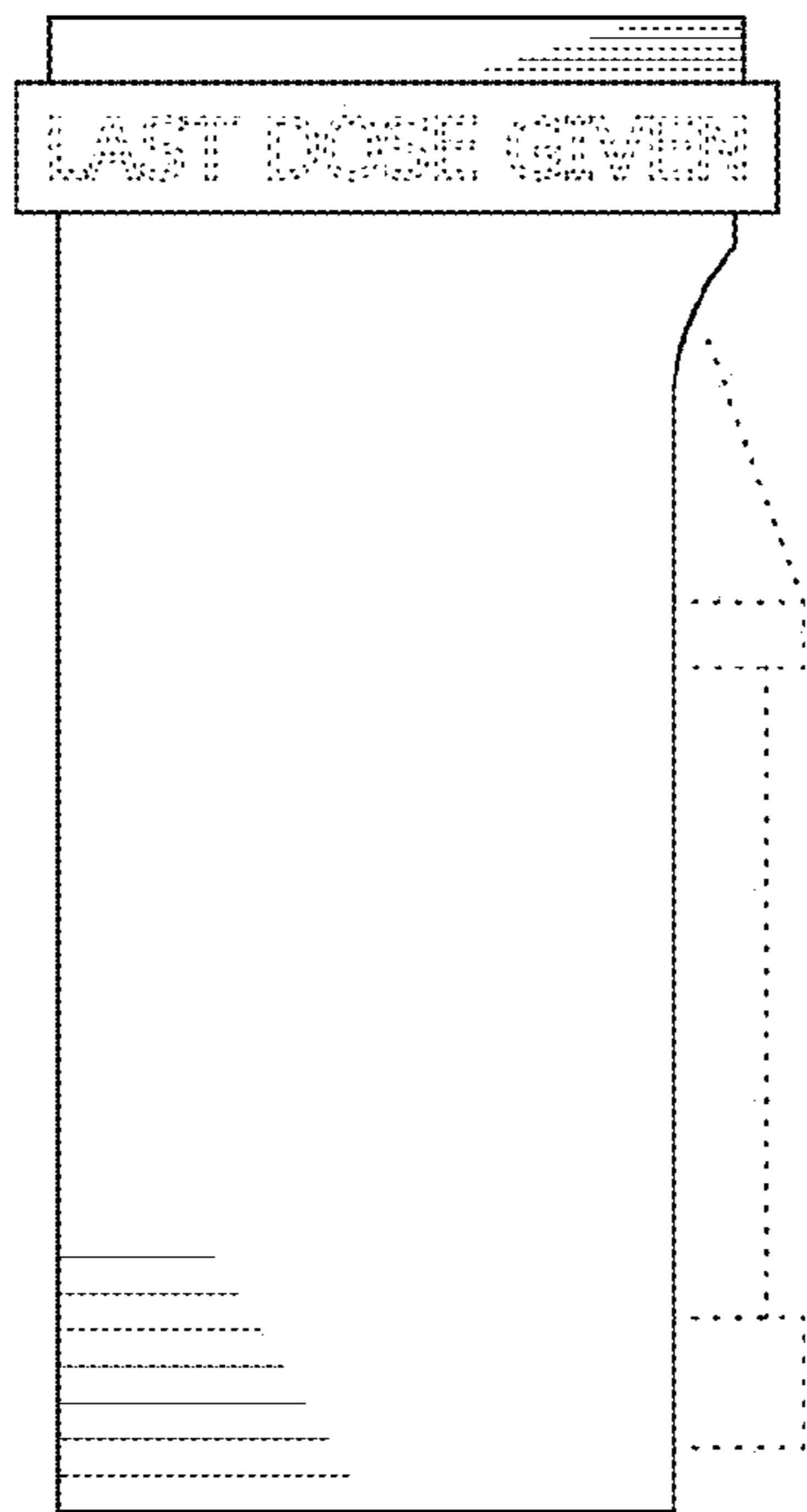

FIG. 8

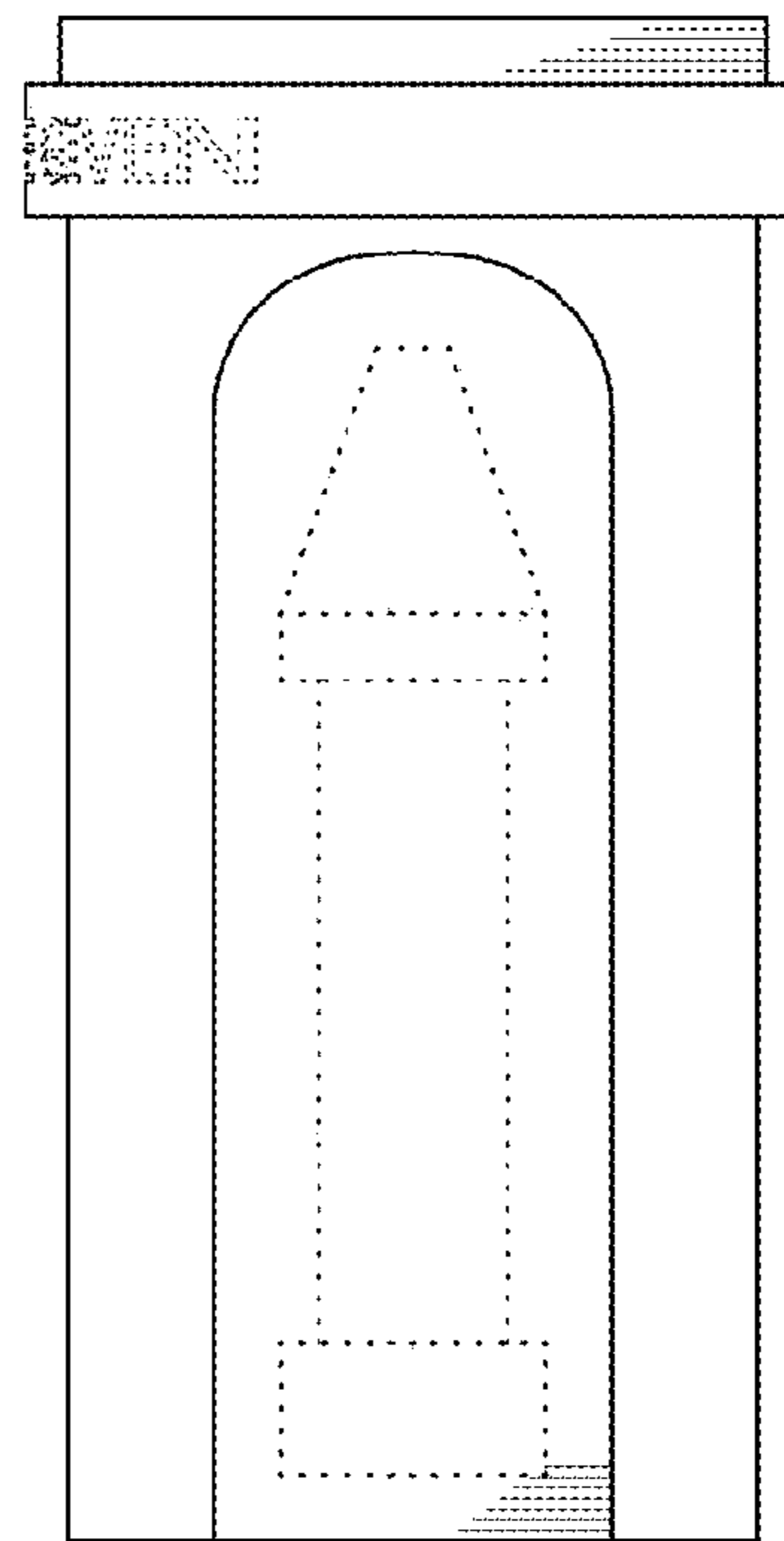

FIG. 9

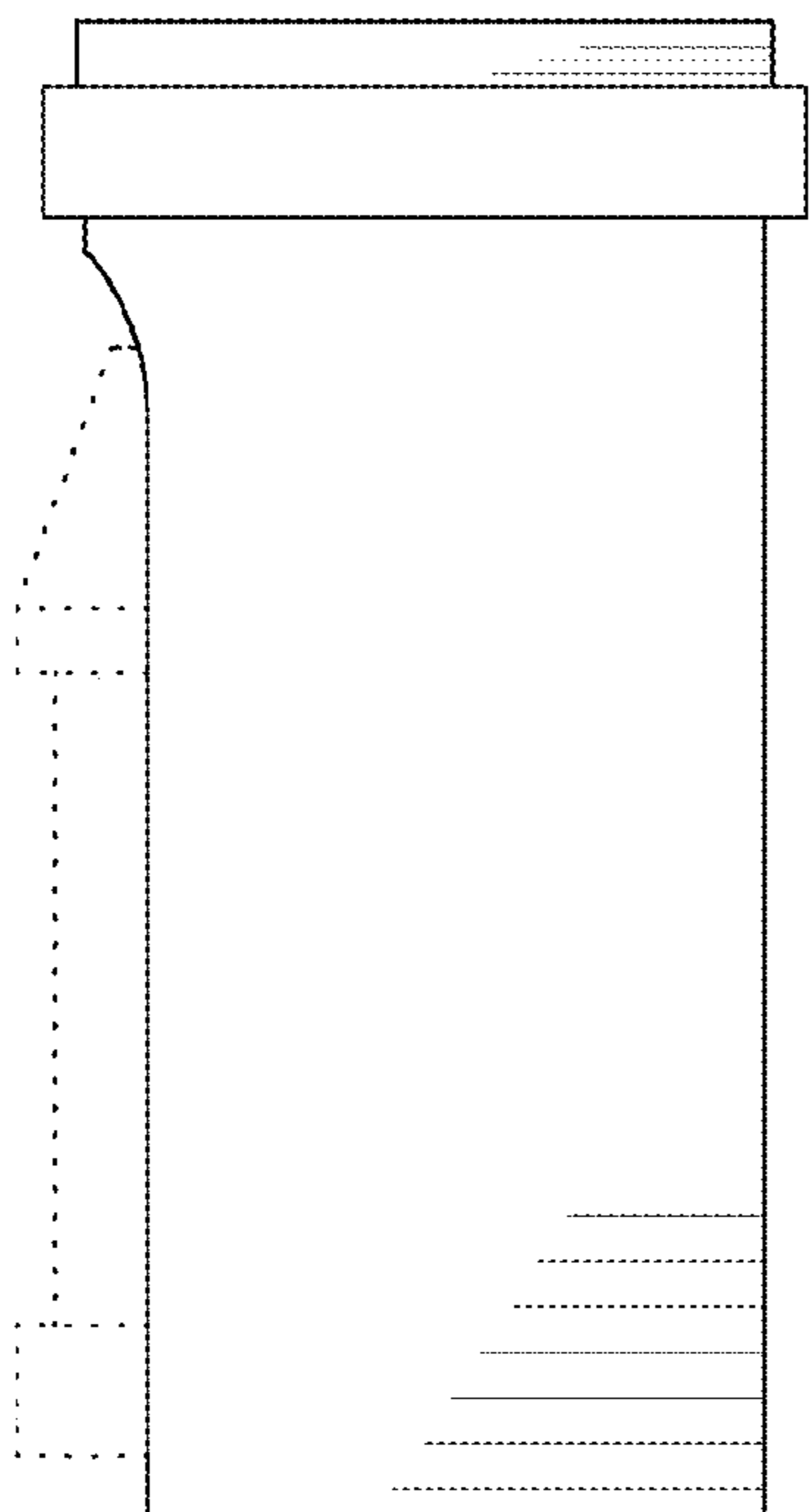

FIG. 10

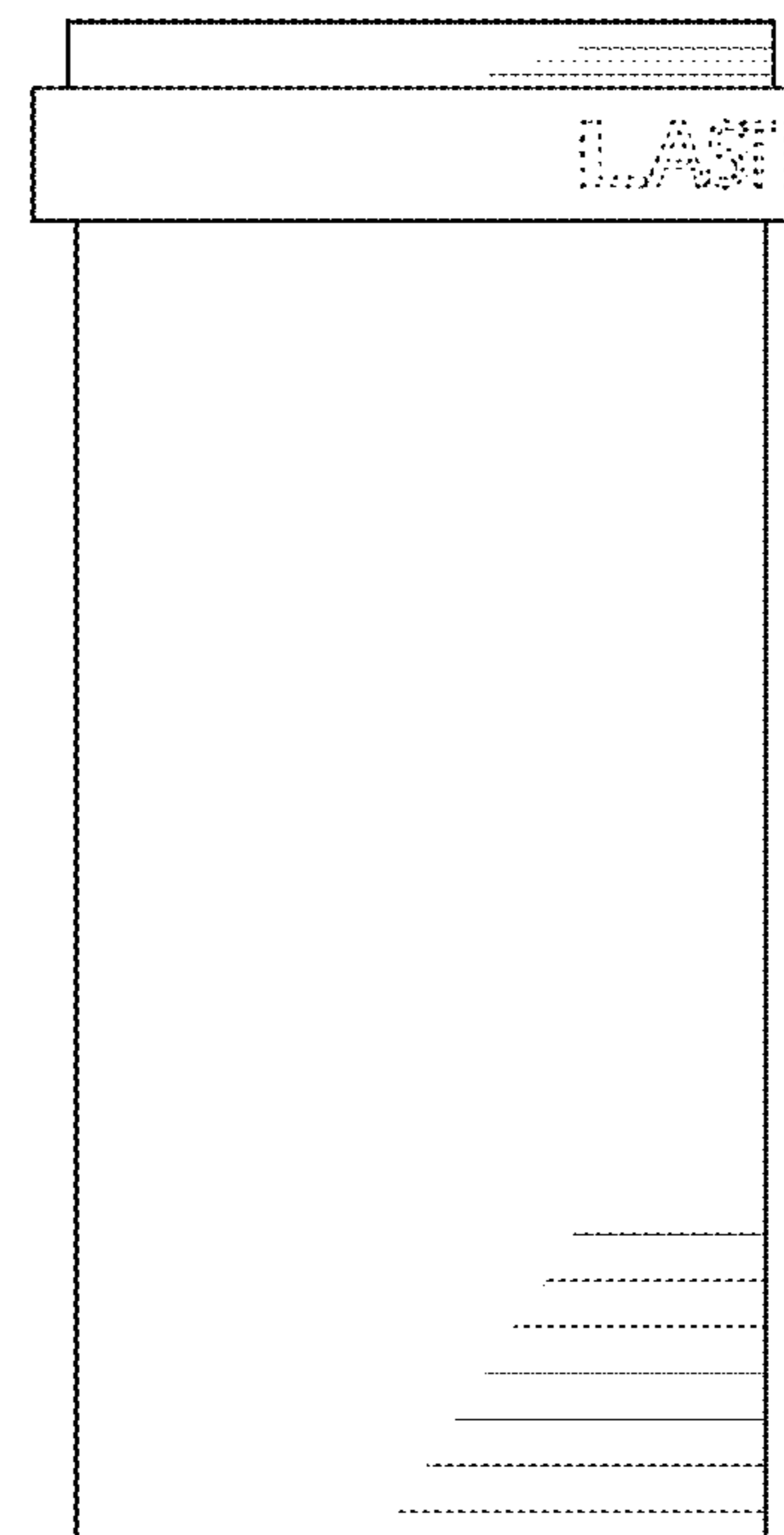

FIG. 11

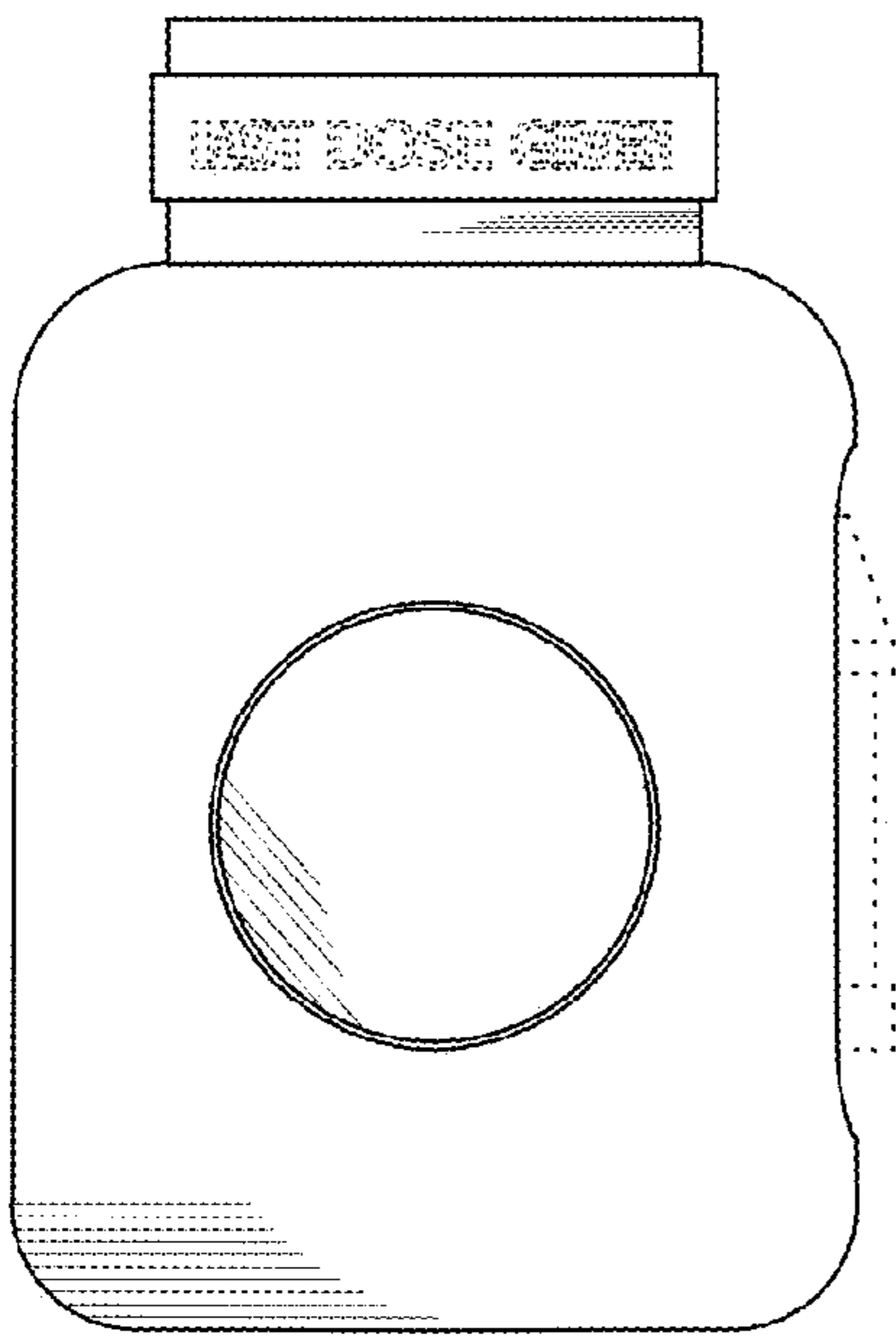

FIG. 12

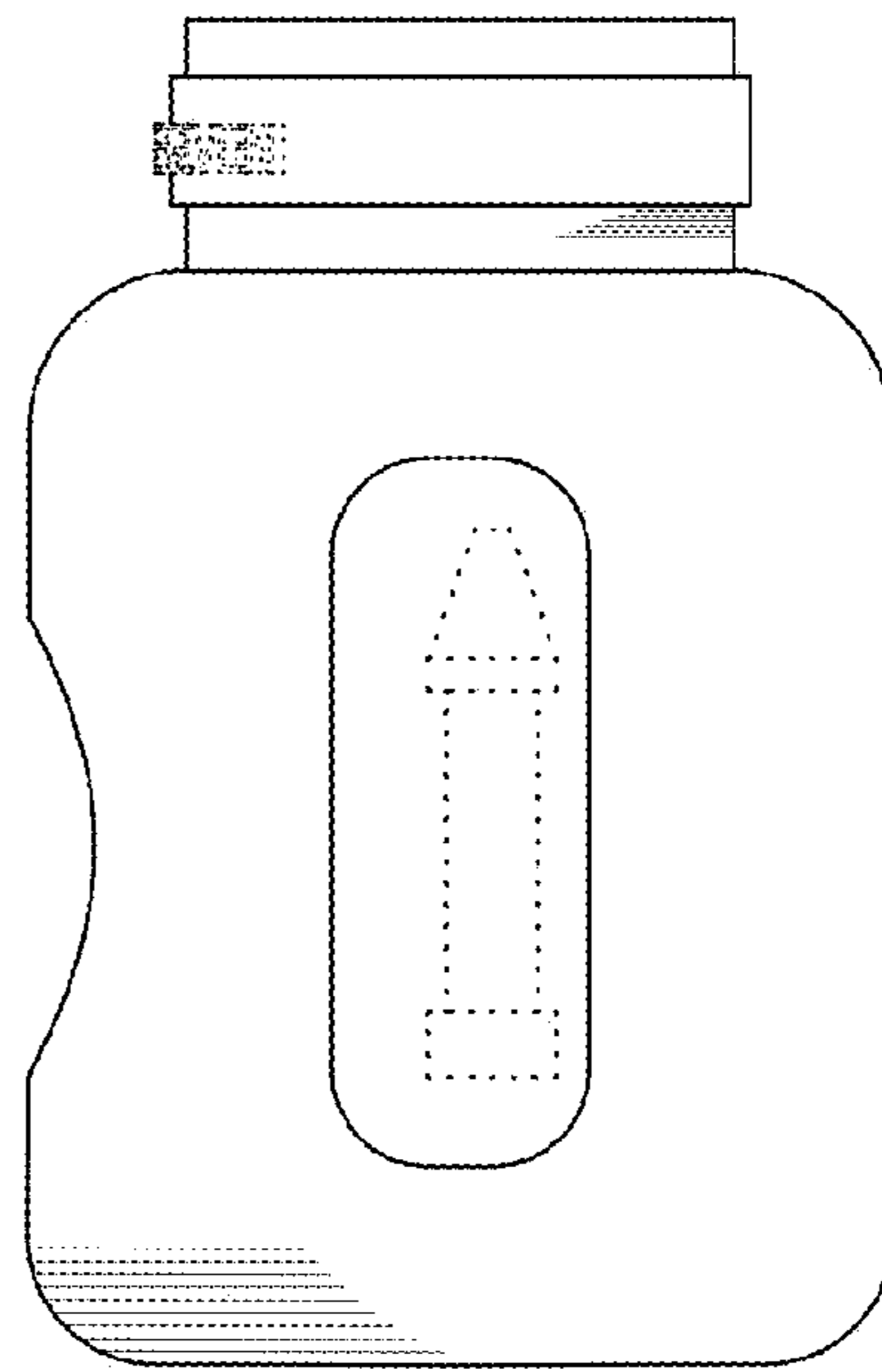

FIG. 13

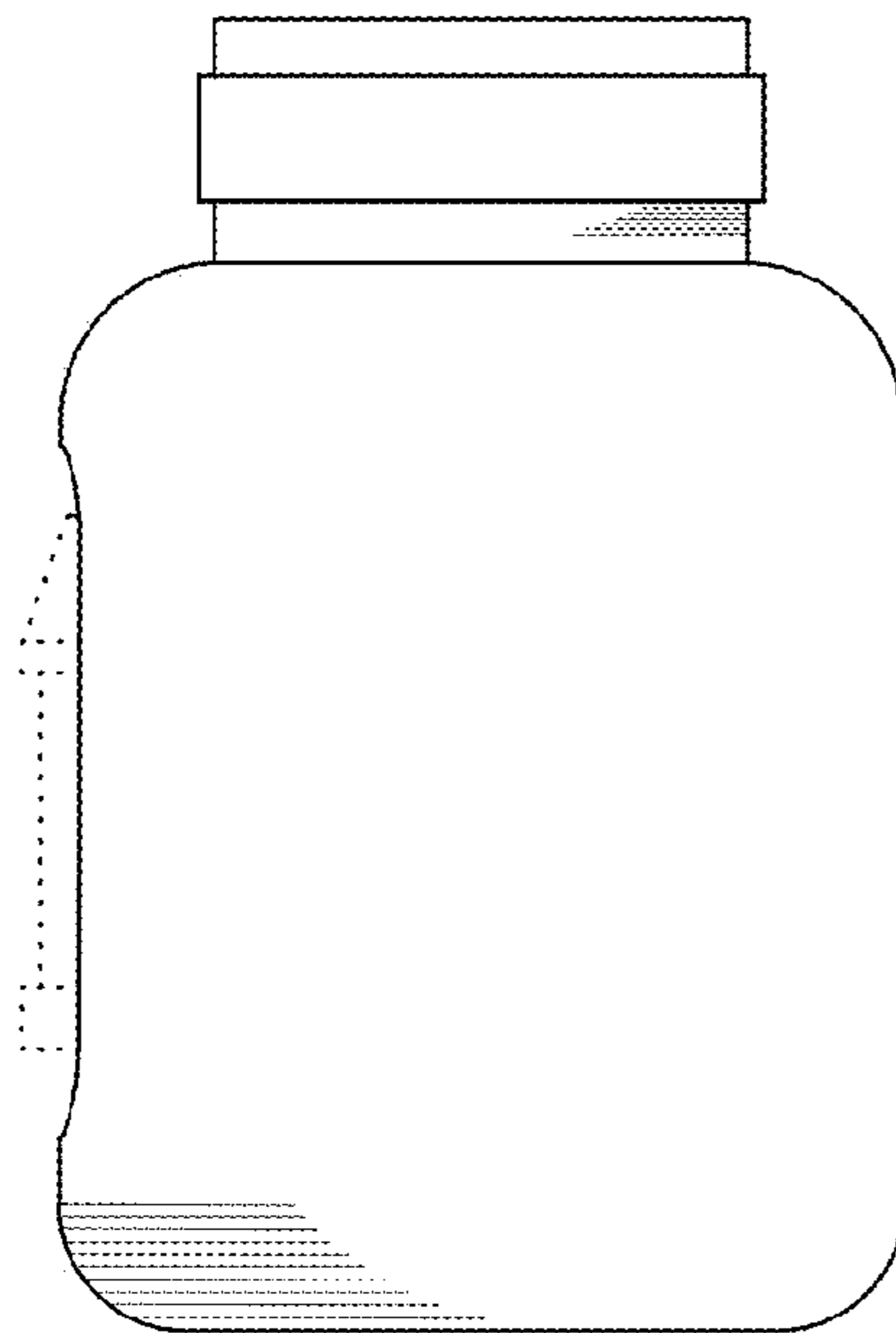

FIG. 14

