



US00D733358S

(12) **United States Design Patent**
Palmer et al.

(10) **Patent No.:** **US D733,358 S**
(45) **Date of Patent:** **** *Jun. 30, 2015**

- (54) **CLIPPER HEAD**
- (71) Applicant: **Medline Industries, Inc.**, Mundelein, IL (US)
- (72) Inventors: **Bradley Palmer**, Chicago, IL (US);
Chenglin Zheng, Henan Province (CN)
- (73) Assignee: **MEDLINE INDUSTRIES, INC.**,
Mundelein, IL (US)

D566,898 S	4/2008	Hara	
D567,444 S *	4/2008	Giannini	D28/54
D567,445 S *	4/2008	Giannini	D28/54
D567,446 S	4/2008	Hara et al.	
D583,098 S *	12/2008	Giannini	D28/54
D602,636 S	10/2009	Lothar et al.	
D624,244 S	9/2010	Giannini	
D628,743 S	12/2010	Shoavi	
D696,460 S *	12/2013	Prat-Pfister et al.	D28/53
D698,079 S *	1/2014	Zheng et al.	D28/53
D698,086 S *	1/2014	Zheng et al.	D28/54
2003/0145469 A1	8/2003	Ogawa et al.	

(*) Notice: This patent is subject to a terminal disclaimer.

(**) Term: **14 Years**

(21) Appl. No.: **29/493,877**

(22) Filed: **Jun. 13, 2014**

Related U.S. Application Data

(63) Continuation of application No. 29/446,422, filed on Feb. 22, 2013, now Pat. No. Des. 711,594.

(51) **LOC (10) Cl.** **28-03**

(52) **U.S. Cl.**
USPC **D28/54**

(58) **Field of Classification Search**
USPC D28/44-48, 49-54; 30/34.05, 32, 34.1, 30/34.2, 43-43.92, 526-527, 44-45, 341, 30/195-222, 272.1, 226-227, 231, 30/233-233.5
CPC B26B 19/12; B26B 19/00; B26B 19/06; B26B 19/063; B26B 19/066
See application file for complete search history.

(56) **References Cited**

U.S. PATENT DOCUMENTS

D342,345 S	12/1993	Yonezawa	
D377,404 S *	1/1997	Izumi	D28/49
D405,924 S *	2/1999	Lebherz	D28/53
D451,639 S	12/2001	Lior	

FOREIGN PATENT DOCUMENTS

EM	000731179-0003	7/2007
EP	1932633 B1	3/2010

* cited by examiner

Primary Examiner — Jennifer Rivard

(74) *Attorney, Agent, or Firm* — McAndrews Held & Malloy, Ltd.

(57) **CLAIM**

The ornamental design for a clipper head, as shown and described.

DESCRIPTION

FIG. 1 is a front perspective view of a clipper head showing our new design;
FIG. 2 is a rear perspective view thereof;
FIG. 3 is a rear elevation view thereof;
FIG. 4 is a front elevation view thereof;
FIG. 5 is a left side elevation view thereof;
FIG. 6 is a right side elevation view thereof;
FIG. 7 is a top plan view thereof; and,
FIG. 8 is a bottom plan view thereof.
The dot dash lines in the figures represent an unclaimed boundary line and form no part of the claimed design. The even spaced broken lines are for purposes of illustrating environment and form no part of the claimed design.

1 Claim, 1 Drawing Sheet

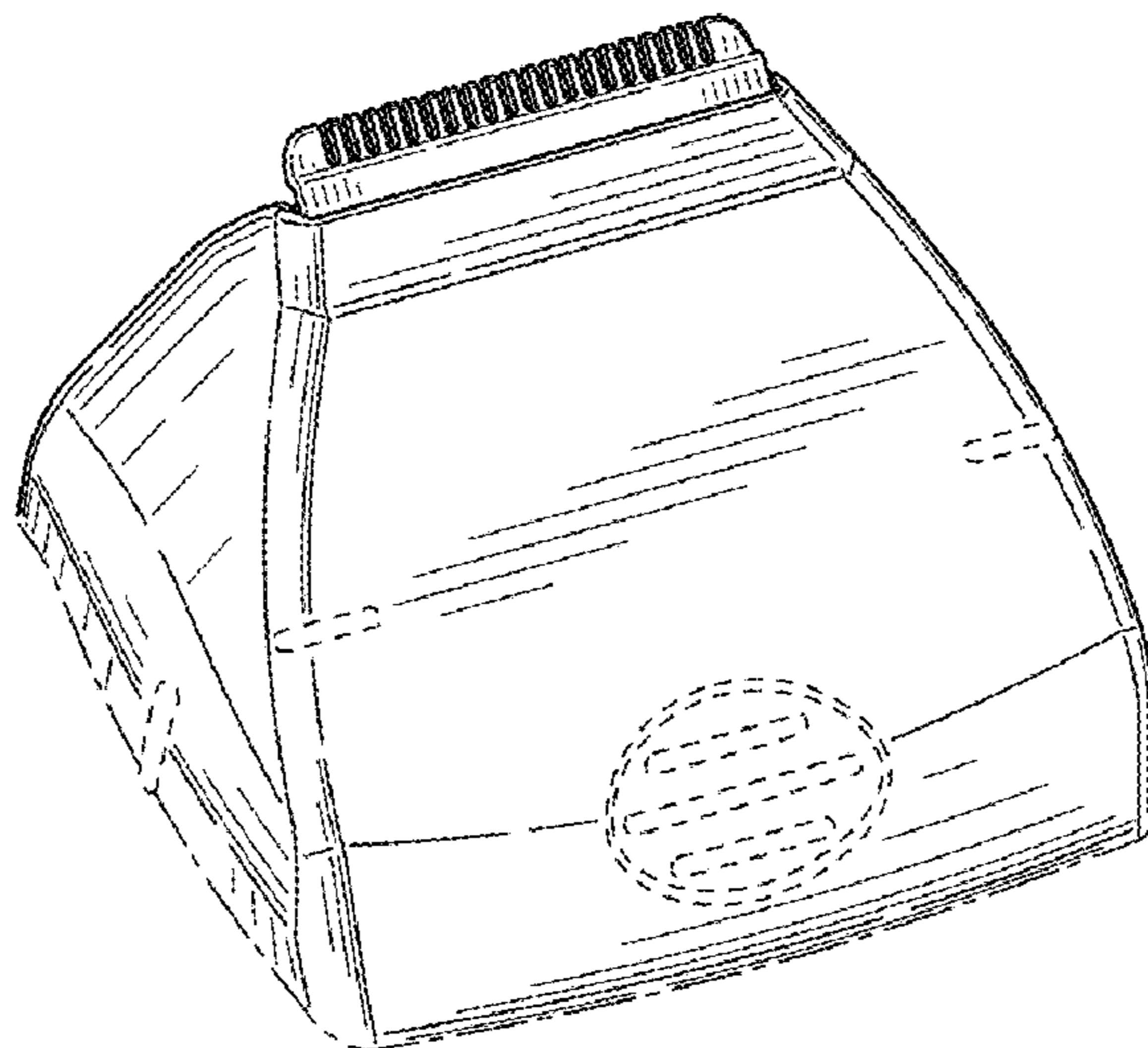

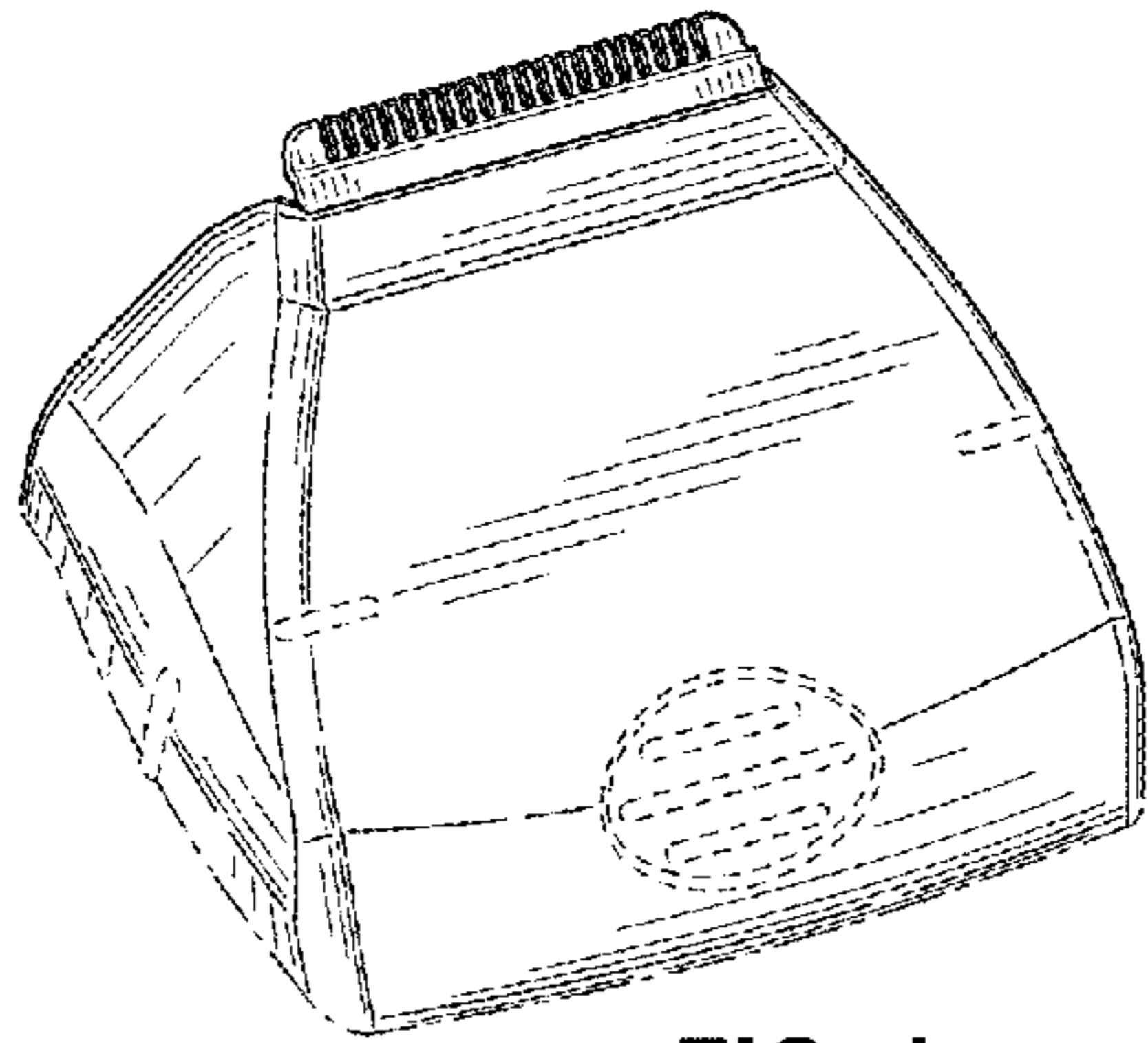

FIG. 1

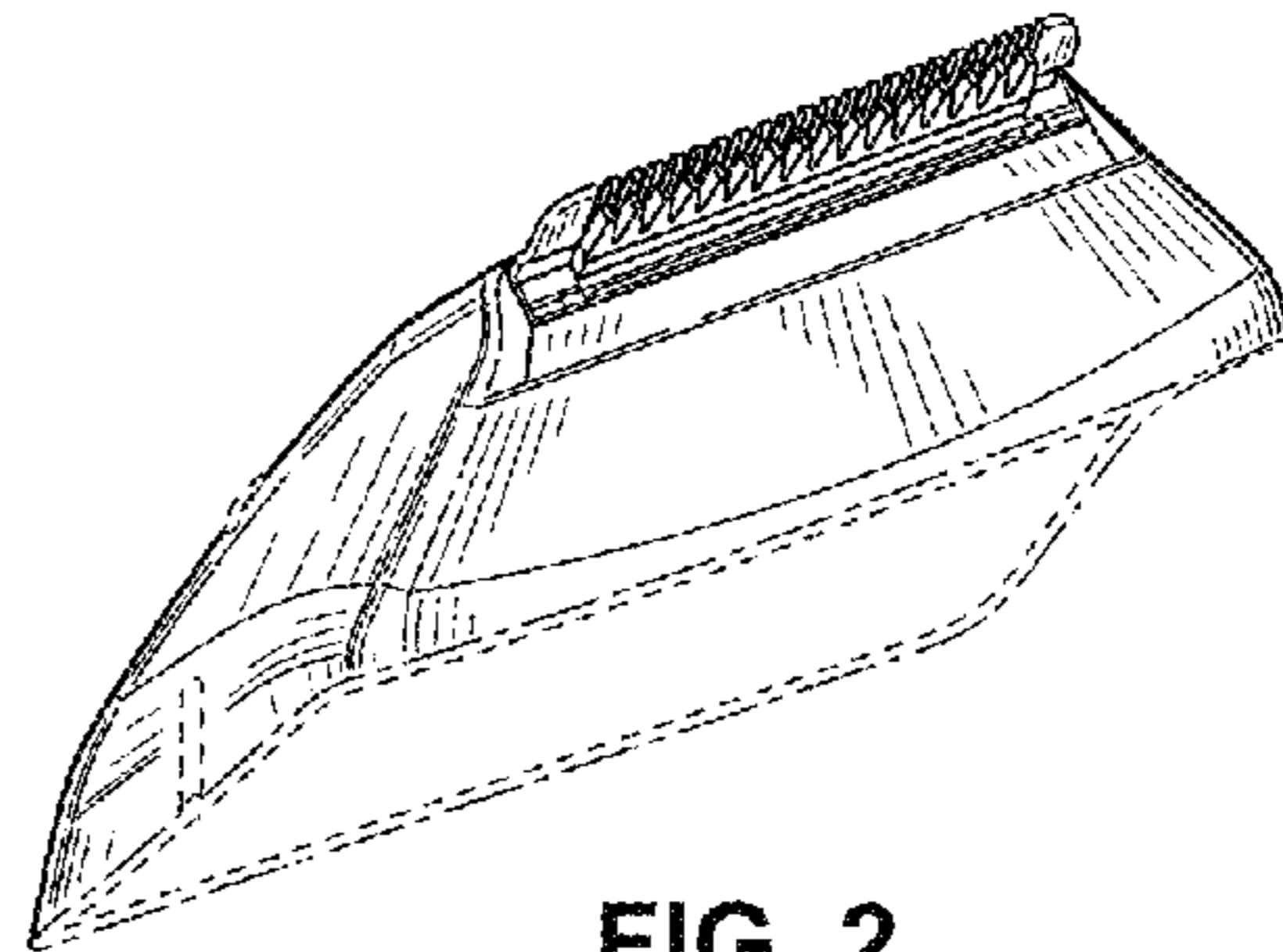

FIG. 2

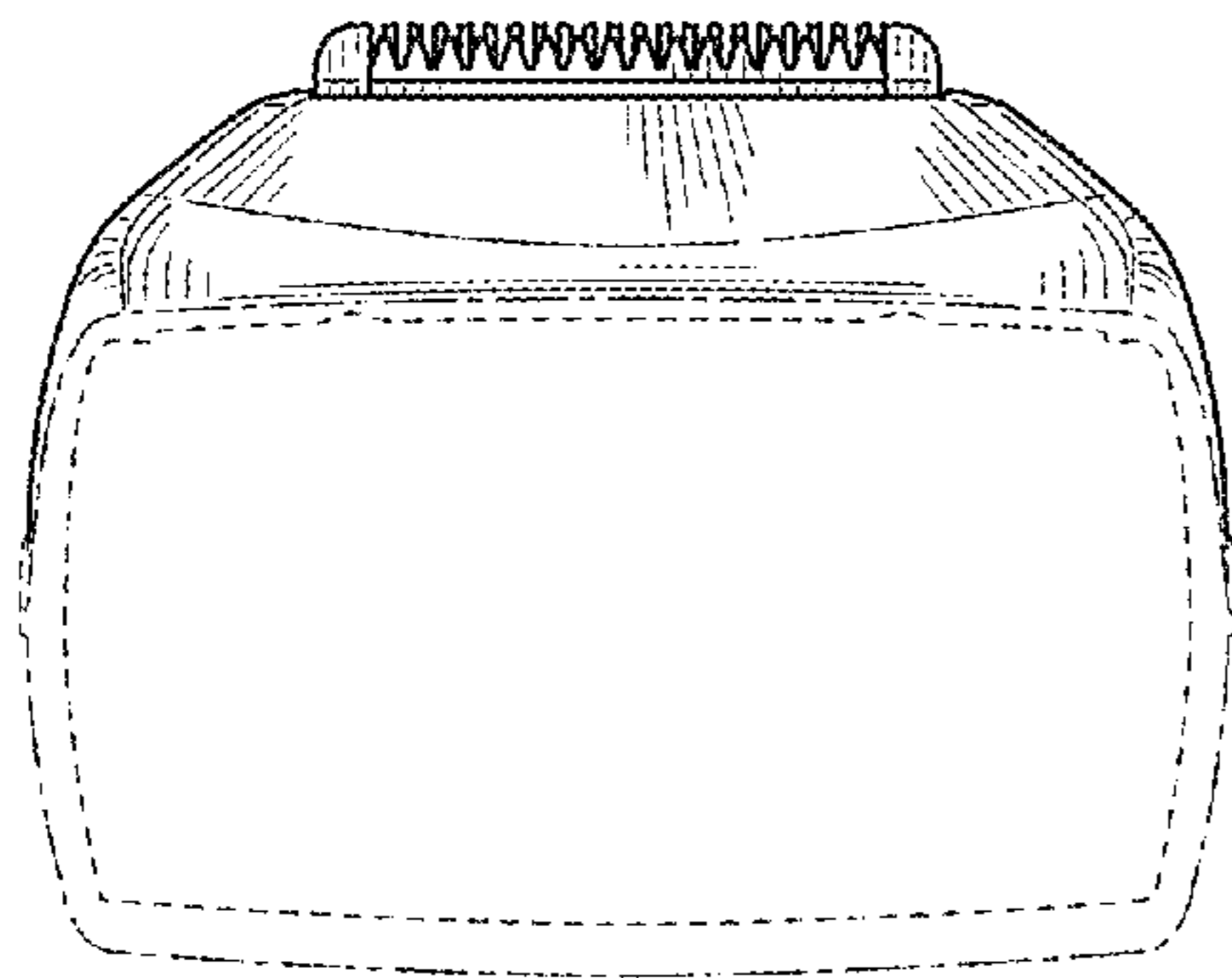

FIG. 3

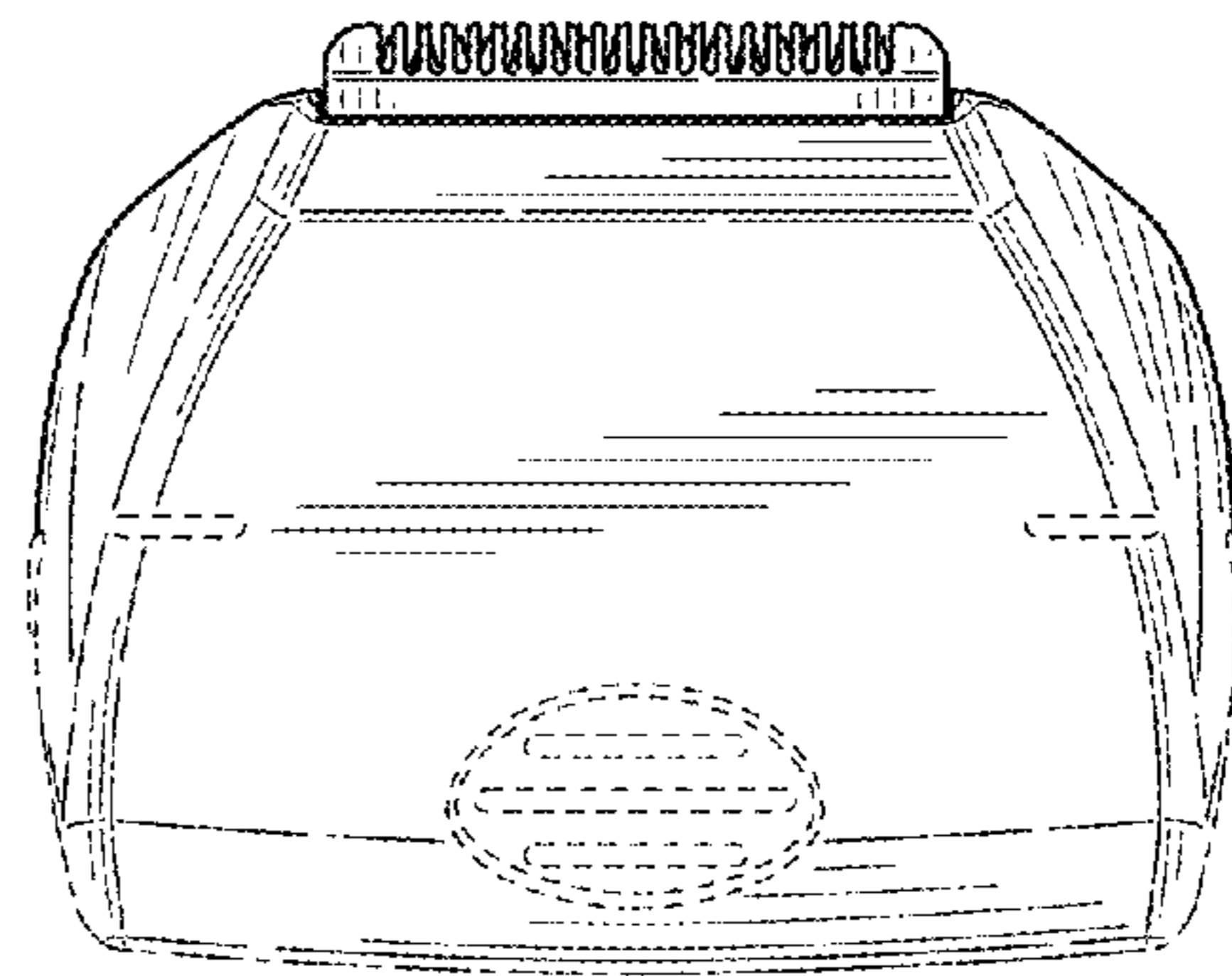

FIG. 4

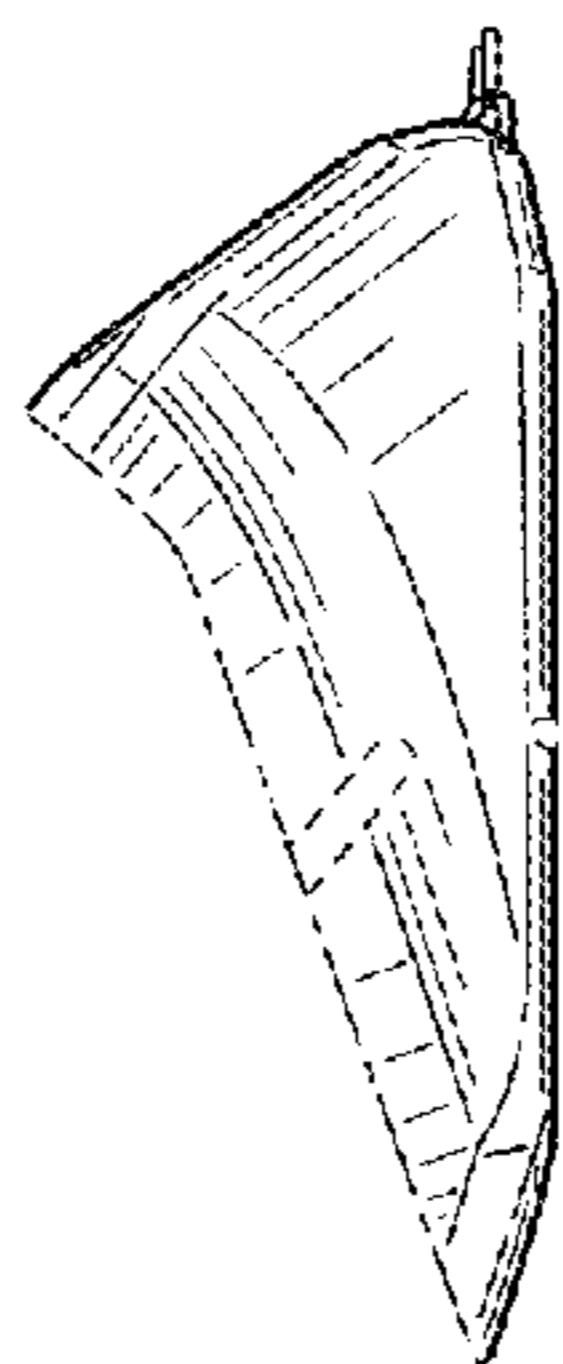

FIG. 5

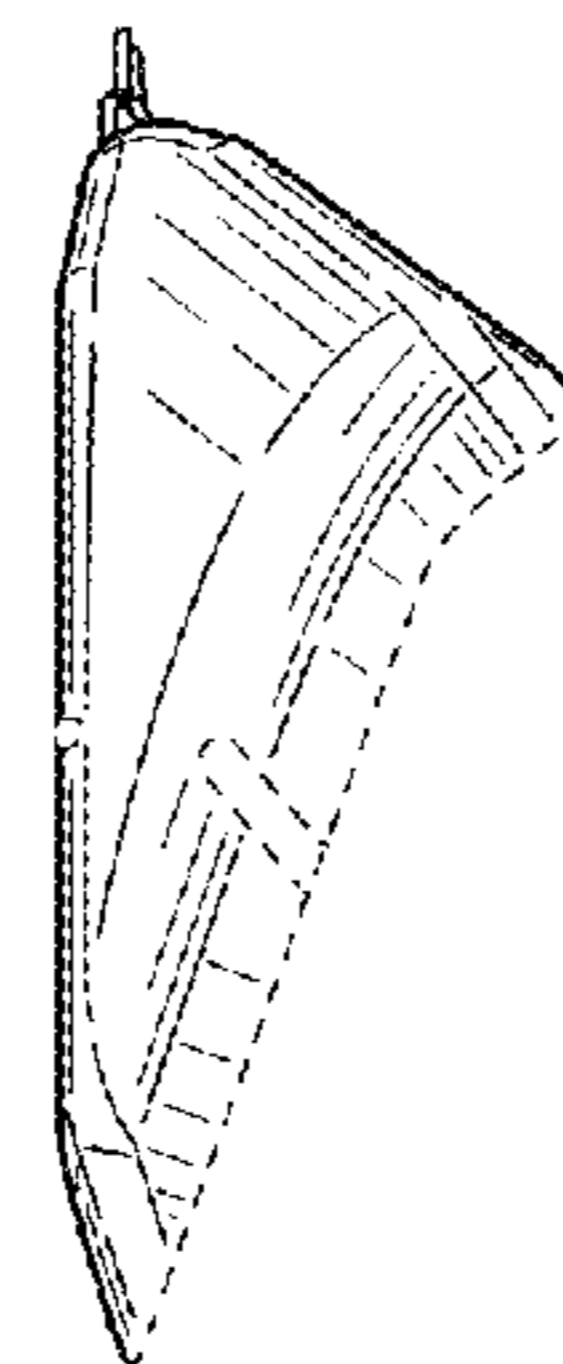

FIG. 6

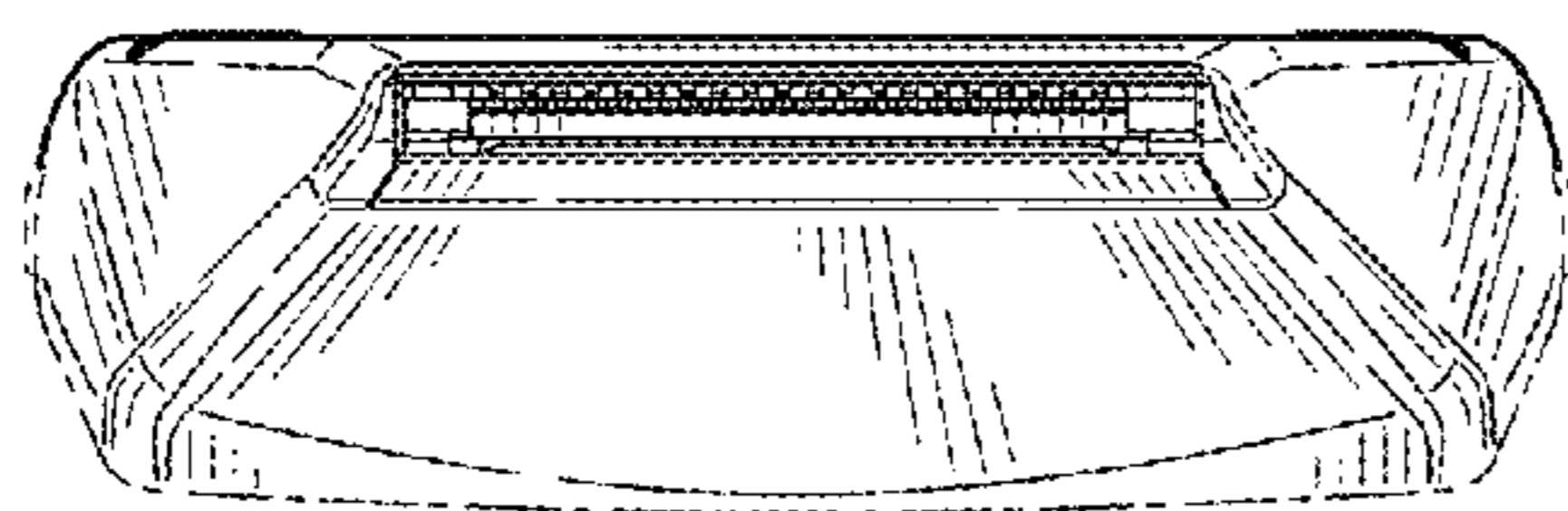

FIG. 7

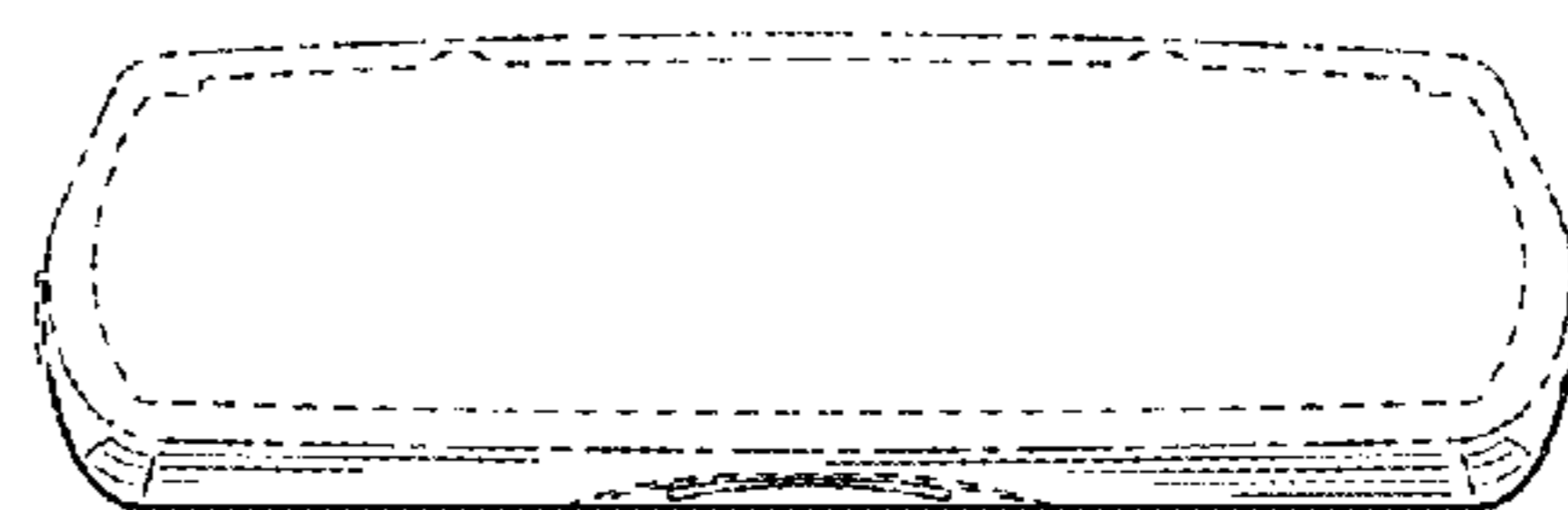

FIG. 8