



US00D733297S

(12) **United States Design Patent**  
**Harrison et al.**

(10) **Patent No.:** **US D733,297 S**  
(45) **Date of Patent:** **\*\* Jun. 30, 2015**

(54) **HANDLE FOR SUTURING INSTRUMENT**

(71) Applicant: **Anchor Orthopedics XT Inc.**,  
Mississauga (CA)

(72) Inventors: **Robert Harrison**, Milton (CA); **Steve Copeland**, Barrie (CA); **Jonathan Liberty**, Newmarket (CA); **Jeffery Arnett**, Gilbert, AZ (US); **Dylan Hushka**, Niwot, CO (US); **Neil Godara**, Milton (CA)

(73) Assignee: **ANCHER ORTHOPEDICS XT INC.**,  
Mississauga, Ontario (CA)

(\*\*) Term: **14 Years**

(21) Appl. No.: **29/489,200**

(22) Filed: **Apr. 28, 2014**

**Related U.S. Application Data**

(63) Continuation of application No. 29/447,624, filed on Mar. 5, 2013, now Pat. No. Des. 706,928.

(51) **LOC (10) Cl.** ..... **24-02**

(52) **U.S. Cl.**  
USPC ..... **D24/145**

(58) **Field of Classification Search**  
USPC ..... D24/133, 145-147; D8/49-51, 68;  
227/175.1, 180.1, 901-902; 606/139,  
606/142-143, 170  
See application file for complete search history.

(56) **References Cited**

**U.S. PATENT DOCUMENTS**

D282,400 S \* 1/1986 Guy et al. .... D24/145  
D284,219 S \* 6/1986 Green et al. .... D24/145

(Continued)

*Primary Examiner* — Wan Laymon

(74) *Attorney, Agent, or Firm* — Nir Lipshitz; Glenn Arnold

(57) **CLAIM**

The ornamental design for a handle for a suturing instrument, as shown and described.

**DESCRIPTION**

FIG. 1 is a top, front, left perspective view of a handle for a suturing instrument, with the trigger in a first position, showing our new design;  
FIG. 2 is a bottom, front, right perspective view of the handle for a suturing instrument of FIG. 1;  
FIG. 3 is a left side view of the handle for a suturing instrument of FIG. 1;  
FIG. 4 is a right side view of the handle for a suturing instrument of FIG. 1;  
FIG. 5 is a top side view of the handle for a suturing instrument of FIG. 1;  
FIG. 6 is a bottom side view of the handle for a suturing instrument of FIG. 1;  
FIG. 7 is a front side view of the handle for a suturing instrument of FIG. 1;  
FIG. 8 is a rear side view of the handle for a suturing instrument of FIG. 1;  
FIG. 9 is a top, front, left perspective view of the handle for a suturing instrument of FIG. 1, showing a shaft of the suturing instrument in dashed outline;  
FIG. 10 is a top, front, left perspective exploded view of the handle for a suturing instrument;  
FIG. 11 is a top, front, left perspective view of the handle for a suturing instrument of FIG. 1, with the trigger in an alternate position;  
FIG. 12 is a left side view of the handle for a suturing instrument of FIG. 11;  
FIG. 13 is a top, front, left perspective view of the handle for a suturing instrument of FIG. 1, with the trigger in a second alternate position; and,  
FIG. 14 is a left side view of the handle for a suturing instrument of FIG. 13.  
The broken lines immediately adjacent the shaded areas represent the bounds of the claimed design while all other broken lines are directed to the environment and are for illustrative purposes only; the broken lines form no part of the claimed design.

**1 Claim, 12 Drawing Sheets**

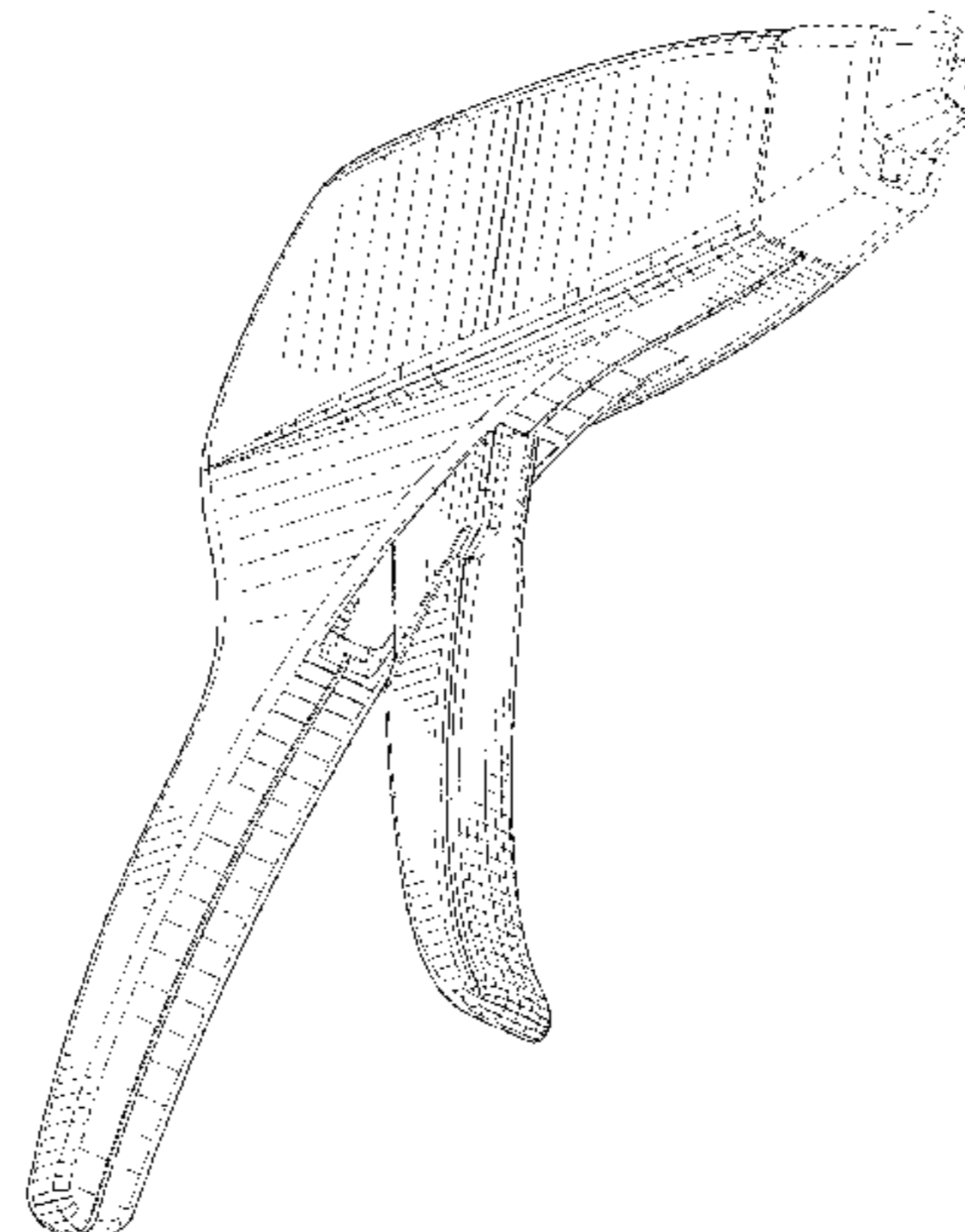
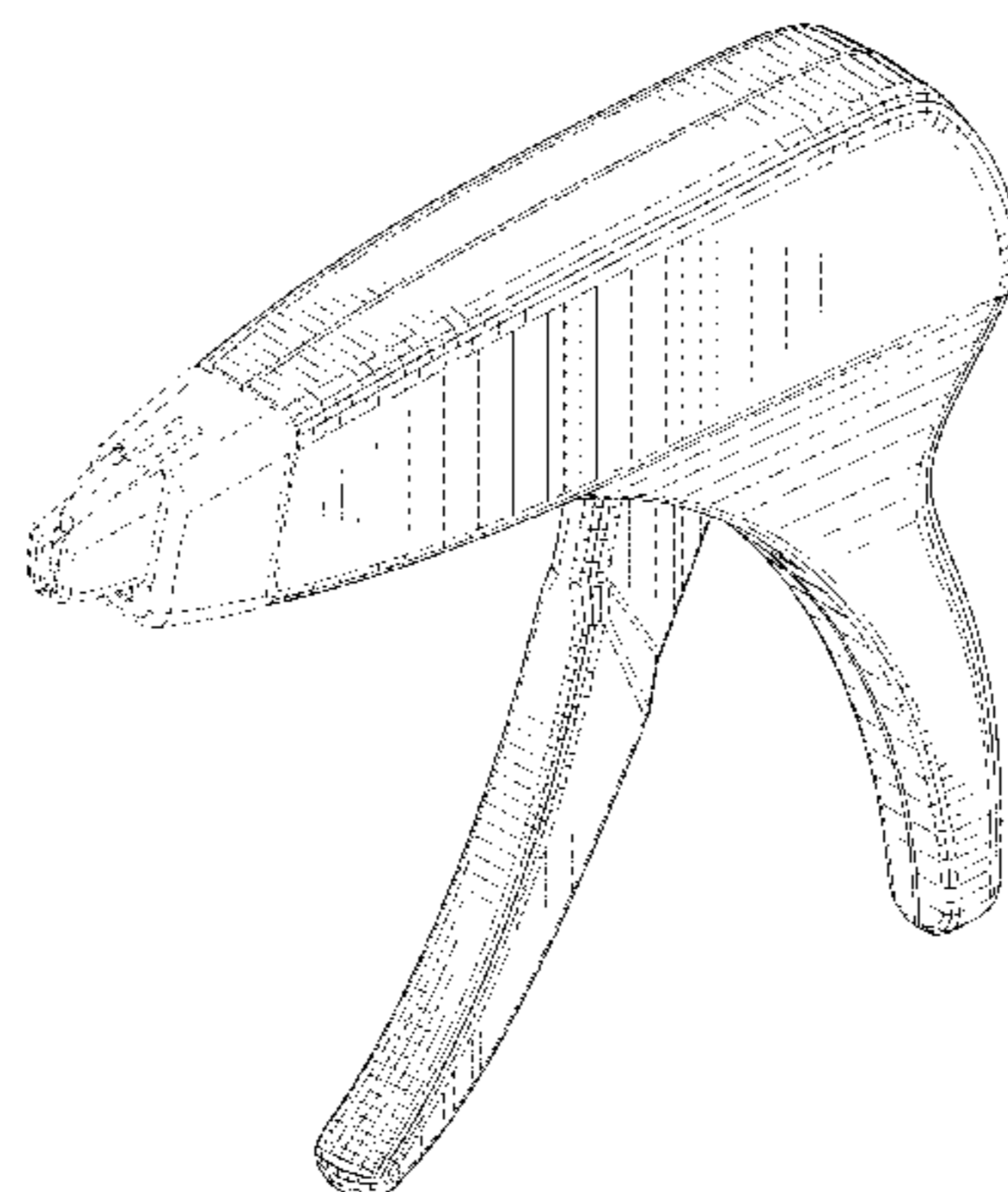

(56)

**References Cited**

U.S. PATENT DOCUMENTS

|               |         |                   |       |         |                   |         |               |       |         |
|---------------|---------|-------------------|-------|---------|-------------------|---------|---------------|-------|---------|
| D327,323 S *  | 6/1992  | Hunt              | ..... | D24/145 | 6,036,667 A *     | 3/2000  | Manna et al.  | ..... | 606/170 |
| 5,601,573 A * | 2/1997  | Fogelberg et al.  | ..... | 606/143 | D502,994 S *      | 3/2005  | Blake, III    | ..... | D24/145 |
| RE35,525 E *  | 6/1997  | Stefanchik et al. | ..... | 606/142 | 8,652,152 B2 *    | 2/2014  | Aranyi et al. | ..... | 606/143 |
| 5,830,221 A * | 11/1998 | Stein et al.      | ..... | 606/142 | 8,728,098 B2 *    | 5/2014  | Daniel et al. | ..... | 606/143 |
|               |         |                   |       |         | 2013/0310849 A1 * | 11/2013 | Malkowski     | ..... | 606/142 |

\* cited by examiner

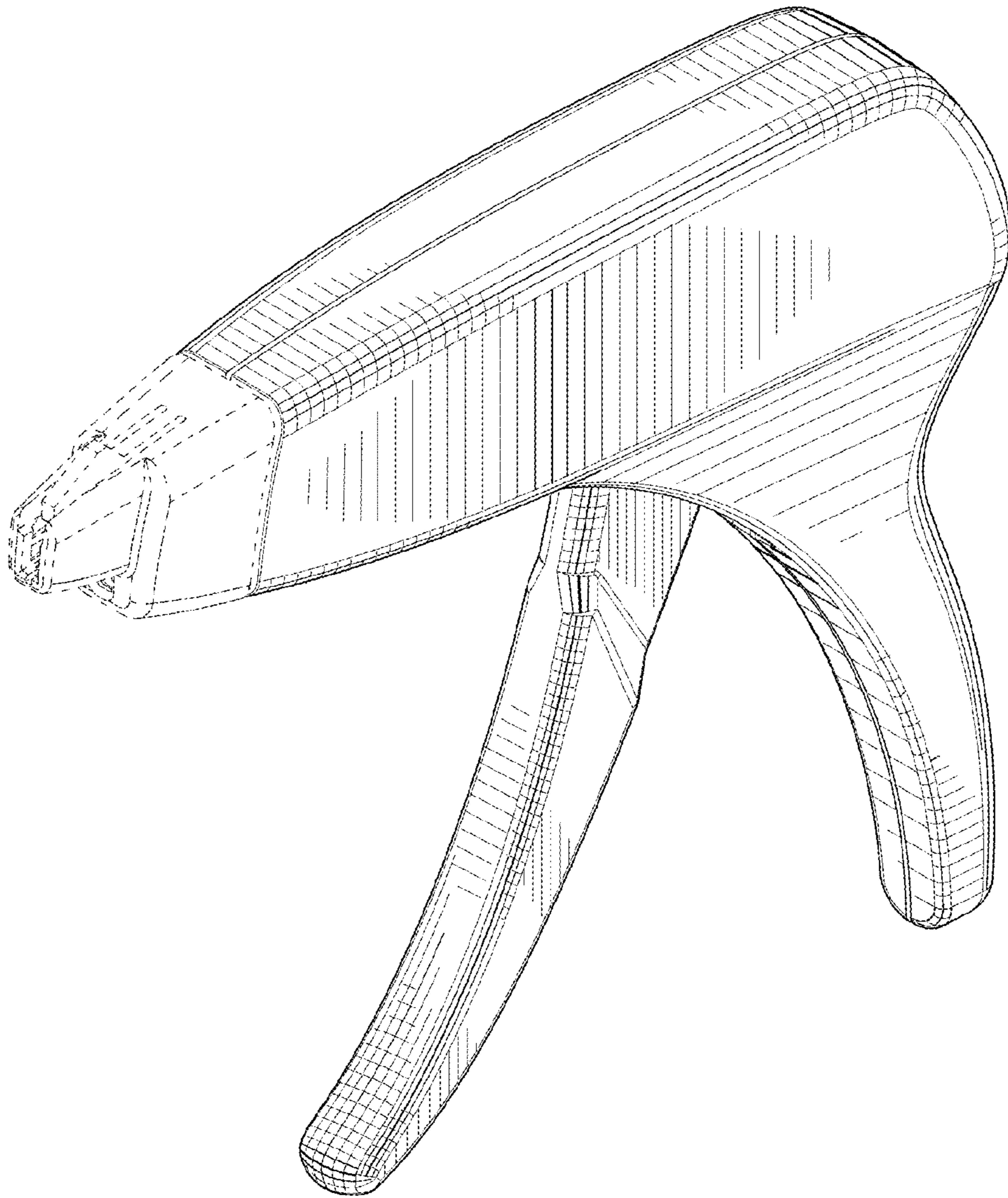

FIG.1

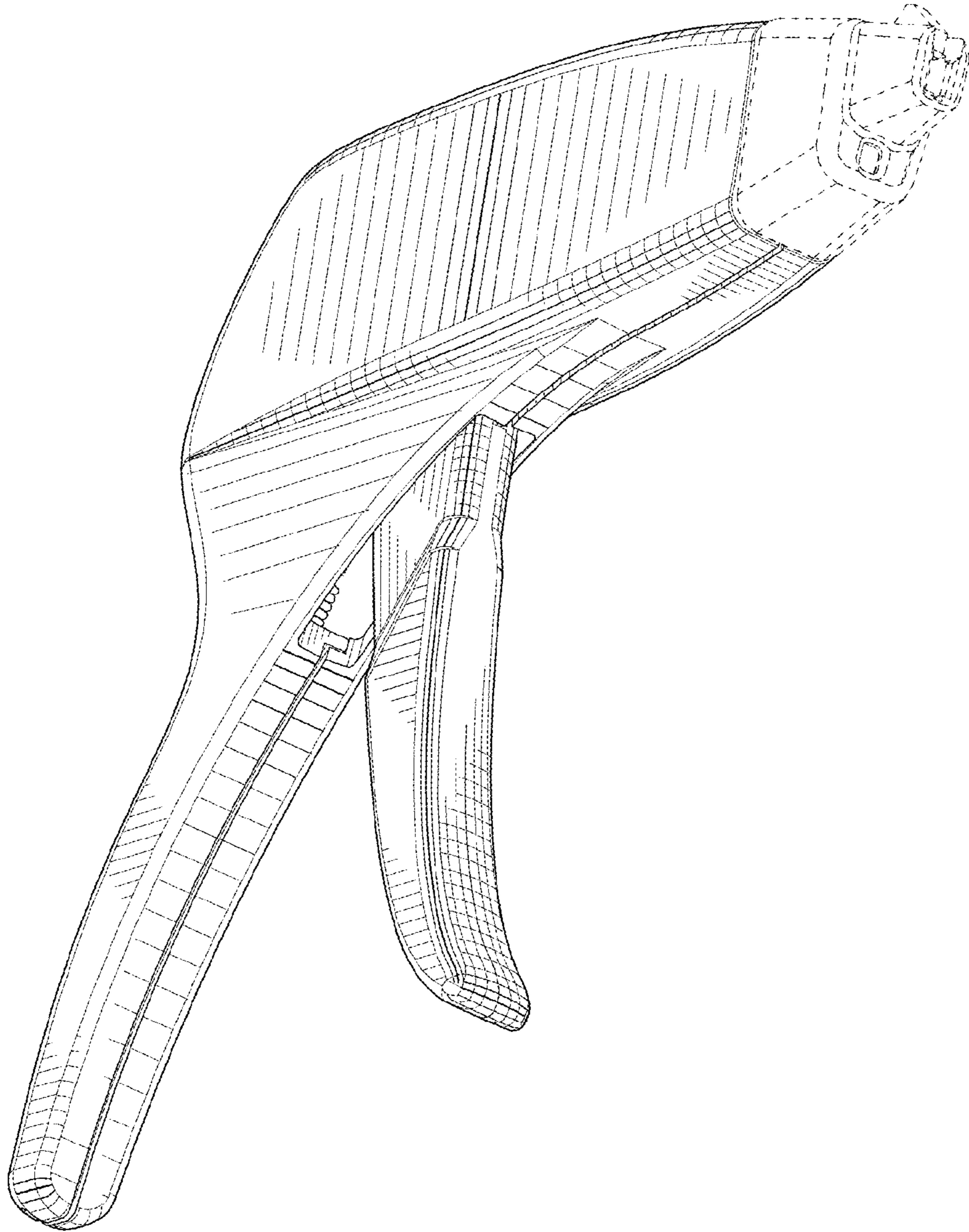

FIG.2

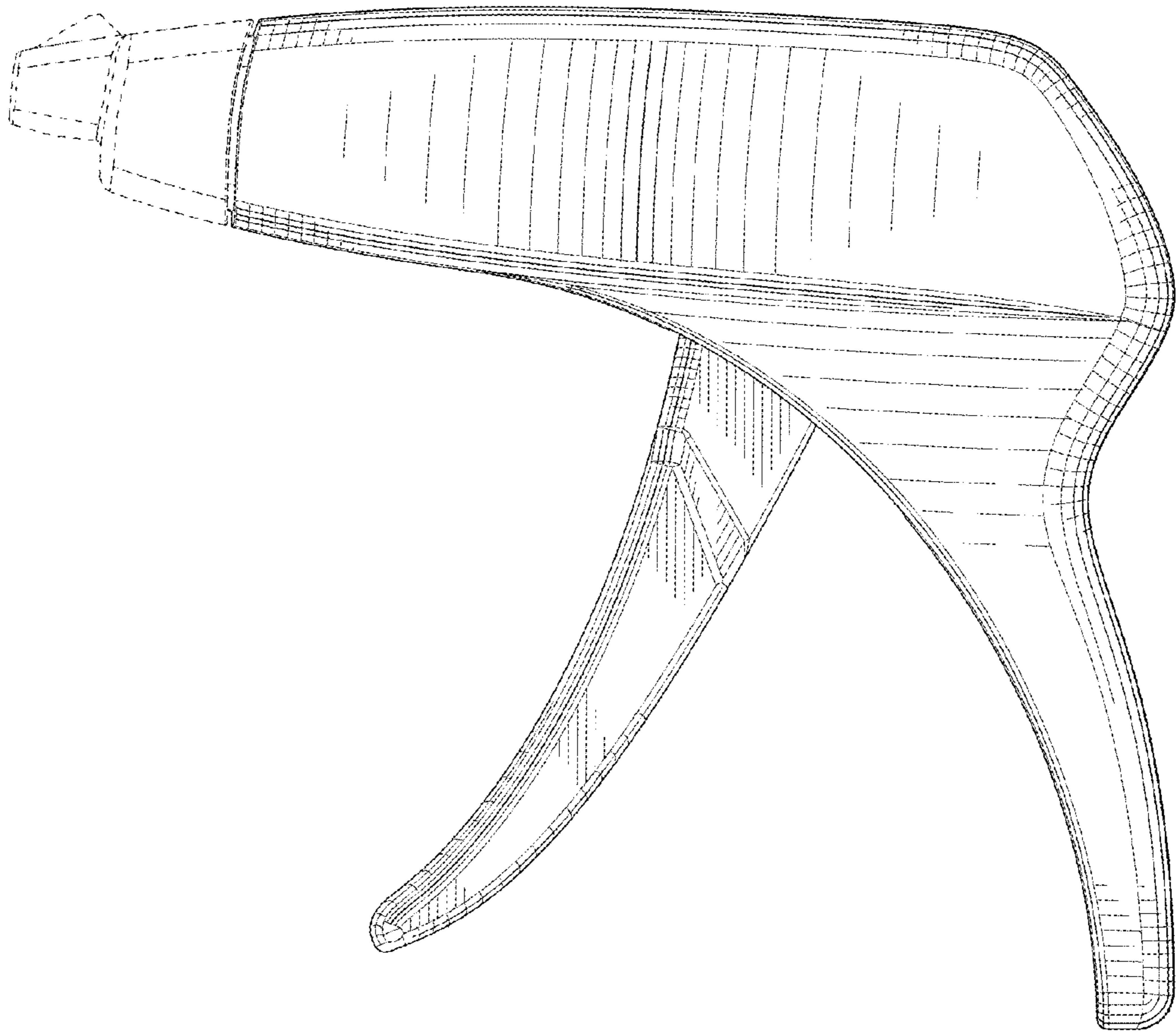

FIG.3

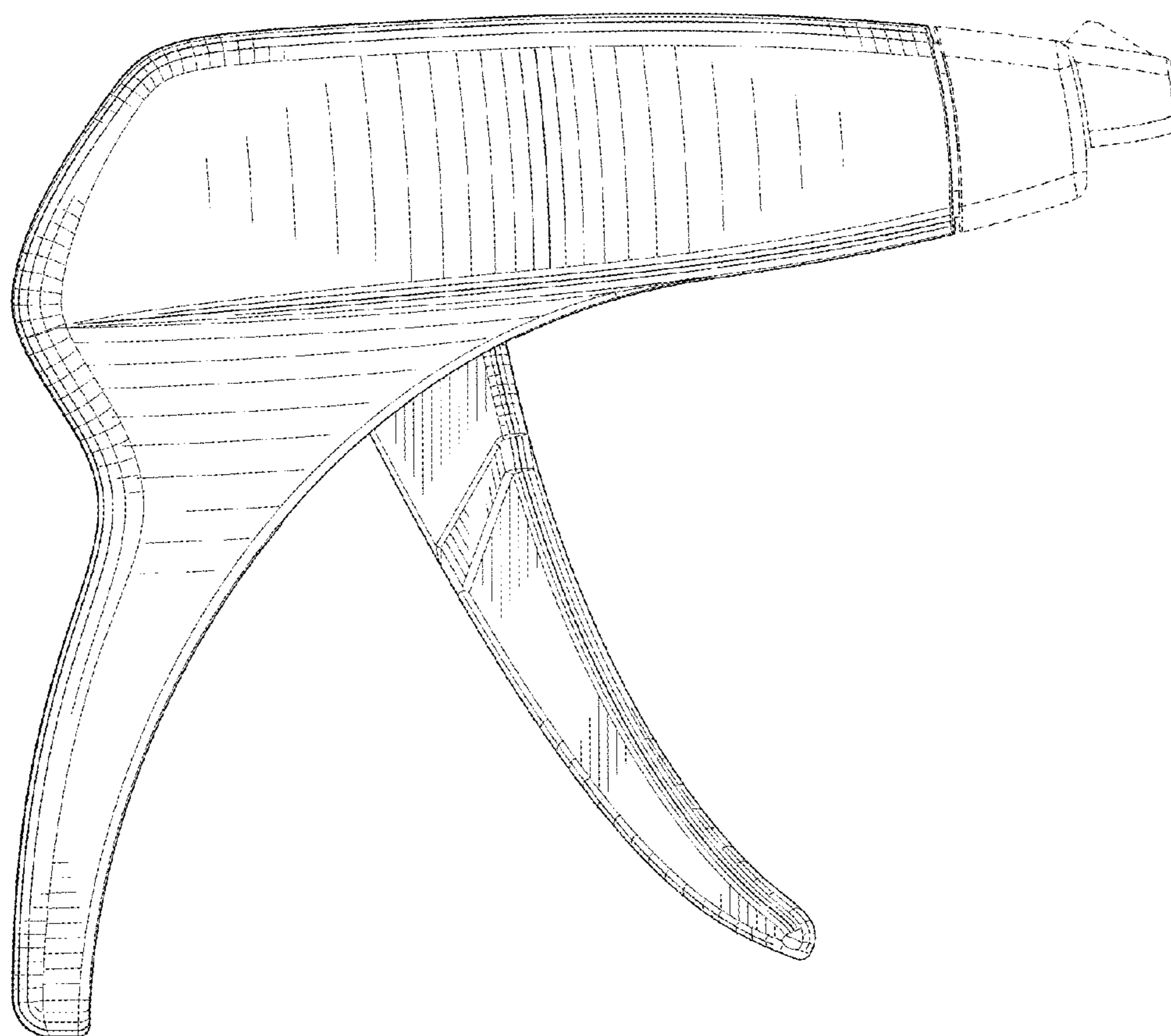

FIG.4

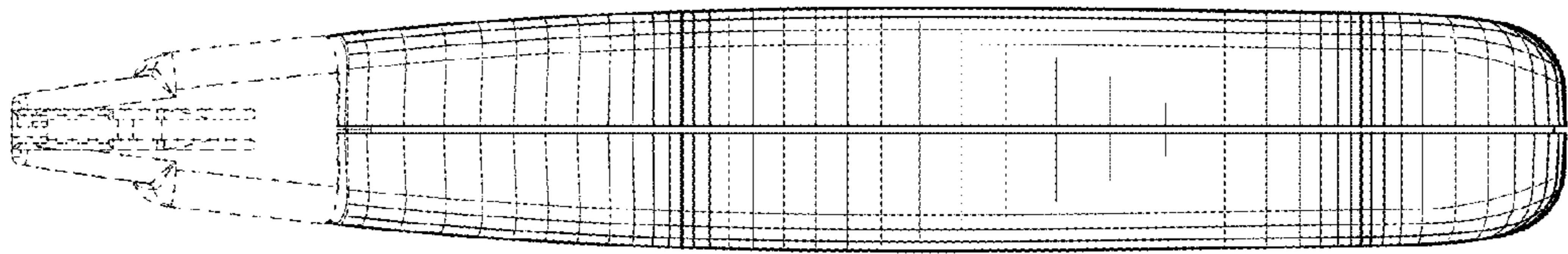

FIG.5

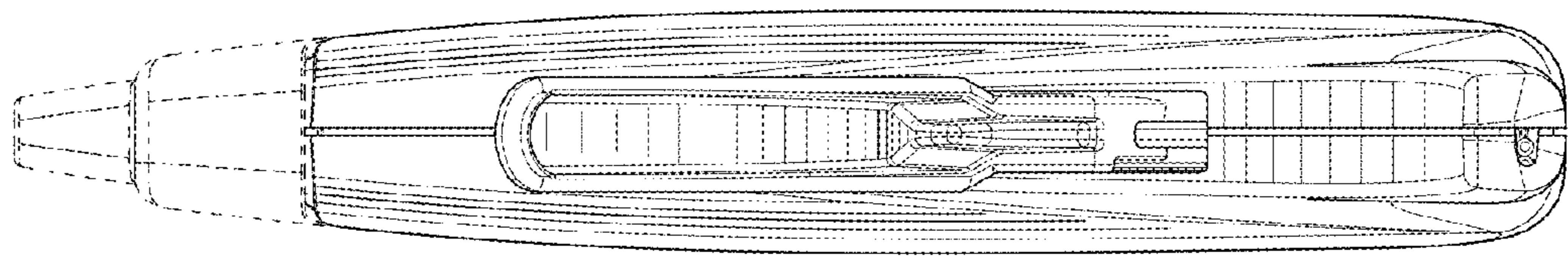

FIG.6

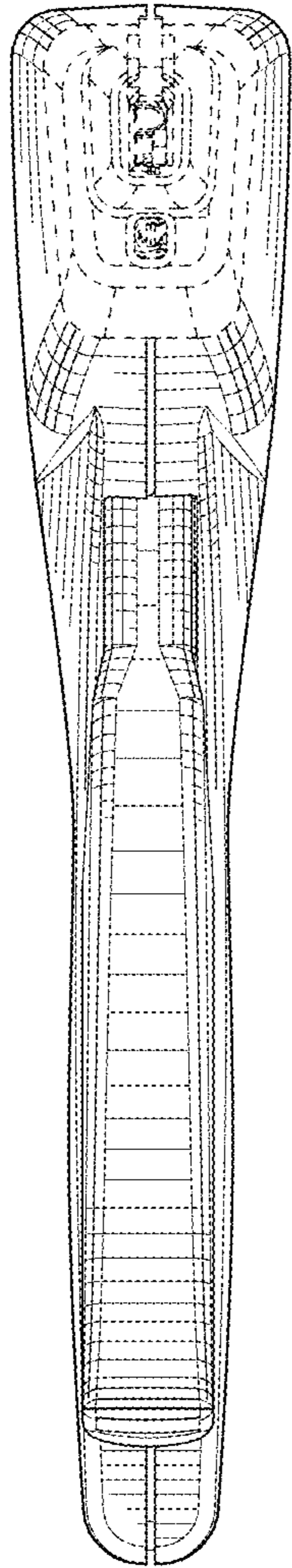

FIG. 7

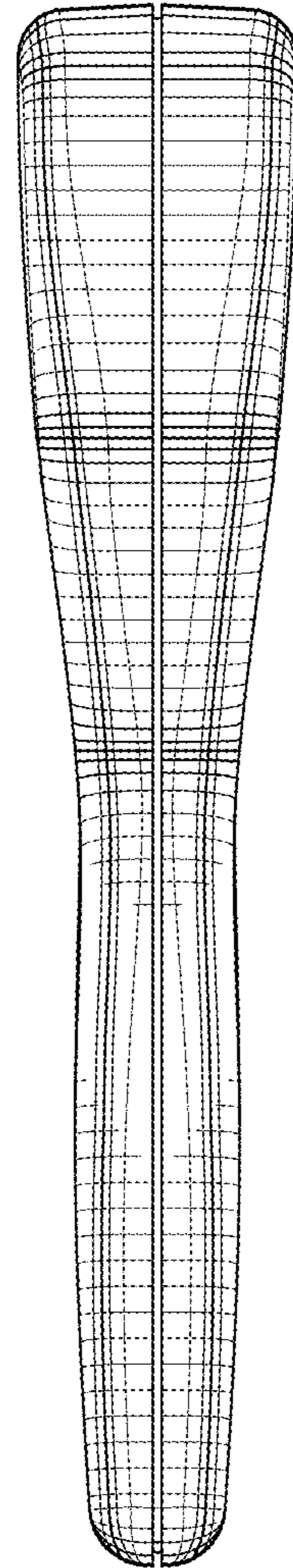

FIG. 8



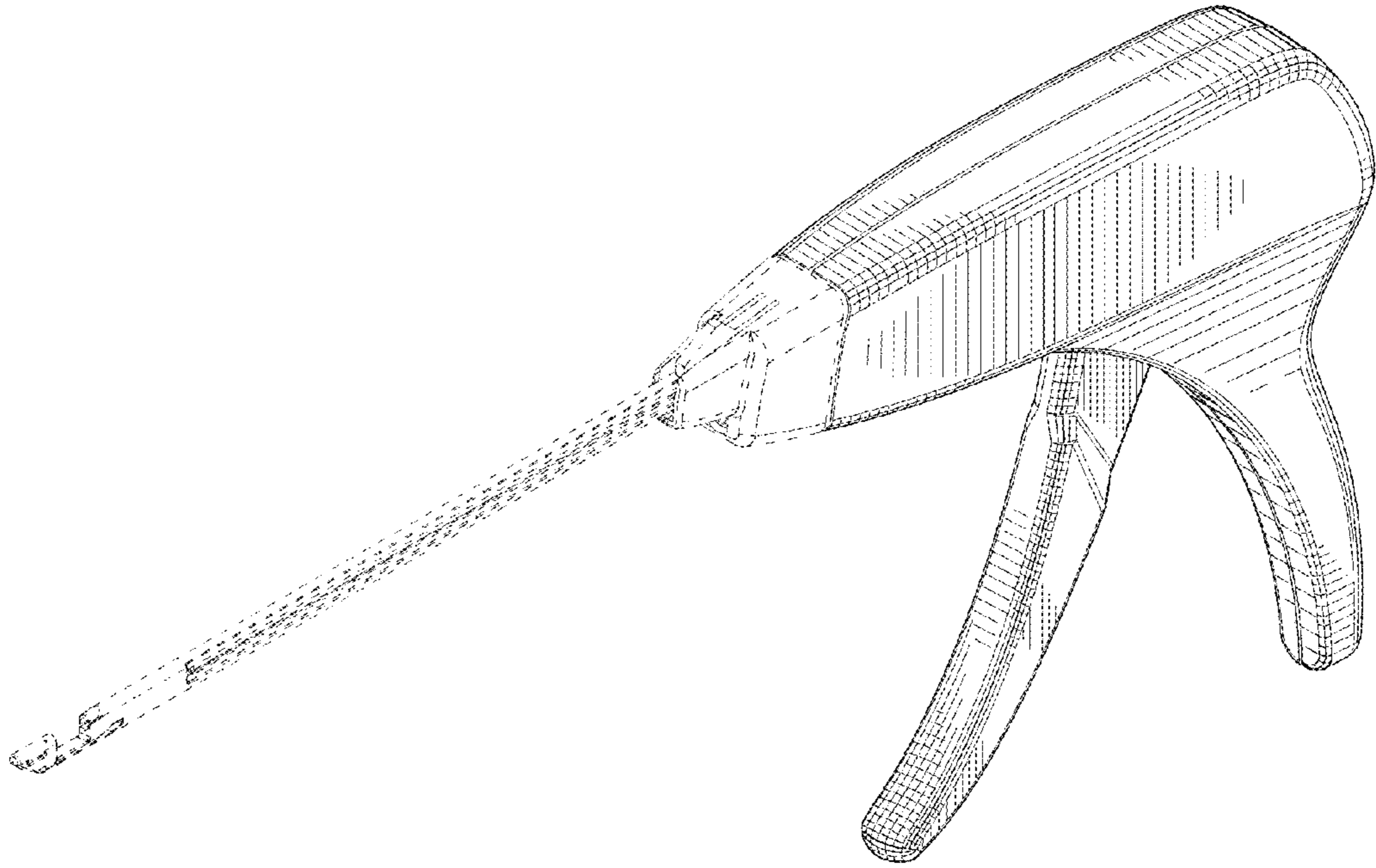
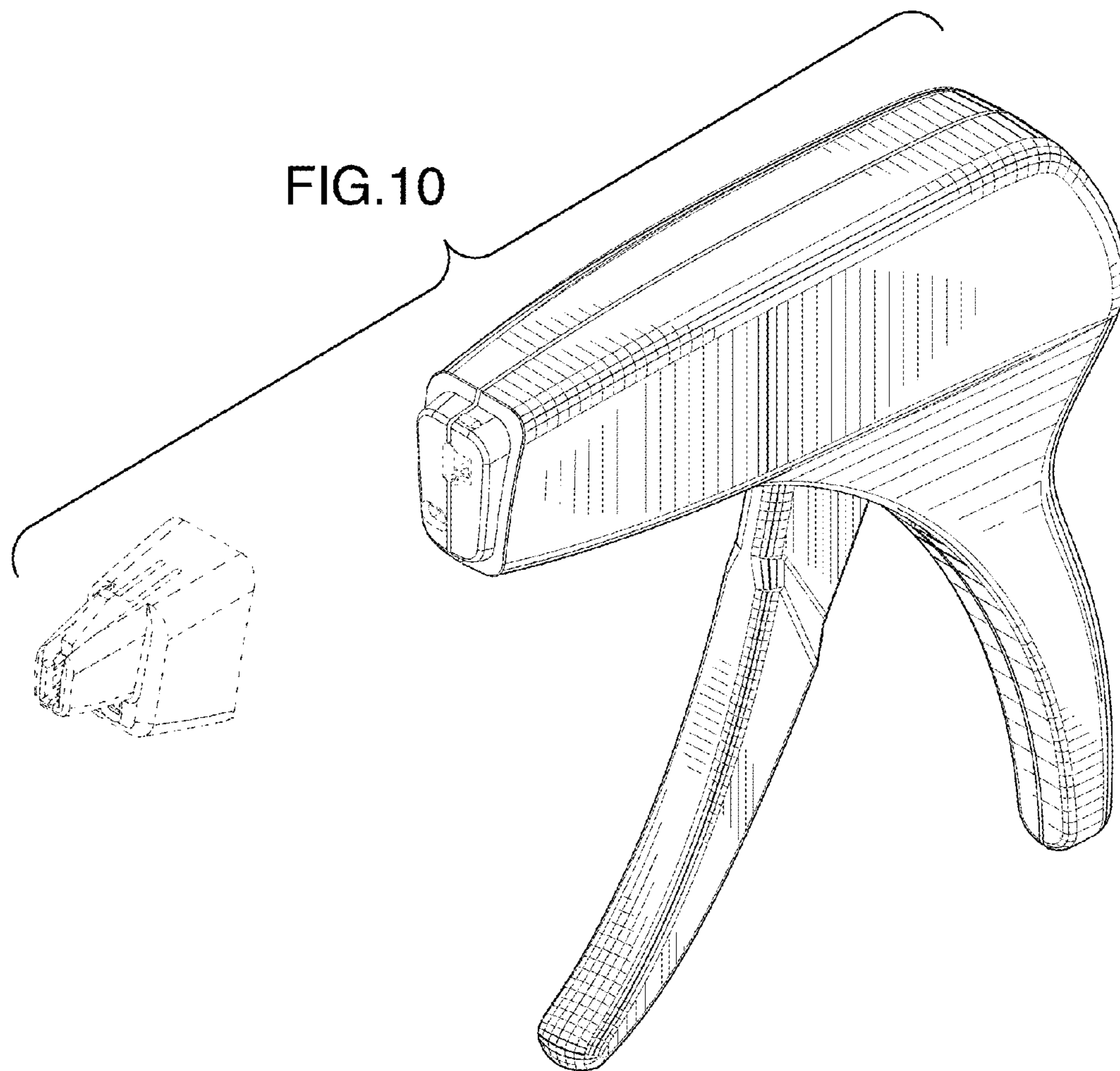

FIG.9



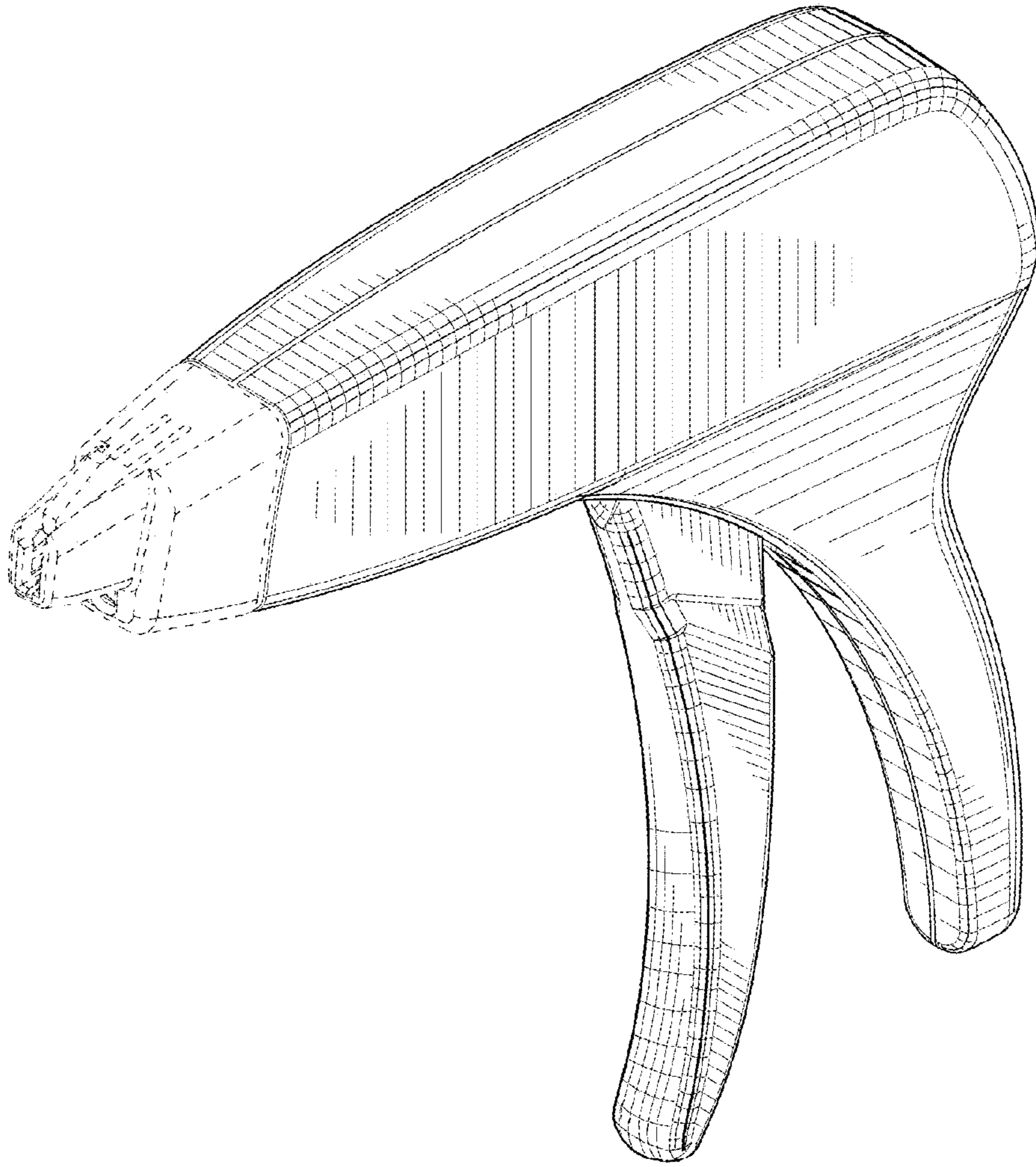

FIG.11

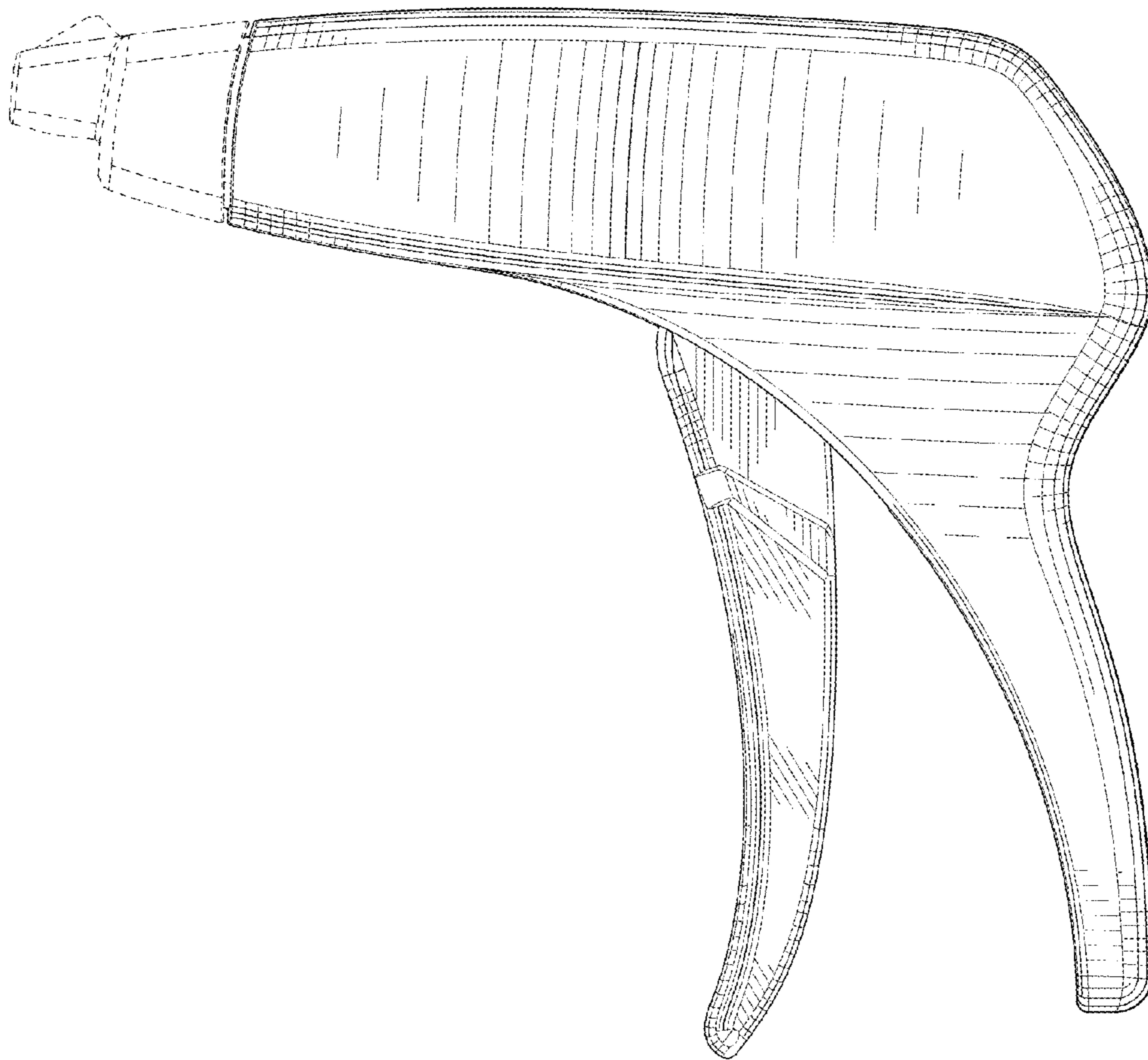

FIG.12

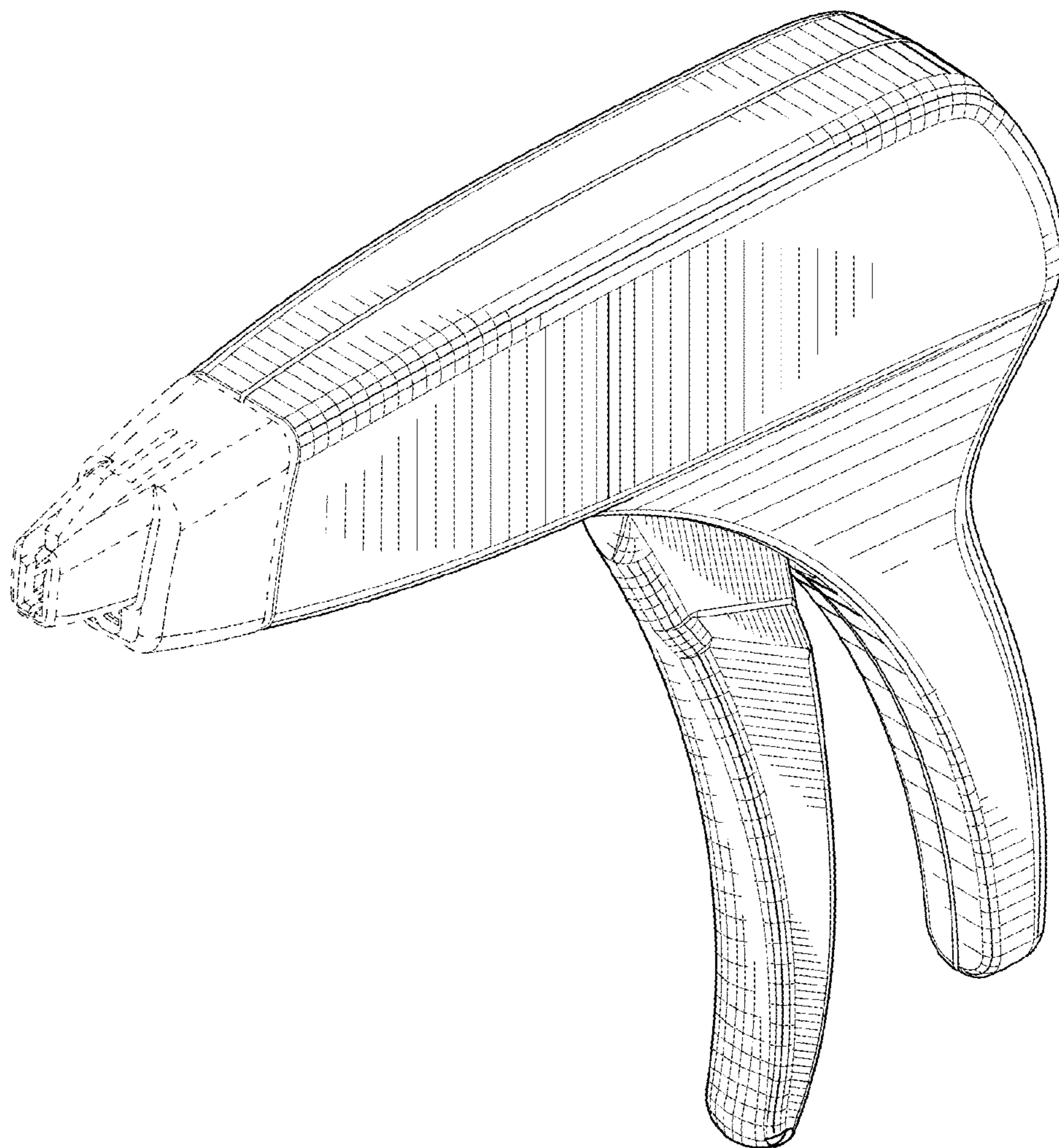

FIG.13

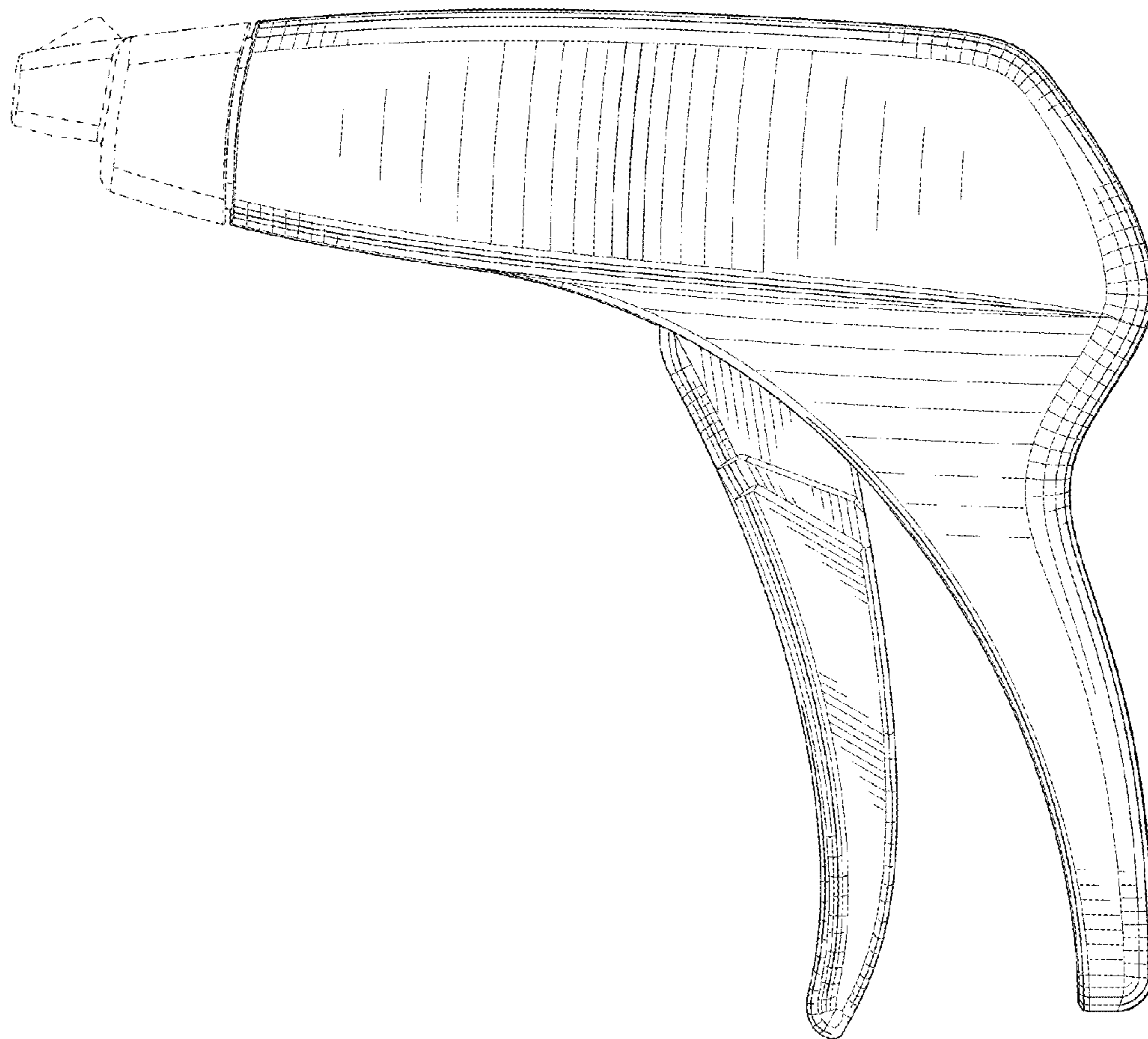

FIG.14