



US00D733276S

(12) **United States Design Patent**
Inoue et al.

(10) **Patent No.:** **US D733,276 S**
(45) **Date of Patent:** **** Jun. 30, 2015**

(54) **PARTICULATE FILTER**

(71) Applicant: **SUMITOMO CHEMICAL COMPANY, LIMITED**, Chuo-ku, Tokyo (JP)

(72) Inventors: **Masashi Inoue**, Niihama (JP); **Tatsuya Naito**, Niihama (JP); **Hiroyuki Ikawa**, Niihama (JP)

(73) Assignee: **SUMITOMO CHEMICAL COMPANY, LIMITED**, Tokyo (JP)

(**) Term: **14 Years**

(21) Appl. No.: **29/476,793**

(22) Filed: **Dec. 17, 2013**

(30) **Foreign Application Priority Data**

Jun. 18, 2013 (JP) 2013-013746

(51) **LOC (10) Cl.** **23-04**

(52) **U.S. Cl.**
USPC **D23/365**

(58) **Field of Classification Search**
USPC D23/365, 209, 363, 358, 386, 354, 341, D23/364; 55/385.3, 502, 497, 506, 505, 55/521, 495, 422, 493, DIG. 30; 210/435, 210/130, 136, 248, 339, 448, 452, 497.1; D32/31; D15/5

See application file for complete search history.

(56) **References Cited**

U.S. PATENT DOCUMENTS

D519,197 S * 4/2006 Komori et al. D23/365
D522,117 S * 5/2006 Komori et al. D23/365
D534,264 S * 12/2006 Komori et al. D23/365
D538,911 S * 3/2007 Komori et al. D23/365
7,648,549 B2 * 1/2010 Gargano et al. 55/523
D609,319 S * 2/2010 Ohno et al. D23/365

D609,320 S * 2/2010 Ohno et al. D23/365
7,964,263 B2 * 6/2011 Kodama et al. 428/116
D647,607 S * 10/2011 Ohno et al. D23/365
D675,718 S * 2/2013 Komori et al. D23/365
D676,120 S * 2/2013 Komori et al. D23/365
D676,121 S * 2/2013 Komori et al. D23/365
D700,693 S * 3/2014 Komori et al. D23/365

* cited by examiner

Primary Examiner — David Muller

(74) *Attorney, Agent, or Firm* — Sughrue Mion, PLLC

(57) **CLAIM**

The ornamental design for a particulate filter, as shown and described.

DESCRIPTION

FIG. 1 is a front view of a particulate filter of the present invention;

FIG. 2 is a rear view thereof;

FIG. 3 is a top plan view thereof;

FIG. 4 is a bottom view thereof;

FIG. 5 is a right side view thereof;

FIG. 6 is a left side view thereof;

FIG. 7 is a perspective view thereof;

FIG. 8 is an enlarged left side view thereof, taken along the line VIII-VIII of FIG. 6;

FIG. 9 is an enlarged right side view thereof, taken along the line IX-IX of FIG. 5;

FIG. 10 is a sectional view thereof, taken along the line X-X of FIG. 6;

FIG. 11 is an enlarged sectional view thereof, taken along the line XI-XI of FIG. 10;

FIG. 12 is an enlarged sectional view thereof, taken along the line XII-XII of FIG. 10;

FIG. 13 is a section view thereof, taken along the line XIII-XIII of FIG. 1; and,

FIG. 14 is an enlarged section view thereof, taken along the line XIV-XIV of FIG. 13.

1 Claim, 14 Drawing Sheets

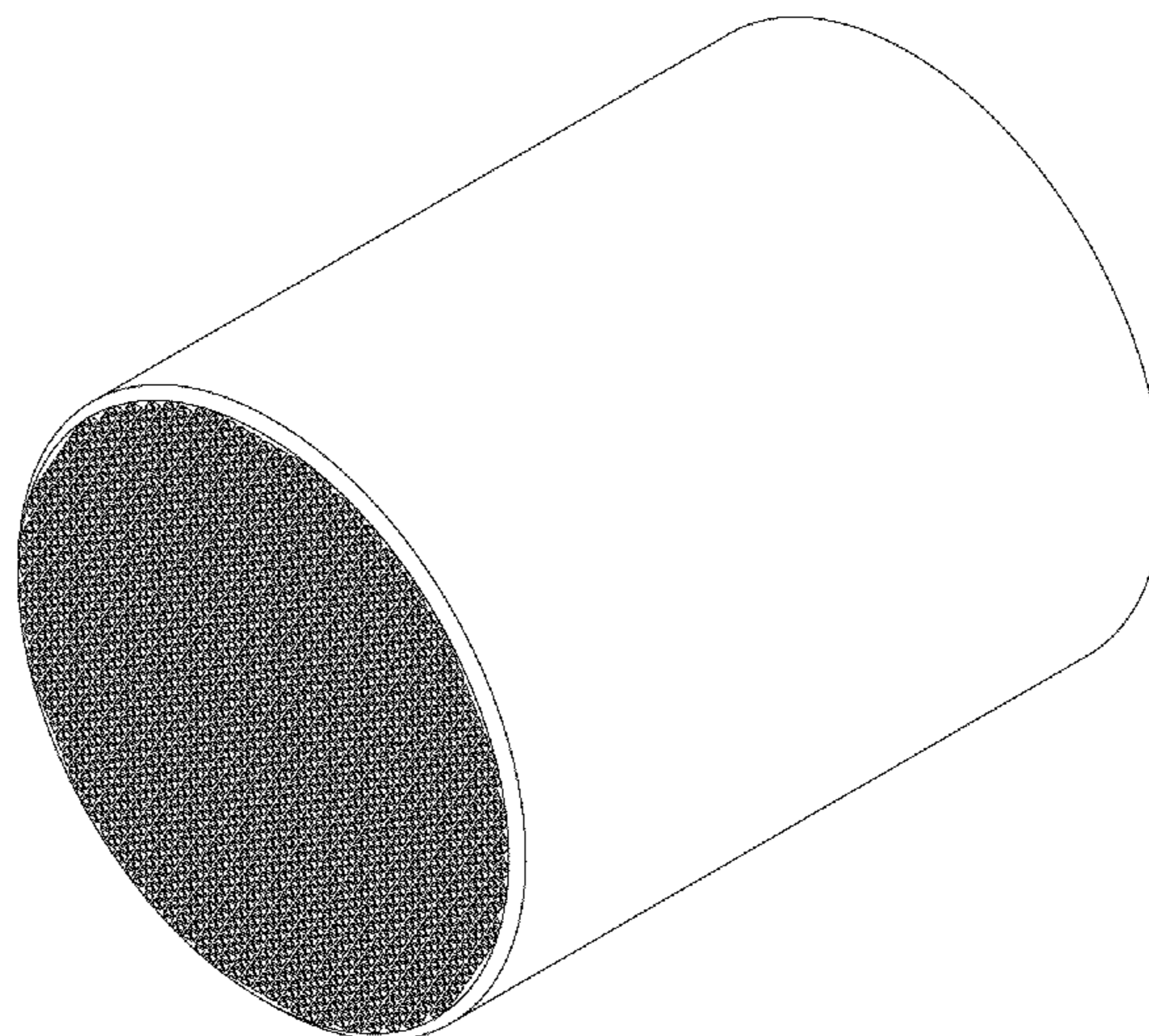

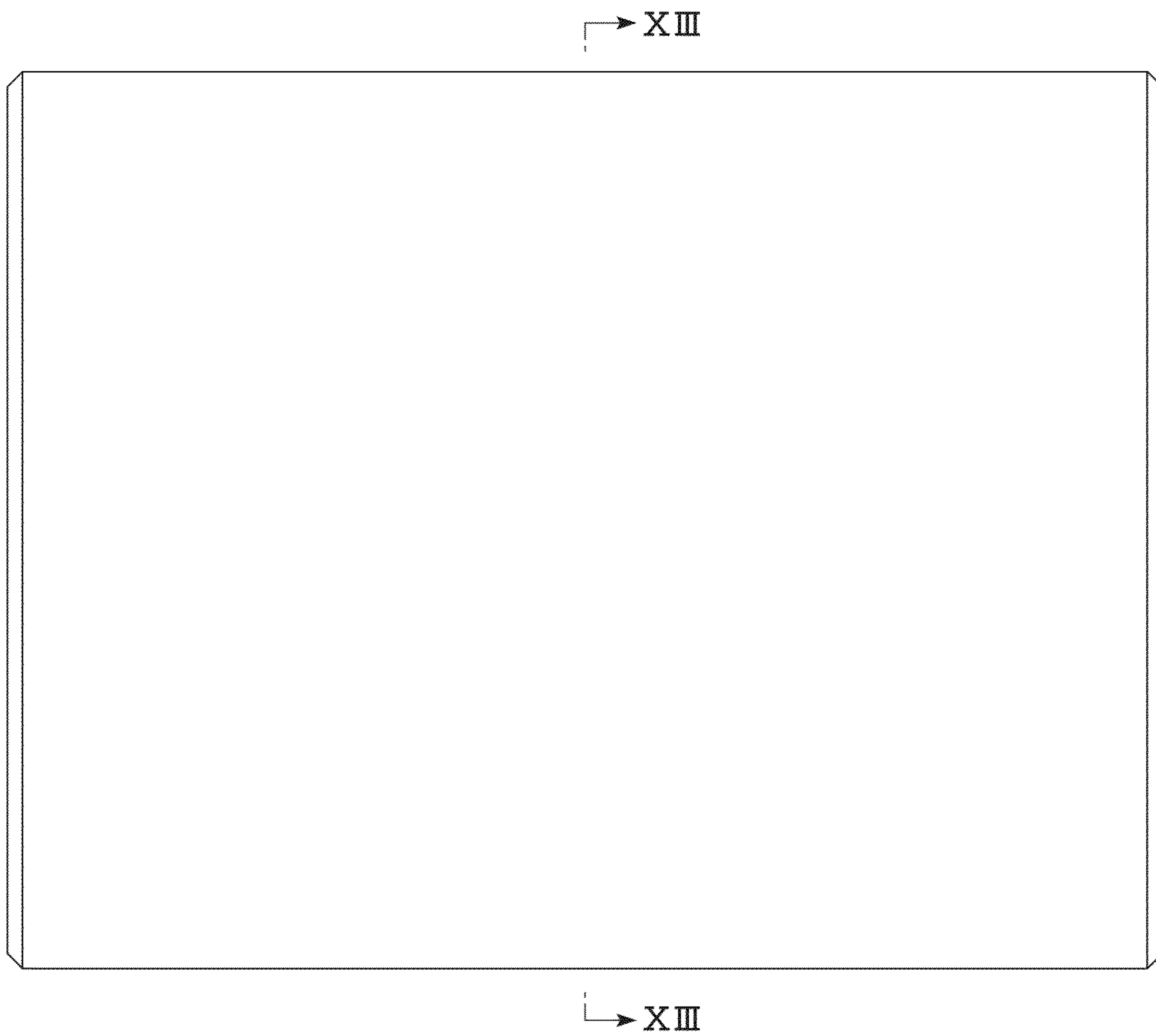

FIG.1



FIG.2

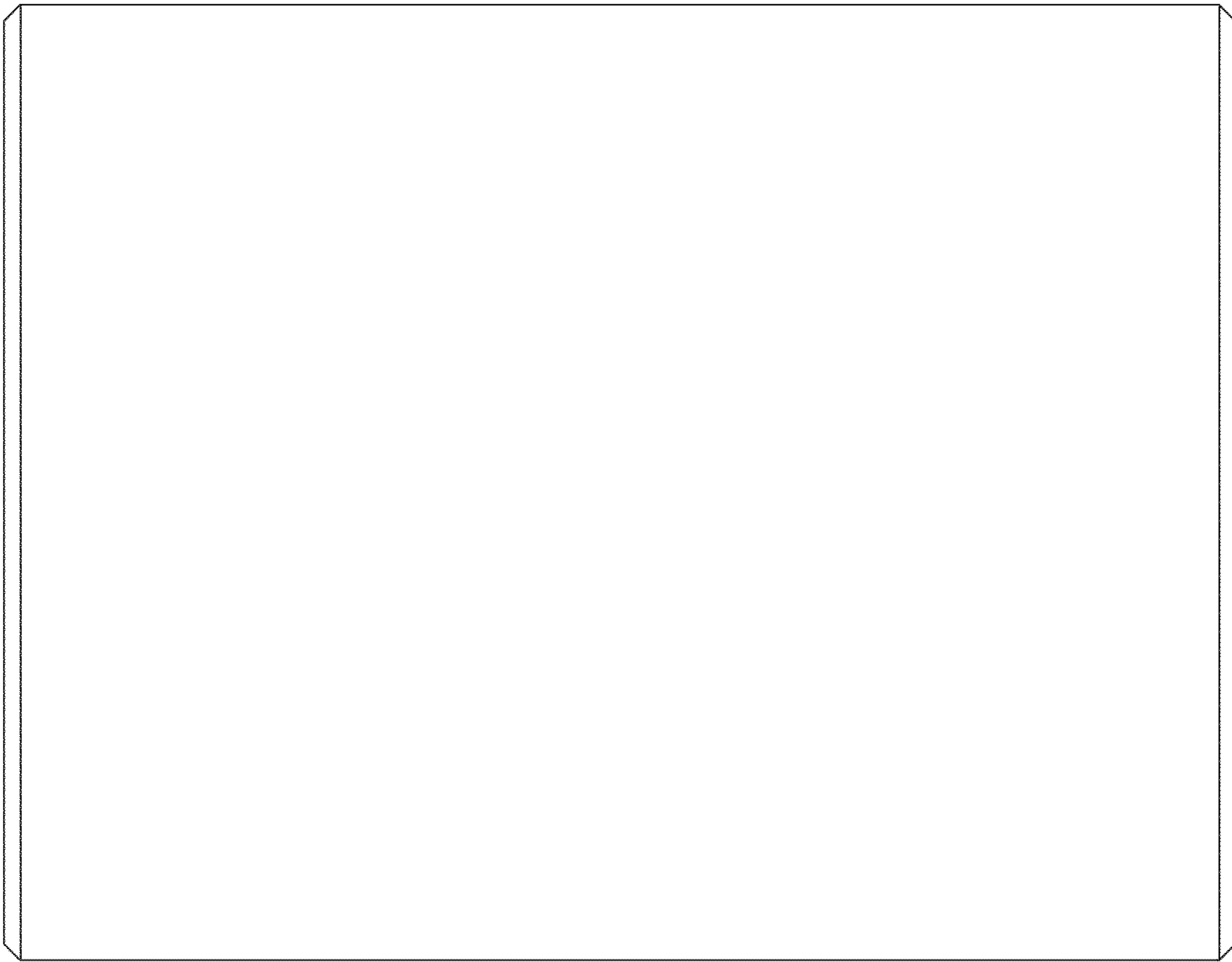

FIG.3

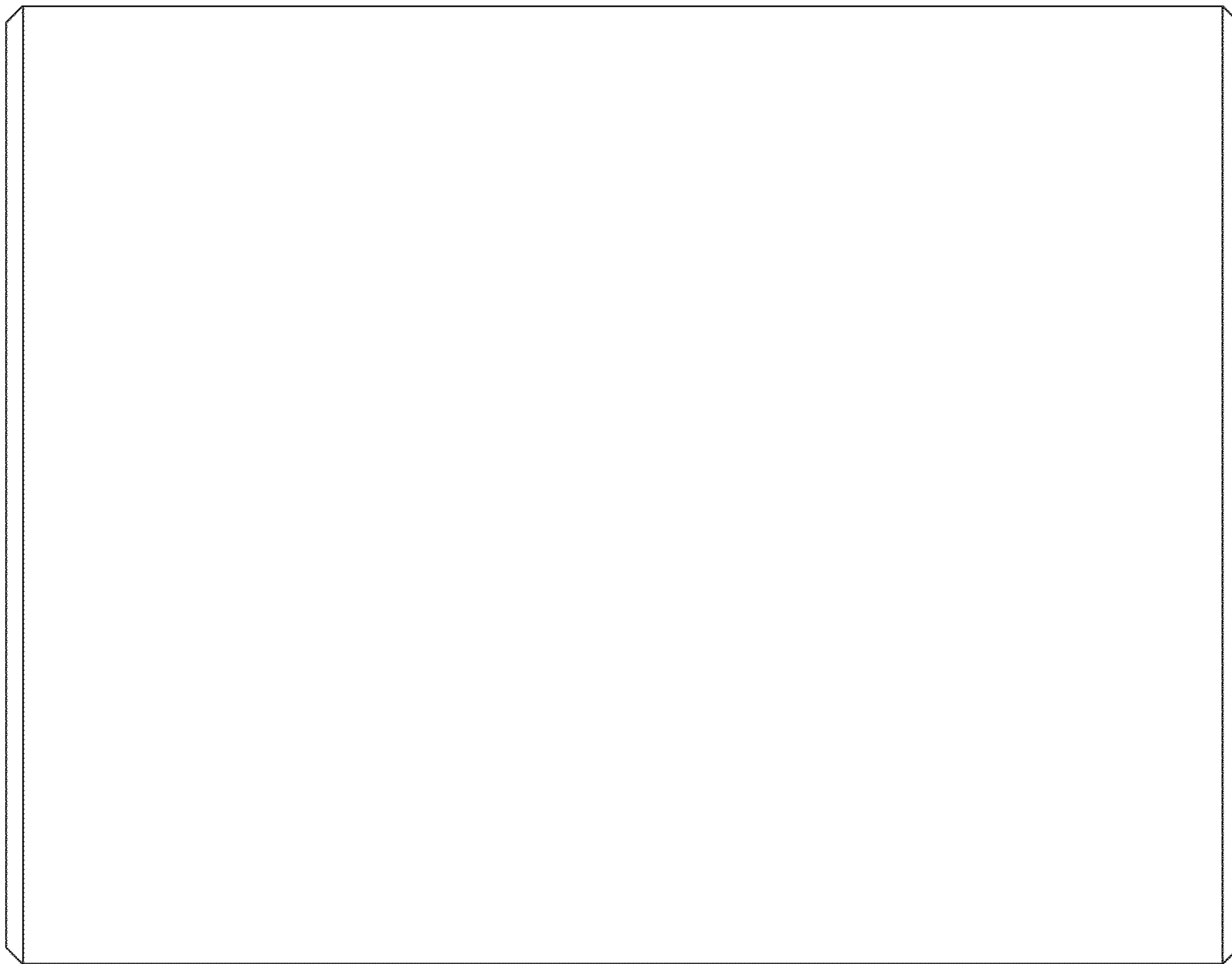

FIG.4

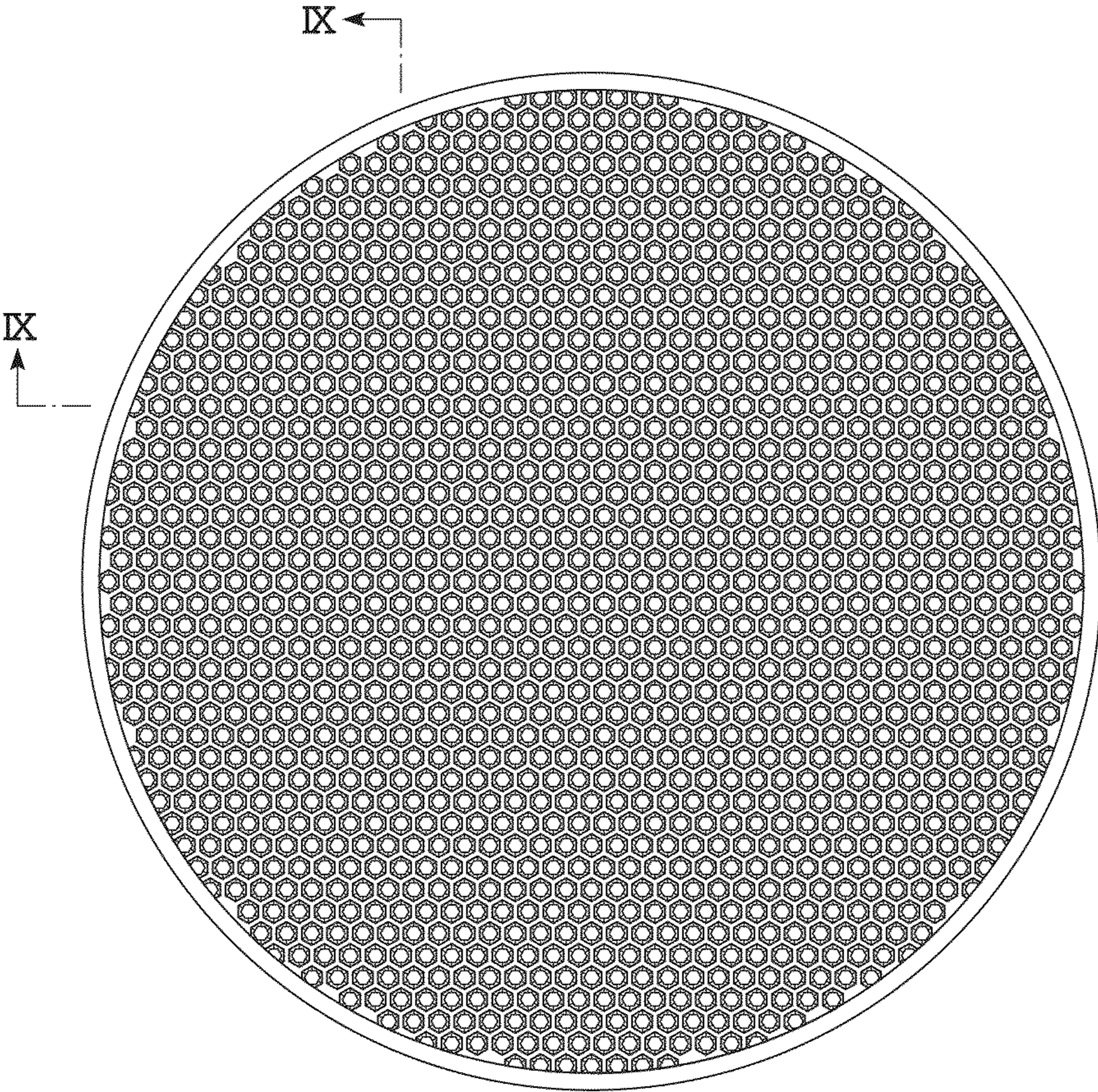

FIG.5

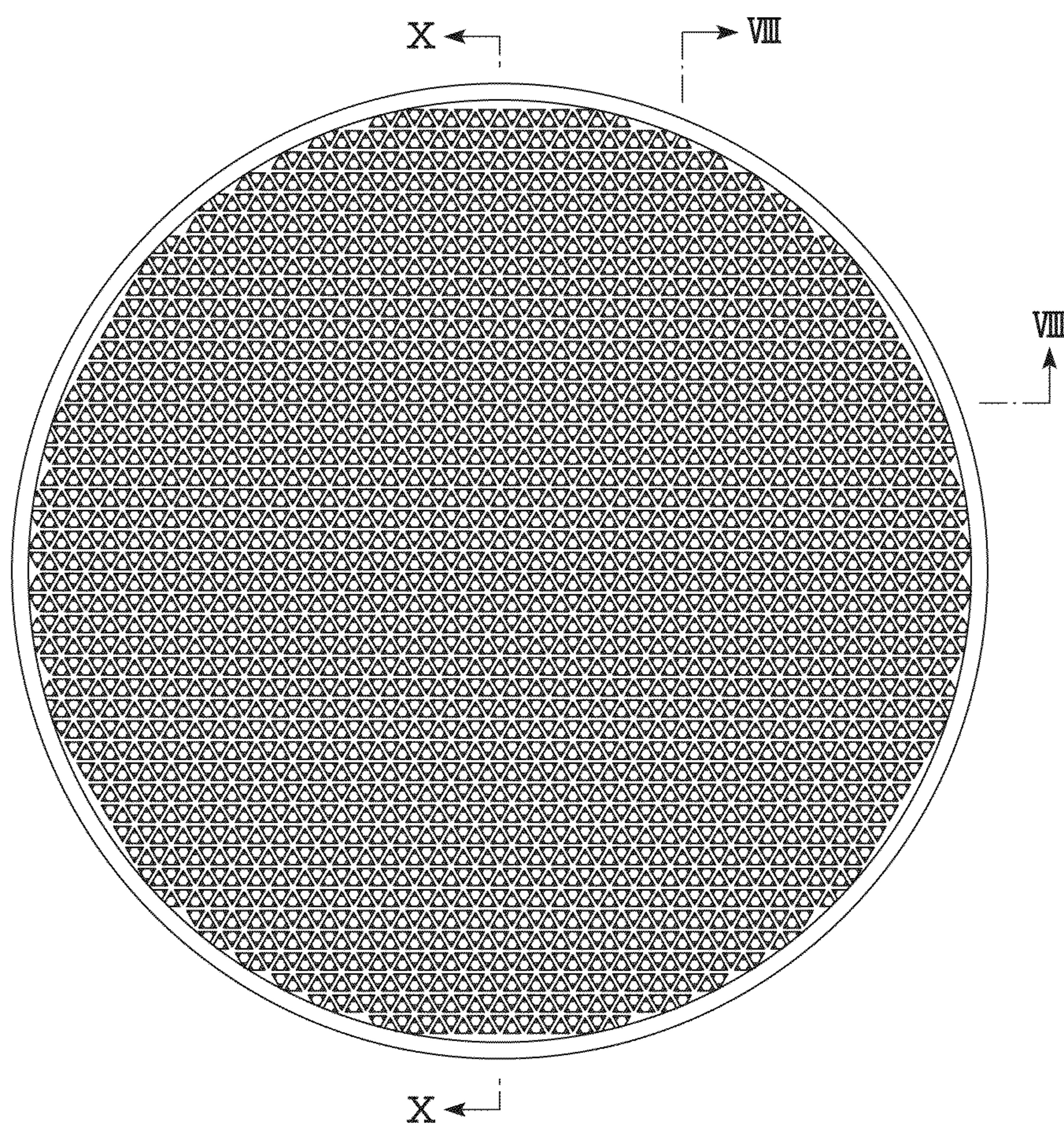

FIG.6

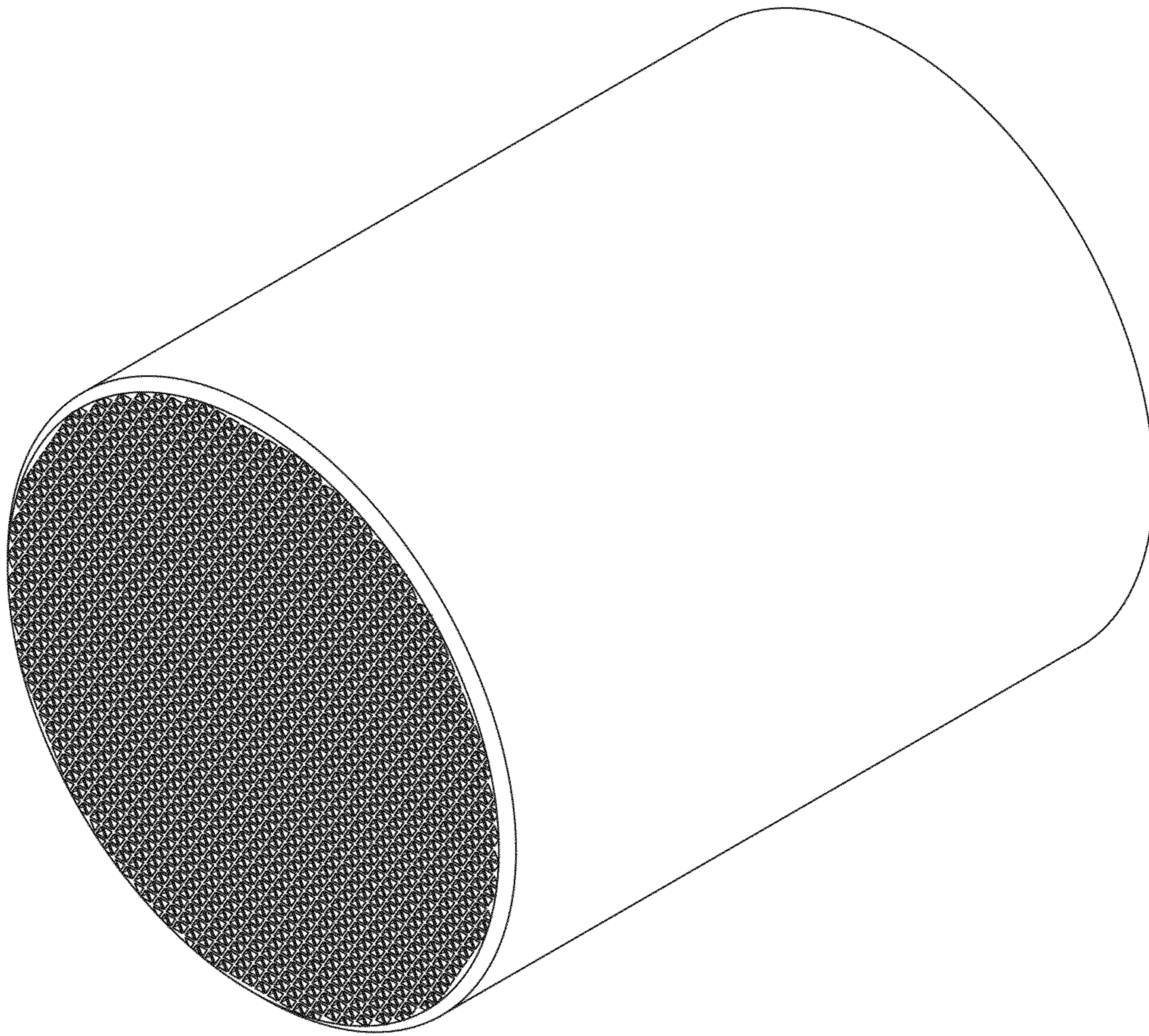

FIG.7

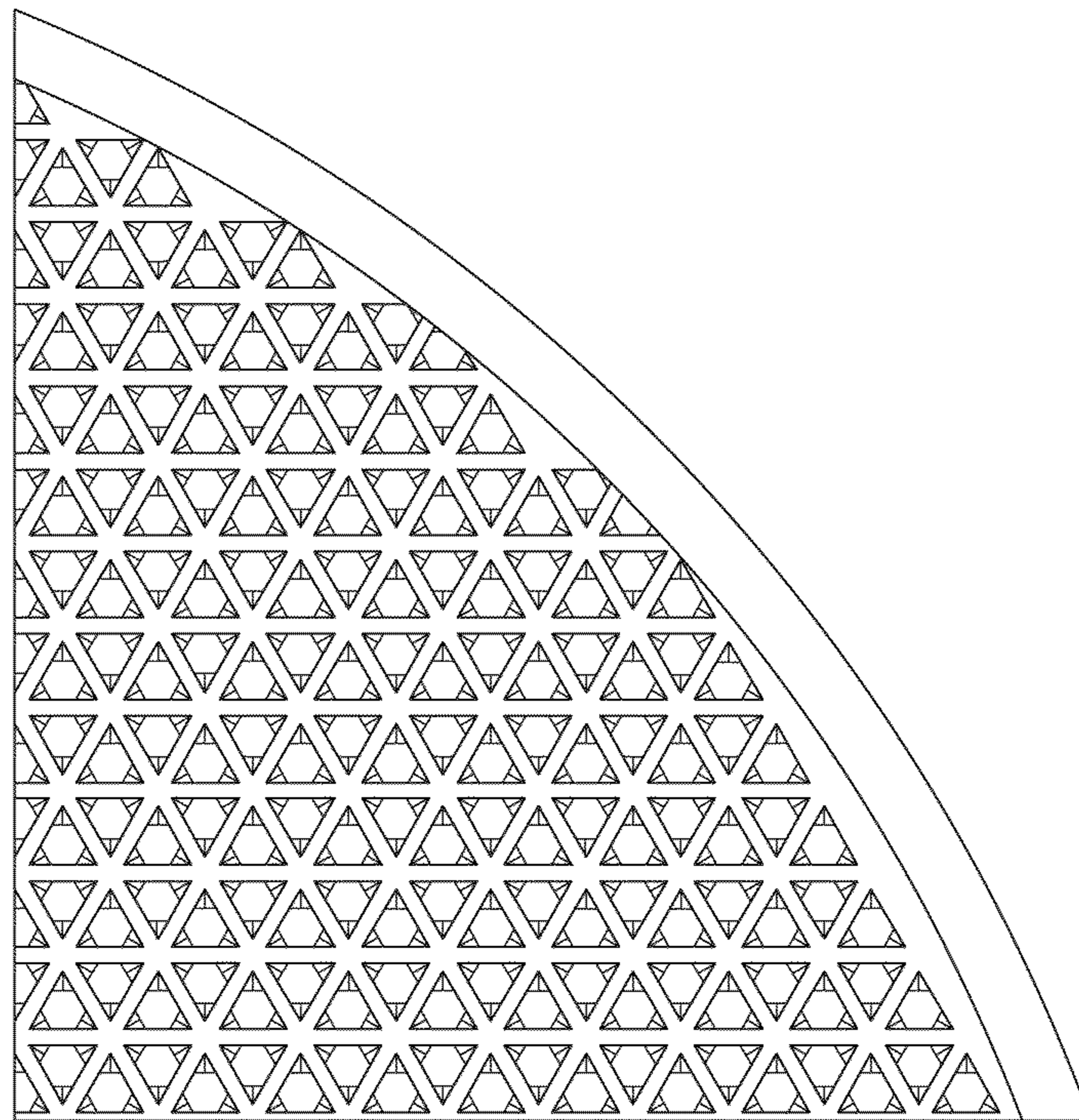

FIG.8

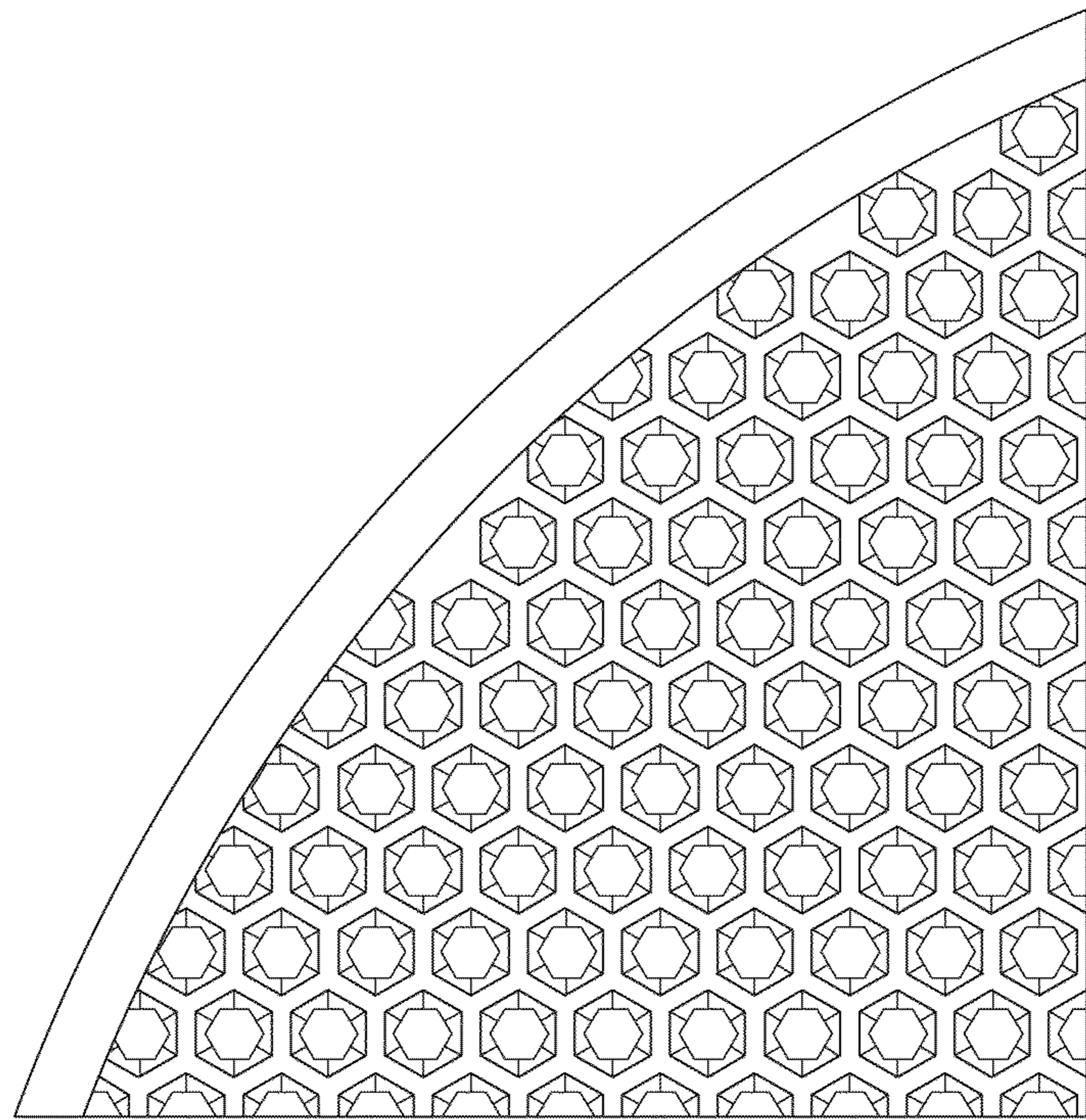

FIG.9

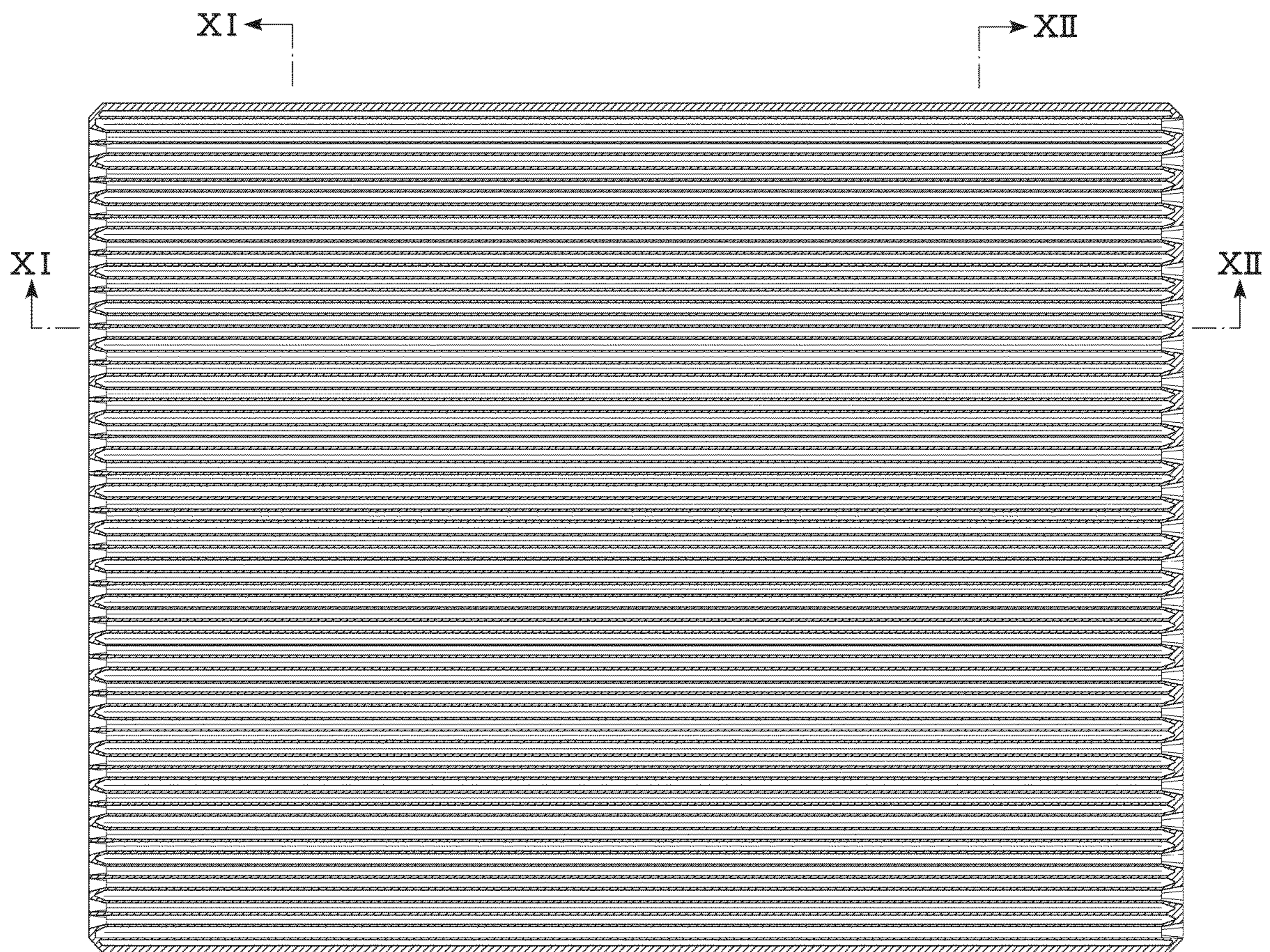

FIG.10

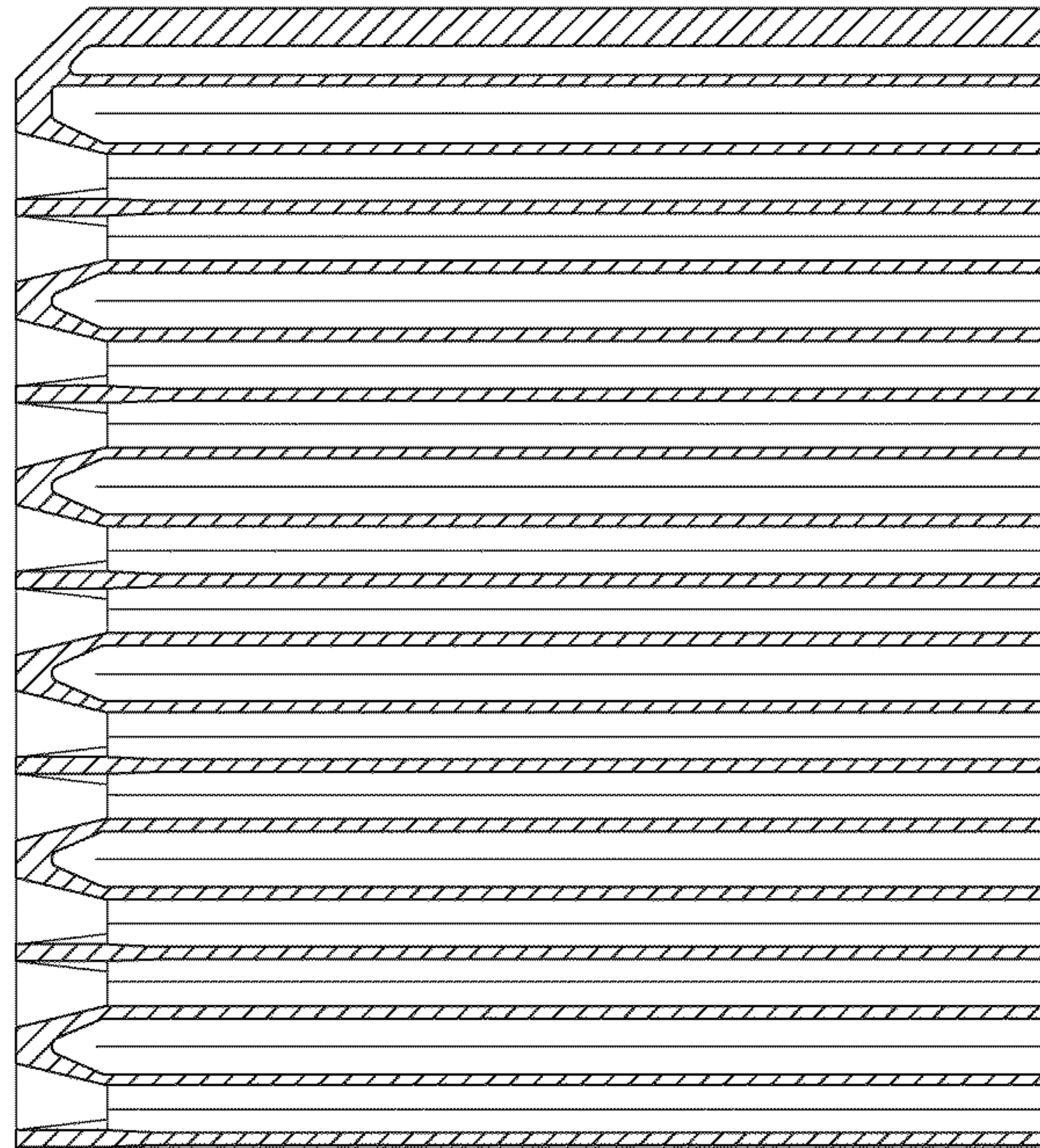

FIG.11

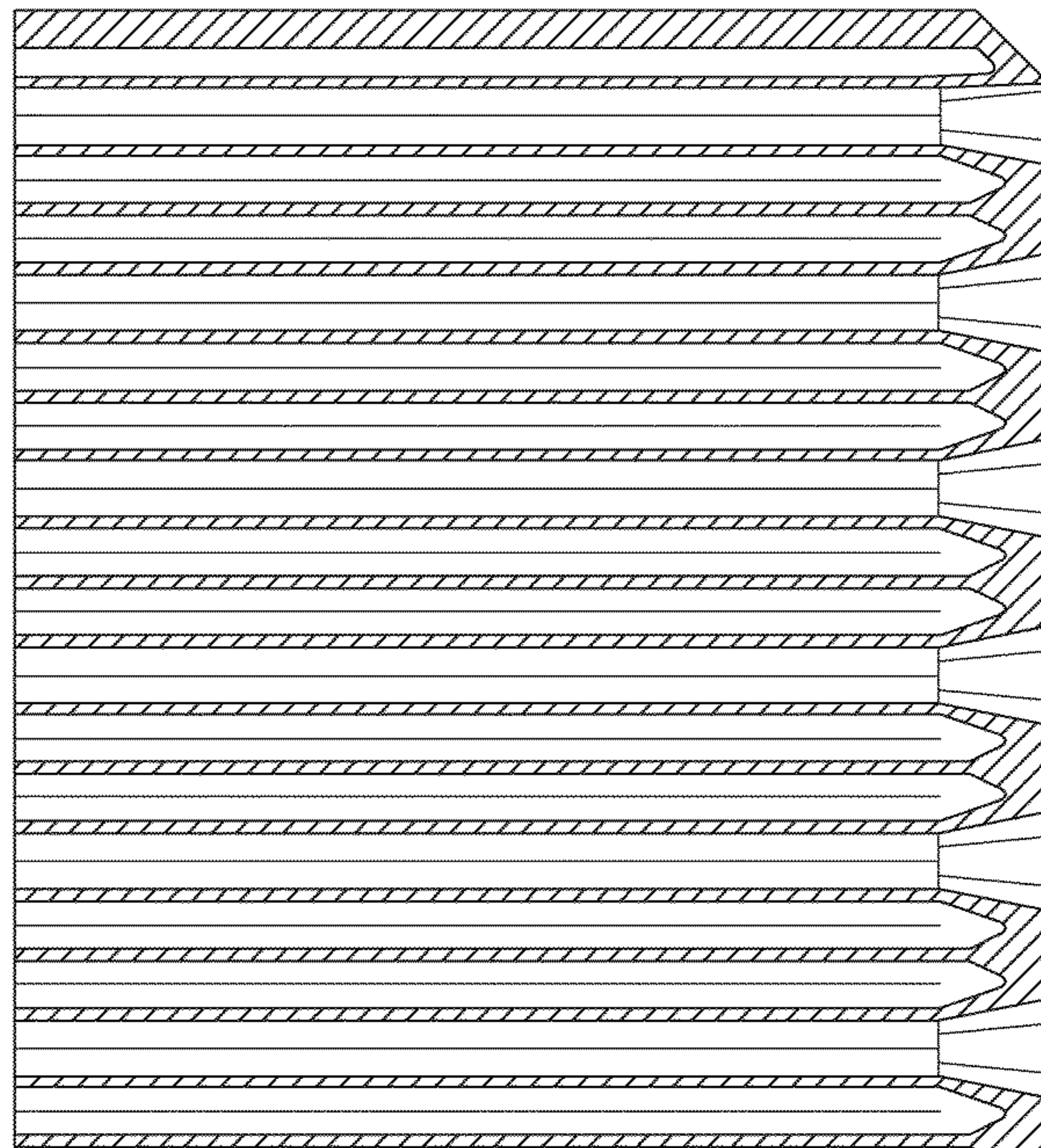

FIG.12

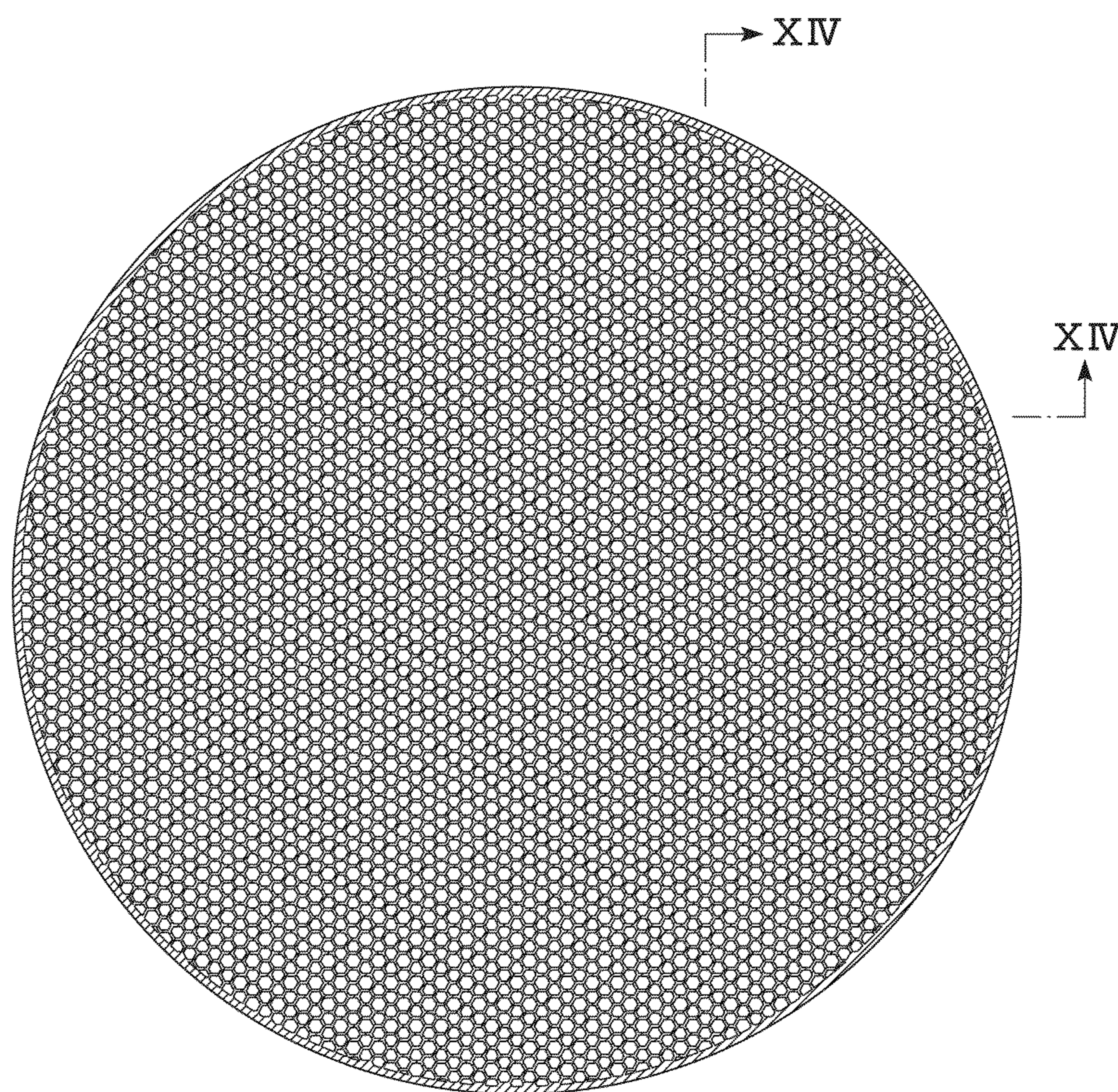

FIG.13

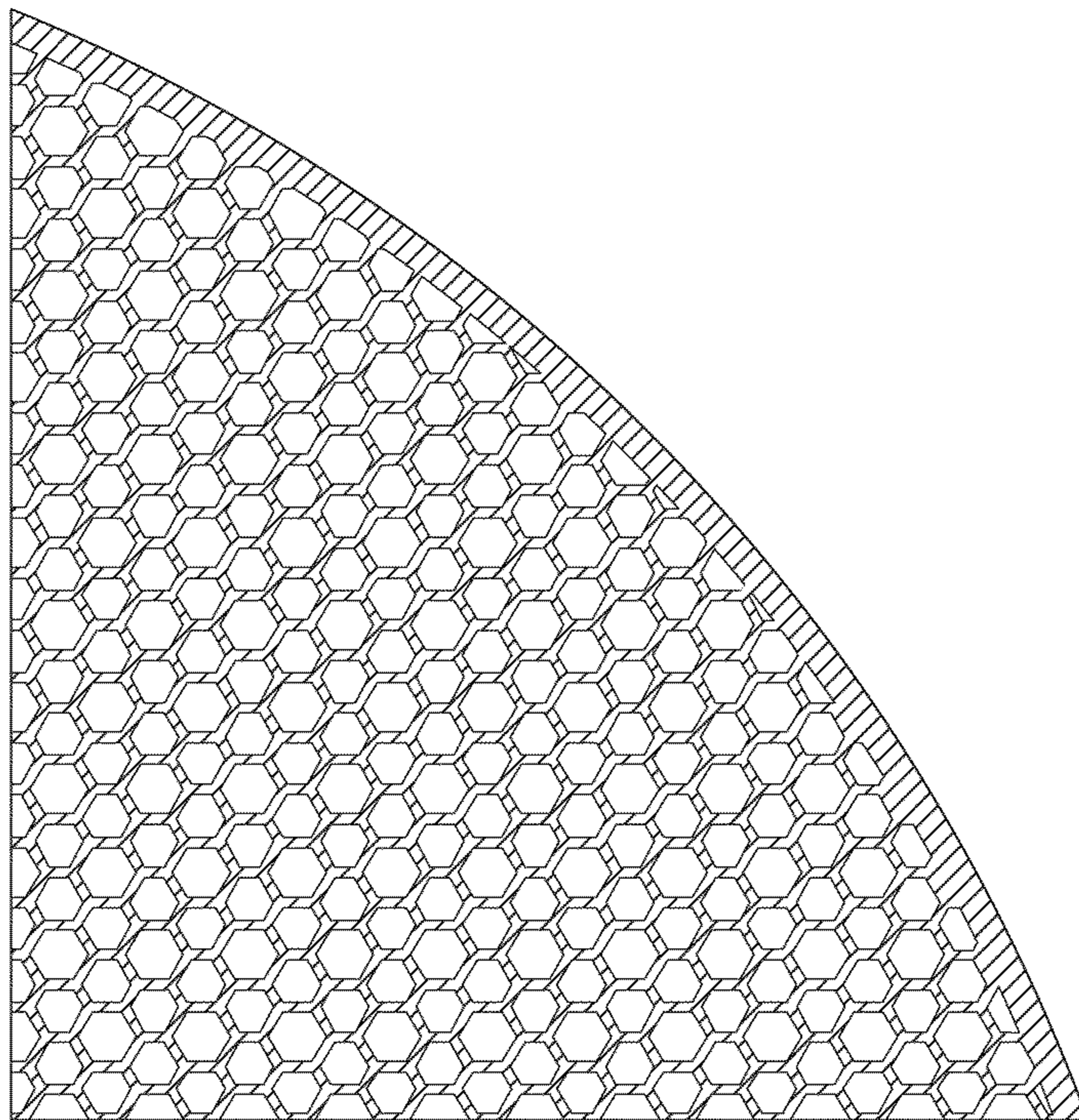

FIG.14