



US00D733258S

(12) **United States Design Patent**
Sandee

(10) **Patent No.:** **US D733,258 S**
(45) **Date of Patent:** **** Jun. 30, 2015**

- (54) **SHOWERHEAD**
- (71) Applicant: **Kohler Co.**, Kohler, WI (US)
- (72) Inventor: **Coralee Schroeder Sandee**, Sheboygan, WI (US)
- (73) Assignee: **KOHLER CO.**, Kohler, WI (US)
- (**) Term: **14 Years**
- (21) Appl. No.: **29/498,039**
- (22) Filed: **Jul. 30, 2014**

D608,413 S	1/2010	Barnard et al.	
D609,777 S *	2/2010	Wu et al.	D23/223
D610,230 S *	2/2010	Wu et al.	D23/223
D610,231 S *	2/2010	Wu et al.	D23/223
D610,651 S *	2/2010	Wu et al.	D23/223
D655,384 S *	3/2012	Schoenherr et al.	D23/223
D672,011 S *	12/2012	Andrew et al.	D23/223
D680,619 S *	4/2013	Zhadanov	D23/223
D694,361 S *	11/2013	Schoenherr et al.	D23/223
D696,383 S *	12/2013	Miller et al.	D23/223
2013/0092752 A1	4/2013	Schumacher et al.	
2013/0232684 A1	9/2013	Schumacher et al.	

* cited by examiner

Primary Examiner — Robin V Webster

(74) *Attorney, Agent, or Firm* — Foley & Lardner LLP

Related U.S. Application Data

- (62) Division of application No. 29/452,523, filed on Apr. 17, 2013, now Pat. No. Des. 713,003.
- (51) **LOC (10) Cl.** **23-01**
- (52) **U.S. Cl.**
USPC **D23/223**
- (58) **Field of Classification Search**
USPC D23/213, 229, 230, 223, 226; 239/282, 239/283, 548, 462; 4/615
See application file for complete search history.

(57) **CLAIM**

I claim the ornamental design for a showerhead, as shown and described.

DESCRIPTION

FIG. 1 is a top, right, front perspective view of an embodiment of the claimed design;
 FIG. 2 is a bottom, right, rear perspective view thereof;
 FIG. 3 is a bottom plan view thereof;
 FIG. 4 is a top plan view thereof;
 FIG. 5 is front elevation view thereof;
 FIG. 6 is a rear elevation view thereof;
 FIG. 7 is a right elevation view thereof; and,
 FIG. 8 is a left elevation view thereof.

The ornamental design which is claimed is shown in solid lines in the drawings. The broken lines in the drawings are for illustrative purposes only and form no part of the claimed design. Broken lines formed by equal length dashes show unclaimed portions of the design.

1 Claim, 7 Drawing Sheets

(56) **References Cited**

U.S. PATENT DOCUMENTS

D352,347 S	11/1994	Dannenberg
D439,305 S	3/2001	Slothower
D440,276 S	4/2001	Slothower
D440,277 S	4/2001	Slothower
D440,278 S	4/2001	Slothower
D564,626 S	3/2008	Rexach
D607,971 S	1/2010	Barnard et al.
D608,412 S	1/2010	Barnard et al.

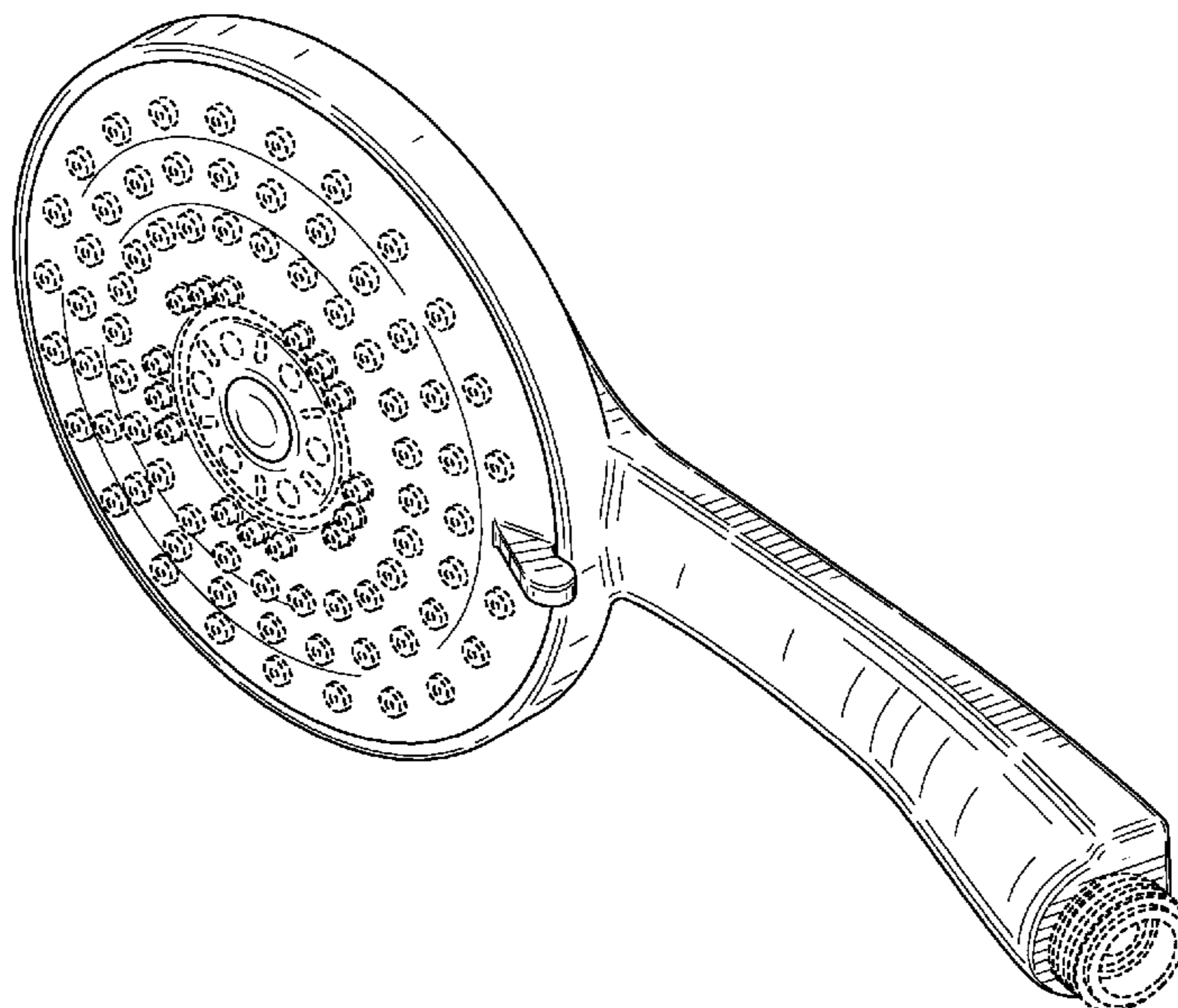

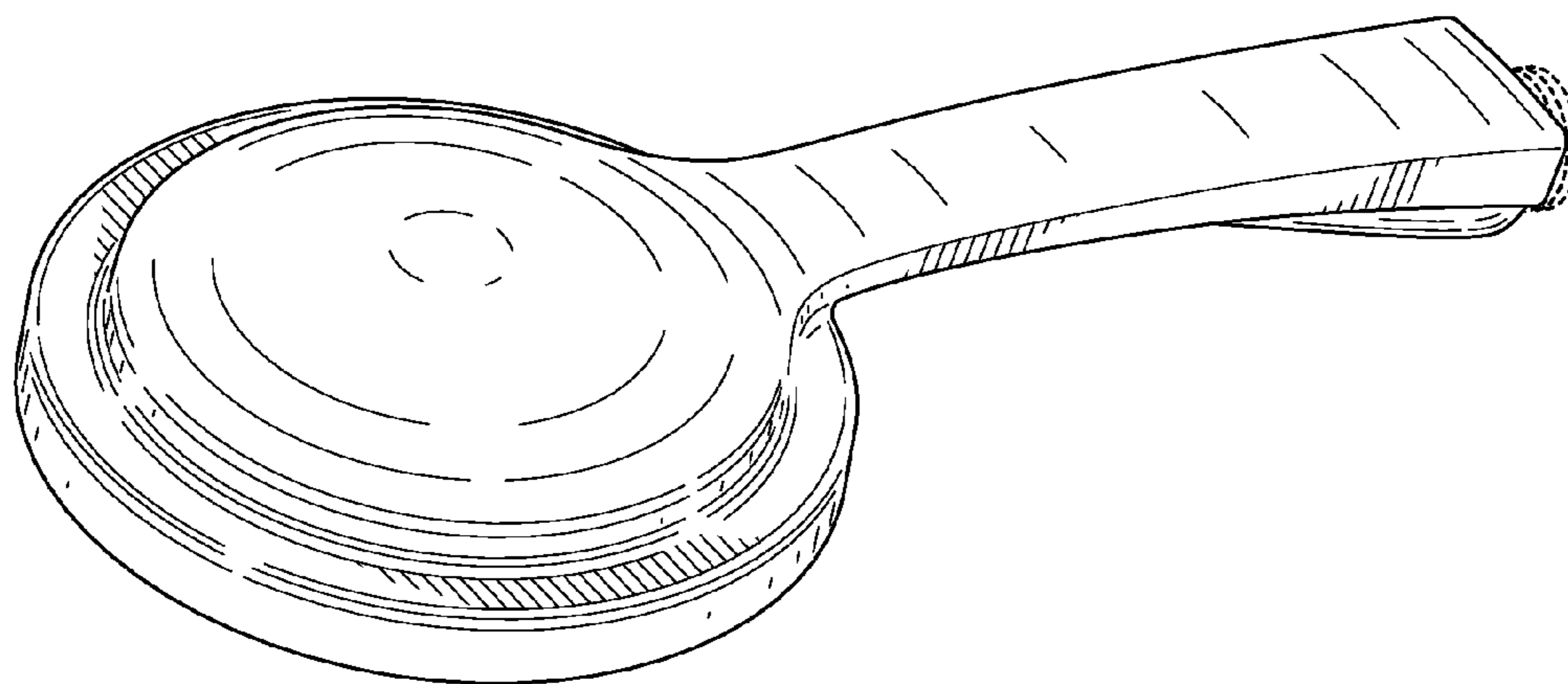

FIG. 1

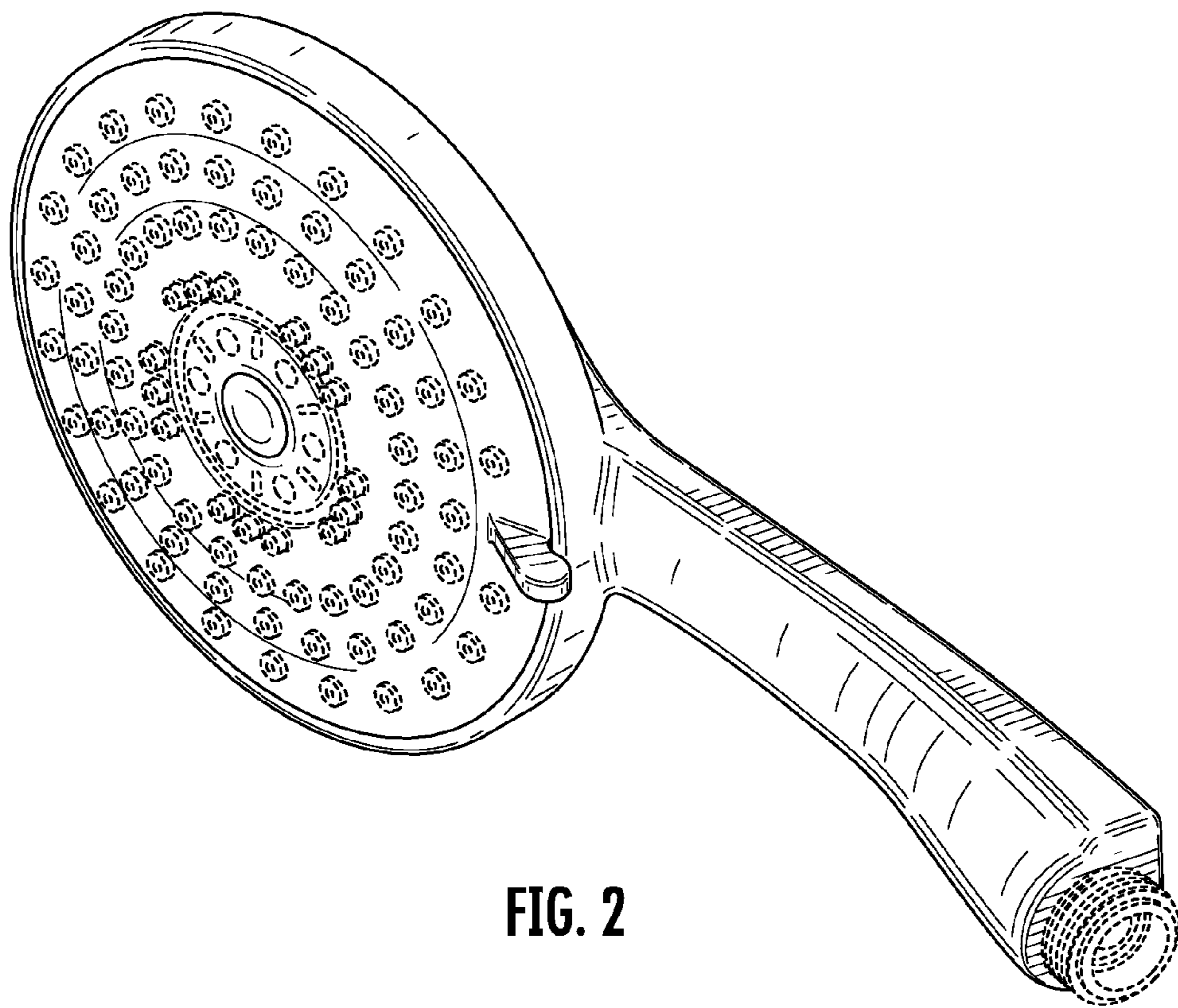

FIG. 2

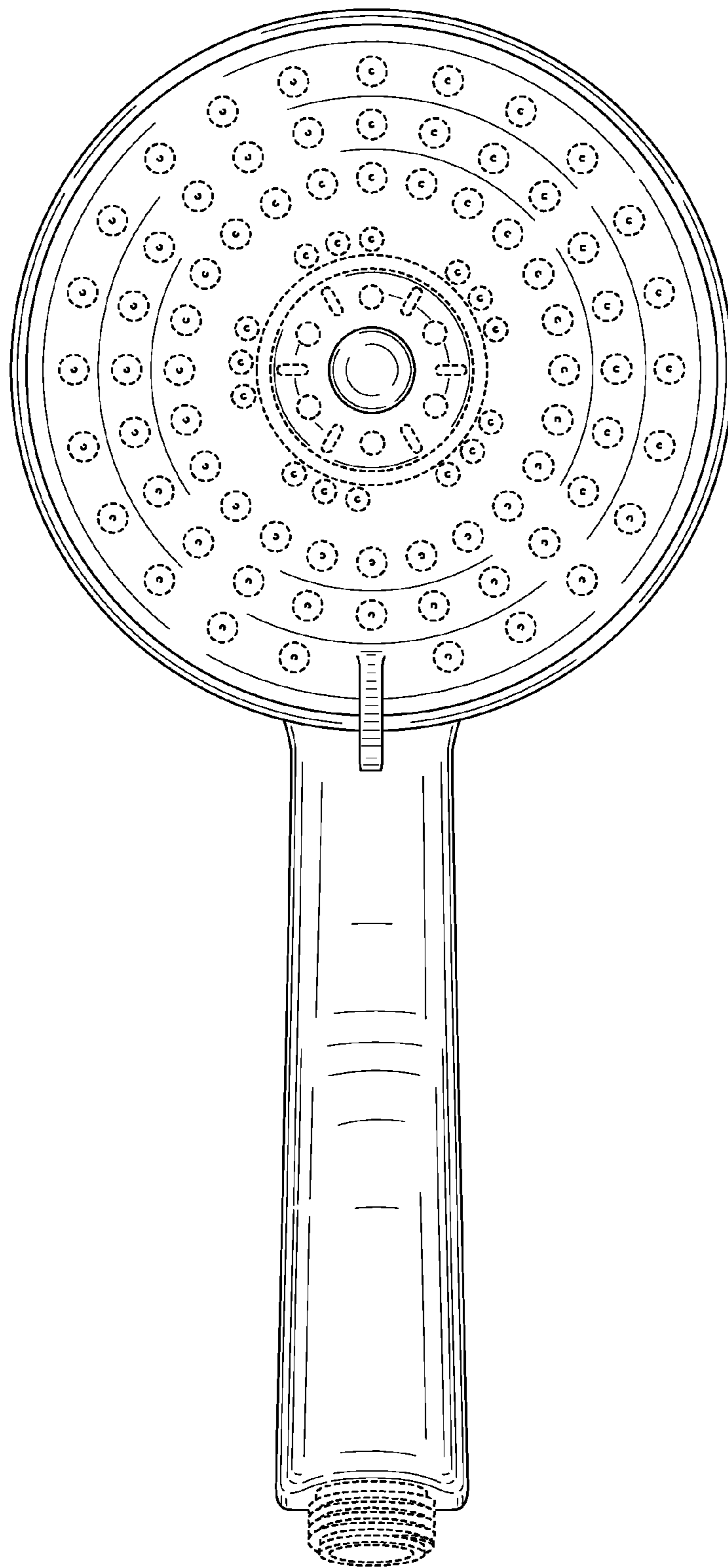

FIG. 3

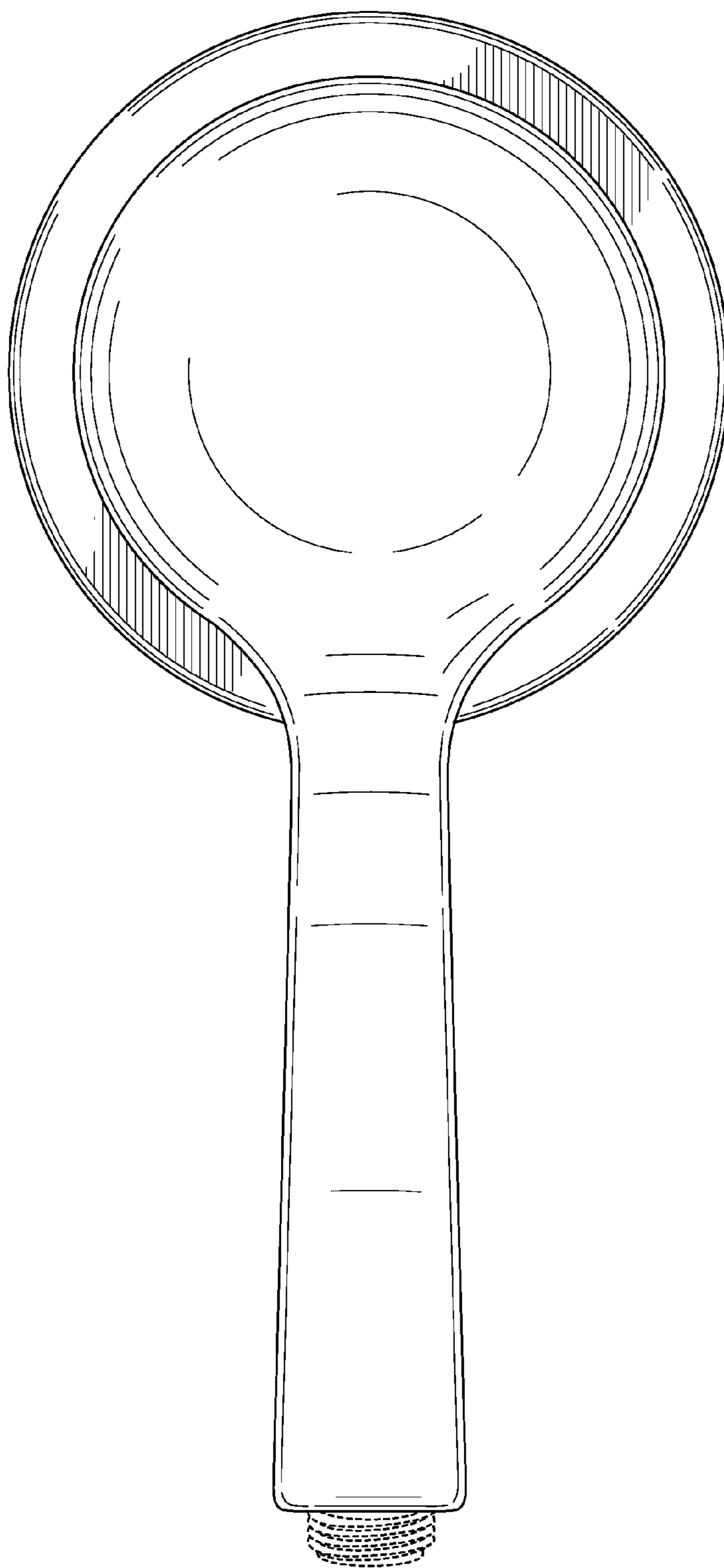

FIG. 4

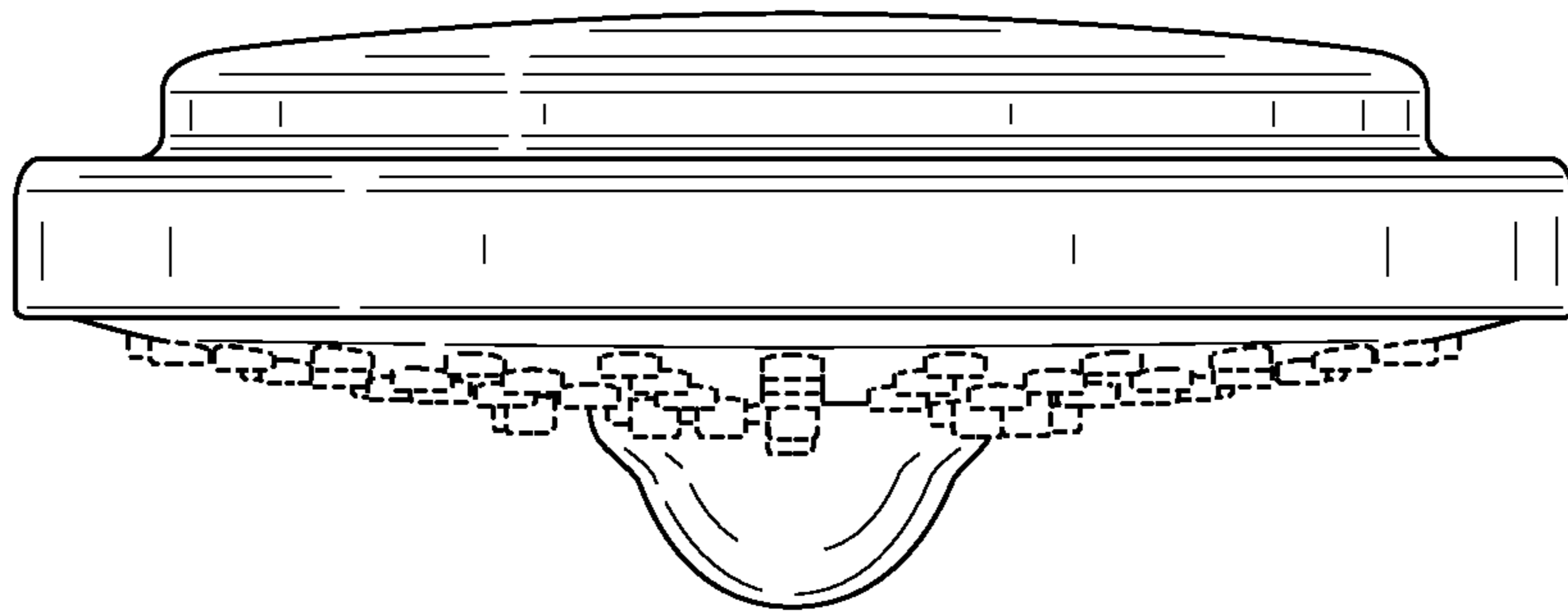

FIG. 5

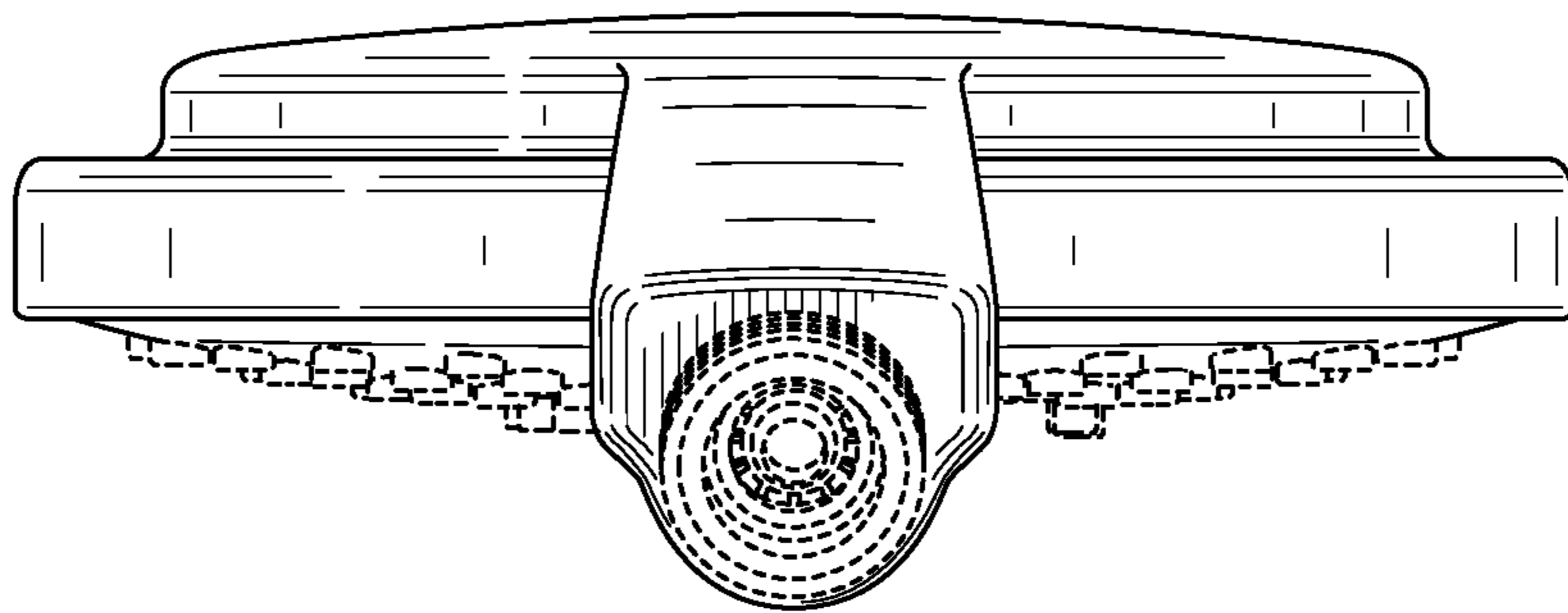

FIG. 6

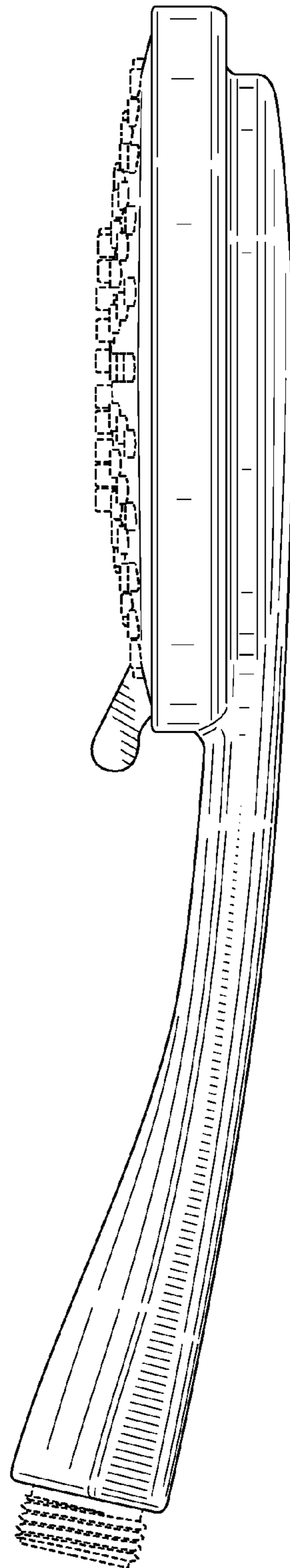

FIG. 7

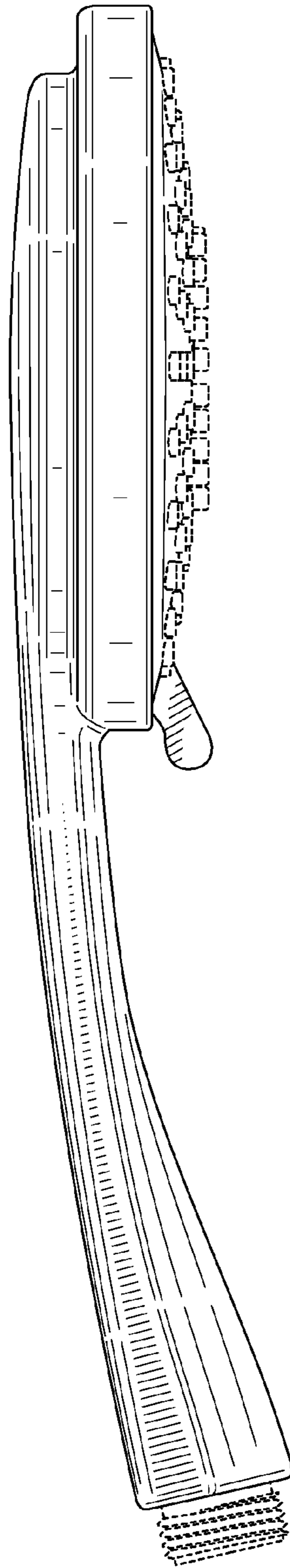

FIG. 8