



US00D733241S

(12) **United States Design Patent**
Fissell

(10) **Patent No.:** **US D733,241 S**
(45) **Date of Patent:** **** Jun. 30, 2015**

- (54) **SKATEBOARD WITH TRANSPARENT WHEEL HAVING AN INNER CORE**
- (71) Applicant: **SUNSET SKATEBOARD COMPANY**,
Newport Beach, CA (US)
- (72) Inventor: **Jeremy Fissell**, San Luis Obispo, CA
(US)
- (73) Assignee: **SUNSET SKATEBOARD COMPANY**,
Newport Beach, CA (US)
- (**) Term: **14 Years**
- (21) Appl. No.: **29/480,699**
- (22) Filed: **Jan. 28, 2014**

Related U.S. Application Data

- (62) Division of application No. 29/455,258, filed on May 17, 2013.
- (51) **LOC (10) Cl.** **21-02**
- (52) **U.S. Cl.**
USPC **D21/765**
- (58) **Field of Classification Search**
USPC D21/419, 421, 423, 426, 760, 765, 766,
D21/769, 771, 776, 803; D12/1; 280/7.14,
280/11.115, 11.19, 11.27, 11.28, 14.21,
280/87.01, 87.021, 87.03, 87.041, 87.042,
280/607, 608, 609, 809; 180/180, 181;
434/247, 253, 258; 362/500, 545, 565
CPC A63C 17/01; A63C 17/011; A63C 17/012;
A63C 17/014; A63C 17/015; A63C 17/02;
A63C 17/26; A63C 5/003; A63B 69/0022;
B60Q 1/326; B62K 3/001
See application file for complete search history.

4,648,610 A	3/1987	Hegy	
D298,448 S	11/1988	Seehaver	
4,997,196 A *	3/1991	Wood	280/87.042
5,067,058 A *	11/1991	Standley	362/459
5,119,277 A *	6/1992	Copley et al.	362/543
5,278,733 A	1/1994	St. Thomas	
5,294,188 A	3/1994	Vancil, Jr.	
5,475,572 A	12/1995	Tseng	
5,552,972 A	9/1996	Rezvani	
5,653,523 A	8/1997	Roberts	
D397,391 S	8/1998	Jirot	
5,806,959 A	9/1998	Adams et al.	
5,957,541 A	9/1999	Seigler	
D421,083 S	2/2000	Chen	
6,175,196 B1	1/2001	Ragner et al.	
D442,660 S	5/2001	Patel	
D444,527 S	7/2001	Patel	
6,398,395 B1	6/2002	Hyun	
6,619,823 B2	9/2003	Dai	
7,048,284 B1 *	5/2006	Seifert	280/79.11
7,048,421 B1	5/2006	Allen-Atkins	
D534,968 S	1/2007	Proch	
D608,851 S *	1/2010	Hillman	D21/765
8,052,293 B2 *	11/2011	Hurwitz	362/84
D682,379 S	5/2013	Fox	
D684,231 S	6/2013	Albert et al.	
D692,079 S	10/2013	Mackay	
8,579,672 B2	11/2013	Beutler	
2002/0024816 A1	2/2002	Ming-Li	
2003/0185019 A1	10/2003	Rogers et al.	
2004/0257831 A1	12/2004	Liao	
2005/0029767 A1 *	2/2005	Chang	280/87.042
2005/0082774 A1	4/2005	Chiu	

* cited by examiner

Primary Examiner — Cynthia M Chin

(74) *Attorney, Agent, or Firm* — Morgan, Lewis & Bockius LLP; Brett A. Lovejoy

(57) **CLAIM**

The ornamental design for a skateboard with transparent wheel having an inner core, as shown and described.

(56) **References Cited**

U.S. PATENT DOCUMENTS

D222,158 S	10/1971	Noches
D261,406 S	10/1981	Corbin
4,363,502 A	12/1982	Bakerman
D268,195 S	3/1983	Kalish

DESCRIPTION

FIG. 1 is a perspective view of a first embodiment of my new design of a skateboard with transparent wheel having an inner core in which the board is transparent; in which some surfaces of the board, the board undercarriage, the wheel surface, and

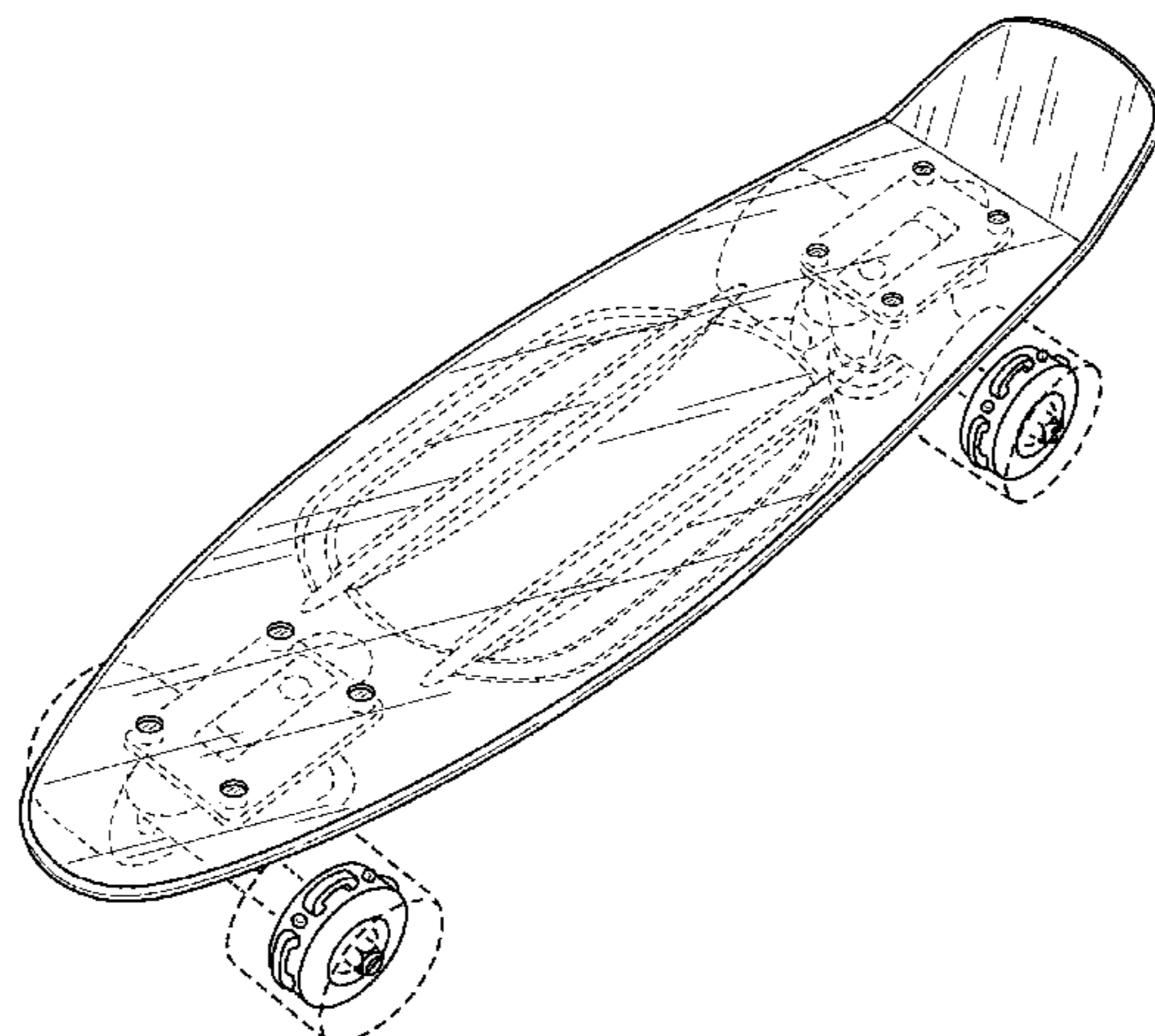

the inner core protrusions are disclaimed and shown in broken lines; and in which the inner core illuminates violet/purple using the USPTO convention of vertical dashed lines for violet/purple;

FIG. 2 is a first side view of the design of FIG. 1;

FIG. 3 is a second side view of the design of FIG. 1;

FIG. 4 is a top view of the design of FIG. 1;

FIG. 5 is a bottom view of the design of FIG. 1;

FIG. 6 is a front view of the design of FIG. 1;

FIG. 7 is a back view of the design of FIG. 1;

FIG. 8 is a perspective view of a second embodiment of the design of FIG. 1, in which the inner core illuminates blue using the USPTO convention of horizontal solid lines for blue;

FIG. 9 is a perspective view of a third embodiment of the design of FIG. 1, in which the inner core illuminates green using the USPTO convention of right diagonal solid lines for green;

FIG. 10 is a perspective view of a fourth embodiment of the design of FIG. 1, in which the inner core illuminates yellow/gold using the USPTO convention of horizontal hashed lines for yellow/gold;

FIG. 11 is a perspective view of a fifth embodiment of the design of FIG. 1, in which the inner core illuminates orange using the USPTO convention of diagonal hashed lines for orange;

FIG. 12 is a perspective view of a sixth embodiment of the design of FIG. 1, in which the inner core illuminates red/pink using the USPTO convention of vertical solid lines for red/pink;

FIG. 13 is a perspective view of a seventh embodiment of the design of FIG. 1, in which the inner core illuminates white light; and,

FIG. 14 is a perspective view of an eighth embodiment of the design of FIG. 1, the perspective view illustrating the skateboard with transparent wheel having an inner core in which the inner core is not illuminating.

Unless otherwise noted, the broken lines in the above described FIGS. 1-14 are for illustrative purposes only and form no part of the claimed design.

1 Claim, 13 Drawing Sheets

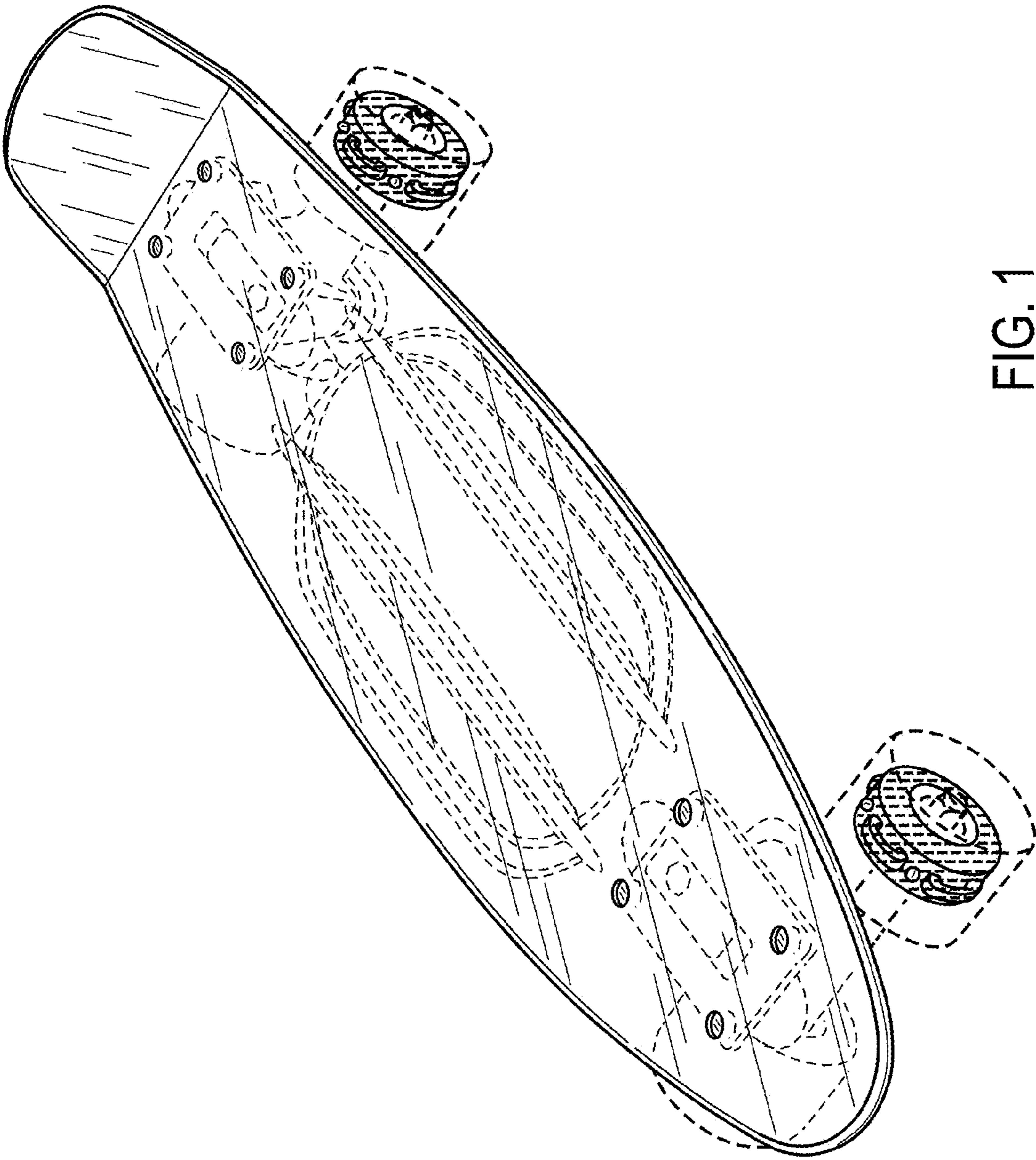

FIG. 1

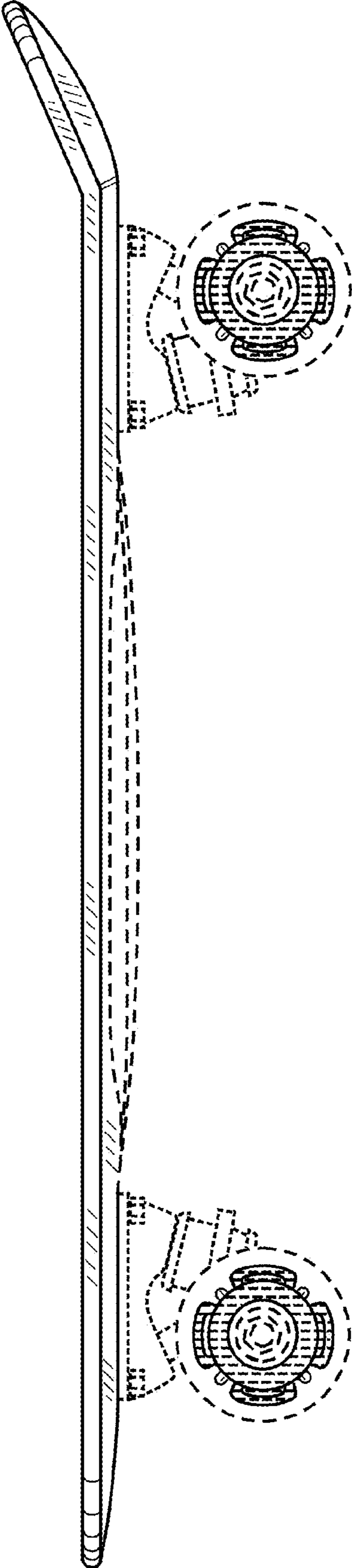

FIG. 2

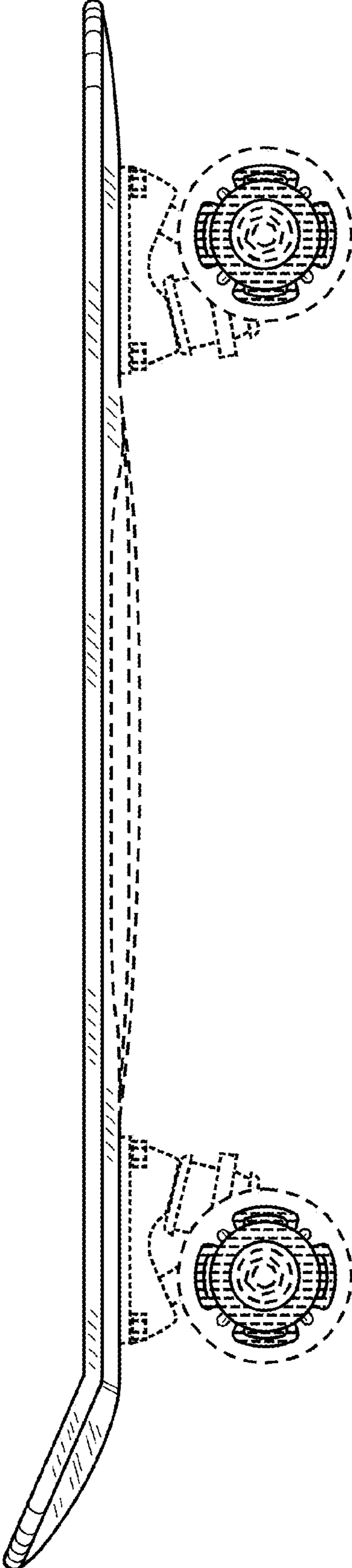

FIG. 3

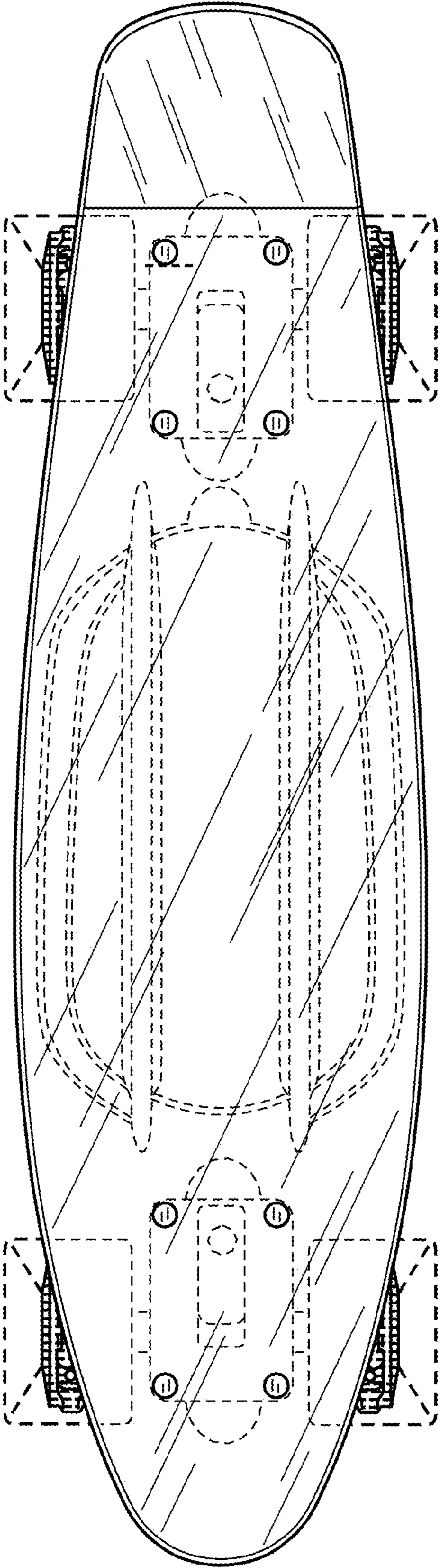

FIG. 4

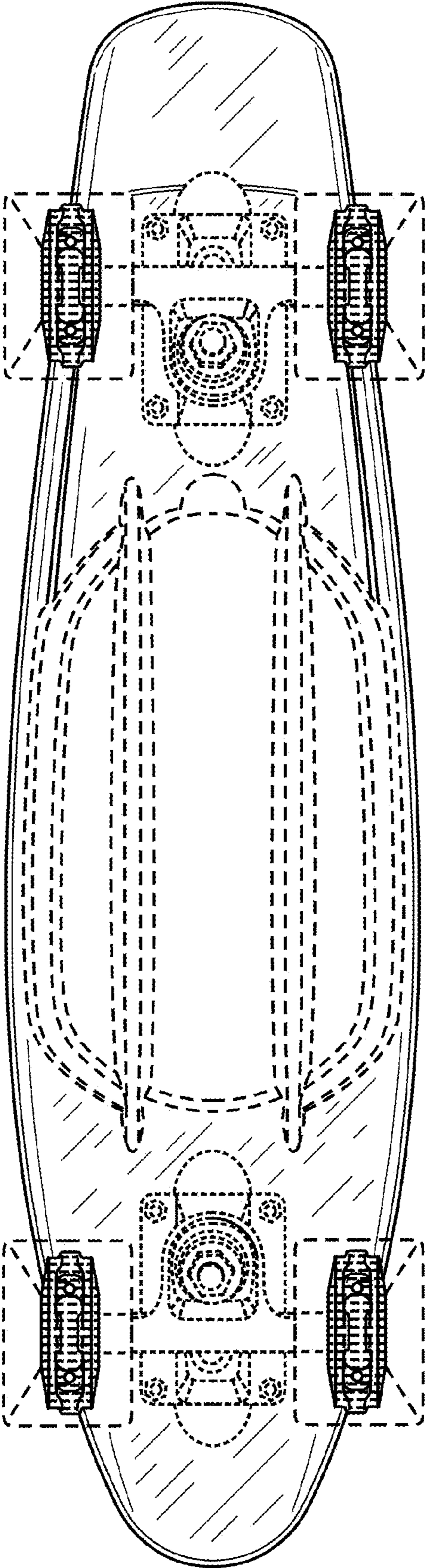

FIG. 5

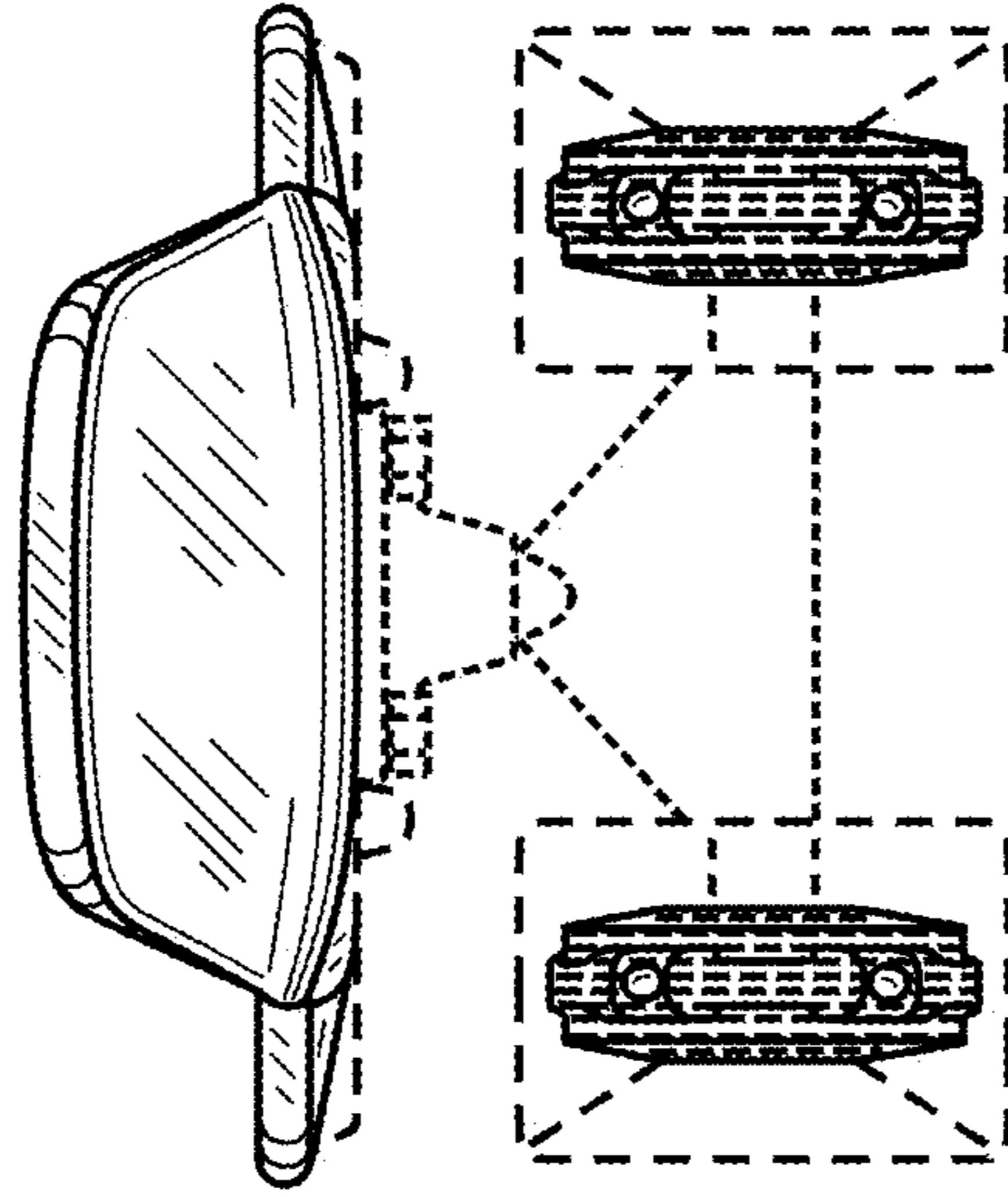

FIG. 6

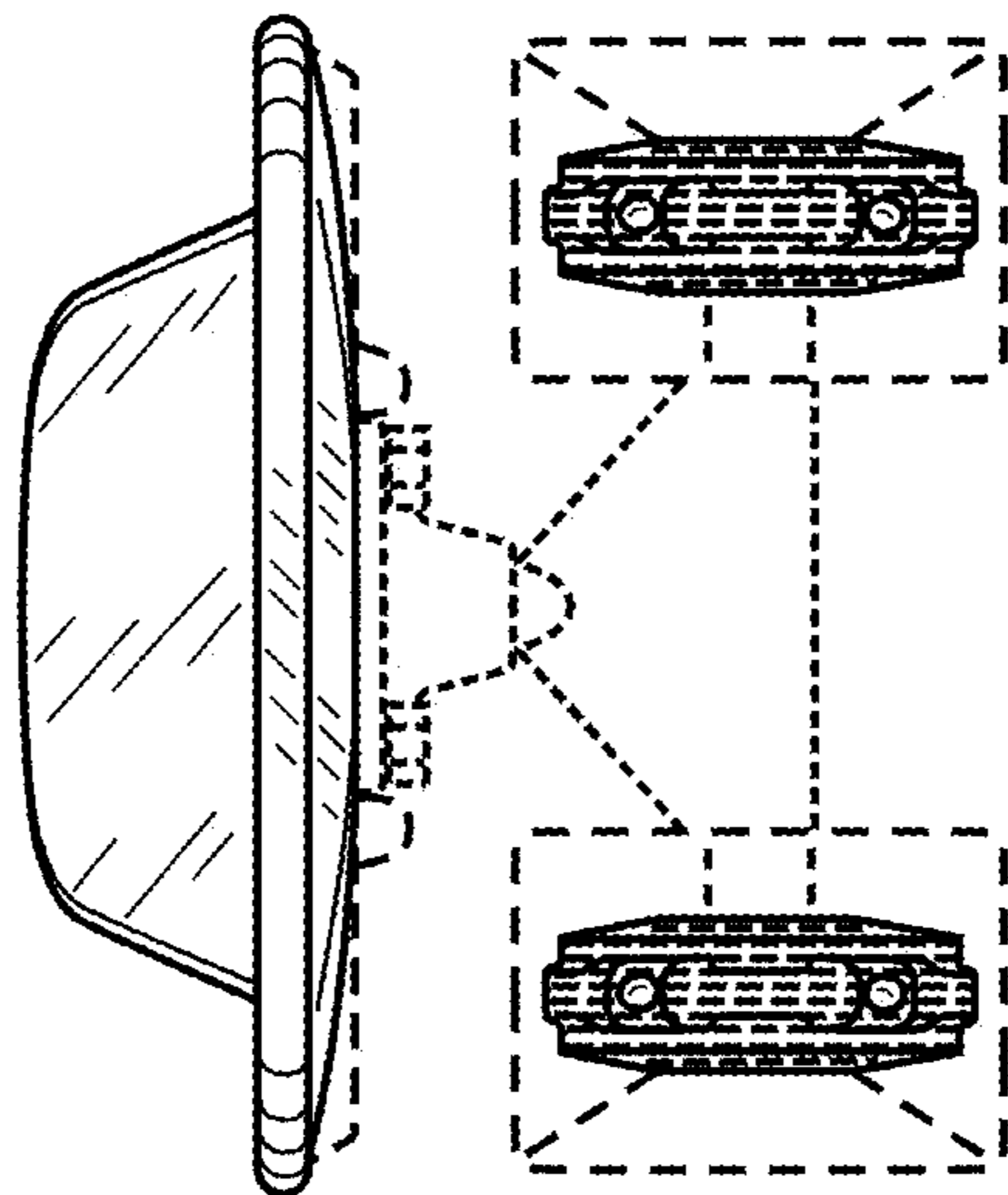

FIG. 7

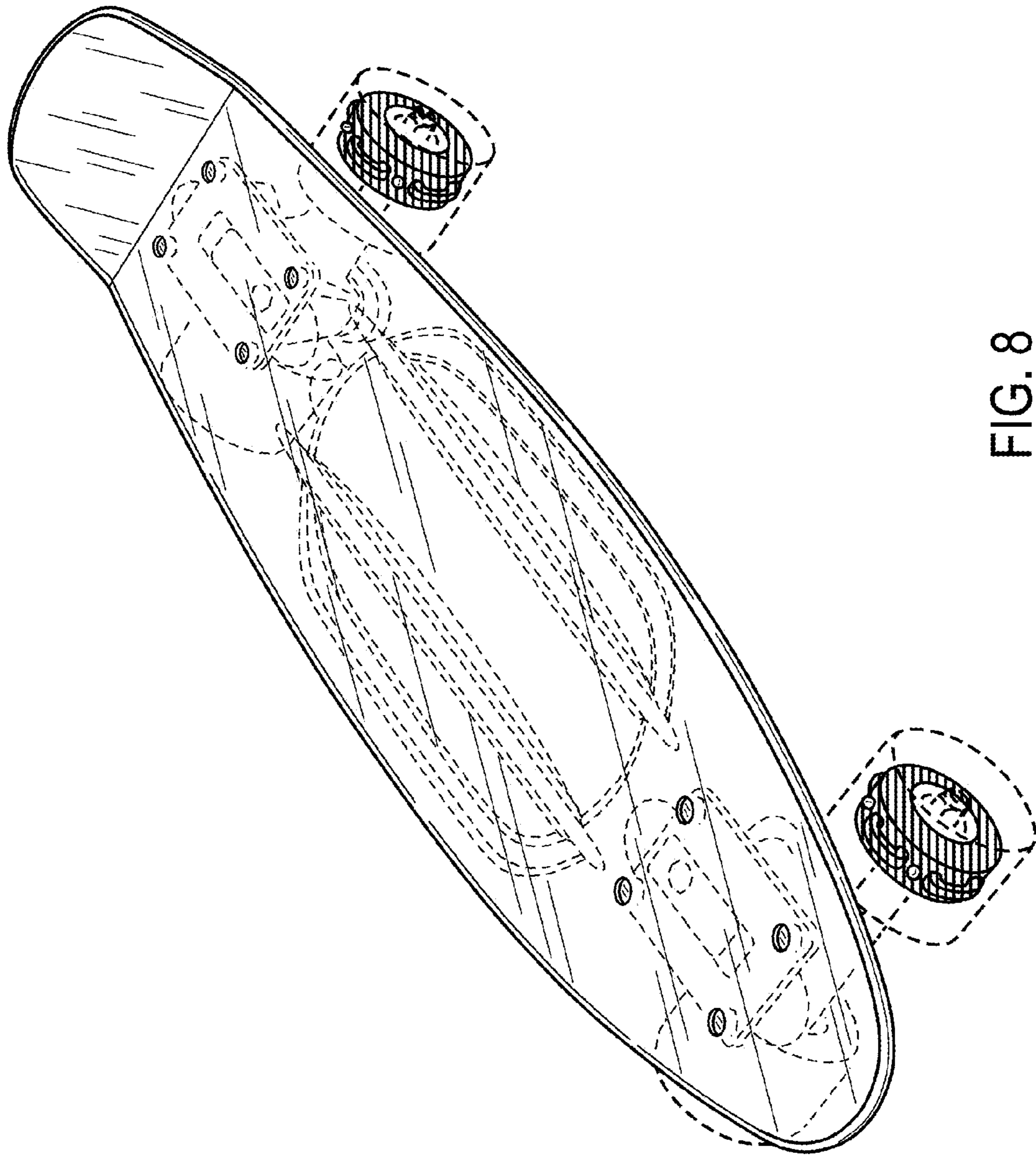

FIG. 8

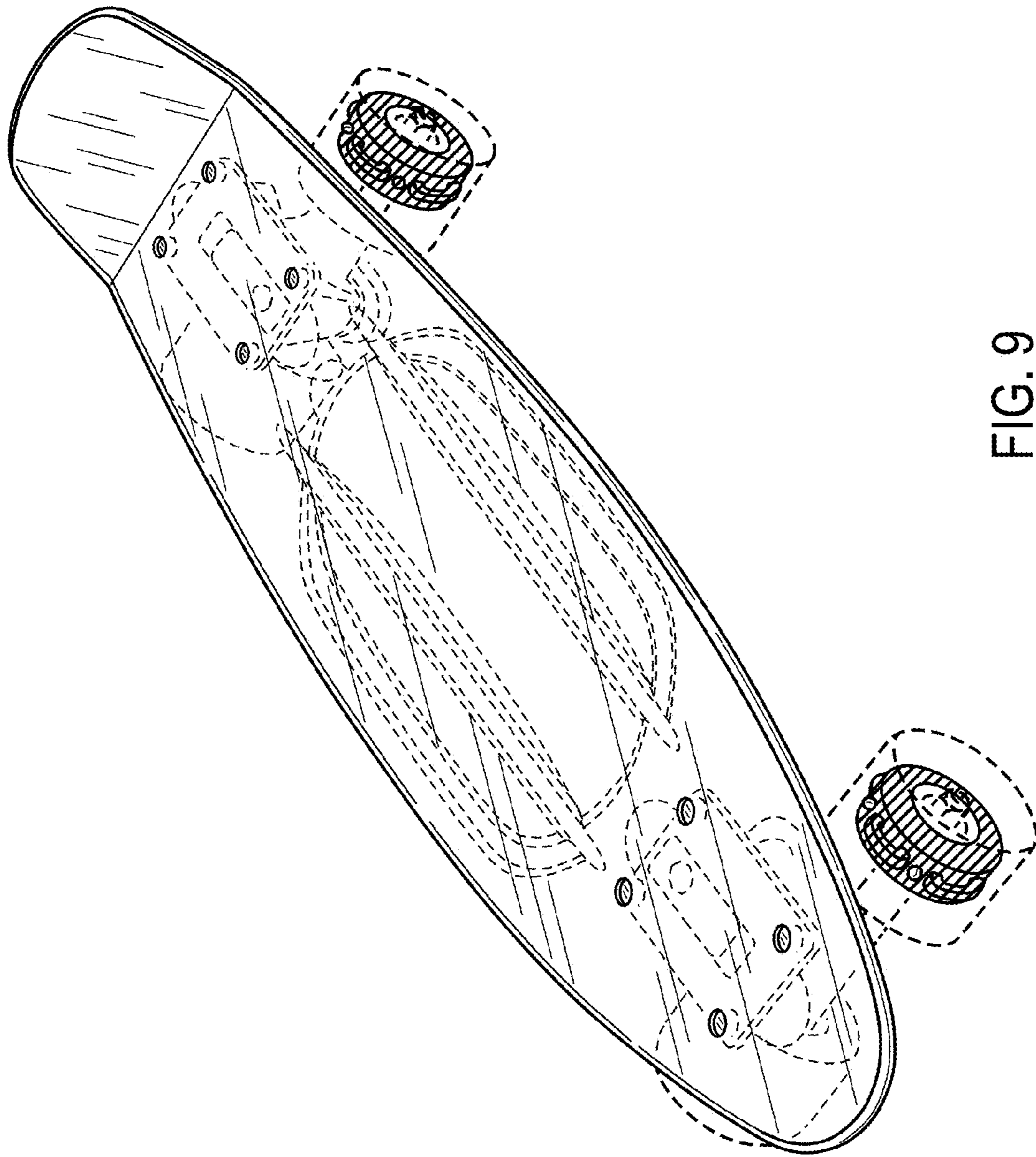

FIG. 9

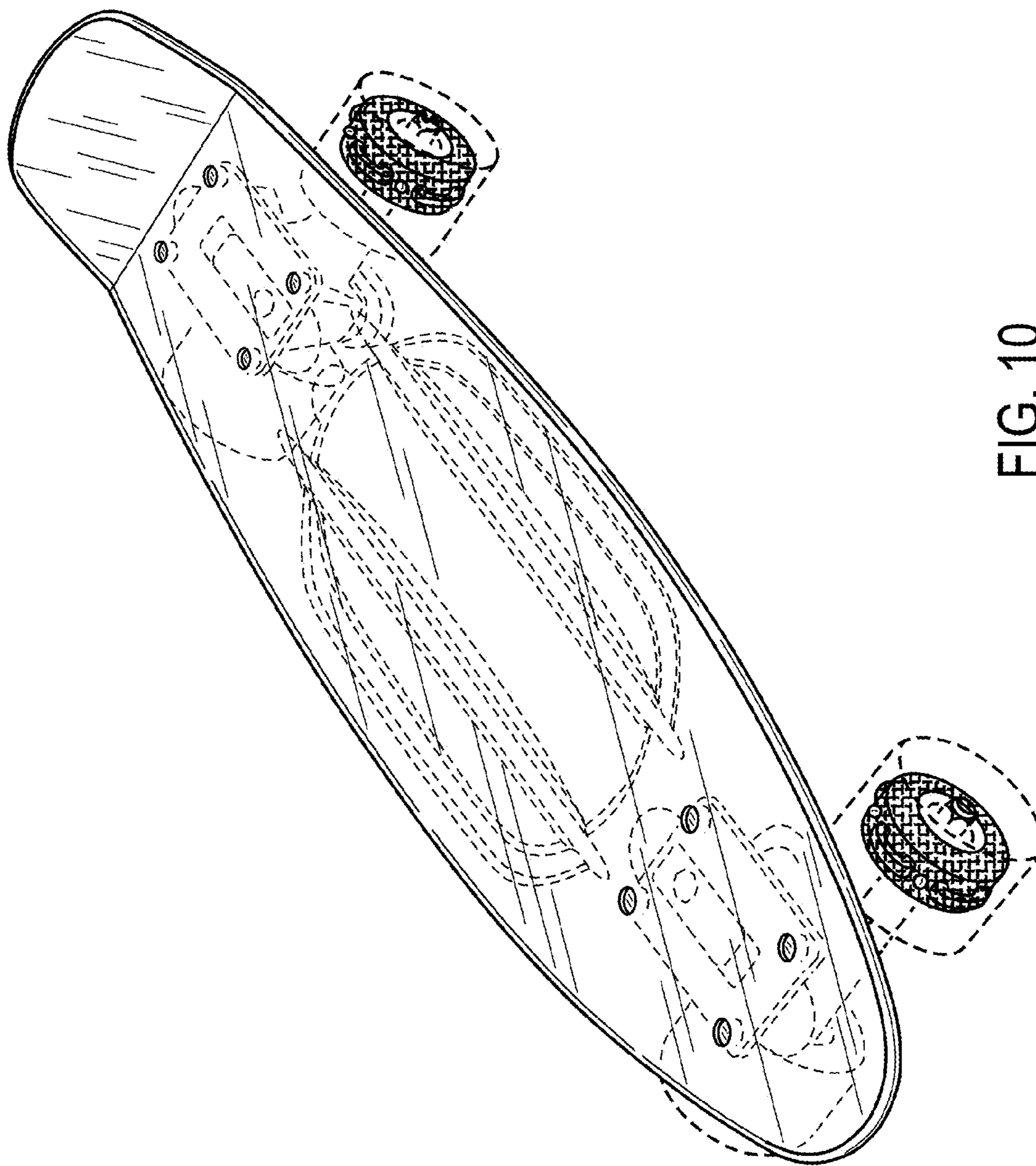

FIG. 10

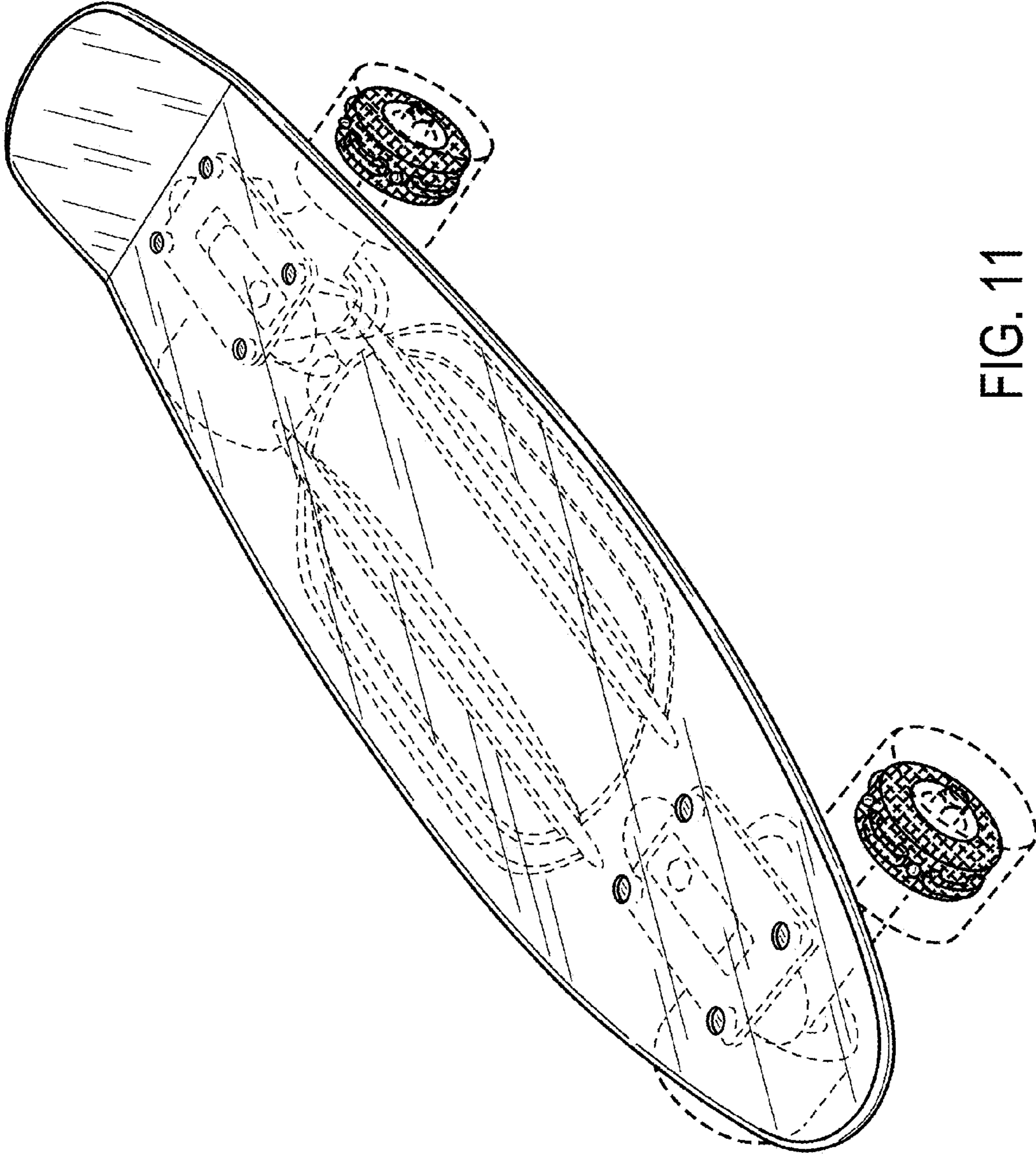

FIG. 11

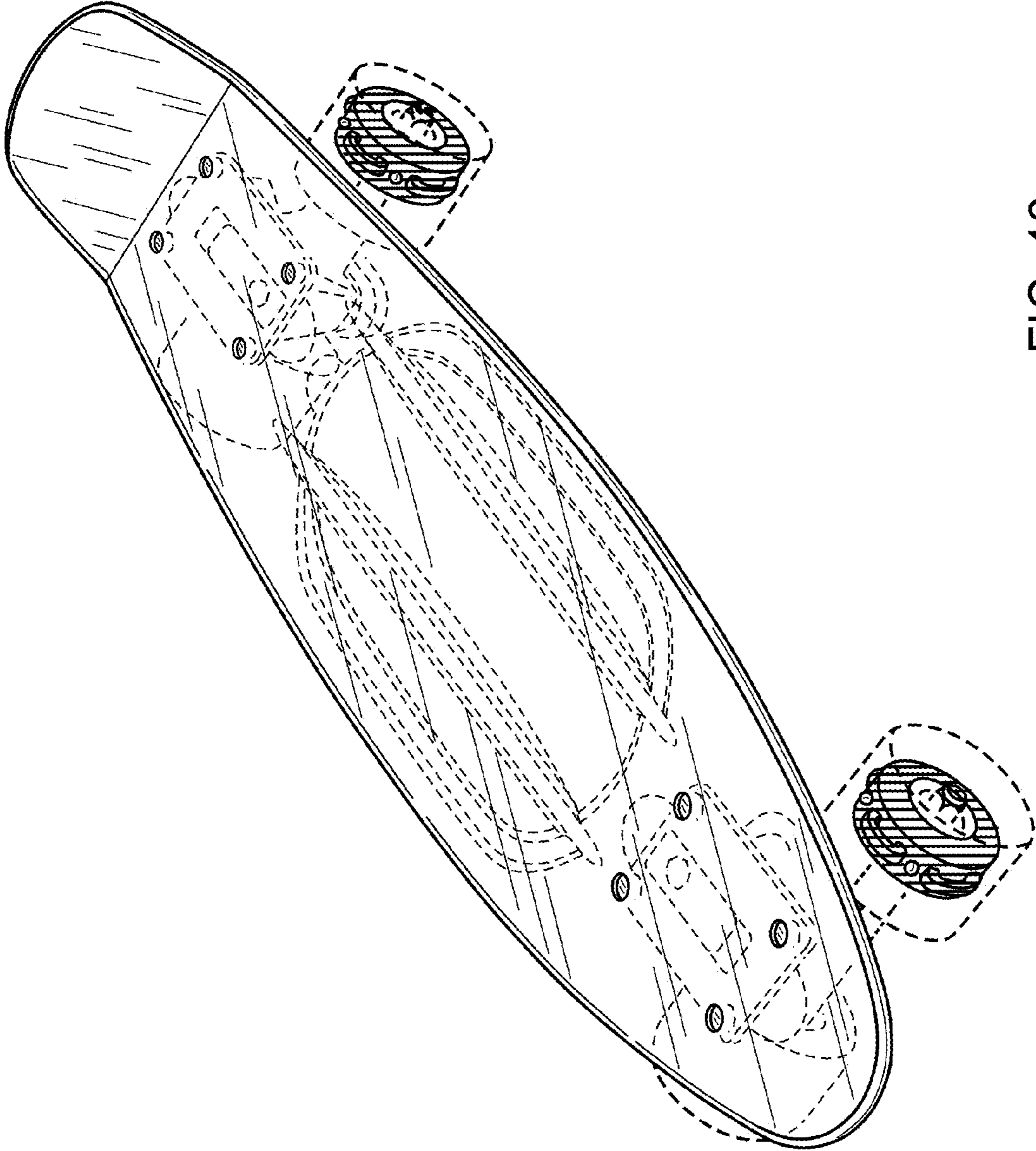

FIG. 12

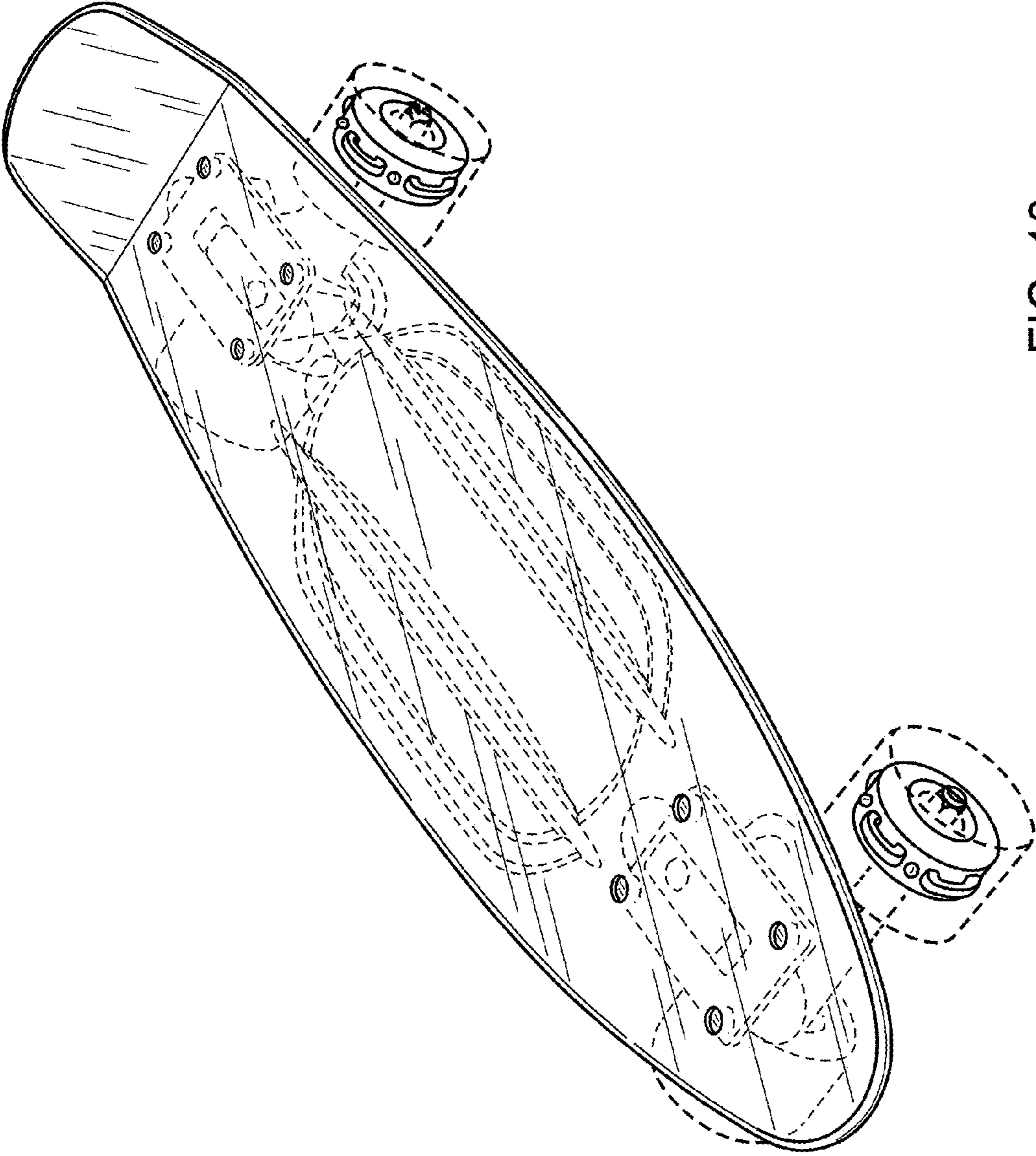

FIG. 13

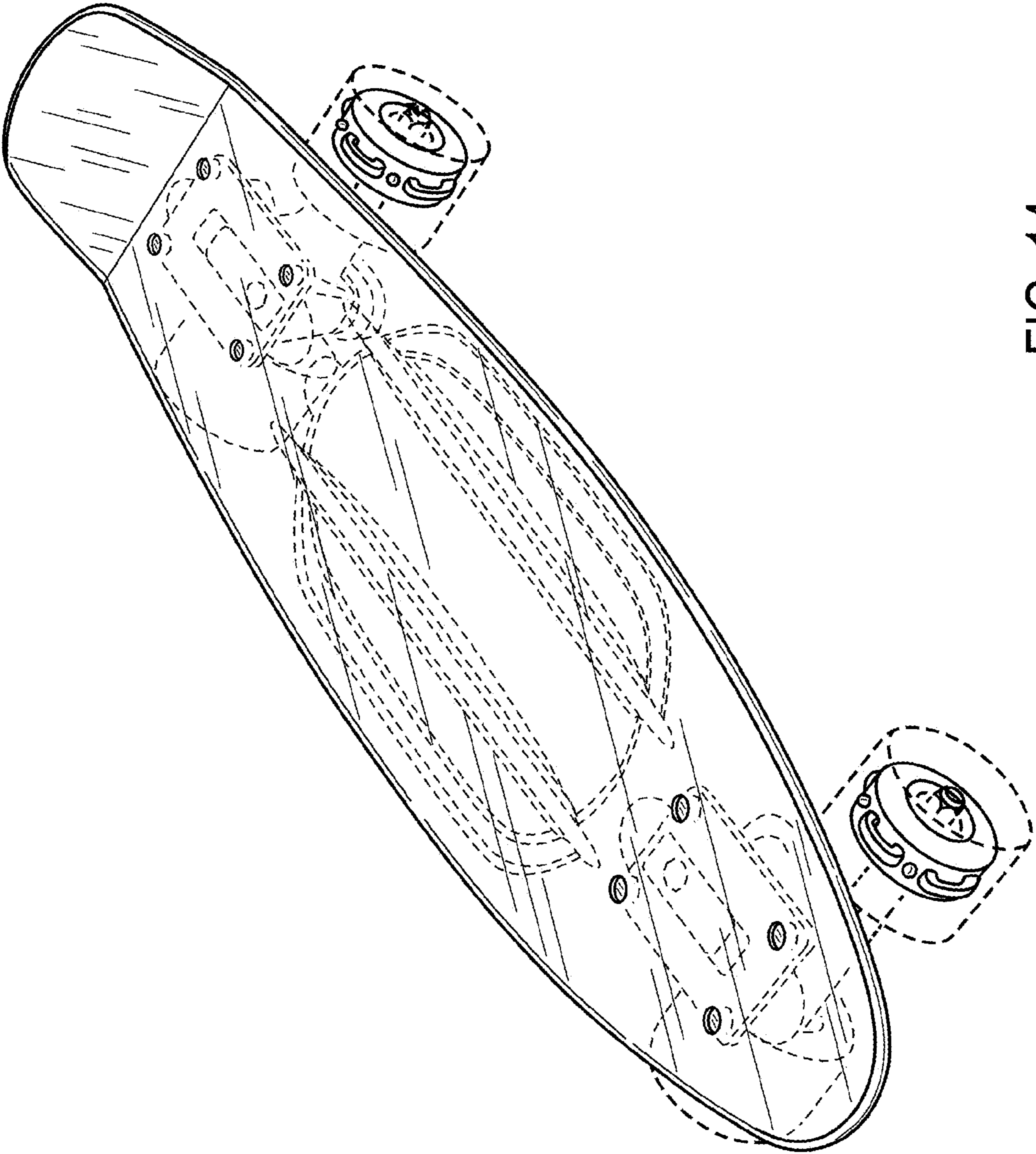

FIG. 14