



US00D733130S

(12) **United States Design Patent**
Kim et al.

(10) **Patent No.:** **US D733,130 S**
(45) **Date of Patent:** **** Jun. 30, 2015**

(54) **ELECTRONIC DEVICE**

(71) Applicant: **Samsung Electronics Co., Ltd.**,
Suwon-Si (KR)

(72) Inventors: **Hyun Jin Kim**, Seoul (KR); **Ji yeon Kwak**, Seoul (KR); **Joon Kyu Seo**, Seoul (KR)

(73) Assignee: **Samsung Electronics Co., Ltd.**,
Suwon-si (KR)

(**) Term: **14 Years**

(21) Appl. No.: **29/465,047**

(22) Filed: **Aug. 23, 2013**

(30) **Foreign Application Priority Data**

Feb. 23, 2013 (KR) 30-2013-0009585

(51) **LOC (10) Cl.** **14-02**

(52) **U.S. Cl.**
USPC **D14/344**

(58) **Field of Classification Search**
USPC D14/341, 342, 343, 344, 345, 346, 347,
D14/420, 426, 427; D10/30, 31, 32, 37, 38,
D10/39, 65; 368/281, 282, 294, 295, 296;
455/100; 361/679.03; 379/433.1;
D11/3

See application file for complete search history.

(56) **References Cited**

U.S. PATENT DOCUMENTS

5,274,613 A * 12/1993 Seager 368/13
D466,487 S * 12/2002 Wada et al. D14/138 R
D556,194 S * 11/2007 Rambosek et al. D14/480.3
D565,427 S * 4/2008 Ellner et al. D10/31

D576,501 S * 9/2008 Tang D10/32
D589,374 S * 3/2009 Tang D10/32
D638,723 S * 5/2011 Ong D10/32
8,301,211 B2 * 10/2012 Lee et al. 455/575.6
D703,069 S * 4/2014 Adams et al. D10/31
D711,002 S * 8/2014 Ohnemus et al. D24/186
D717,261 S * 11/2014 Yun et al. D14/138 R
D721,701 S * 1/2015 Al-Nasser D14/344
2014/0039804 A1 * 2/2014 Park et al. 702/19

* cited by examiner

Primary Examiner — Barbara Fox

Assistant Examiner — Chelsea Sealey

(74) *Attorney, Agent, or Firm* — NSIP Law

(57) **CLAIM**

The ornamental design for an electronic device, as shown and described.

DESCRIPTION

FIG. 1 is a front perspective view of an electronic device showing our new design;

FIG. 2 is a front view thereof;

FIG. 3 is a rear view thereof;

FIG. 4 is a left-side view thereof;

FIG. 5 is a right-side view thereof;

FIG. 6 is a top view thereof;

FIG. 7 is a bottom view thereof;

FIG. 8 is a perspective view of the electronic device of FIG. 1 shown in an open position; and,

FIG. 9 is an enlarged view of the encircled portion A in FIG. 2.

The broken lines indicate portions of the electronic device that form no part of the claimed design.

The dot-dash broken lines encircling portions of the claimed design that are illustrated in enlargements form no part of the claimed design.

1 Claim, 9 Drawing Sheets

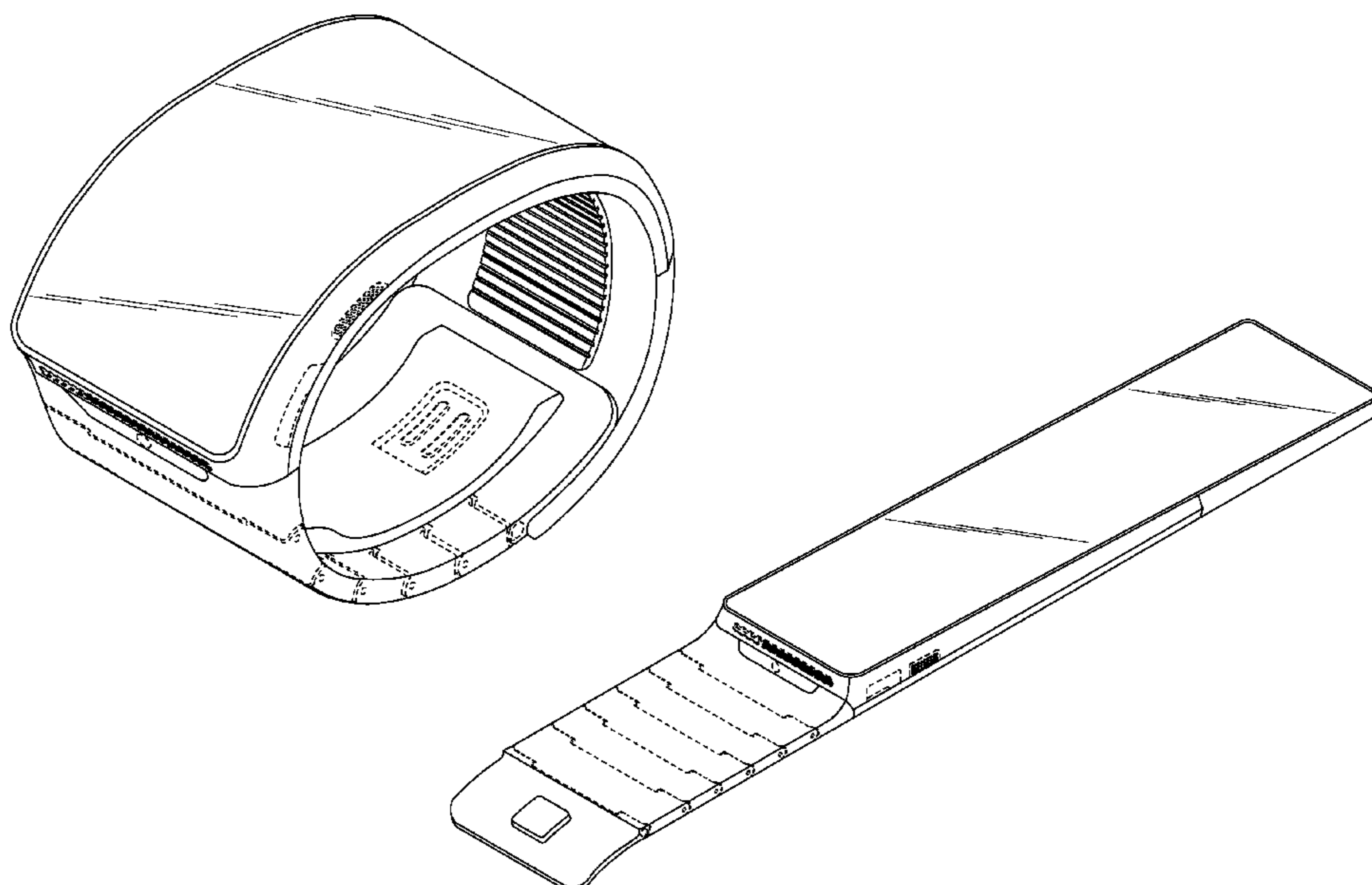

FIG. 1

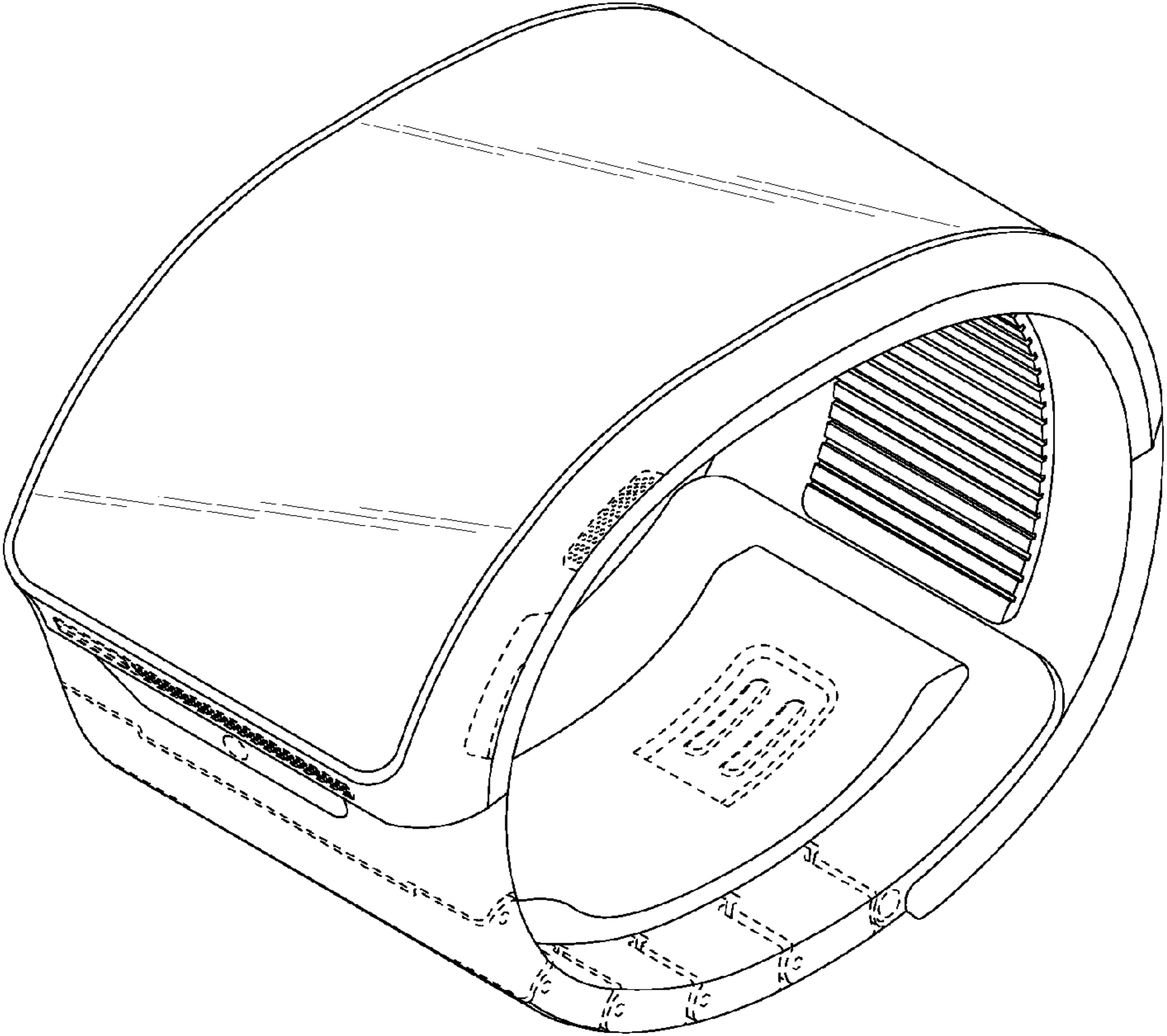

FIG. 2

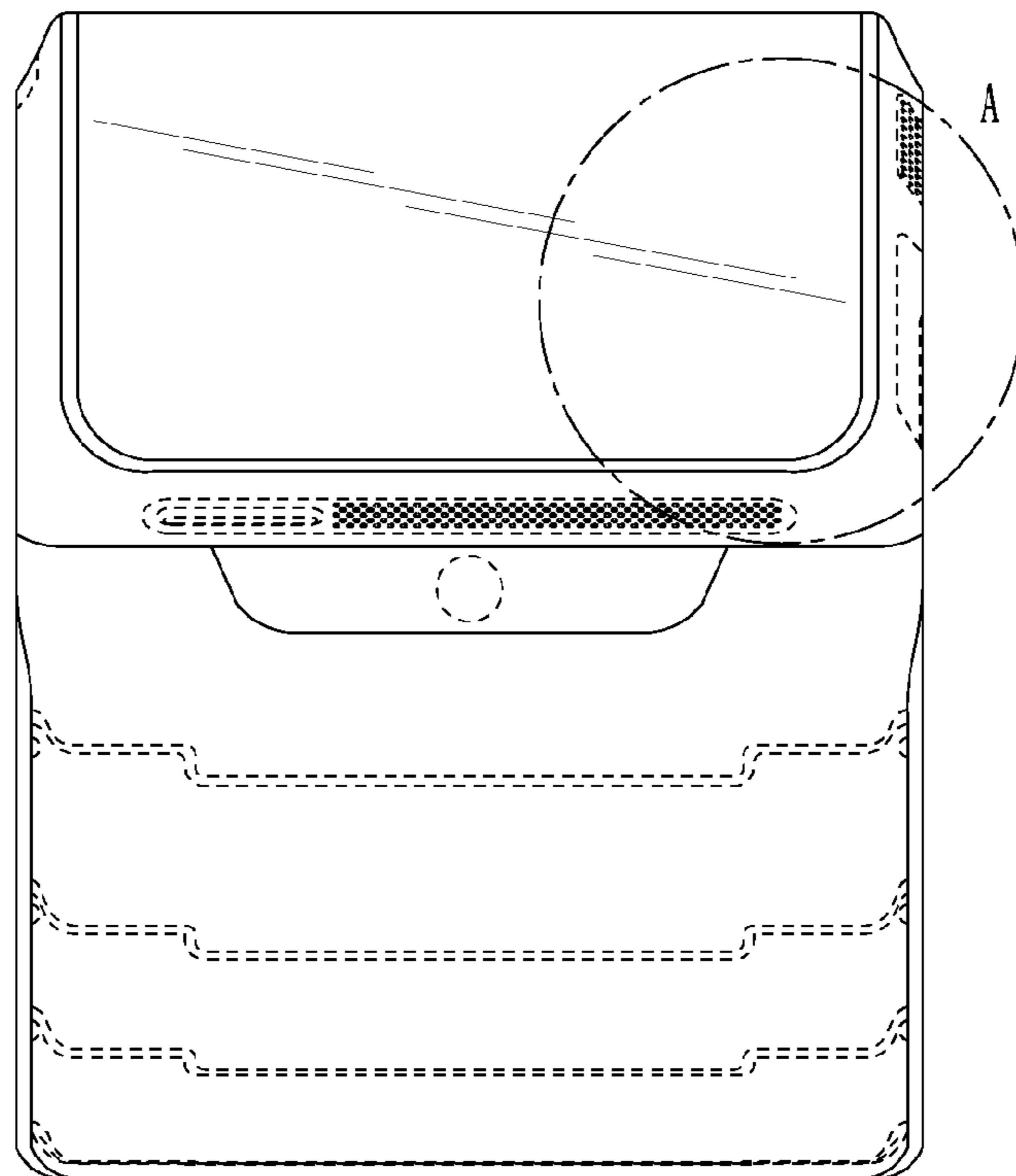

FIG. 3

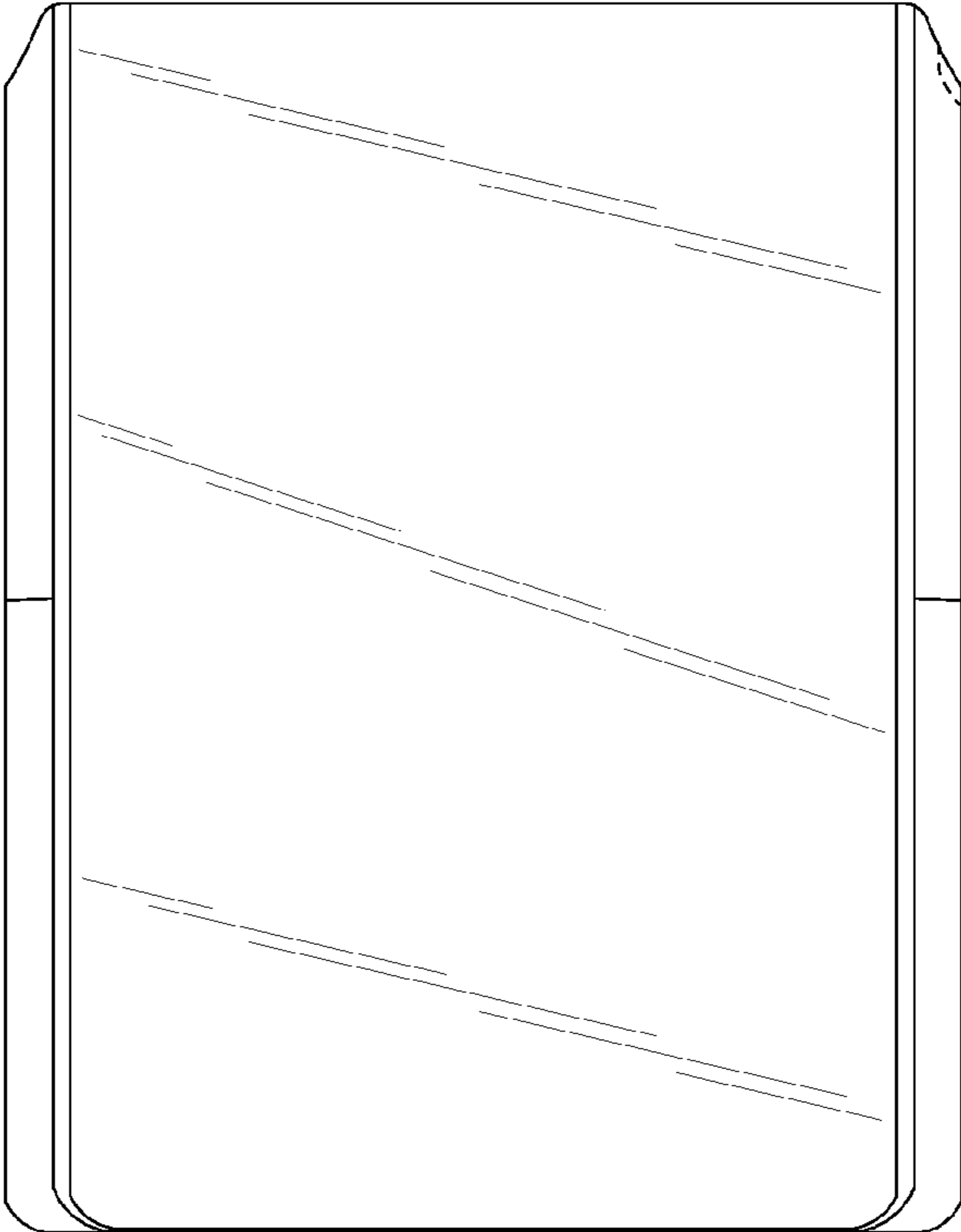

FIG. 4

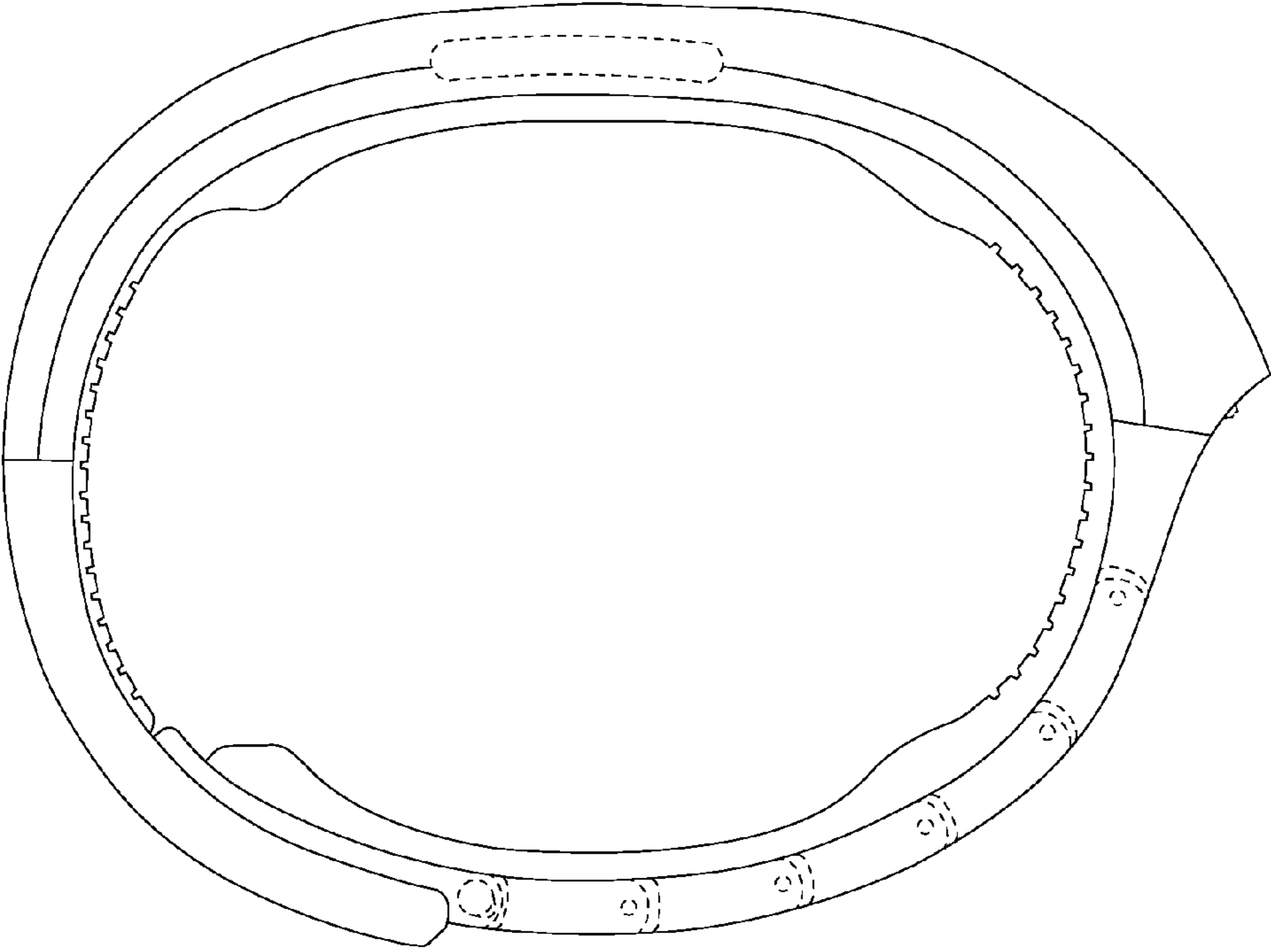

FIG. 5

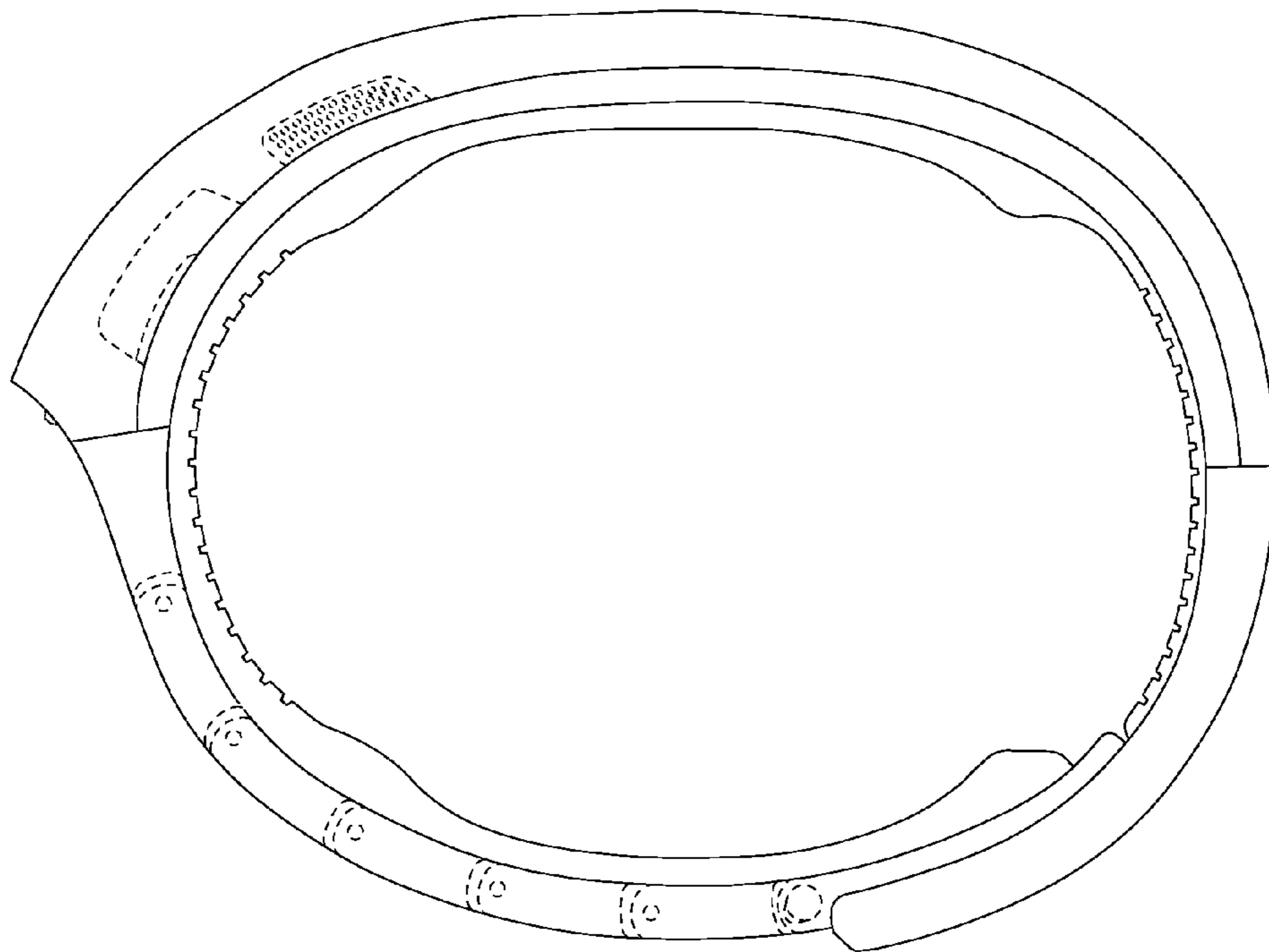

FIG. 6

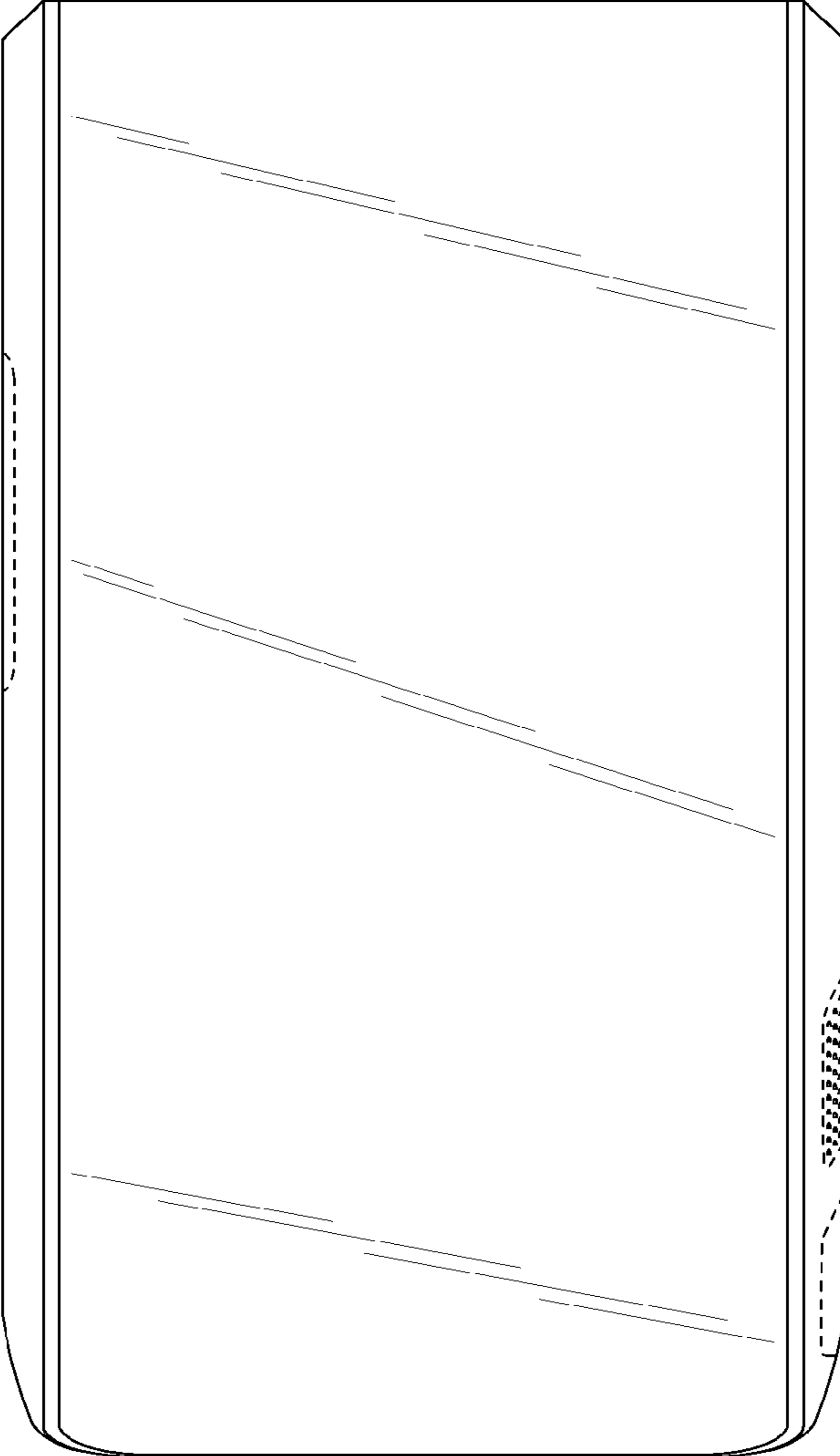

FIG. 7

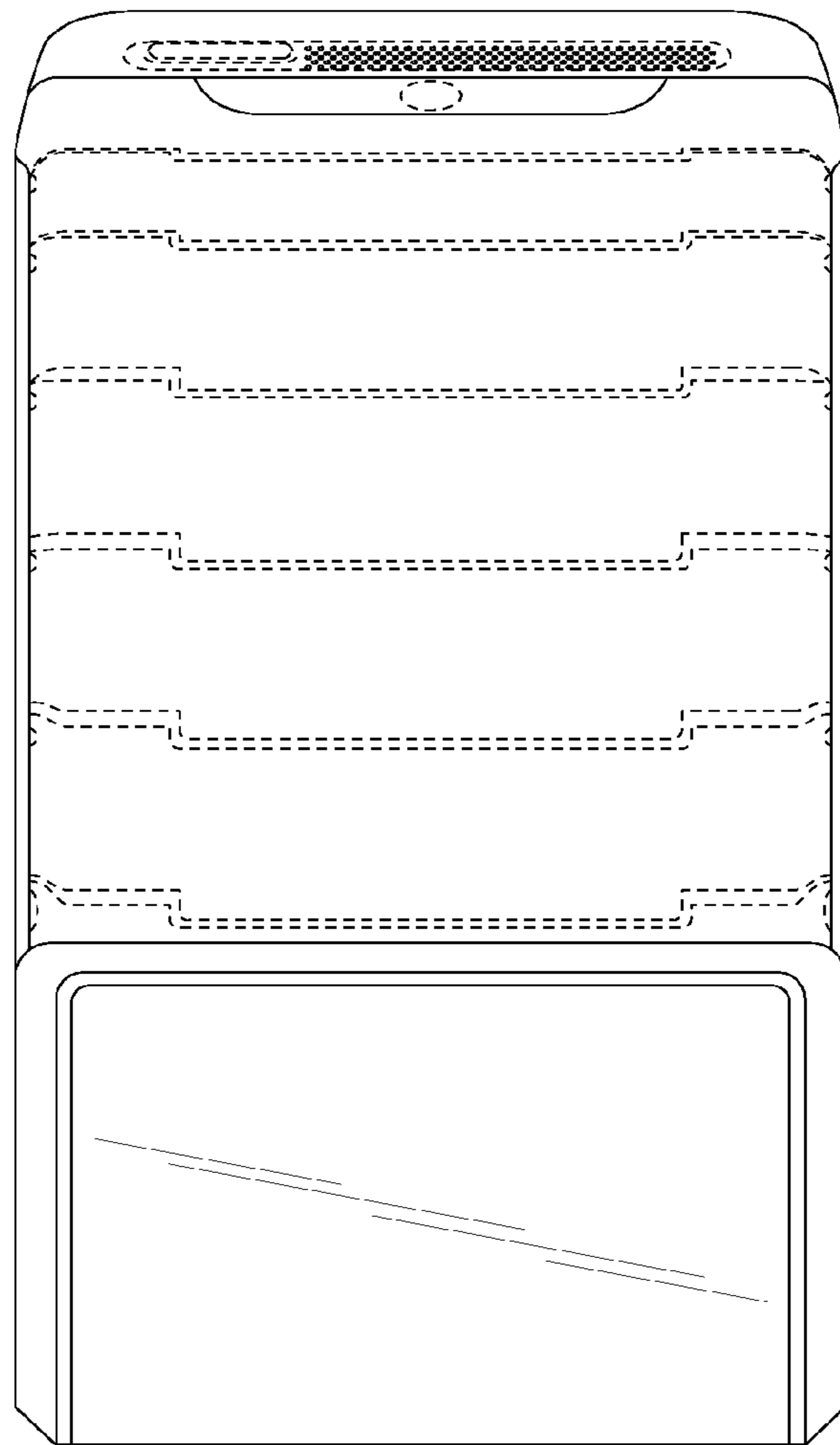

FIG. 8

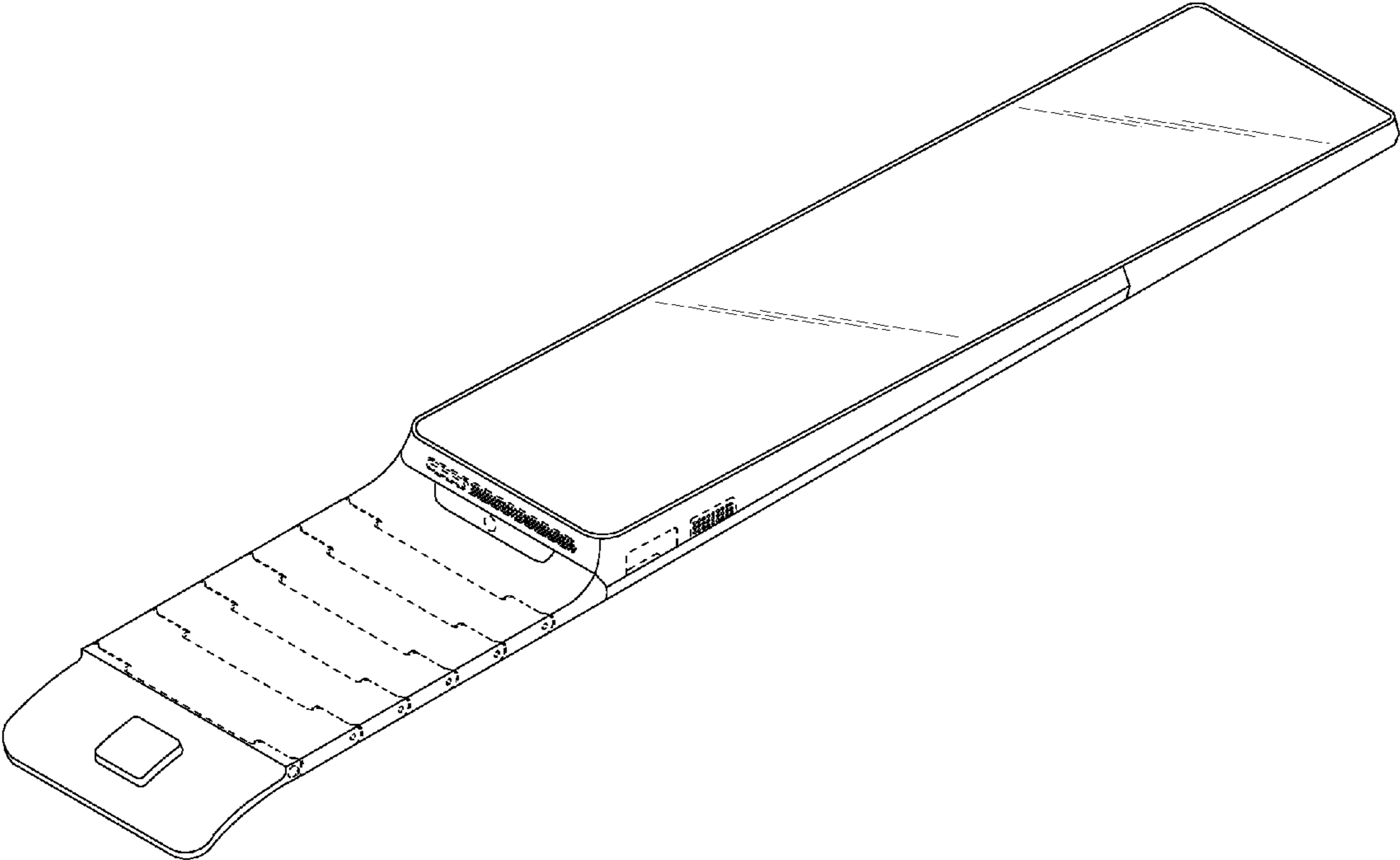

FIG. 9

