



US00D733124S

(12) **United States Design Patent**
Sung et al.

(10) **Patent No.:** **US D733,124 S**
(45) **Date of Patent:** **** Jun. 30, 2015**

(54) **TABLET COMPUTER**

(71) Applicant: **Samsung Electronics Co., Ltd.**,
Suwon-si (KR)
(72) Inventors: **Whan Oh Sung**, Seoul (KR); **Jooyeon Lee**, Gunposi (KR); **Kyu Eun Hwang**, Seoul (KR); **Youngkeun Lee**, Seoul (KR); **Jochen Backs**, San Francisco, CA (US)
(73) Assignee: **Samsung Electronics Co., Ltd.**,
Suwon-Si (KR)

(**) Term: **14 Years**

(21) Appl. No.: **29/459,304**

(22) Filed: **Jun. 28, 2013**

(30) **Foreign Application Priority Data**

Jan. 3, 2013 (KR) 30-2013-0000374

(51) **LOC (10) Cl.** **14-02**

(52) **U.S. Cl.**
USPC **D14/341**

(58) **Field of Classification Search**
USPC D14/341-347, 137, 138 R, 138 AA, D14/138 C, 138 G, 496, 203.1, 203.3, 203.4, D14/203.7, 129, 130, 147, 248, 250, 374, D14/385, 388, 389, 315-318, 439, 126, 336, D14/339, 340; D10/104.1; D21/329; 455/556.1, 556.2, 566, 575.1, 90.3; 379/433.04, 433.01; 345/173, 901, 345/905; 361/679.26, 679.27, 679.3, 361/679.55, 679.56, 680-686; D6/308, D6/310; 463/37; 248/917-924
CPC A63H 33/3016; G06F 1/1613; H04M 1/0202; H04M 1/0279; H04M 1/0281; H04M 1/0283

See application file for complete search history.

(56) **References Cited**

U.S. PATENT DOCUMENTS

D572,743	S	*	7/2008	Madonna et al.	D14/126
D607,854	S	*	1/2010	Sagawa	D14/126
D663,281	S	*	7/2012	Hwang	D14/138 G
D671,514	S	*	11/2012	Kim et al.	D14/138 G
D671,940	S	*	12/2012	Kim	D14/374
D677,660	S	*	3/2013	Groene et al.	D14/341
D687,820	S	*	8/2013	Kim	D14/341
D691,104	S	*	10/2013	Park	D14/138 G
D696,246	S	*	12/2013	Kim	D14/341
D701,847	S	*	4/2014	Choi	D14/138 G
D702,231	S	*	4/2014	Park et al.	D14/341
D702,232	S	*	4/2014	Choi	D14/341
D705,219	S	*	5/2014	Martin et al.	D14/315
D705,776	S	*	5/2014	Groene et al.	D14/341
D706,252	S	*	6/2014	Kim et al.	D14/248
D706,773	S	*	6/2014	Lu	D14/341
D712,400	S	*	9/2014	Kim et al.	D14/341
D713,403	S	*	9/2014	Groene et al.	D14/341
D716,799	S	*	11/2014	Green et al.	D14/341
D719,158	S	*	12/2014	Akana et al.	D14/374

* cited by examiner

Primary Examiner — Barbara Fox

Assistant Examiner — Dana K Weiland

(74) *Attorney, Agent, or Firm* — Ladas & parry LLP

(57) **CLAIM**

The ornamental design for a tablet computer, as shown and described.

DESCRIPTION

FIG. 1 is a front/right-side/top perspective view of a tablet computer showing our new design;
FIG. 2 is a front elevational view thereof;
FIG. 3 is a rear elevational view thereof;
FIG. 4 is a left-side elevational view thereof;
FIG. 5 is a right-side elevational view thereof;
FIG. 6 is a top plan view thereof;
FIG. 7 is a bottom plan view thereof; and,
FIG. 8 is a rear/left-side/top perspective view thereof.
The broken lines shown in the drawings represent portions of the tablet computer that form no part of the claimed design.

1 Claim, 7 Drawing Sheets

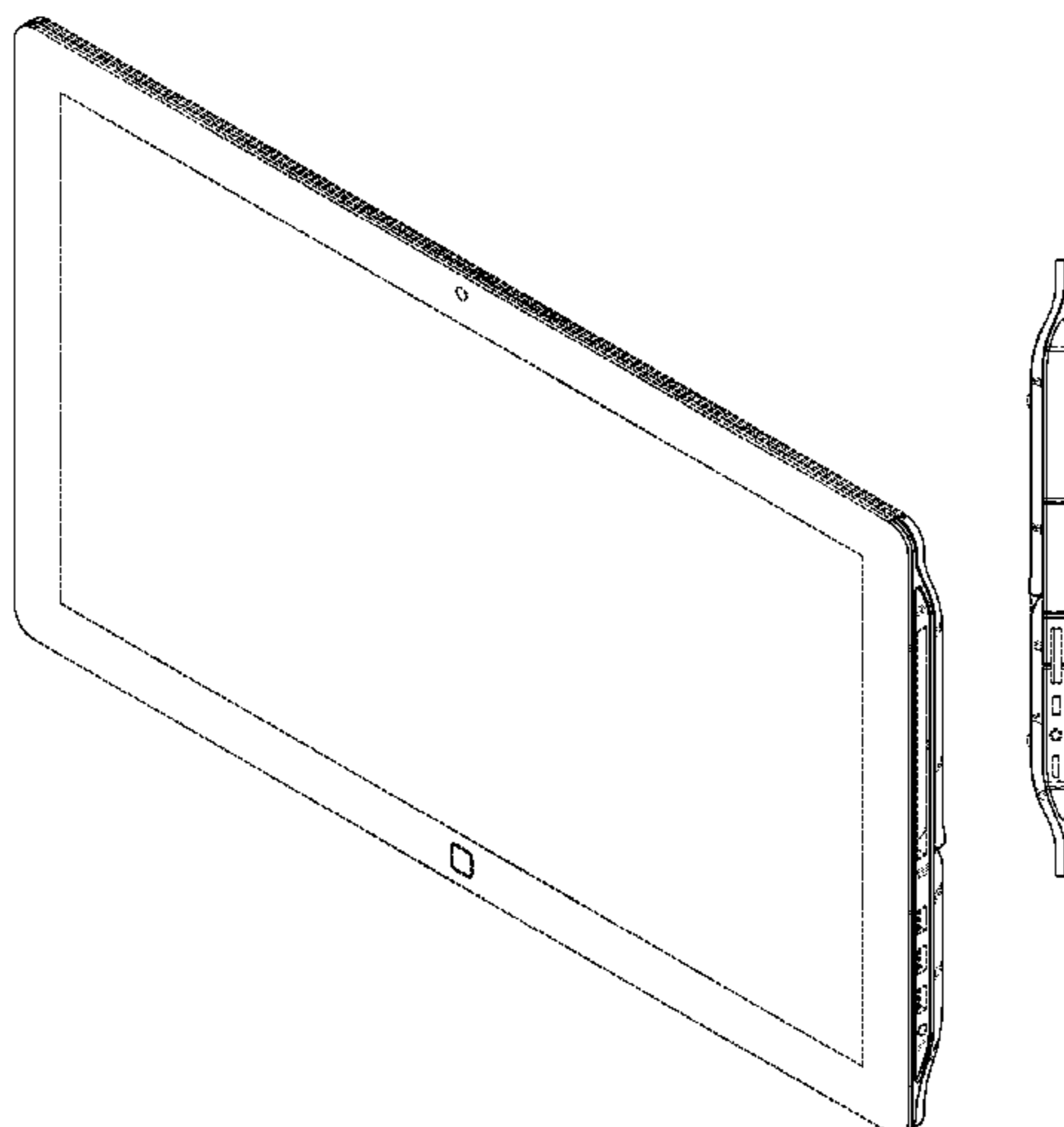

FIG. 1

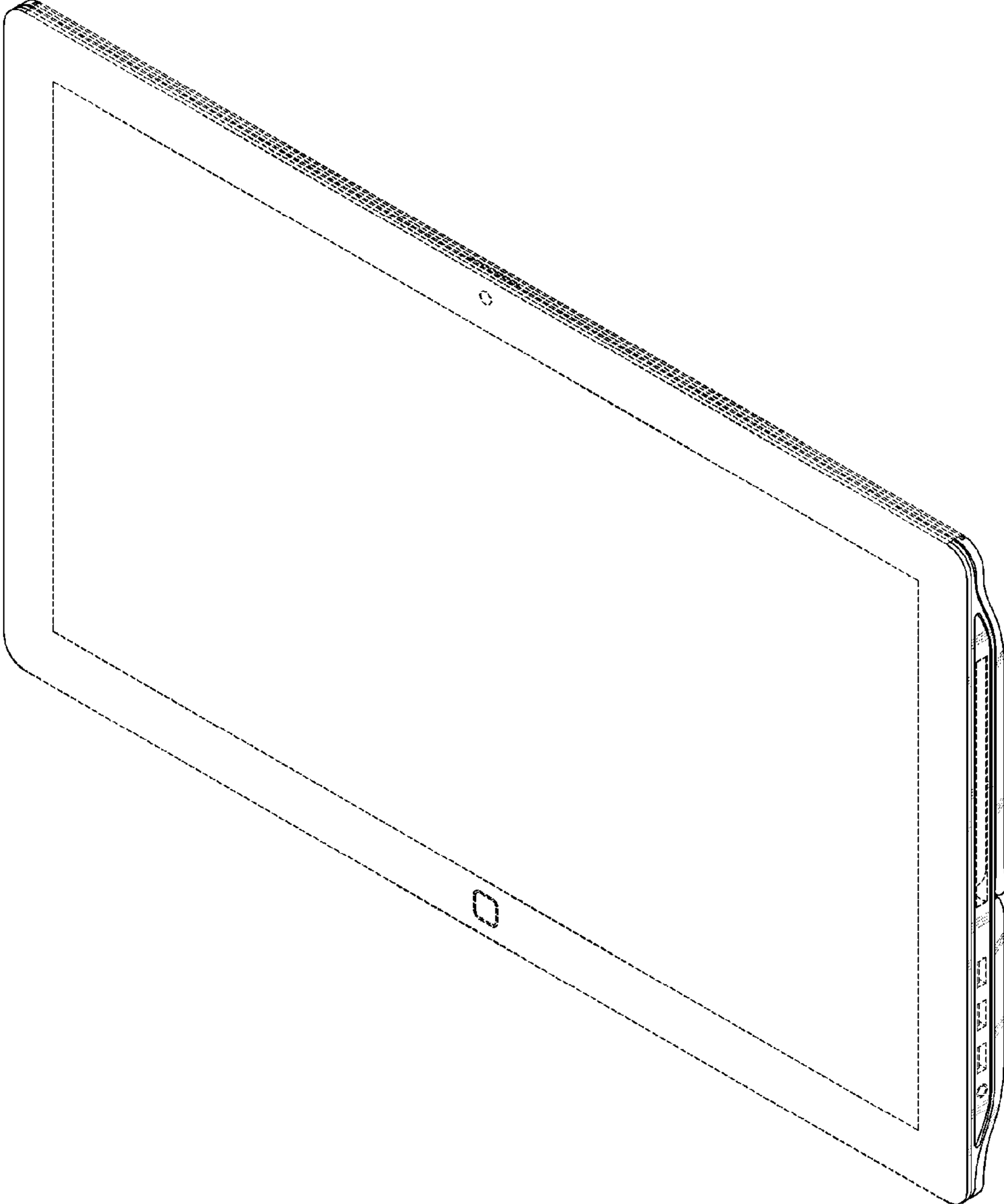

FIG. 2

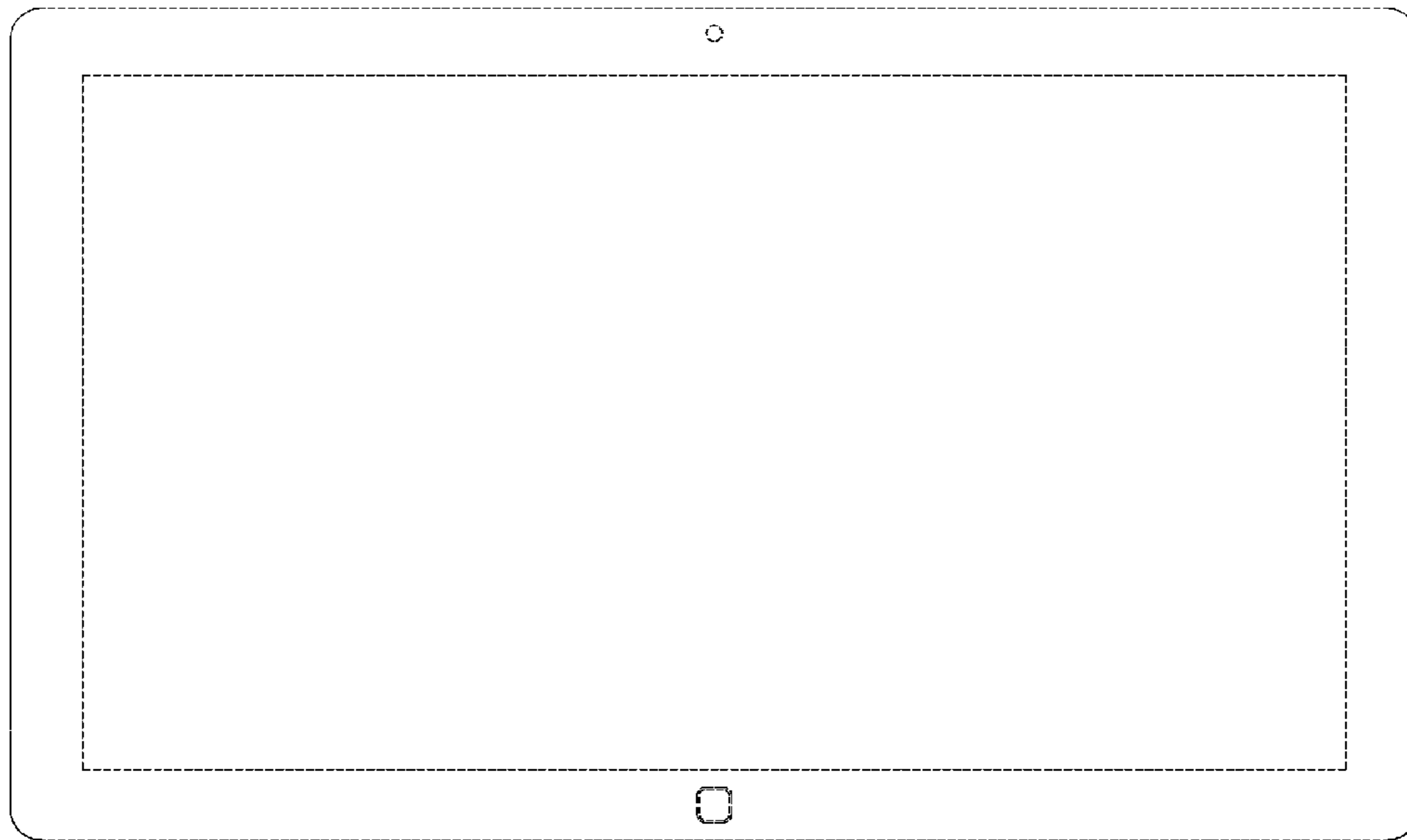

FIG. 3

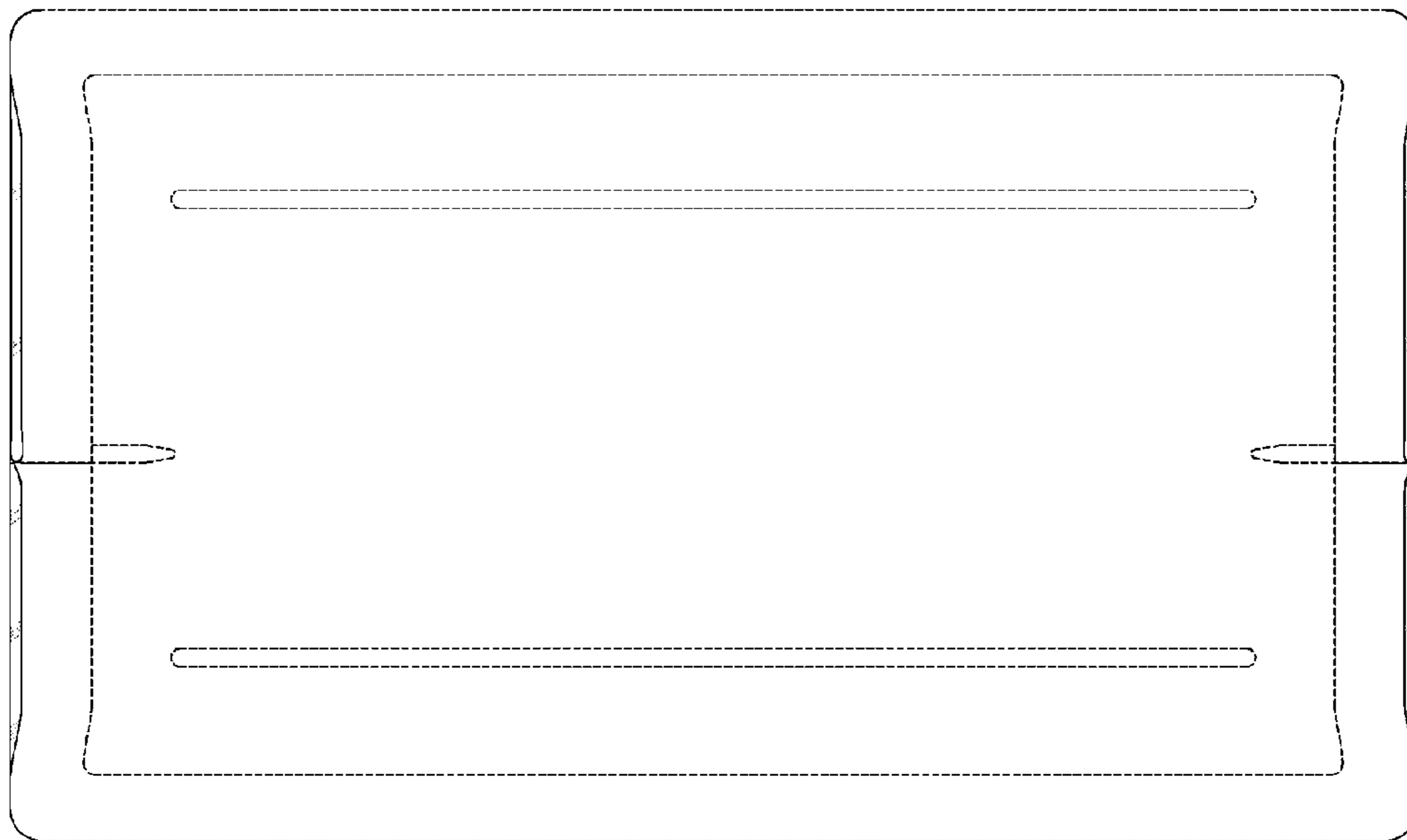

FIG. 4

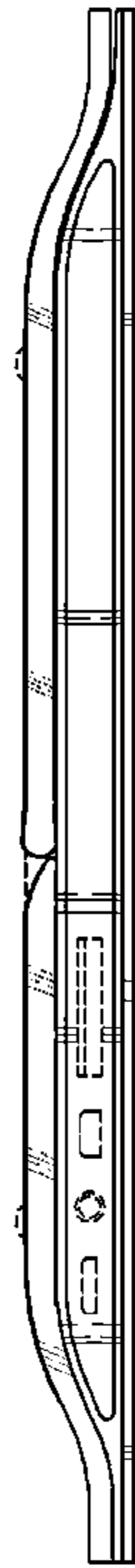

FIG. 5



FIG. 6

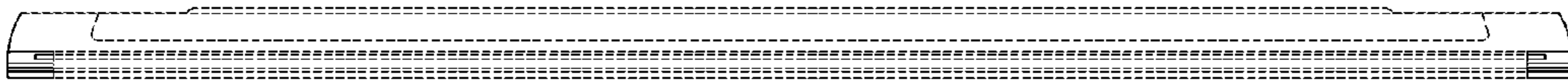

FIG. 7

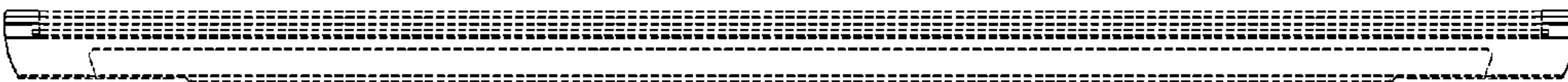

FIG. 8

