



US00D733123S

(12) **United States Design Patent**
Chang

(10) **Patent No.:** **US D733,123 S**
(45) **Date of Patent:** **** Jun. 30, 2015**

(54) **PORTABLE ELECTRONIC DEVICE**

(75) Inventor: **Hoon Suk Chang**, Yongin-si (KR)

(73) Assignee: **Samsung Electronics Co., Ltd.**,
Gyeonggi-do (KR)

(**) Term: **14 Years**

(21) Appl. No.: **29/430,391**

(22) Filed: **Aug. 24, 2012**

(30) **Foreign Application Priority Data**

Feb. 24, 2012 (KR) 30-2012-0008912

(51) **LOC (10) Cl.** **04-02**

(52) **U.S. Cl.**
USPC **D14/341**

(58) **Field of Classification Search**
USPC D14/341-347, 137, 138 R, 138 AA,
D14/138 C, 138 G, 496, 203.1, 203.3, 203.4,
D14/203.7, 129, 130, 147, 218, 248, 389,
D14/388, 426, 420; D10/65, 104.1;
D18/6-7; D21/324, 329, 330;
455/556.1, 556.2, 566, 575.1, 90.3;
379/433.04, 433.01, 433.06, 916;
345/173, 901, 905; 361/679.26, 679.3,
361/679.55, 679.56
CPC ... H04M 1/00; H04M 11/066; H04M 1/2478;
H04M 1/72519; H04M 2201/38; H04M
2250/22

See application file for complete search history.

(56) **References Cited**

U.S. PATENT DOCUMENTS

D337,569 S 7/1993 Kando
D558,757 S 1/2008 Andre et al.
D558,758 S 1/2008 Andre et al.
D593,087 S * 5/2009 Andre et al. D14/341
D601,538 S * 10/2009 Hong D14/138 G
D601,539 S * 10/2009 Hong D14/138 G

D602,014 S * 10/2009 Andre et al. D14/341
D602,486 S * 10/2009 Andre et al. D14/341
D603,830 S * 11/2009 Webb et al. D14/138 G
D604,297 S * 11/2009 Andre et al. D14/341
D613,735 S * 4/2010 Andre et al. D14/341
D615,083 S * 5/2010 Andre et al. D14/341
D615,088 S * 5/2010 Matsuoka D14/439
D618,677 S 6/2010 Andre et al.
D618,678 S 6/2010 Andre et al.

(Continued)

FOREIGN PATENT DOCUMENTS

EP 2 381 349 A1 10/2011
EP 2 527 968 A1 11/2012

OTHER PUBLICATIONS

U.S. Appl. No. 29/437,148, filed Nov. 14, 2012, JaeWoong Chung.
(Continued)

Primary Examiner — Barbara Fox
(74) *Attorney, Agent, or Firm* — Harness, Dickey & Pierce,
P.L.C.

(57) **CLAIM**
I claim the ornamental design for a portable electronic device,
as shown.

DESCRIPTION

FIG. 1 is a front/right-side/top perspective view of a portable electronic device showing our new design;
FIG. 2 is a front-side elevational view thereof;
FIG. 3 is a rear-side elevational view thereof;
FIG. 4 is a left-side elevational view thereof;
FIG. 5 is a right-side elevational view thereof;
FIG. 6 is a top-side elevational view thereof; and,
FIG. 7 is a bottom-side elevational view thereof.
The dashed broken lines in the drawings represent portions of the portable electronic device that form no part of the claimed design. The dot-dash lines in the drawings illustrate the bounds of the claim and form no part thereof.

1 Claim, 6 Drawing Sheets

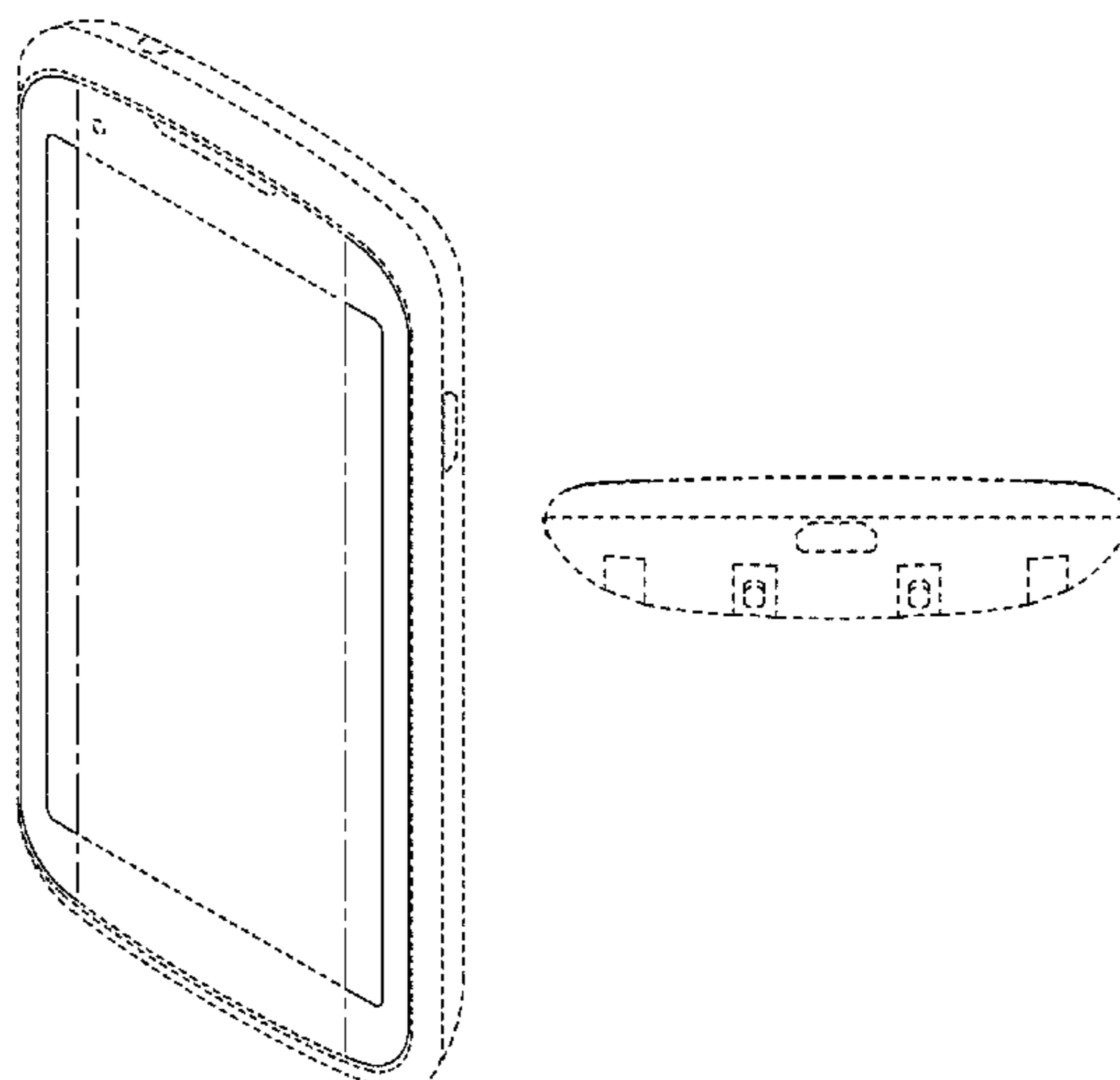

(56)

References Cited

U.S. PATENT DOCUMENTS

- D619,989 S * 7/2010 Huang D14/138 G
D622,270 S * 8/2010 Andre et al. D14/341
D626,937 S * 11/2010 Yeo et al. D14/203.7
D627,777 S * 11/2010 Akana et al. D14/341
D629,779 S * 12/2010 Ahn et al. D14/138 G
D634,319 S * 3/2011 Andre et al. D14/341
D634,725 S * 3/2011 Ewing et al. D14/138 G
D639,765 S * 6/2011 Lee D14/138 G
D639,805 S * 6/2011 Song et al. D14/341
D640,663 S * 6/2011 Arnholt et al. D14/138 G
D641,018 S * 7/2011 Lee et al. D14/341
D643,827 S * 8/2011 Lee et al. D14/138 G
D644,195 S * 8/2011 Kim et al. D14/138 G
D644,196 S * 8/2011 Lee et al. D14/138 AD
D644,197 S * 8/2011 Lee et al. D14/138 G
D645,010 S * 9/2011 Lee et al. D14/138 G
D645,836 S * 9/2011 Choi et al.
D646,248 S * 10/2011 Lee D14/138 G
D646,251 S * 10/2011 Park et al. D14/138 G
D646,662 S * 10/2011 Kim D14/138 G
D650,352 S * 12/2011 Cho D14/138 G
D652,007 S * 1/2012 Kim et al. D14/138 G
D652,404 S * 1/2012 Okada et al. D14/138 G
D654,047 S * 2/2012 Kim et al. D14/138 G
D654,048 S * 2/2012 Ichinose et al. D14/138 G
D654,463 S * 2/2012 Han D14/138 G
D654,889 S * 2/2012 Kim et al. D14/138 G
D657,764 S * 4/2012 Hong D14/138 G
D662,484 S * 6/2012 Sunderland D14/138 R
D662,489 S * 6/2012 Yeo D14/203.7
D663,298 S * 7/2012 Song et al. D14/341
D667,006 S * 9/2012 Van Den Nieuwenhuizen et al.
D667,396 S * 9/2012 Koh D14/341
D668,650 S * 10/2012 Han D14/341
D669,448 S * 10/2012 Hong D14/138 G
8,291,341 B2 10/2012 Tseng et al.
D670,259 S * 11/2012 Gioscia et al. D14/138 AD
D671,086 S * 11/2012 Yu et al. D14/138 G
D671,514 S * 11/2012 Kim et al. D14/138 G
8,311,514 B2 11/2012 Bandyopadhyay et al.
D672,345 S * 12/2012 Li D14/341
D672,739 S * 12/2012 Sin D14/138 G
D674,369 S * 1/2013 JaeWoong D14/138 G
D675,203 S * 1/2013 Yang D14/341
D676,819 S * 2/2013 Choi D14/138 G
D676,824 S * 2/2013 Lee D14/138 G
D677,644 S * 3/2013 Park D14/138 G
D677,660 S * 3/2013 Groene et al. D14/341
D678,271 S * 3/2013 Chiu D14/341
D681,584 S * 5/2013 Sung D14/138 G
D686,177 S * 7/2013 Lee D14/138 G
D687,002 S * 7/2013 Song et al. D14/138 G
D687,823 S * 8/2013 Ryu et al. D14/341
D687,824 S * 8/2013 Chun et al. D14/341
D687,825 S * 8/2013 Lee et al. D14/341
D689,481 S * 9/2013 Song et al. D14/341
D691,133 S * 10/2013 Akana et al. D14/341
D691,980 S * 10/2013 Park D14/138 G
D692,423 S * 10/2013 Kim et al. D14/341
D692,880 S * 11/2013 Song et al. D14/341
D692,881 S * 11/2013 Akana et al. D14/341
D693,341 S * 11/2013 Akana et al. D14/341
D696,247 S * 12/2013 Kim D14/341
D696,662 S * 12/2013 Song et al. D14/341
D696,664 S * 12/2013 Iida et al. D14/342
D698,356 S * 1/2014 Park D14/345
D698,782 S * 2/2014 Hong D14/341
D698,783 S * 2/2014 Hong D14/341
D698,785 S * 2/2014 Canizares et al. D14/341
D698,786 S * 2/2014 Jondrow et al. D14/341
D700,179 S * 2/2014 Hong D14/341
D700,180 S * 2/2014 Hong D14/341
D700,605 S * 3/2014 Hong D14/341
D701,191 S * 3/2014 Suk D14/138 G
D701,202 S * 3/2014 Choi D14/341
D708,160 S * 7/2014 Wooseung D14/138 G
D710,814 S * 8/2014 Im D14/138 G
D710,816 S * 8/2014 Koh D14/138 G
D711,343 S * 8/2014 Lee D14/138 G
D712,862 S * 9/2014 Kang D14/138 G
D712,864 S * 9/2014 Hirota D14/138 G
2010/0333043 A1 * 12/2010 Faris et al. 715/863

OTHER PUBLICATIONS

- U.S. Appl. No. 29/453,836, filed May 3, 2013, JaeWoong Chung.
U.S. Appl. No. 29/453,840, filed May 3, 2013, JaeWoong Chung.
U.S. Appl. No. 29/453,844, filed May 3, 2013, JaeWoong Chung.
U.S. Appl. No. 29/453,852, filed May 3, 2013, JaeWoong Chung.
U.S. Appl. No. 29/453,864, filed May 3, 2013, JaeWoong Chung.
U.S. Appl. No. 29/453,872, filed May 3, 2013, JaeWoong Chung.
U.S. Appl. No. 29/453,876, filed May 3, 2013, JaeWoong Chung.
U.S. Appl. No. 29/453,926, filed May 3, 2013, JaeWoong Chung.
U.S. Appl. No. 29/453,936, filed May 3, 2013, JaeWoong Chung.
S. Gilbert, "Apple Debuts New iPhone 4," *Metue: The Business of Media, Entertainment & Technology*, Jun. 7, 2010 [online], [retrieved on Apr. 19, 2013]. [Retrieved from the Internet <URL: <http://metue.com/06-07-2010/apple-debuts-new-iphone-4/>>].
A. Almeida, "LG Nitro HD makes its U.S debut," *Tech2.com India*, Dec. 2, 2011 [online], [retrieved on Apr. 25, 2013]. [Retrieved from the Internet <URL: <http://tech2.in.com/news/smartphones/lg-nitro-hd-makes-its-us-debut/262002>>].

* cited by examiner

FIG.1

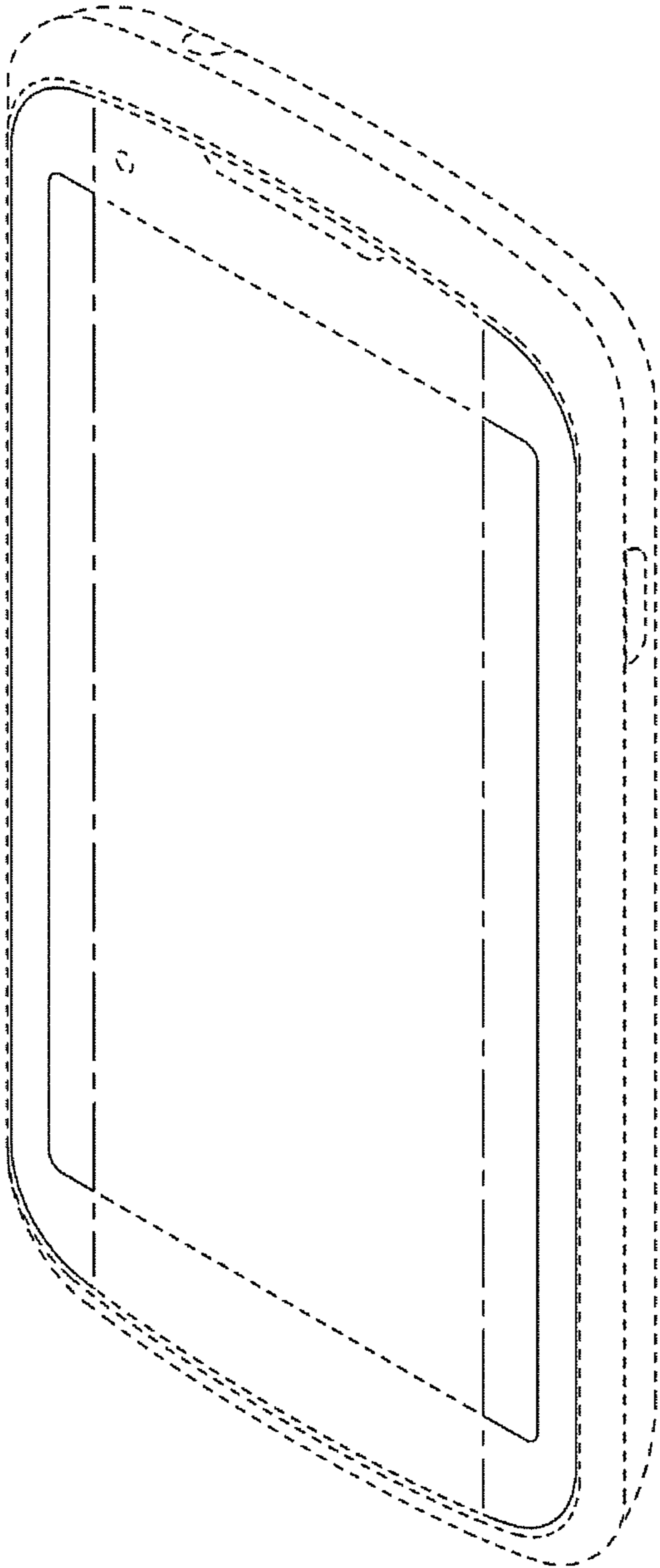

FIG.2

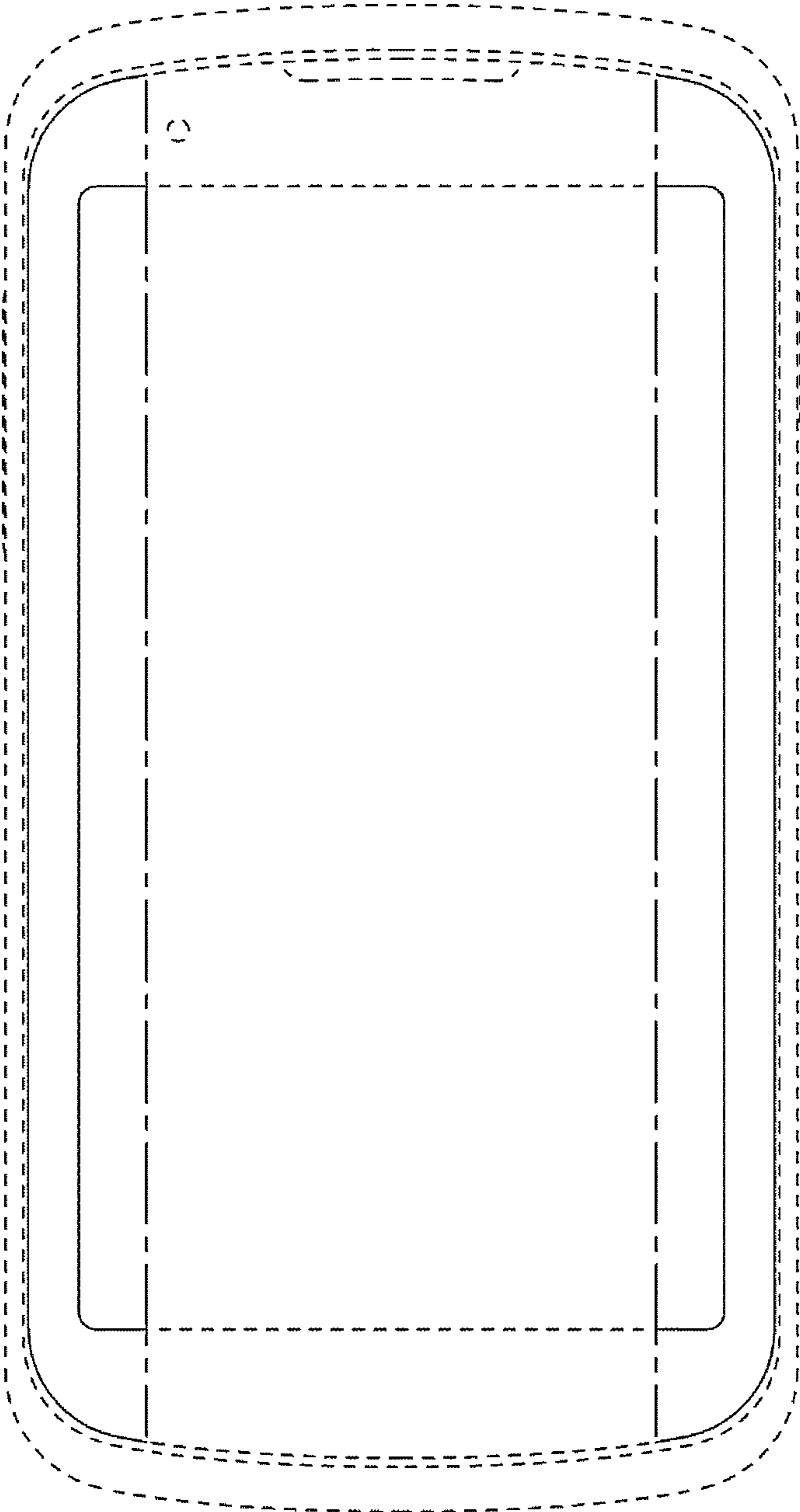

FIG.3

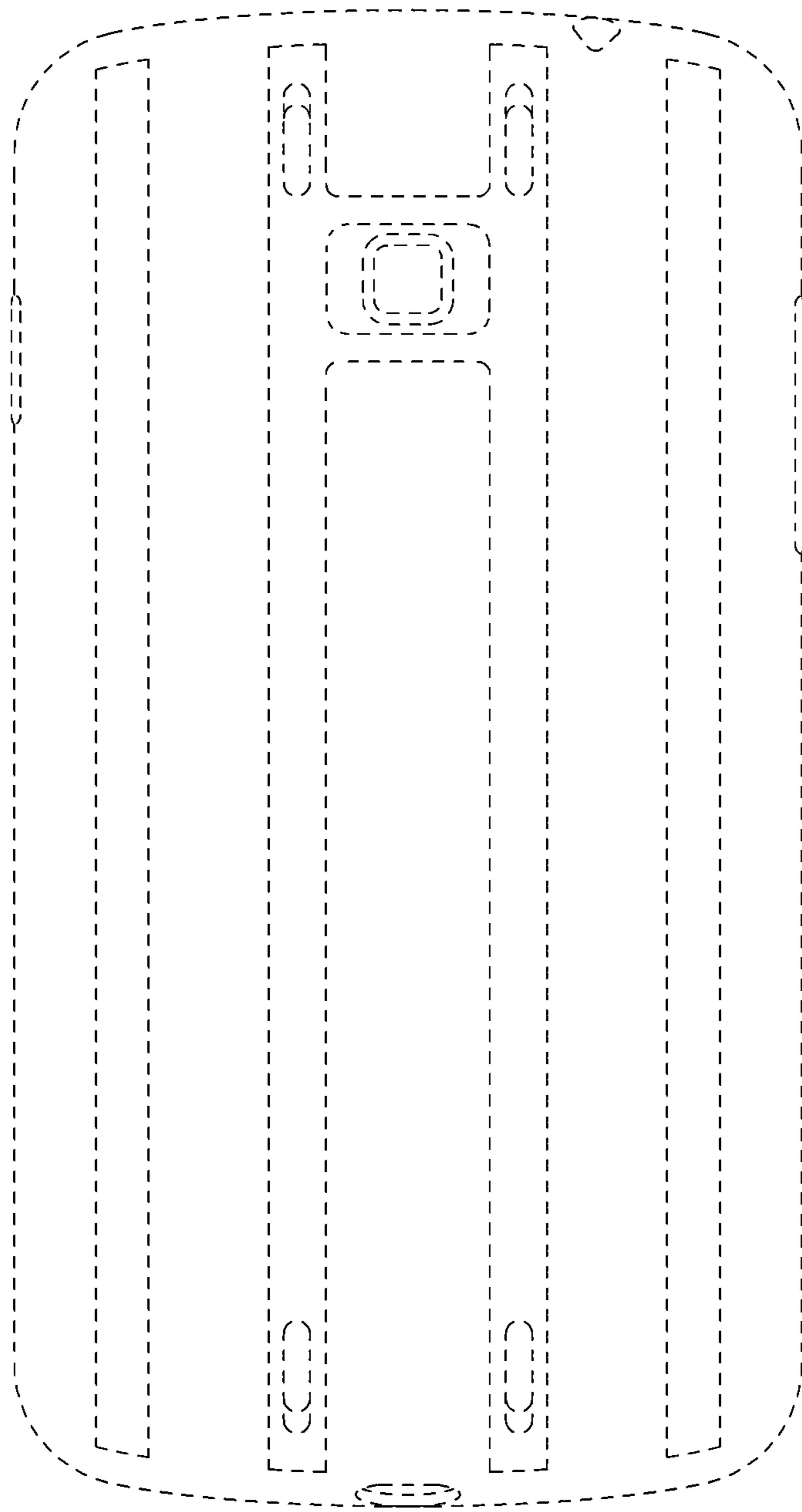

FIG.4

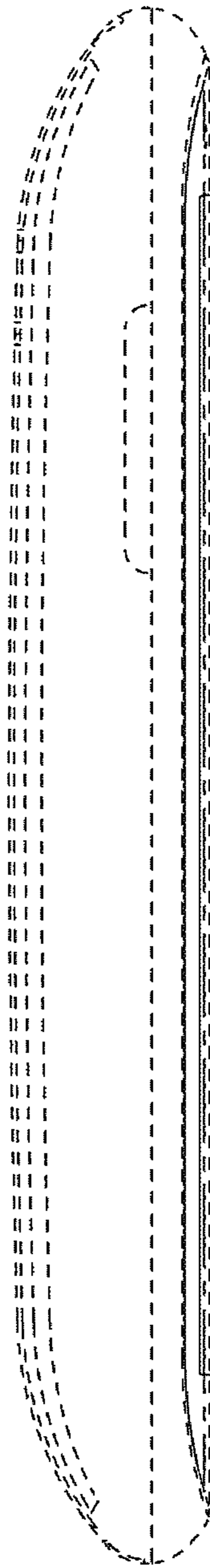

FIG.5

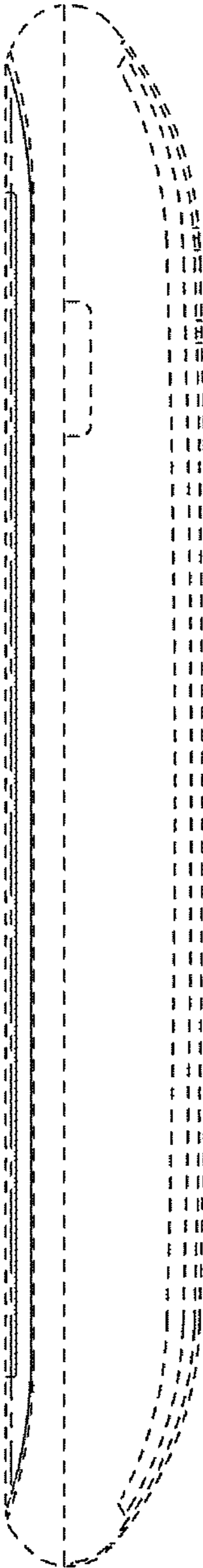

FIG.6

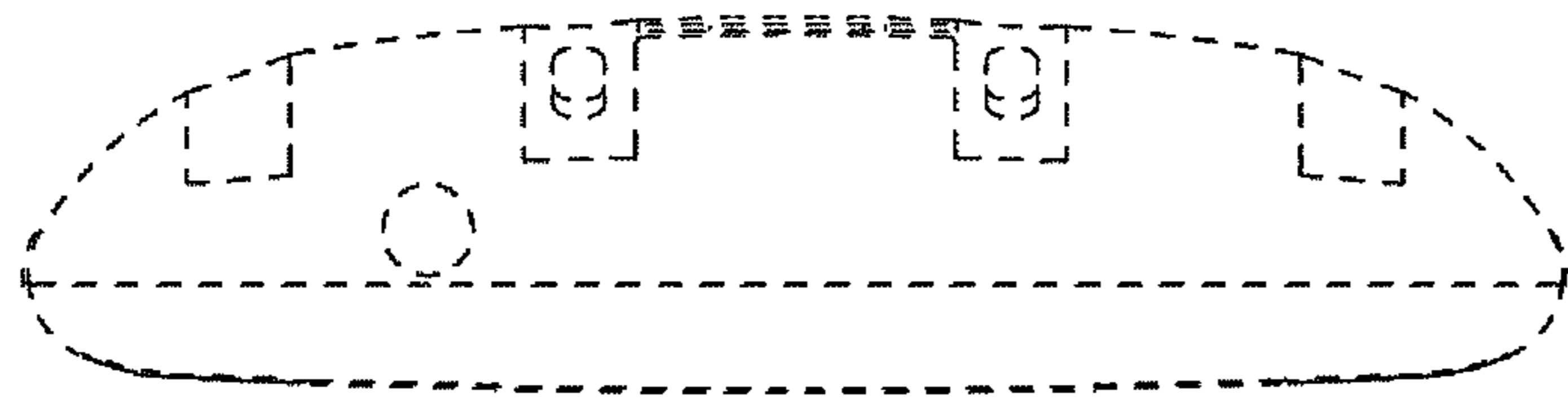

FIG.7

