



US00D733122S

(12) **United States Design Patent**
Lee

(10) **Patent No.:** **US D733,122 S**
(45) **Date of Patent:** **** Jun. 30, 2015**

(54) **NOTEBOOK COMPUTER**

(71) Applicant: **Samsung Electronics Co., Ltd.**,
Suwon-si, Gyeonggi-do (KR)

(72) Inventor: **Jung Hun Lee**, Yongin-si (KR)

(73) Assignee: **SAMSUNG ELECTRONICS CO., LTD.** (KR)

(**) Term: **14 Years**

(21) Appl. No.: **29/476,489**

(22) Filed: **Dec. 13, 2013**

(30) **Foreign Application Priority Data**

Jun. 14, 2013 (KR) 30-2013-0030775

(51) **LOC (10) Cl.** **14-02**

(52) **U.S. Cl.**
USPC **D14/327**

(58) **Field of Classification Search**
USPC D14/315-327, 391-399, 455, 456;
D18/1, 2, 7, 11; 235/145 A, 145 R;
341/22, 23; 345/104, 156, 168, 169,
345/173; 361/679.08, 679.09, 679.11,
361/679.26, 679.27

See application file for complete search history.

(56) **References Cited**

U.S. PATENT DOCUMENTS

6,519,139 B2 * 2/2003 Kambayashi 361/679.09
D606,534 S * 12/2009 Hong et al. D14/315

D631,472 S * 1/2011 Kawase et al. D14/327
D633,488 S * 3/2011 Kim et al. D14/315
D652,417 S * 1/2012 Lee et al. D14/315
D682,828 S * 5/2013 Kim et al. D14/327
D686,203 S * 7/2013 Lee et al. D14/315

* cited by examiner

Primary Examiner — Freda S Nunn

(74) *Attorney, Agent, or Firm* — Cantor Colburn LLP

(57) **CLAIM**

The ornamental design for a notebook computer, as shown and described.

DESCRIPTION

FIG. 1 is the front perspective view of a notebook computer showing my new design;
FIG. 2 is the front view thereof;
FIG. 3 is the rear view thereof;
FIG. 4 is the left-side view thereof;
FIG. 5 is the right-side view thereof;
FIG. 6 is the top-side plan view thereof;
FIG. 7 is the bottom-side plan view thereof; and,
FIG. 8 is the front perspective view thereof in use environment.

The broken lines are for environmental purposes only and form no part of the claimed design.

The surface treatment of the notebook computer shown in the figures forms no part of the claimed design, a notebook computer according to the claimed design may have any surface treatment.

1 Claim, 8 Drawing Sheets

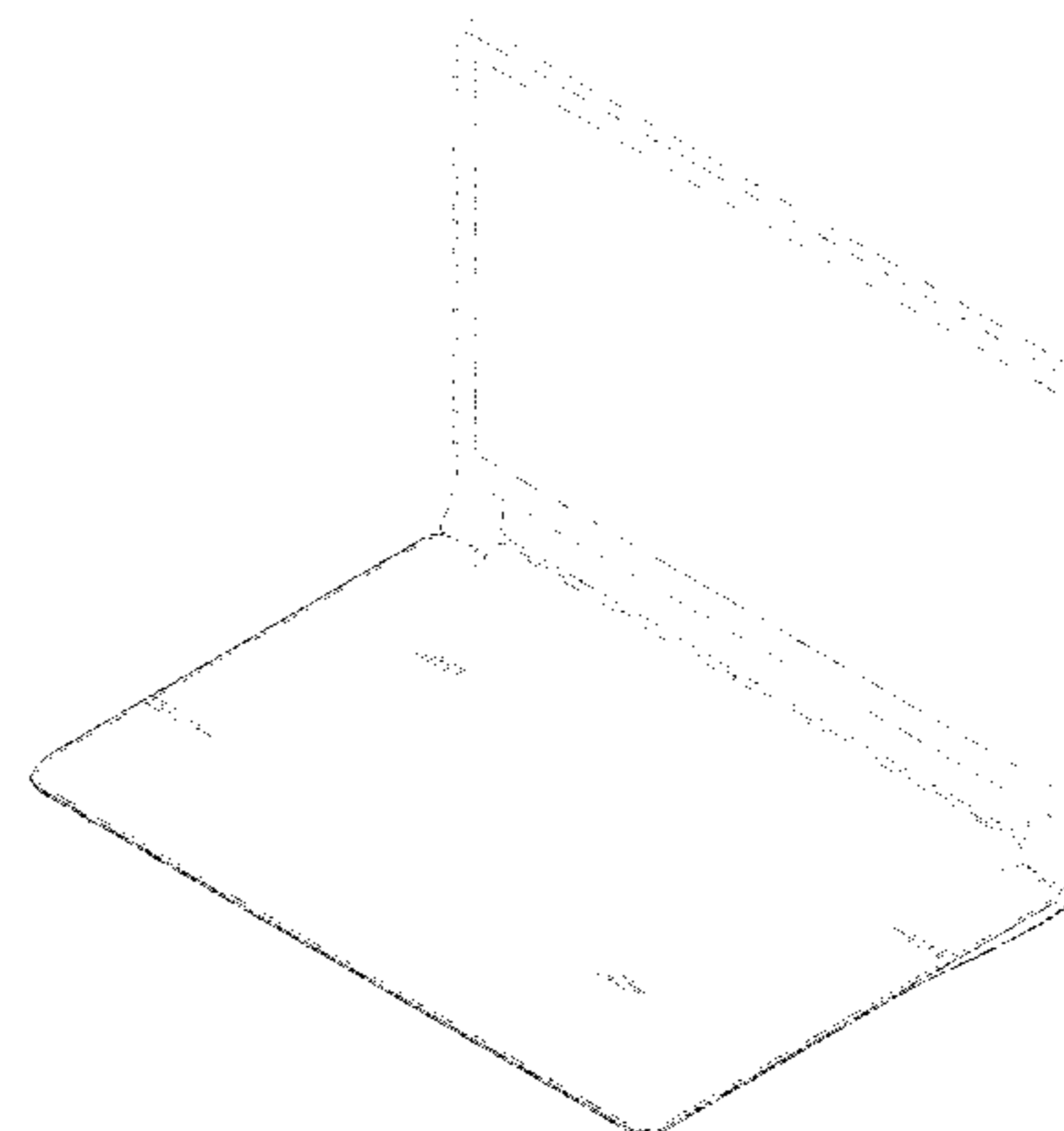
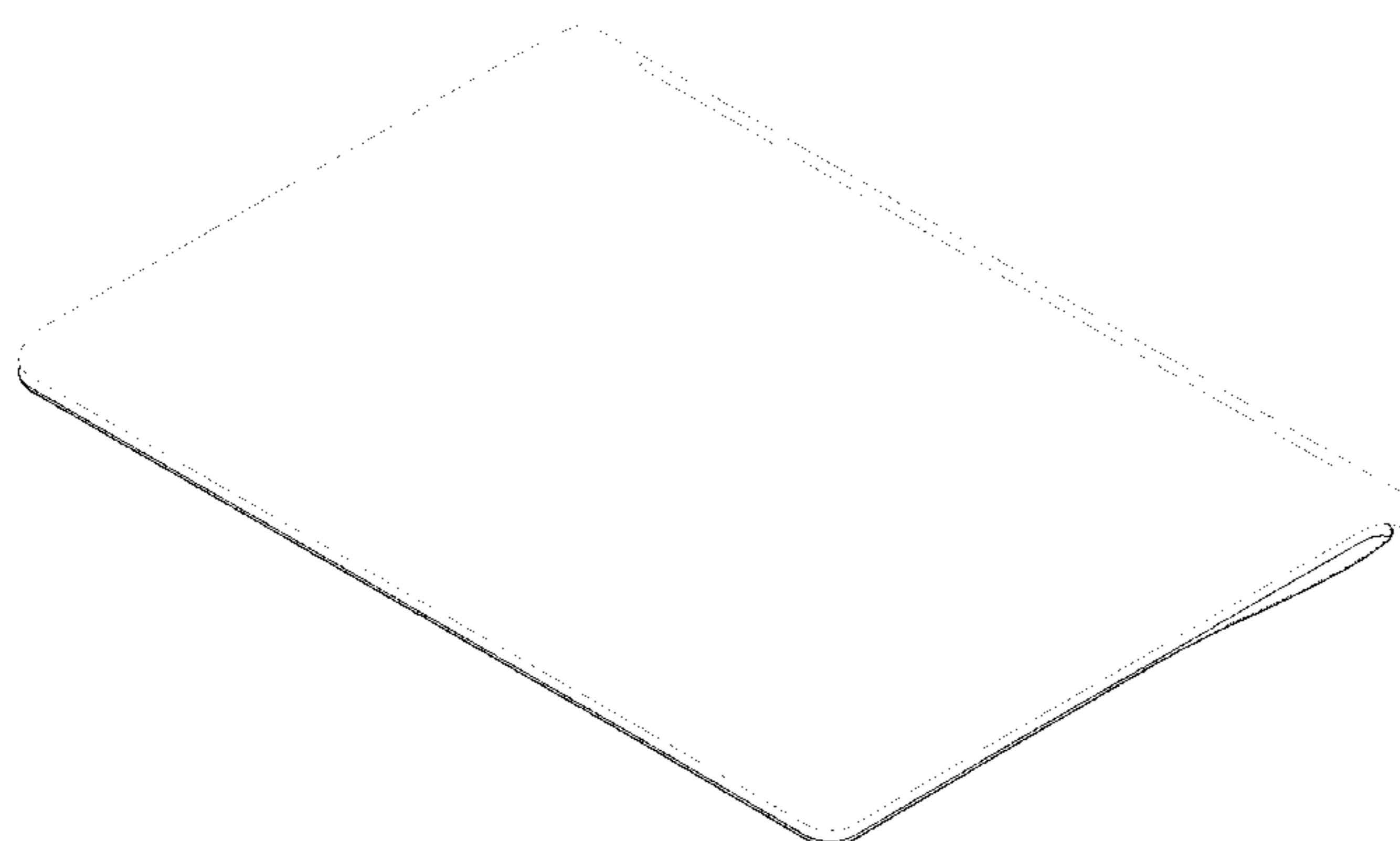

Fig. 1

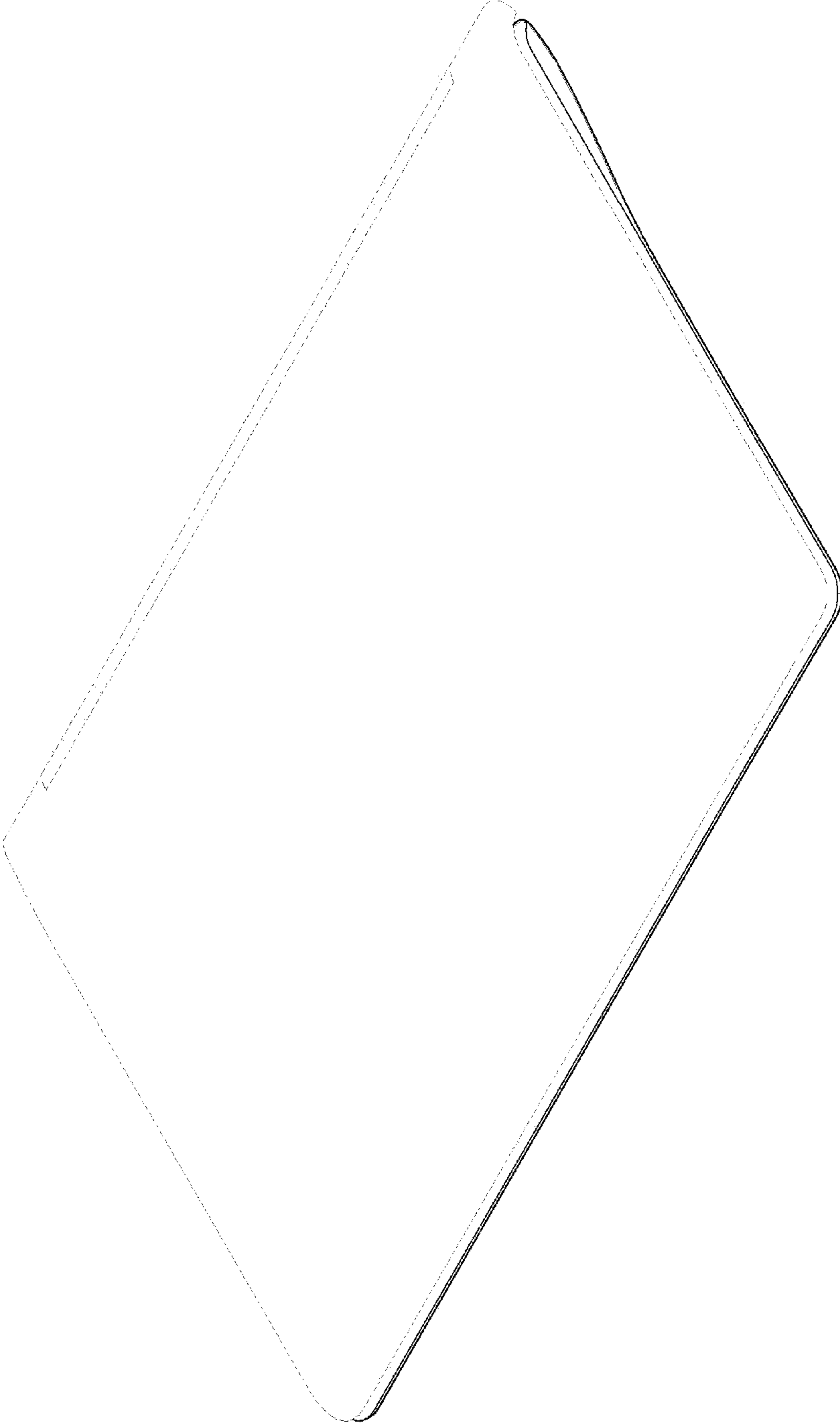

Fig. 2

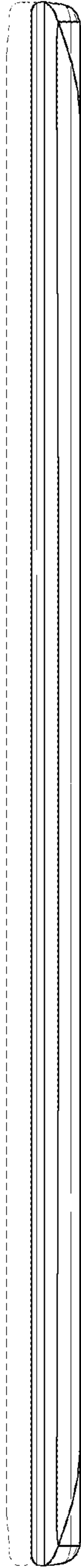

Fig. 3



Fig. 4

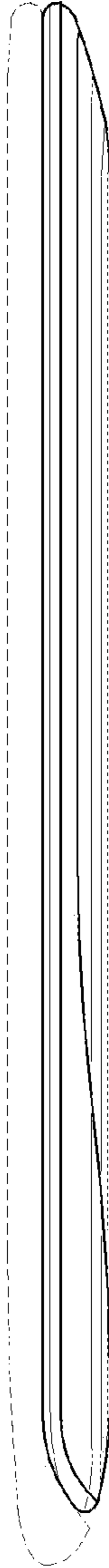

Fig. 5



Fig. 6

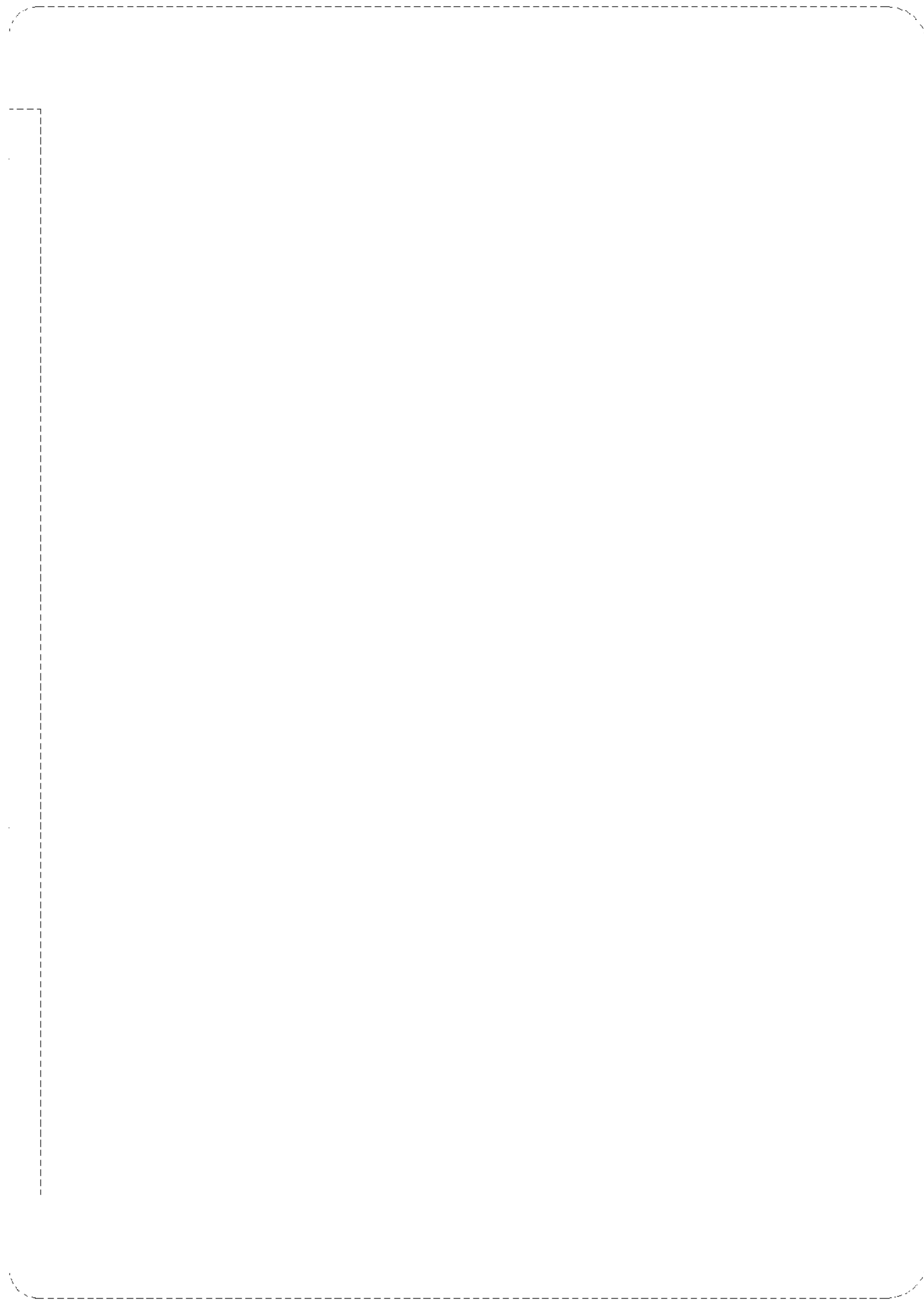

Fig. 7

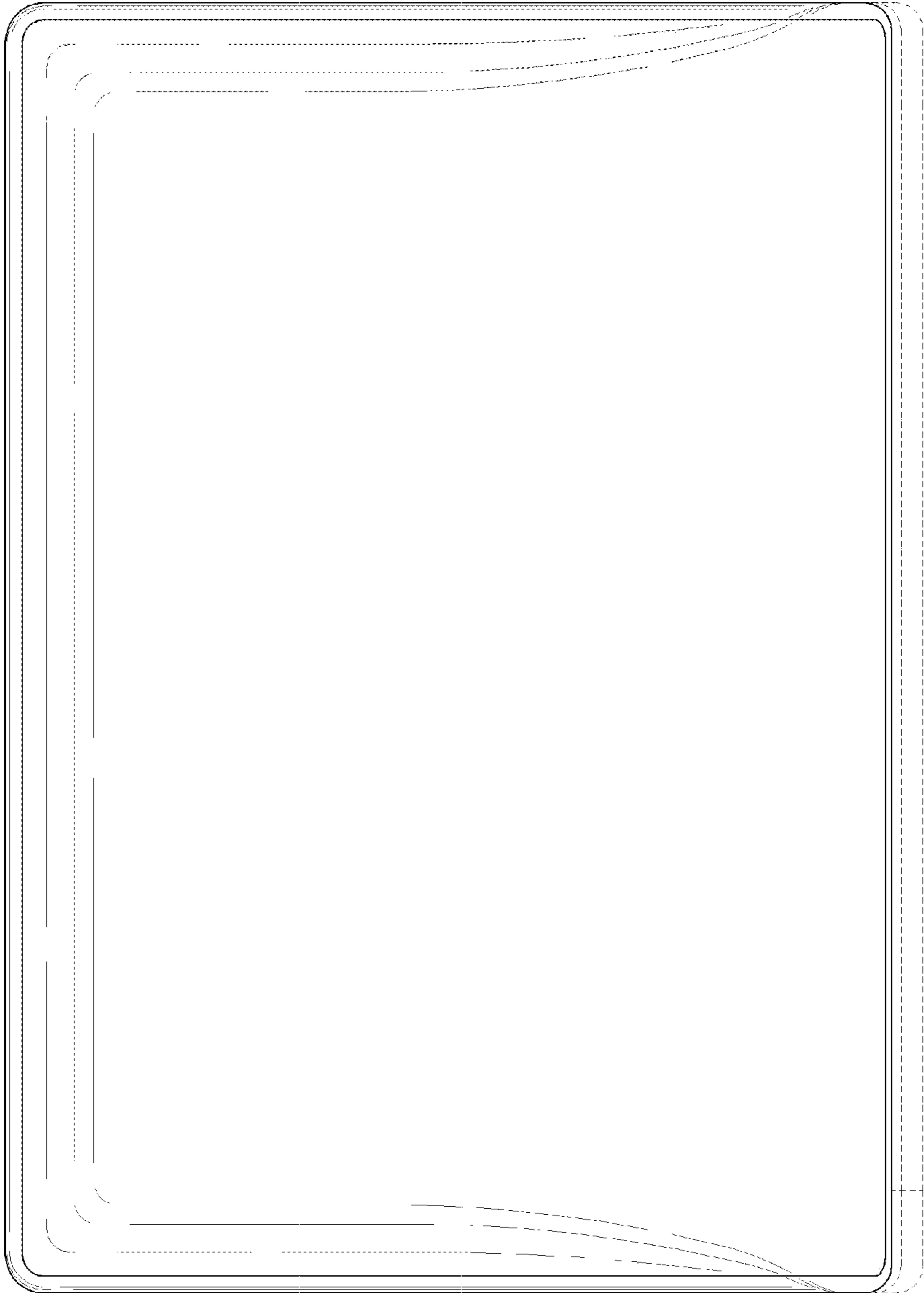

Fig. 8

