



US00D733111S

(12) **United States Design Patent**  
**Kim**

(10) **Patent No.:** **US D733,111 S**  
(45) **Date of Patent:** **\*\* \*Jun. 30, 2015**

- (54) **CASE FOR ELECTRONIC DEVICE**
- (71) Applicant: **Samsung Electronics Co., Ltd.**,  
Suwon-si, Gyeonggi-do (KR)
- (72) Inventor: **Yoon-Young Kim**, Seongnam-Si (KR)
- (73) Assignee: **Samsung Electronics Co., Ltd.**,  
Suwon-si (KR)
- (\*) Notice: This patent is subject to a terminal disclaimer.
- (\*\*) Term: **14 Years**

D641,348 S *	7/2011	Kim et al.	.....	D14/250
D647,892 S *	11/2011	Ragde, Jr.	.....	D14/238.1
D652,829 S *	1/2012	Kim et al.	.....	D14/250
D657,354 S *	4/2012	Kim	.....	D14/250
D669,270 S *	10/2012	Phillips et al.	.....	D3/301
D674,799 S *	1/2013	Kim	.....	D14/440
D674,800 S *	1/2013	Kim	.....	D14/440
D677,888 S *	3/2013	Sogabe	.....	D3/269
D685,799 S *	7/2013	Canizares et al.	.....	D14/440
D685,800 S *	7/2013	Canizares et al.	.....	D14/440
D685,801 S *	7/2013	Canizares et al.	.....	D14/440
D685,802 S *	7/2013	Canizares et al.	.....	D14/440
D694,741 S *	12/2013	Kim	.....	D14/250
D694,744 S *	12/2013	Kim	.....	D14/250

(Continued)

- (21) Appl. No.: **29/448,697**
- (22) Filed: **Mar. 13, 2013**
- (51) **LOC (10) Cl.** ..... **14-03**
- (52) **U.S. Cl.**  
USPC ..... **D14/250**
- (58) **Field of Classification Search**  
USPC ..... D14/238.1, 248, 250, 251–253, 440,  
D14/447; D13/103, 107–108, 119; D3/201,  
D3/218, 247, 269, 273, 301, 303; 361/220,  
361/379.01, 679.01, 679.02, 679.09,  
361/679.21, 679.25, 679.3, 679.4, 679.56,  
361/679.57, 759, 807, 816; 379/433.11,  
379/451, 455; 455/556.1, 557, 566, 575.1,  
455/575.2, 575.8; 206/37, 45.2, 305, 320,  
206/216; 320/108, 115; 429/96; 220/4.02;  
150/165; 174/50; 235/41, 375, 462;  
312/223.1; 396/535; 248/176.3, 188.8,  
248/309.1, 371, 668  
See application file for complete search history.

**FOREIGN PATENT DOCUMENTS**

EP 2408176 A1 \* 1/2012 ..... H04M 1/04

*Primary Examiner* — Carla Jobe Wright  
(74) *Attorney, Agent, or Firm* — NSIP Law

(57) **CLAIM**

I claim the ornamental design for a case for electronic device, as shown and described.

**DESCRIPTION**

FIG. 1 is a front perspective view of a case for electronic device showing our new design;  
 FIG. 2 is a front view thereof;  
 FIG. 3 is a rear view thereof;  
 FIG. 4 is a left-side view thereof;  
 FIG. 5 is a right-side view thereof;  
 FIG. 6 is a top plan view thereof;  
 FIG. 7 is a bottom plan view thereof;  
 FIG. 8 is a perspective view thereof showing the case in an open state; and,  
 FIG. 9 is another perspective view thereof showing the case in an open state.  
 The broken lines immediately adjacent the shaded surfaces represent boundaries of the claimed design. All other broken lines depict unclaimed environment. The broken lines form no part of the claimed design.

**1 Claim, 7 Drawing Sheets**

(56) **References Cited**  
**U.S. PATENT DOCUMENTS**

D453,728 S *	2/2002	Hassett	.....	D12/417
6,599,657 B1 *	7/2003	Pollett et al.	.....	429/96
6,758,335 B2 *	7/2004	Kajiya	.....	206/320
D550,961 S *	9/2007	Eskandry	.....	D3/303
D551,846 S *	10/2007	Ko et al.	.....	D3/201

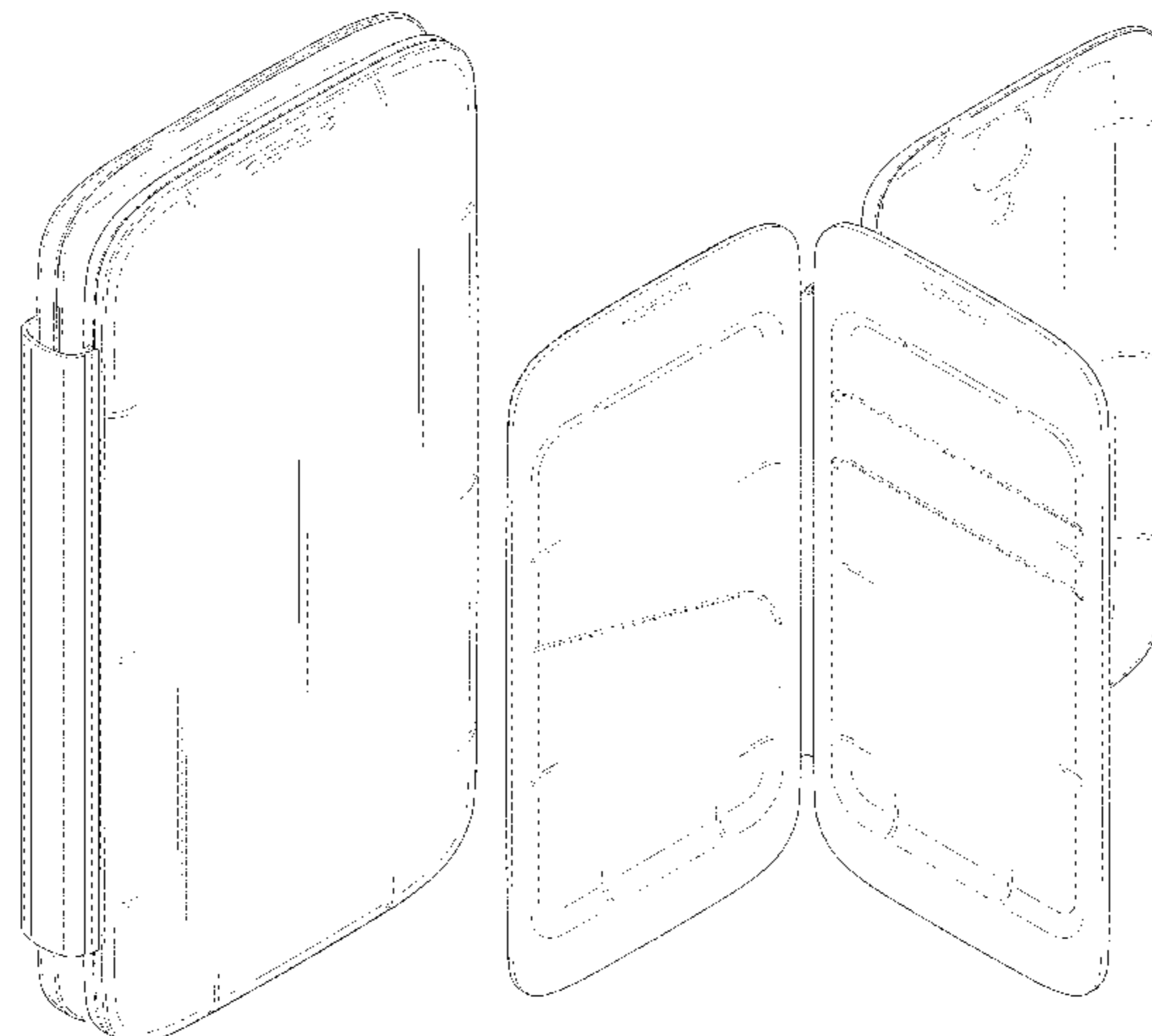

# US D733,111 S

Page 2

---

(56)

## References Cited

### U.S. PATENT DOCUMENTS

D700,599 S \* 3/2014 Kim ..... D14/250  
D702,673 S \* 4/2014 Murchison et al. .... D14/250  
D707,219 S \* 6/2014 Kim ..... D14/250

D710,607 S \* 8/2014 Kim ..... D3/269  
D710,838 S \* 8/2014 Song ..... D14/250  
2011/0290687 A1\* 12/2011 Han ..... 206/320  
2012/0085679 A1\* 4/2012 Kim et al. .... 206/736

\* cited by examiner

FIG. 1

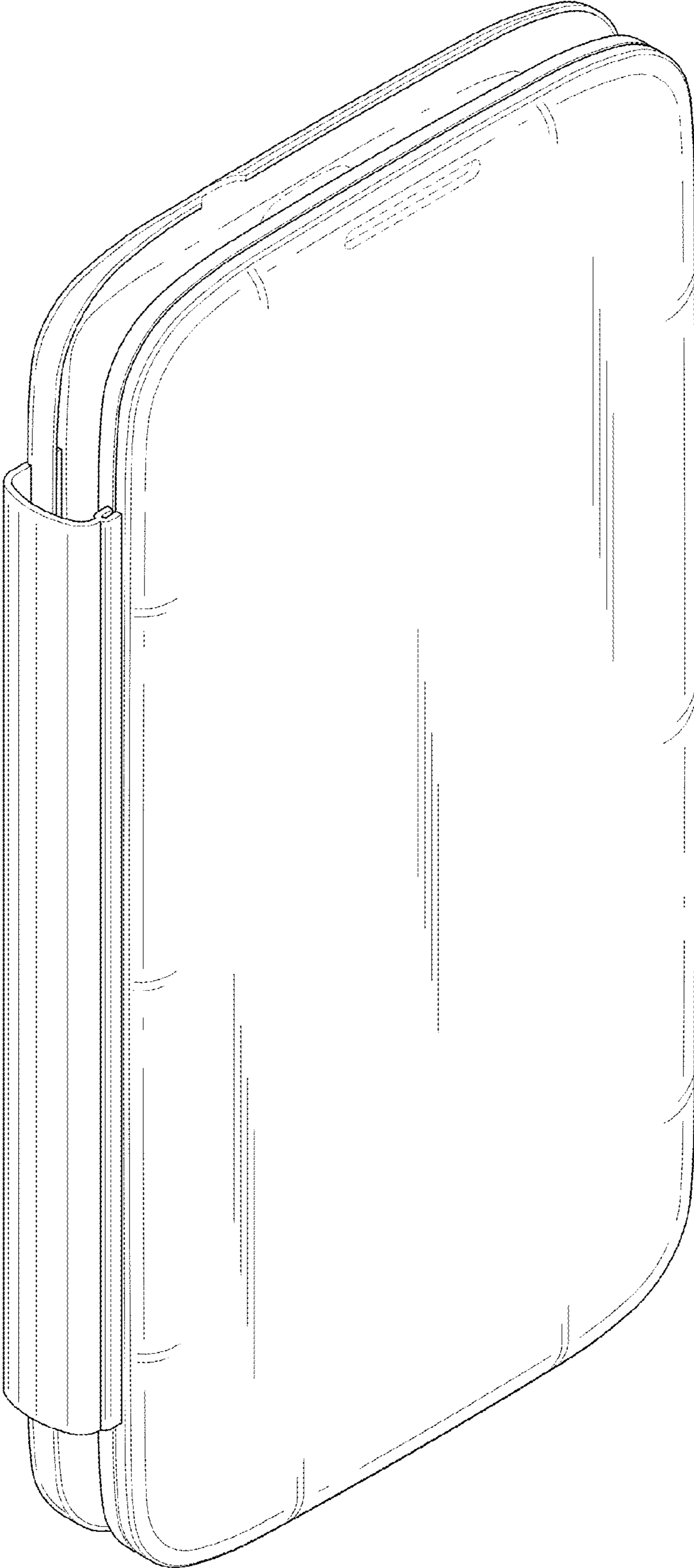

FIG. 2

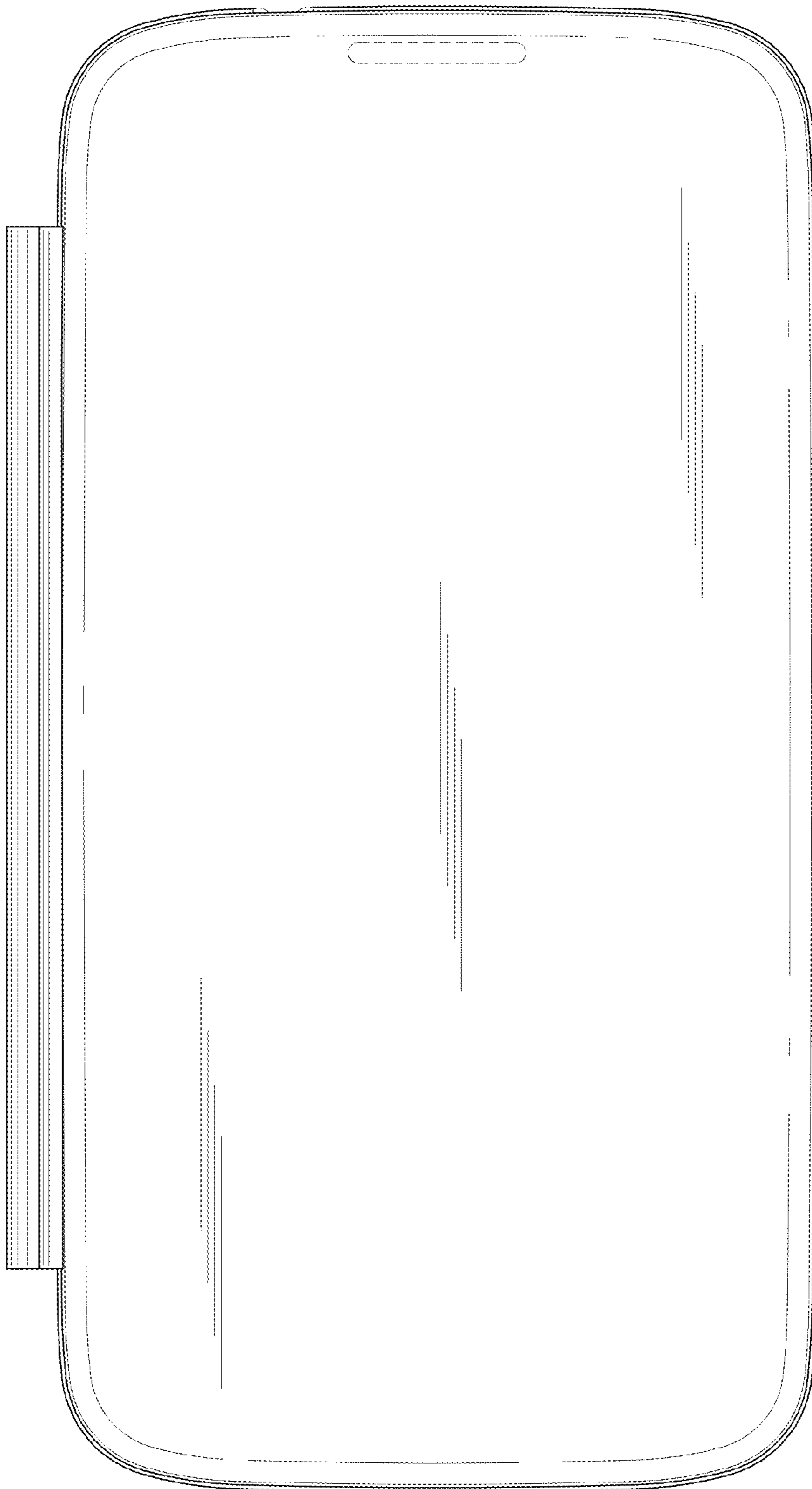

FIG. 3

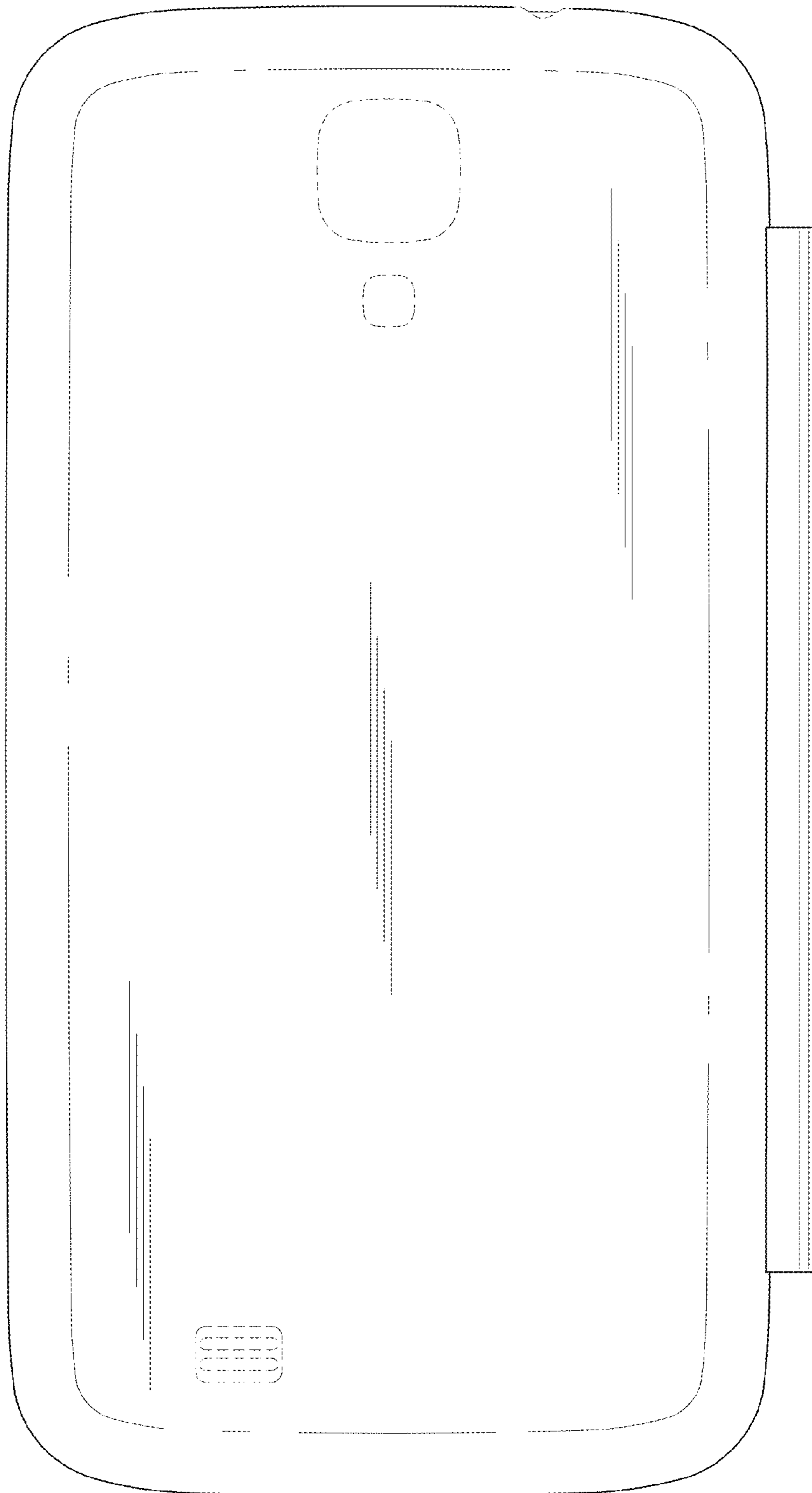

FIG. 4

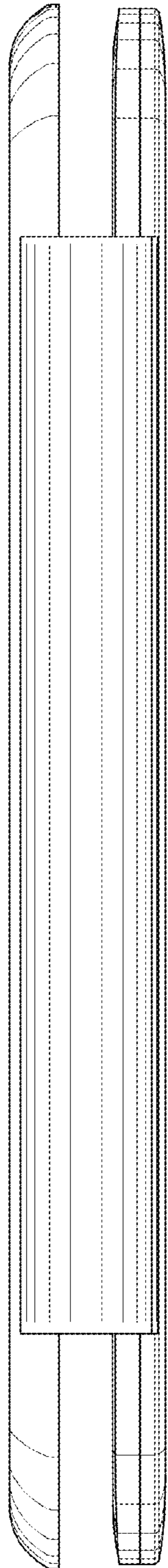

FIG. 5

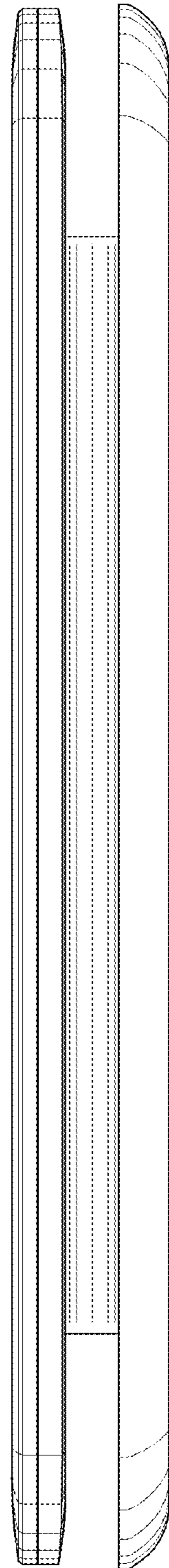

FIG. 6

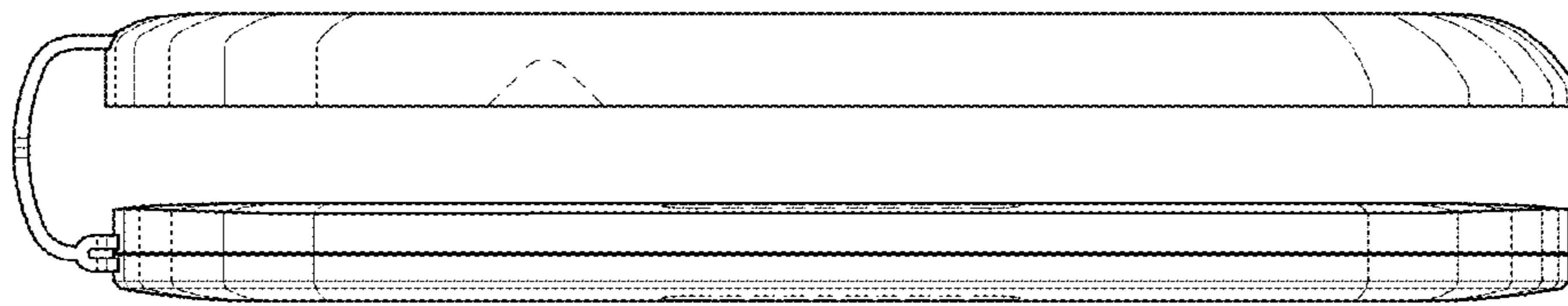

FIG. 7

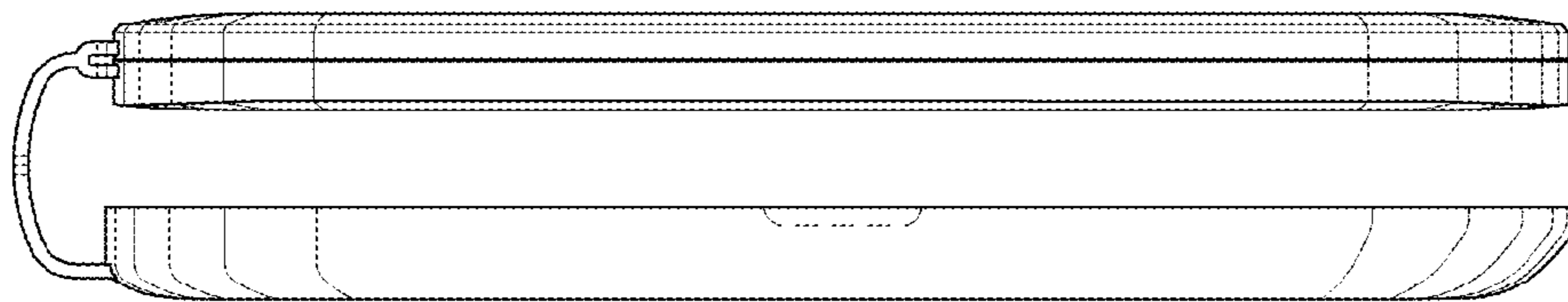

FIG. 8

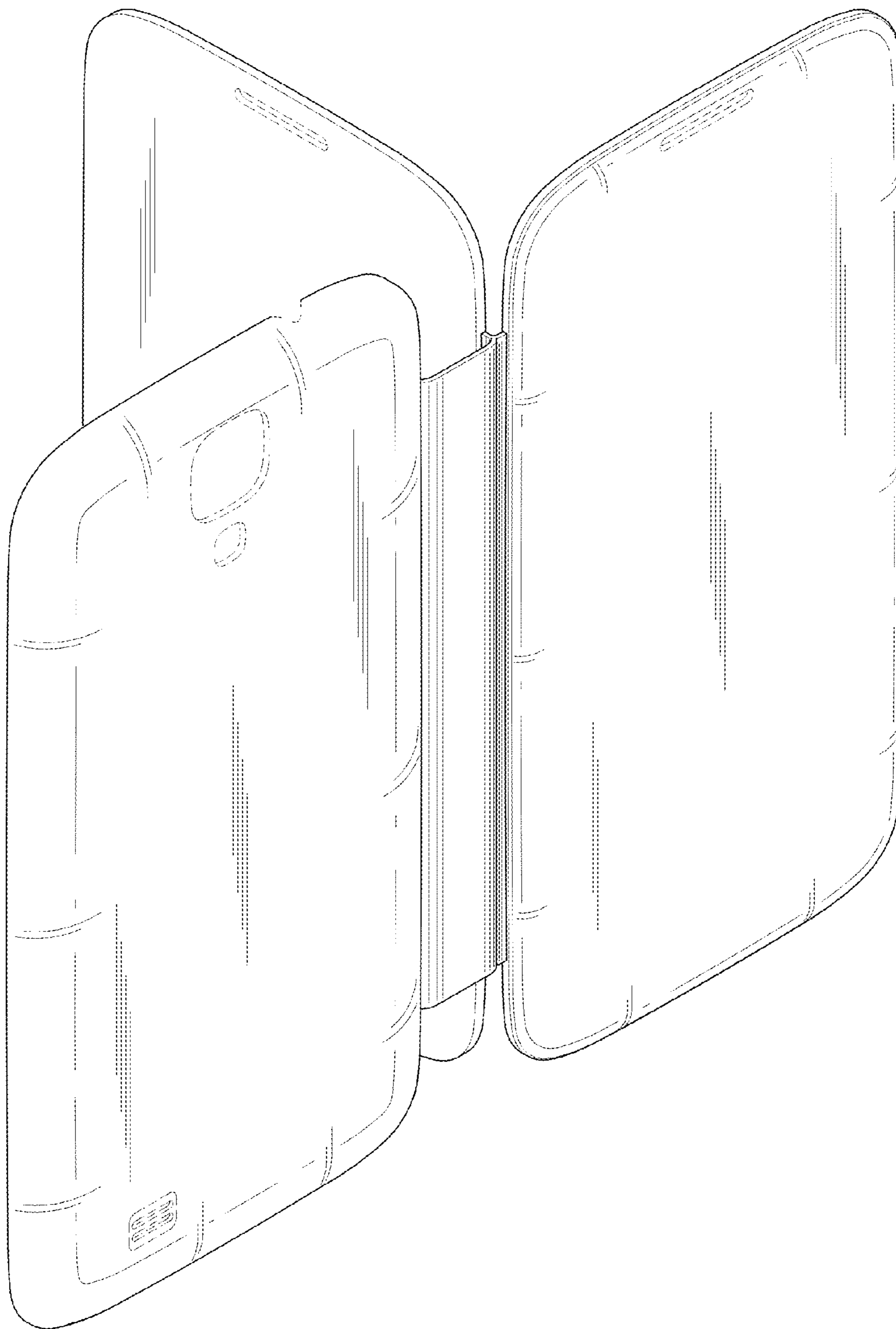



FIG. 9

