



US00D733005S

(12) **United States Design Patent**
Erwin

(10) **Patent No.:** **US D733,005 S**
(45) **Date of Patent:** **** Jun. 30, 2015**

(54) **TRAILER FRAME FOR FOOD PREPARATION AND SERVING**

D395,261 S * 6/1998 Puhl D12/102
D551,128 S * 9/2007 Renard D12/102
D630,558 S * 1/2011 Hopkins Clutterbuck
et al. D12/106

(71) Applicant: **Timothy Lee Erwin**, Azle, TX (US)

* cited by examiner

(72) Inventor: **Timothy Lee Erwin**, Azle, TX (US)

Primary Examiner — Katrina A Betton

(**) Term: **14 Years**

(74) *Attorney, Agent, or Firm* — Law Office of Jeff Williams; J. Oliver Williams

(21) Appl. No.: **29/479,803**

(22) Filed: **Jan. 20, 2014**

(51) **LOC (10) Cl.** **12-10**

(52) **U.S. Cl.**
USPC **D12/101**

(58) **Field of Classification Search**
USPC D12/100–106, 19, 129, 111–112;
D34/21–26, 12, 16–19; 280/204, 205,
280/63, 475, 482, 647; 296/168, 180,
296/180.2, 61, 10, 100.01–100.08;
D21/425, 435

See application file for complete search history.

(56) **References Cited**

U.S. PATENT DOCUMENTS

3,718,227 A * 2/1973 Swift D12/101
D255,520 S * 6/1980 Lyons D7/701
D295,271 S * 4/1988 Anderson D12/101
D316,688 S * 5/1991 Barginear D12/101
D322,235 S * 12/1991 Bell D12/101
D369,328 S * 4/1996 Acosta D12/101
D375,921 S * 11/1996 Kunkle D12/101

(57) **CLAIM**

The ornamental design for a trailer frame for food preparation and serving, as shown and described.

DESCRIPTION

FIG. 1 is an oblique view of a trailer frame for food preparation and serving according to the present application. FIG. 2 is a front view of the trailer frame of FIG. 1. FIG. 3 is a rear view of the trailer frame of FIG. 1. FIG. 4 is a right view of the trailer frame of FIG. 1. FIG. 5 is a left view of the trailer frame of FIG. 1. FIG. 6 is a top view of the trailer frame of FIG. 1. FIG. 7 is a bottom view of the trailer frame of FIG. 1. FIG. 8 is a rear oblique view of the trailer frame of FIG. 1. FIG. 9 is an alternative oblique view of the trailer frame of FIG. 1; and, FIG. 10 is a rear oblique view of the trailer frame of FIG. 9. The broken lines are included for the purpose of illustrating environmental structure and form no part of the claimed design.

1 Claim, 9 Drawing Sheets

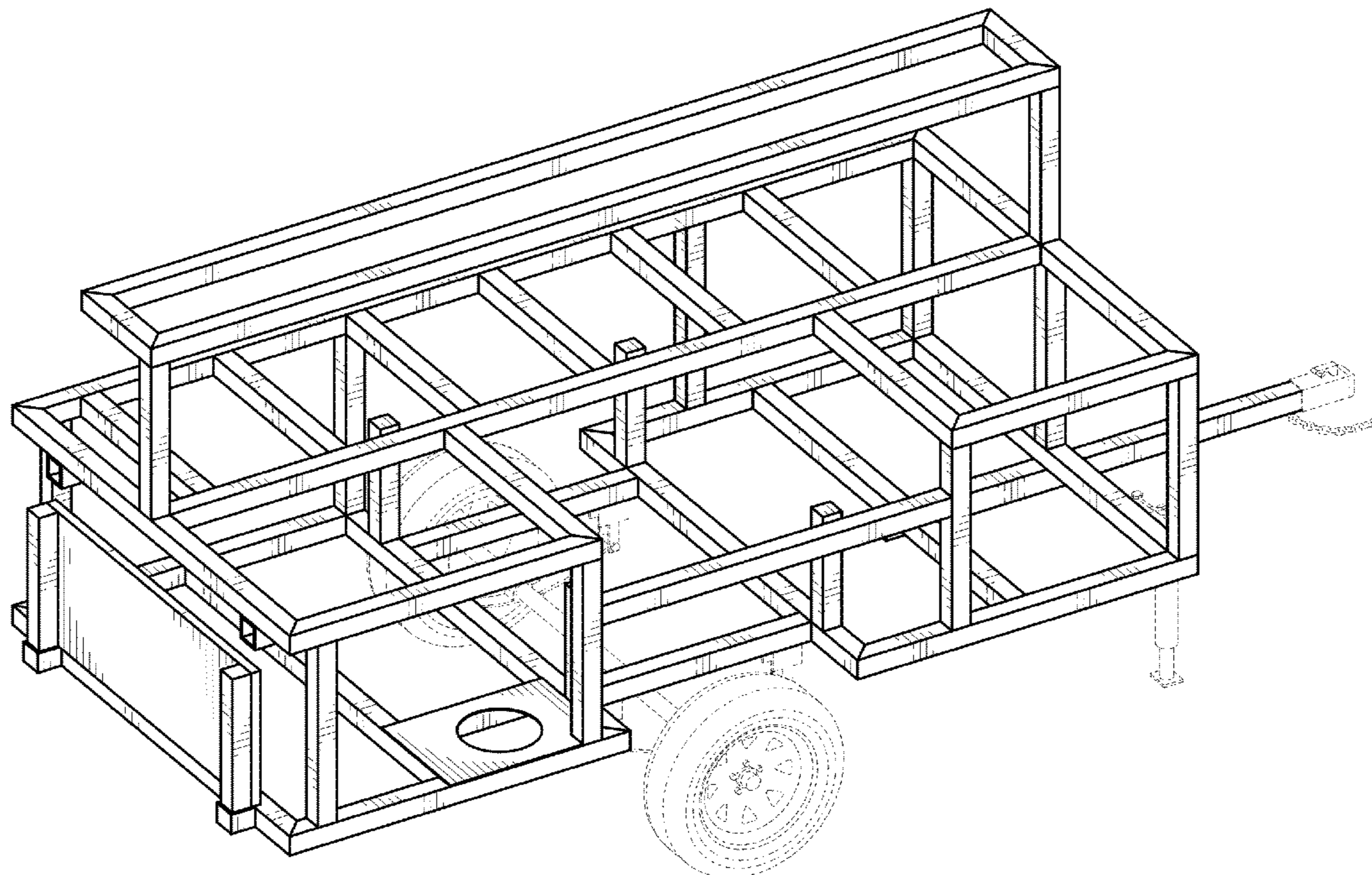

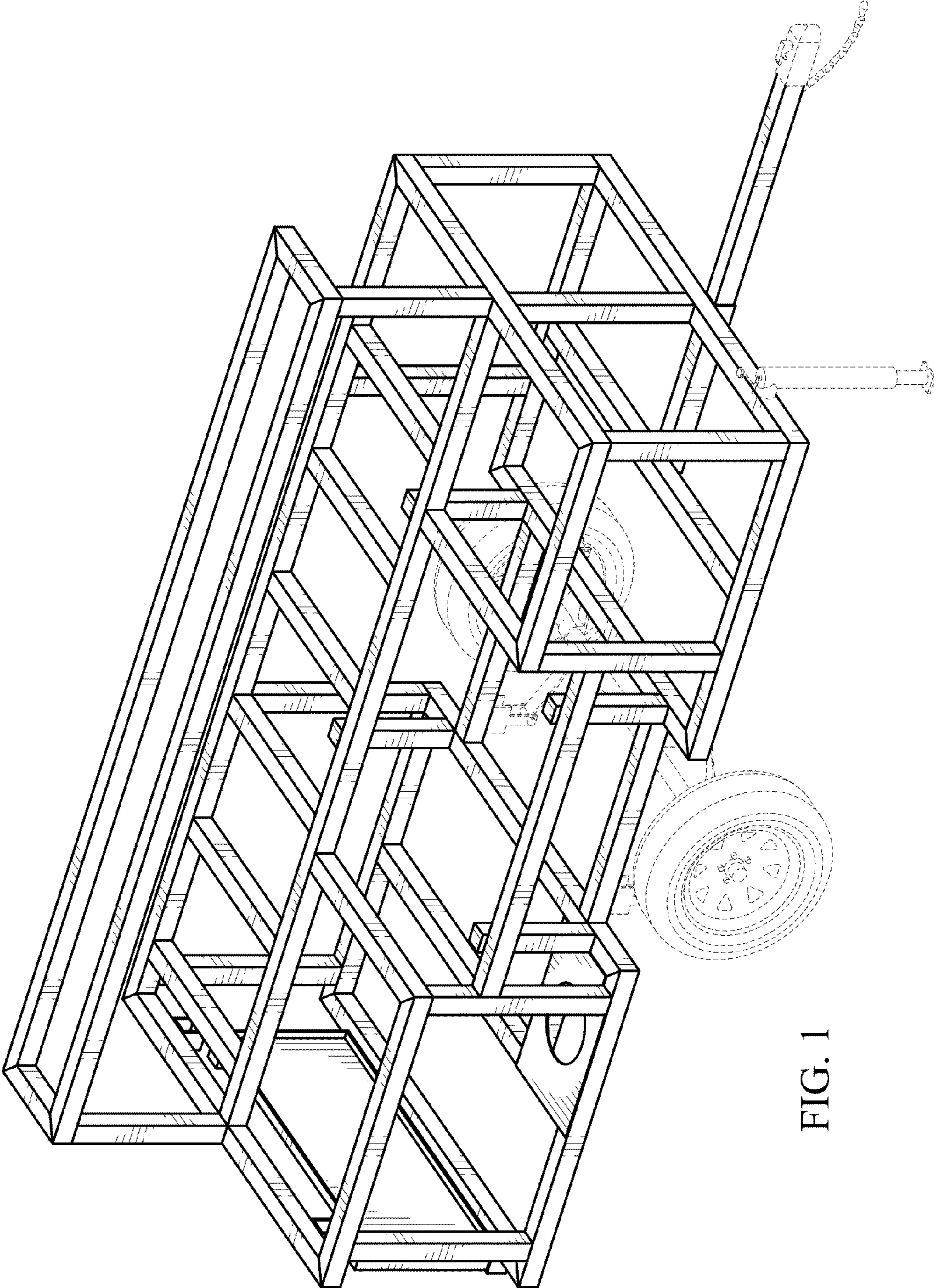

FIG. 1

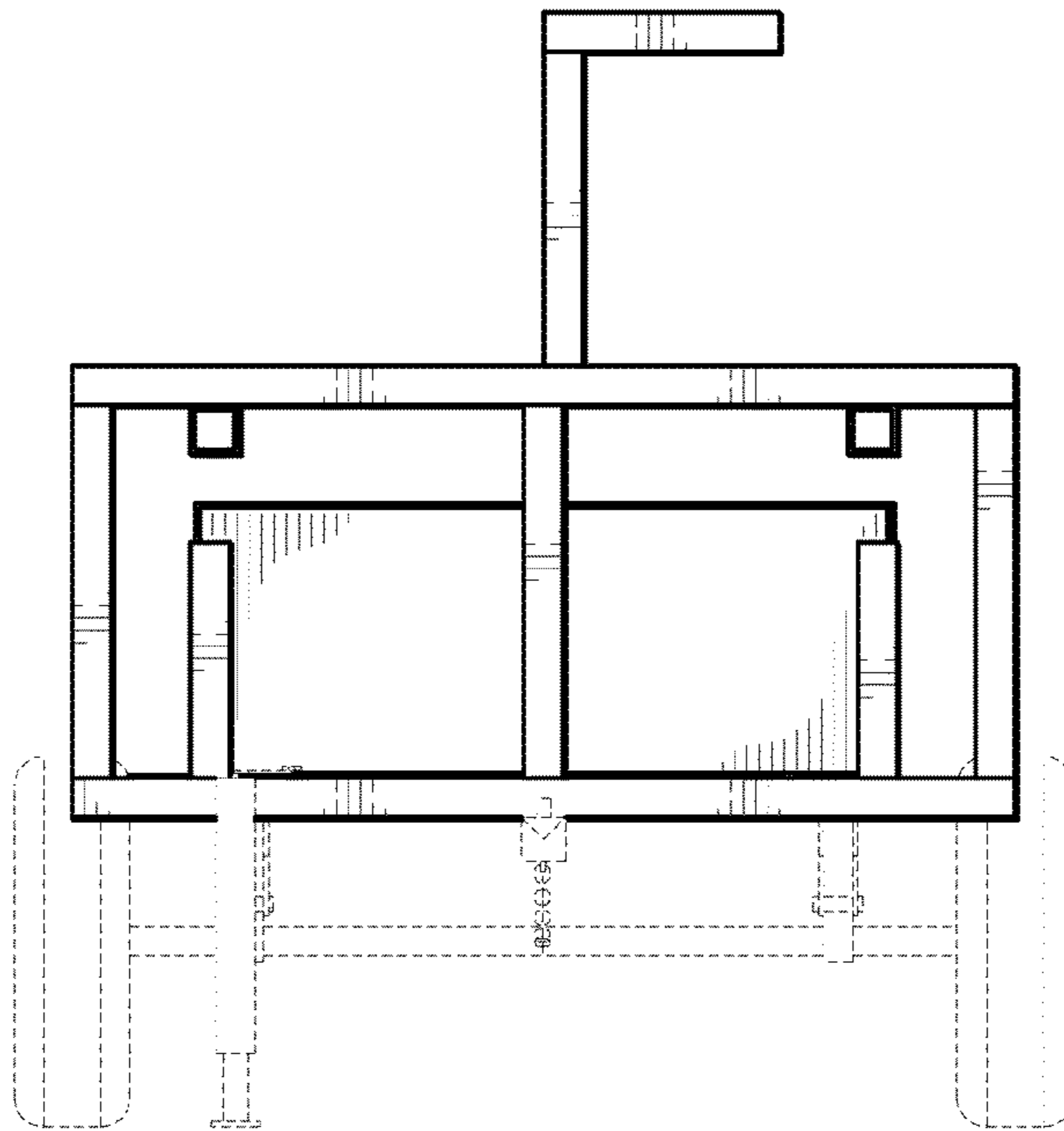

FIG. 2

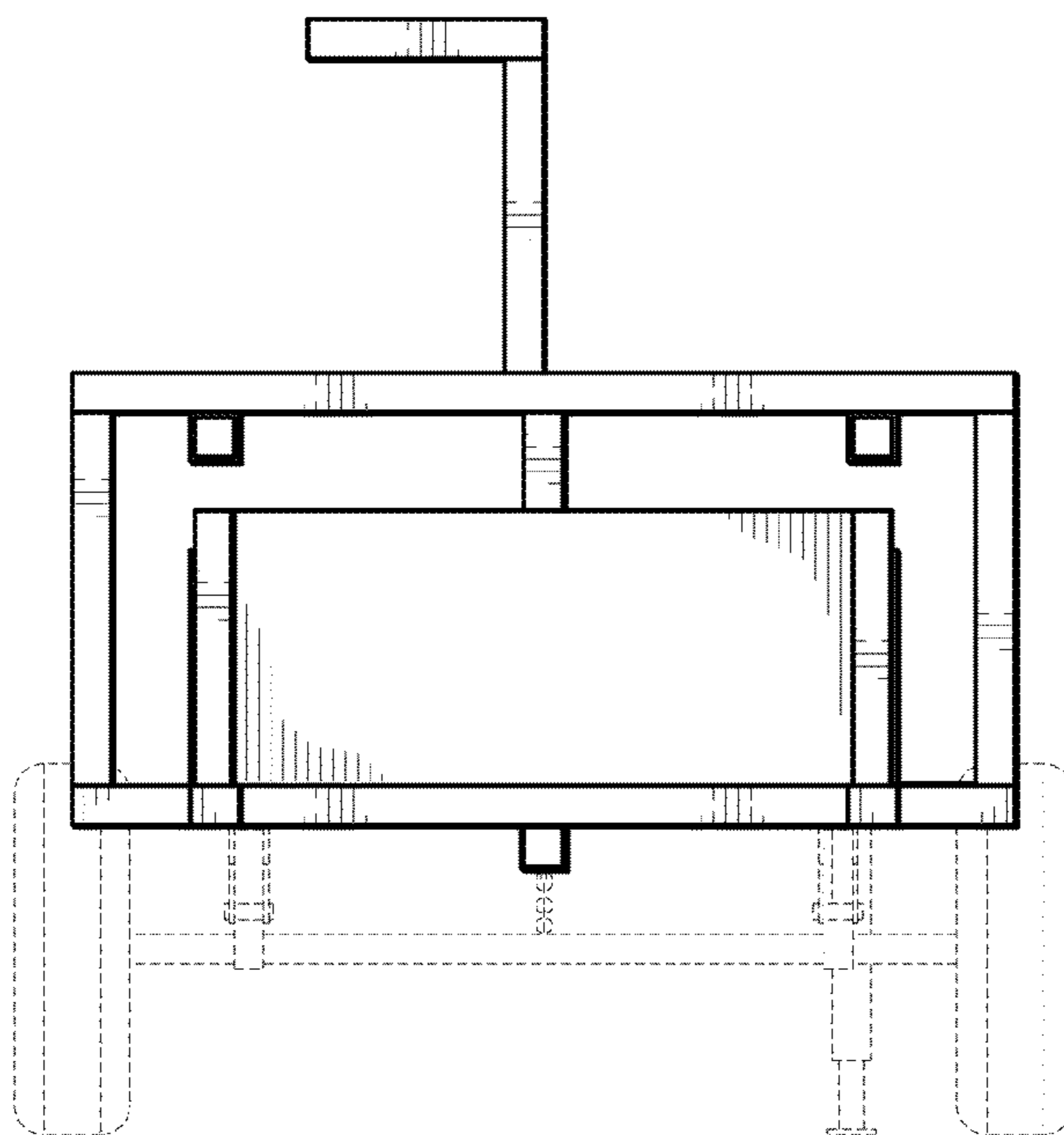

FIG. 3

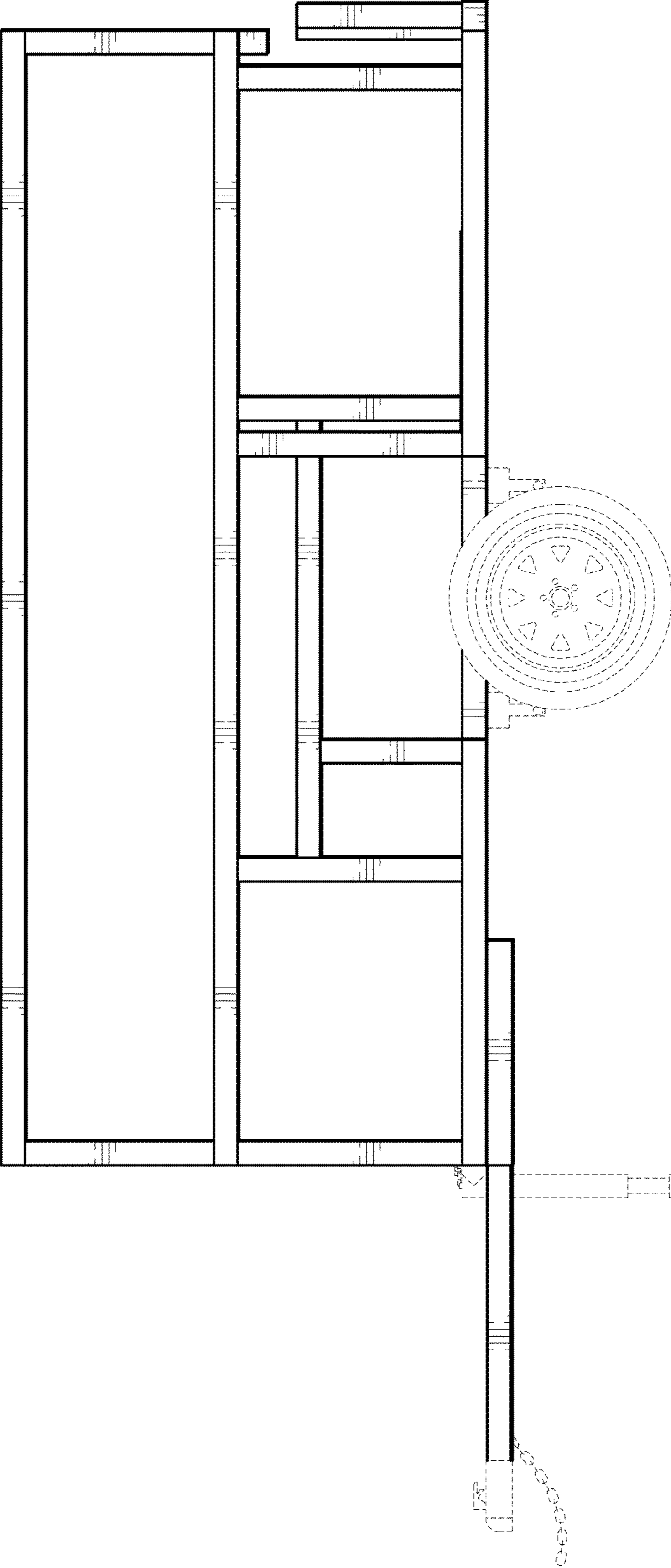

FIG. 4

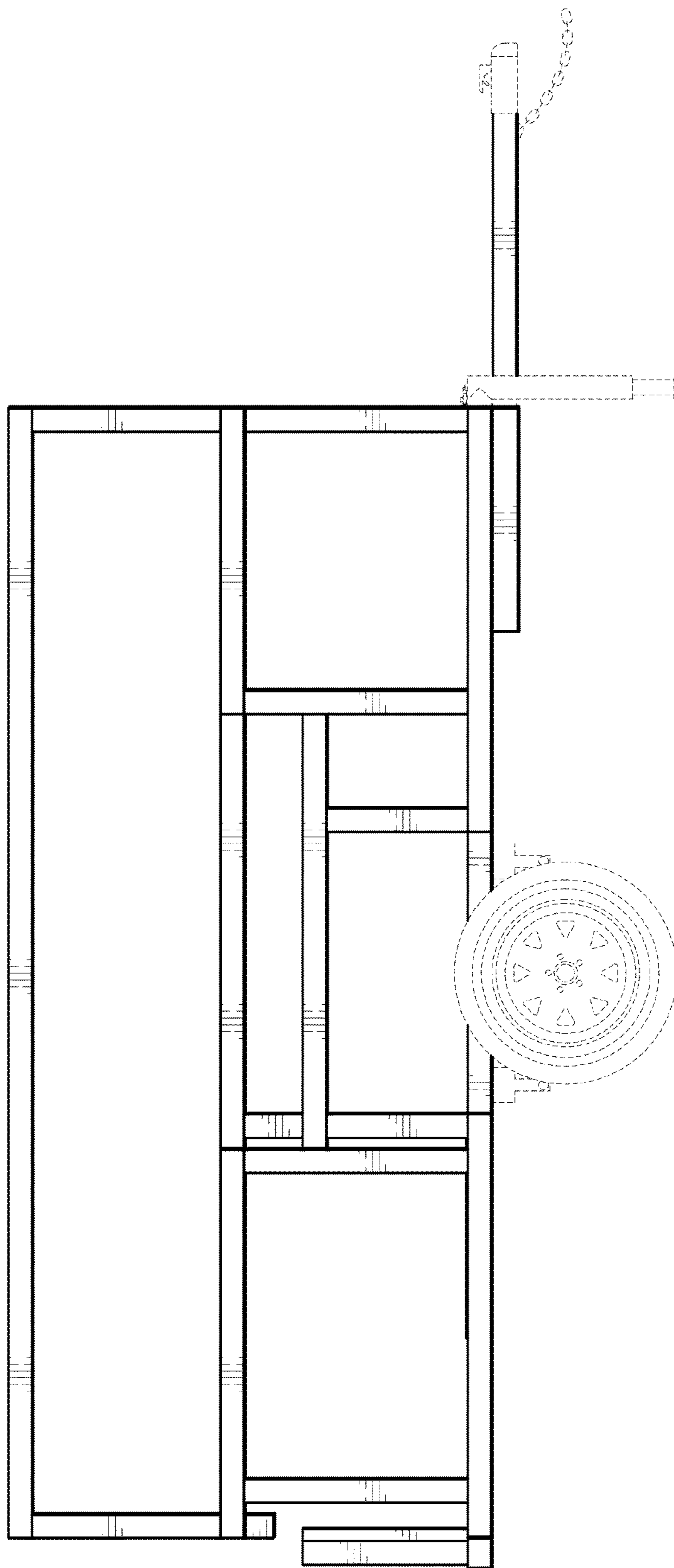

FIG. 5

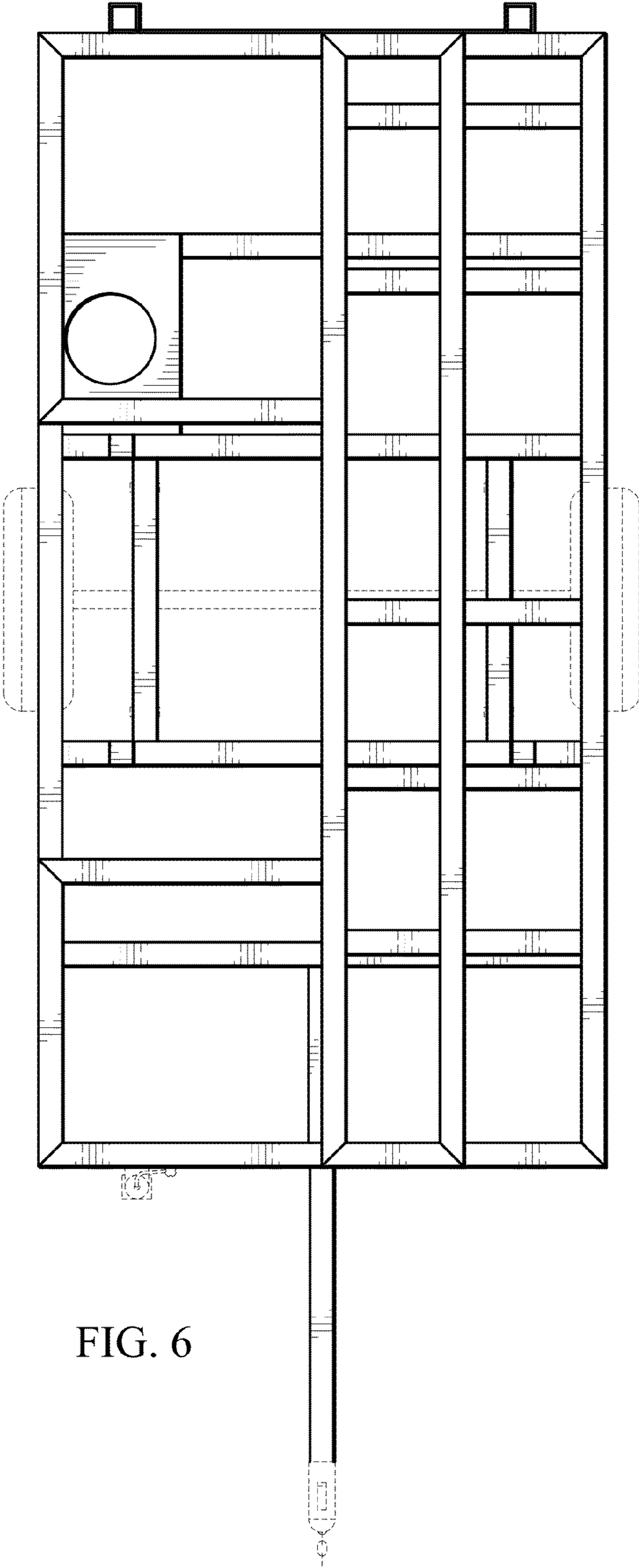
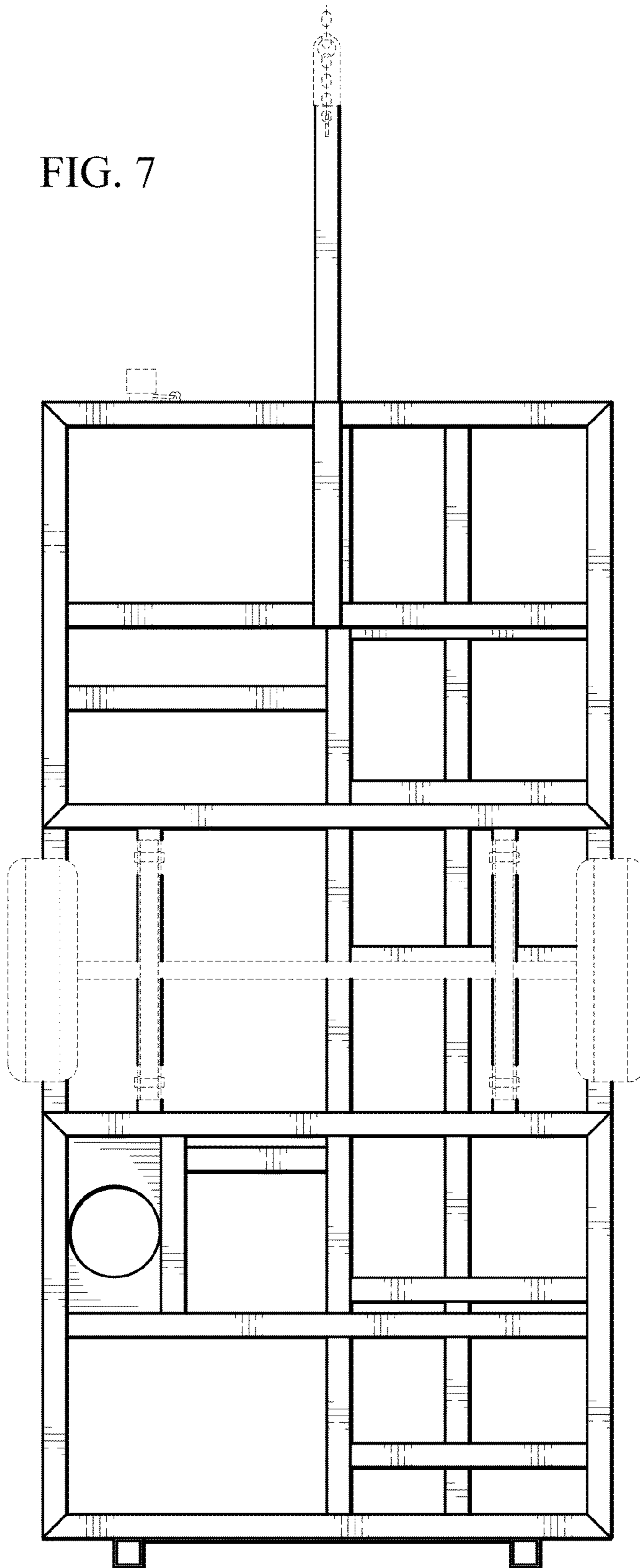

FIG. 6

FIG. 7



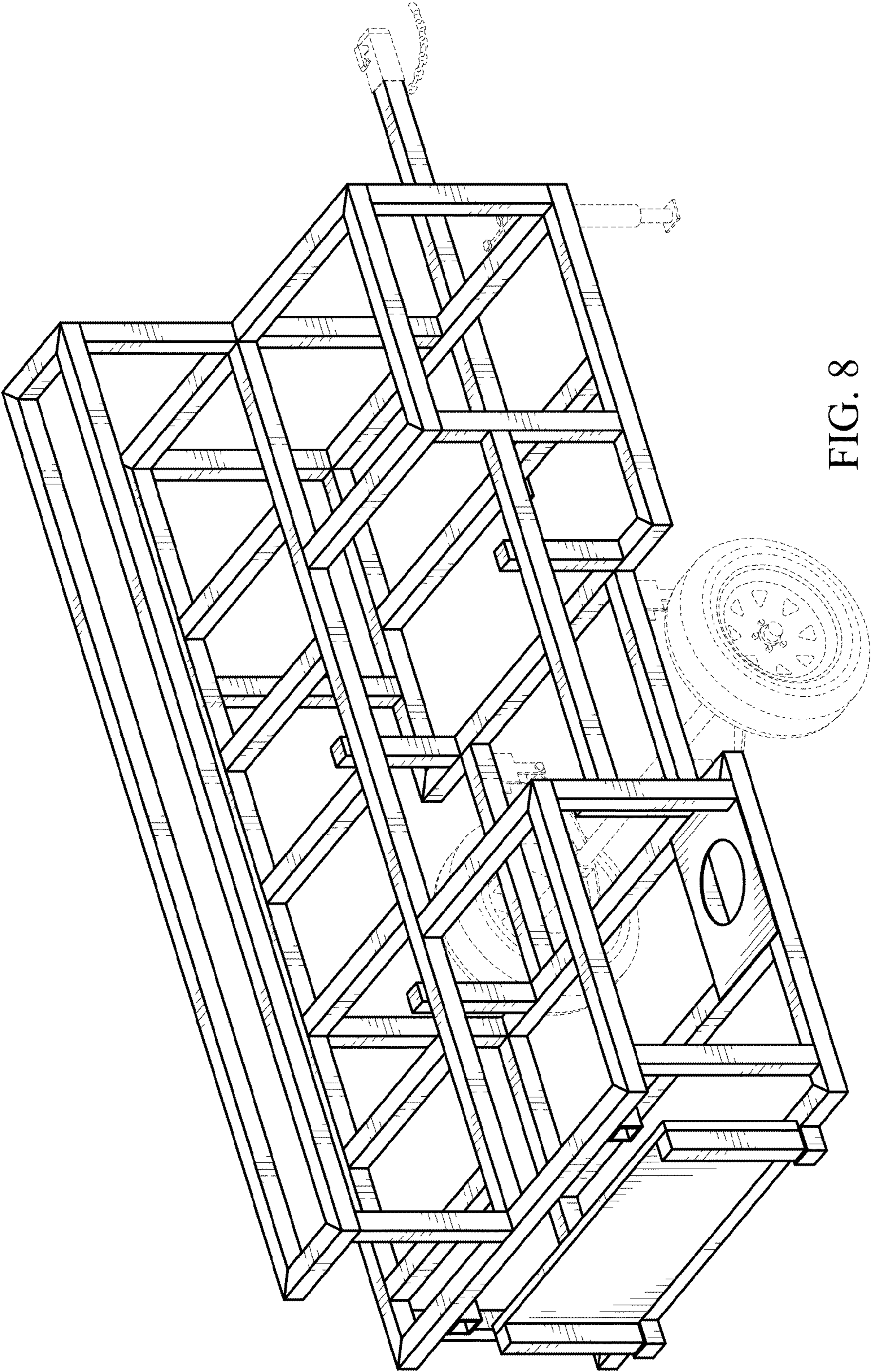

FIG. 8

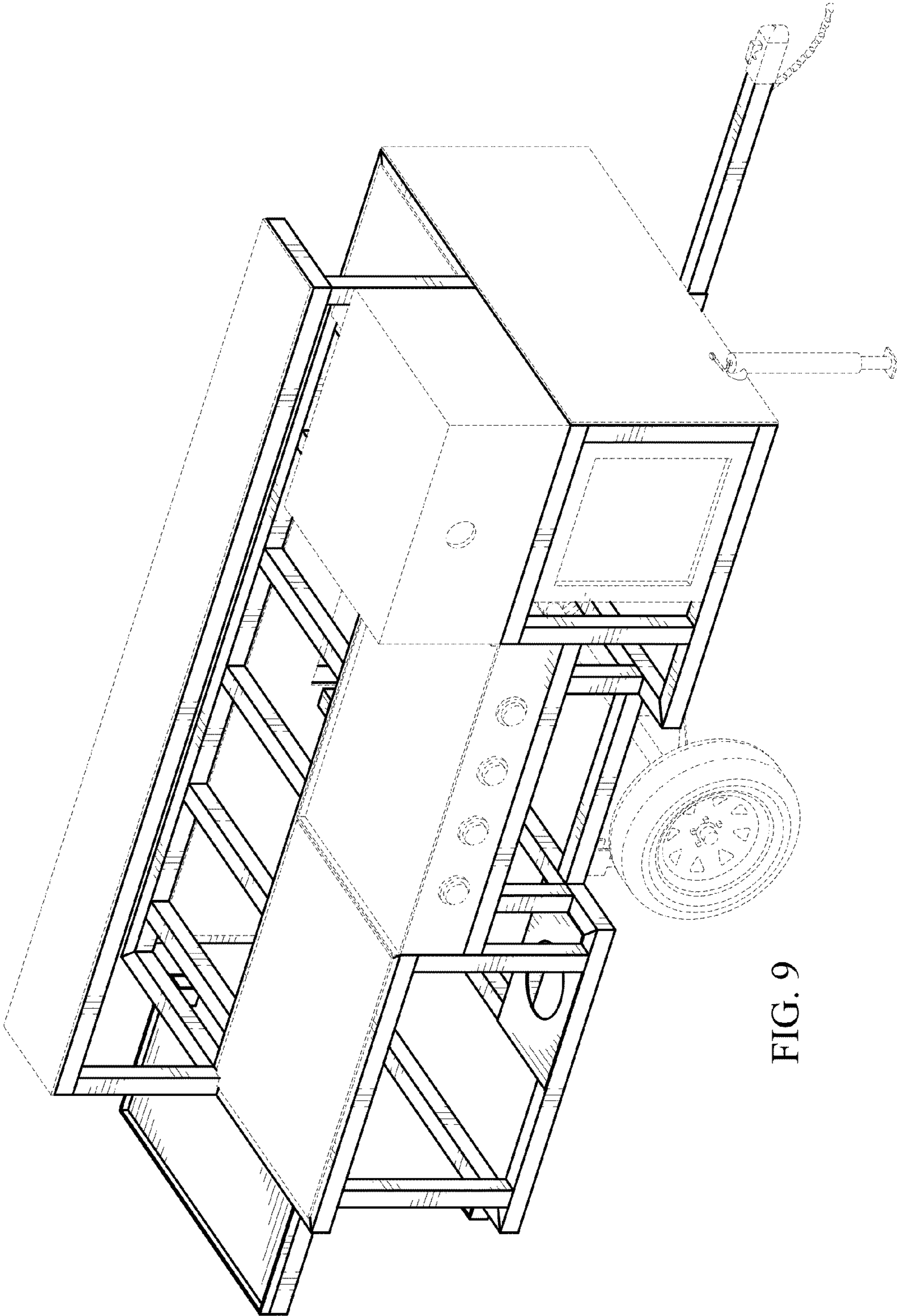

FIG. 9

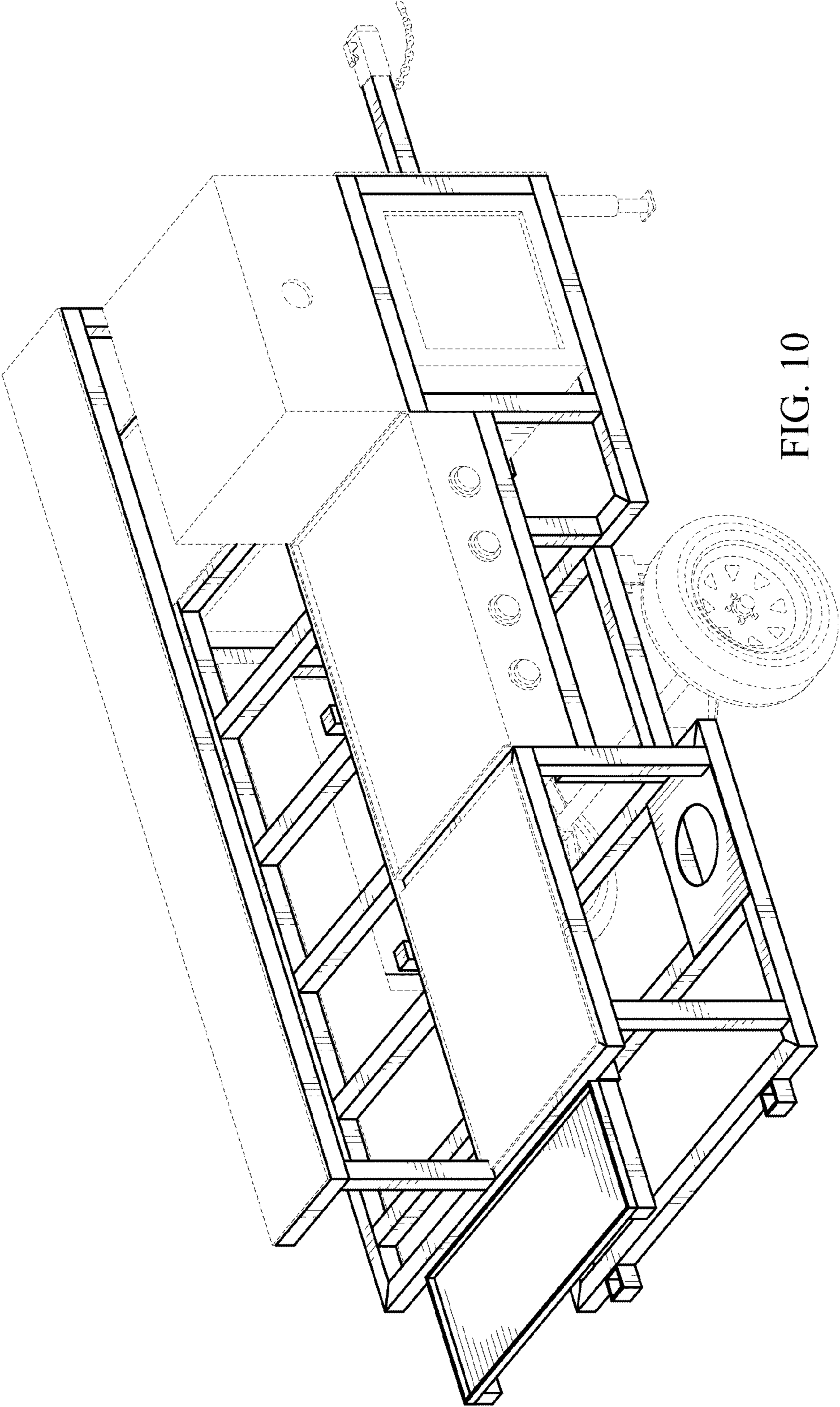

FIG. 10