



US00D733002S

(12) **United States Design Patent**
Loeb

(10) **Patent No.:** **US D733,002 S**
(45) **Date of Patent:** **** Jun. 30, 2015**

(54) **MOTOR CAR**
(71) Applicant: **GM Global Technology Operations LLC, Detroit, MI (US)**
(72) Inventor: **Niels Loeb, Wiesbaden (DE)**
(73) Assignee: **GM Global Technology Operations LLC, Detroit, MI (US)**
(**) Term: **14 Years**

D605,083 S 12/2009 Manoogian, II et al.
D605,977 S 12/2009 Zipfel et al.
D605,978 S 12/2009 Wolff et al.
D608,249 S 1/2010 Peters
D608,690 S 1/2010 Folden et al.
D608,691 S 1/2010 Zak, Jr. et al.
D609,608 S 2/2010 Boniface et al.
D611,387 S 3/2010 Thompson et al.
D611,879 S 3/2010 Kim et al.
D612,297 S 3/2010 Peters et al.
D613,645 S 4/2010 Song et al.
D615,458 S 5/2010 Thompson et al.

(Continued)

(21) Appl. No.: **29/499,829**

OTHER PUBLICATIONS

(22) Filed: **Aug. 19, 2014**

Design U.S. Appl. No. 29/439,307, filed Dec. 10, 2012; First Named Inventor: Brendon C. Mackay; Title: Vehicle Body Exterior.

(30) **Foreign Application Priority Data**

(Continued)

Feb. 20, 2014 (EM) 002 408 880

(51) **LOC (10) Cl.** **12-08**

(52) **U.S. Cl.**
USPC **D12/90**

(58) **Field of Classification Search**
USPC D12/86, 90-92; D21/421, 433, 434;
296/181.1, 181.5

CPC B62D 35/00; B62D 25/00; B62D 25/06;
B62D 25/08; B62D 33/00

See application file for complete search history.

Primary Examiner — Melody N Brown

(74) *Attorney, Agent, or Firm* — Reising Ethington P.C.

(57) **CLAIM**

The ornamental design for a motor car, as shown and described.

DESCRIPTION

FIG. 1 is a front and left side perspective view of the motor car;

FIG. 2 is a rear and right side perspective view thereof;

FIG. 3 is a left side elevation view thereof;

FIG. 4 is a right side elevation view thereof;

FIG. 5 is a front elevation view thereof;

FIG. 6 is a rear elevation view thereof; and,

FIG. 7 is a top plan view thereof.

The broken lines shown in the drawings depict portions of the motor car that form no part of the claimed design.

(56) **References Cited**

U.S. PATENT DOCUMENTS

D570,742 S 6/2008 Takagi et al.
D592,105 S 5/2009 Dean et al.
D597,447 S 8/2009 Folden
D600,595 S 9/2009 Nakamura et al.
D601,925 S 10/2009 O'Donnell
D603,755 S 11/2009 Peters
D604,203 S 11/2009 O'Donnell
D605,082 S 12/2009 Munson

1 Claim, 6 Drawing Sheets

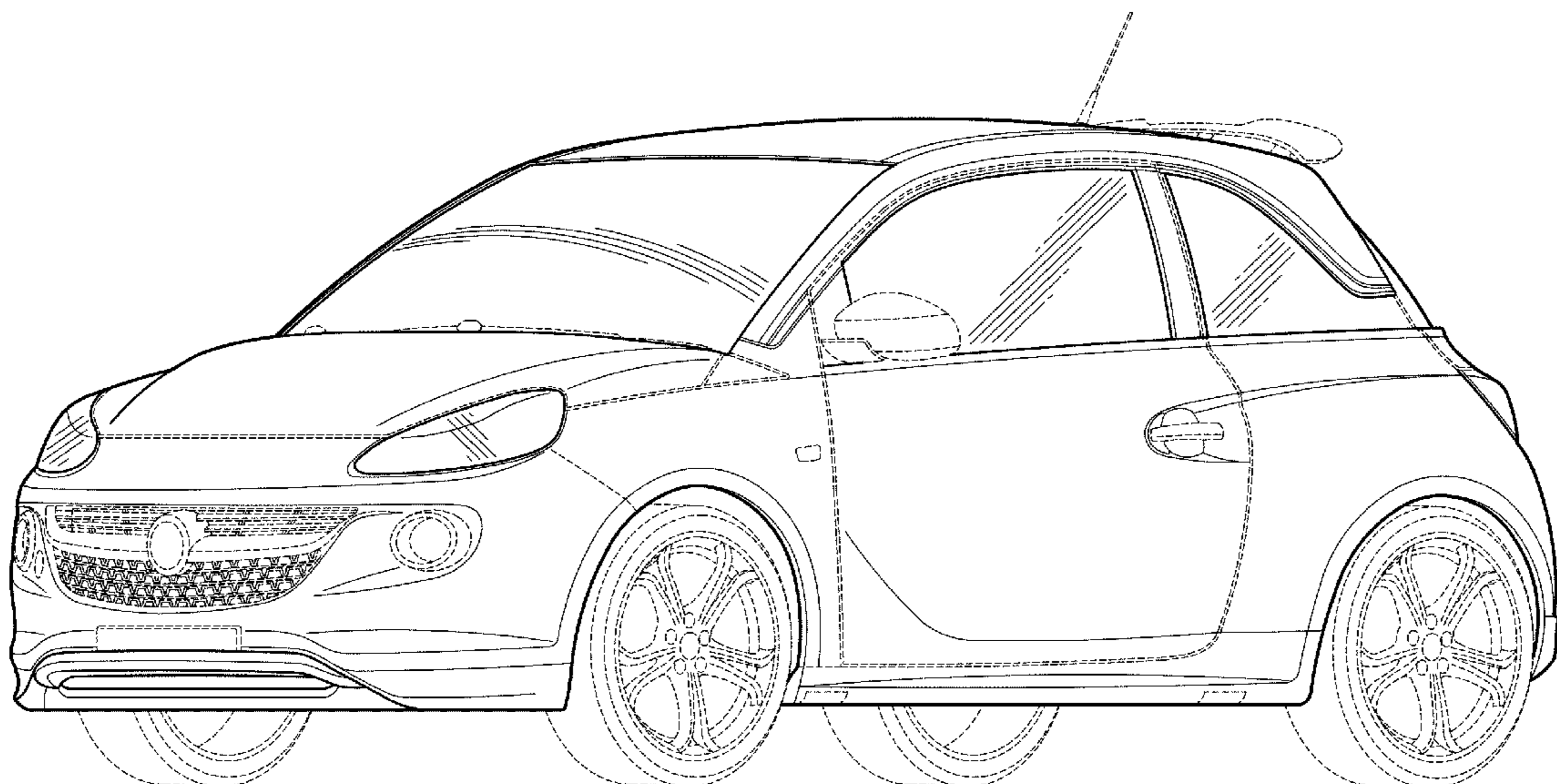

(56)

References Cited

U.S. PATENT DOCUMENTS

D618,595 S 6/2010 Ware et al.
 D623,090 S 9/2010 Cox et al.
 D627,262 S 11/2010 Ikeda et al.
 D635,488 S 4/2011 Phipps
 D644,147 S 8/2011 Suh et al.
 D644,567 S 9/2011 Kozub
 D657,718 S 4/2012 Zipfel et al.
 D659,052 S 5/2012 Ware et al.
 D659,053 S 5/2012 Ware et al.
 D668,182 S 10/2012 Barba Franco
 D668,183 S 10/2012 Smart
 D678,819 S * 3/2013 Akamine et al. D12/90
 D678,820 S 3/2013 Song et al.
 D678,821 S 3/2013 Ikeda et al.
 D680,909 S 4/2013 Munson et al.
 D680,910 S 4/2013 David
 D684,899 S 6/2013 Baker
 D686,536 S 7/2013 McCabe et al.
 D688,160 S * 8/2013 Akamine et al. D12/90
 D692,798 S 11/2013 Thurber
 D692,799 S 11/2013 Smith et al.
 D693,271 S * 11/2013 Burki et al. D12/90
 D696,157 S 12/2013 Loeb
 D699,629 S 2/2014 Ikeda et al.
 D700,104 S * 2/2014 Malachowski D12/90
 D700,871 S 3/2014 O'Donnell et al.
 D703,103 S 4/2014 Lee
 D704,103 S 5/2014 Mack et al.
 D705,132 S 5/2014 Ware et al.
 D705,699 S 5/2014 Ware et al.
 D720,256 S * 12/2014 Palma et al. D12/91

OTHER PUBLICATIONS

Design U.S. Appl. No. 29/450,700, filed Mar. 21, 2013; First Named Inventor: Andrew Dyson; Title: Motor Car.
 Design U.S. Appl. No. 29/451,178, filed Mar. 28, 2013; First Named Inventor: Richard Fulvio Ferlazzo; Title: Vehicle Body Exterior.
 Design U.S. Appl. No. 29/466,855, filed Sep. 12, 2013; First Named Inventor: Louis Thole; Title: Vehicle Body Exterior.
 Design U.S. Appl. No. 29/466,859, filed Sep. 12, 2013; First Named Inventor: Louis Thole; Title: Vehicle Body Exterior.
 Design U.S. Appl. No. 29/471,417, filed Oct. 31, 2013; First Named Inventor: Robin Krieg; Title: Vehicle Body Exterior.
 Design U.S. Appl. No. 29/476,490, filed Dec. 13, 2013; First Named Inventor: Robert J. Munson; Title: Vehicle Body Exterior.
 Design U.S. Appl. No. 29/475,782, filed Dec. 6, 2013; First Named Inventor: Niels Loeb; Title: Motor Car.
 Design U.S. Appl. No. 29/475,785, filed Dec. 6, 2013; First Named Inventor: Niels Loeb; Title: Motor Car.
 Design U.S. Appl. No. 29/477,931, filed Dec. 30, 2013; First Named Inventor: Louis D. Thole; Title: Vehicle Body Exterior.
 Design U.S. Appl. No. 29/478,287, filed Jan. 3, 2014; First Named Inventor: Boris Jacob; Title: Motor Car.
 Design U.S. Appl. No. 29/478,501, filed Jan. 6, 2014; First Named Inventor: Robert B. McMahan; Title: Vehicle Body Exterior.
 Design U.S. Appl. No. 29/487,899, filed Apr. 14, 2014; First Named Inventor: Carsten Aengenheyster; Title: Motor Car.
 Design U.S. Appl. No. 29/491,286, filed May 20, 2014; First Named Inventor: Robert B. McMahan; Title: Vehicle Body Exterior.
 Design U.S. Appl. No. 29/492,639, filed Jun. 2, 2014; First Named Inventor: Jeasoo Kim; Title: Vehicle Body Exterior.
 Design U.S. Appl. No. 29/498,301, filed Aug. 1, 2014; First Named Inventor: Niki J. Smart Title: Vehicle Body Exterior.

* cited by examiner

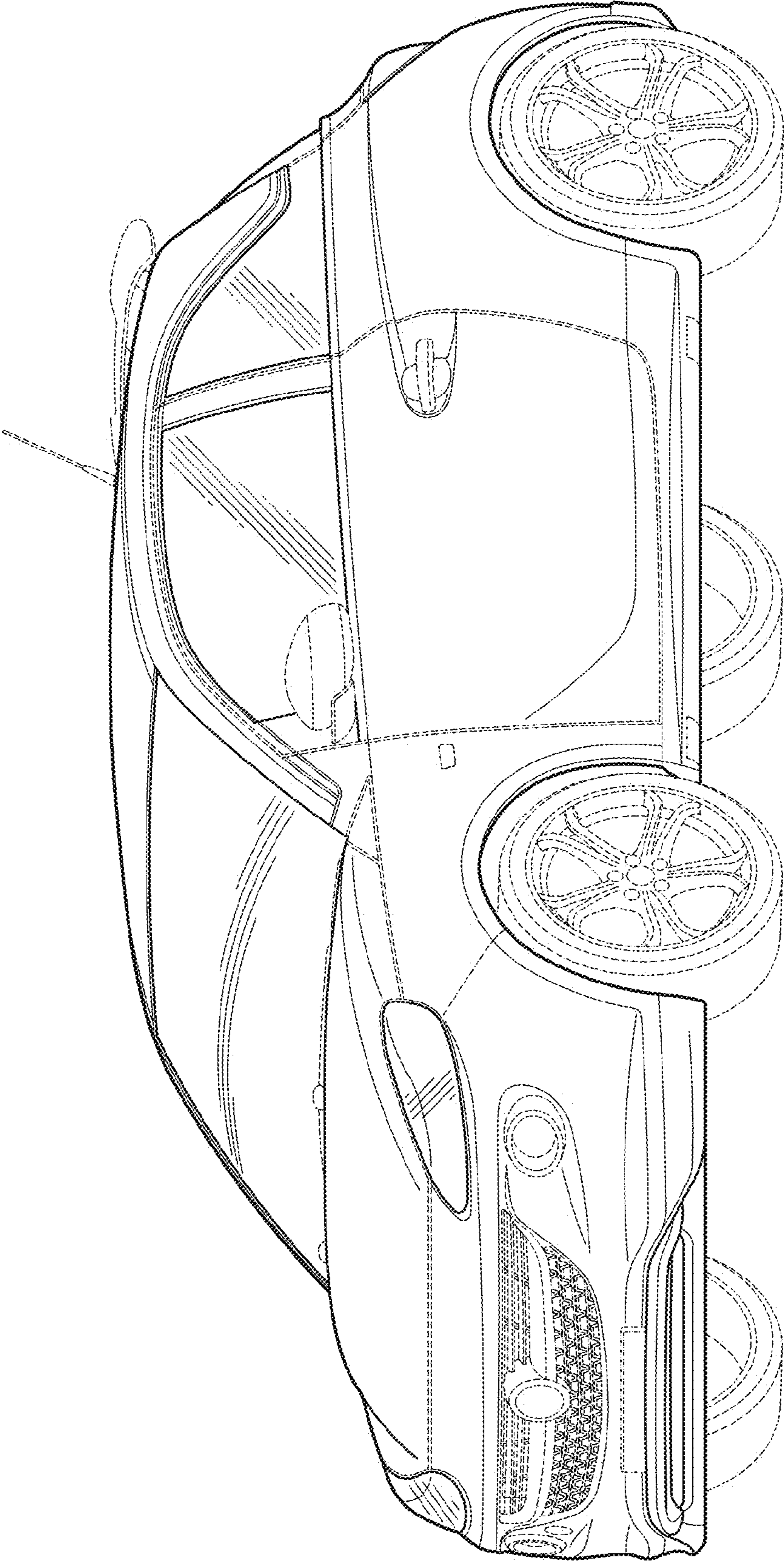

FIG. 1

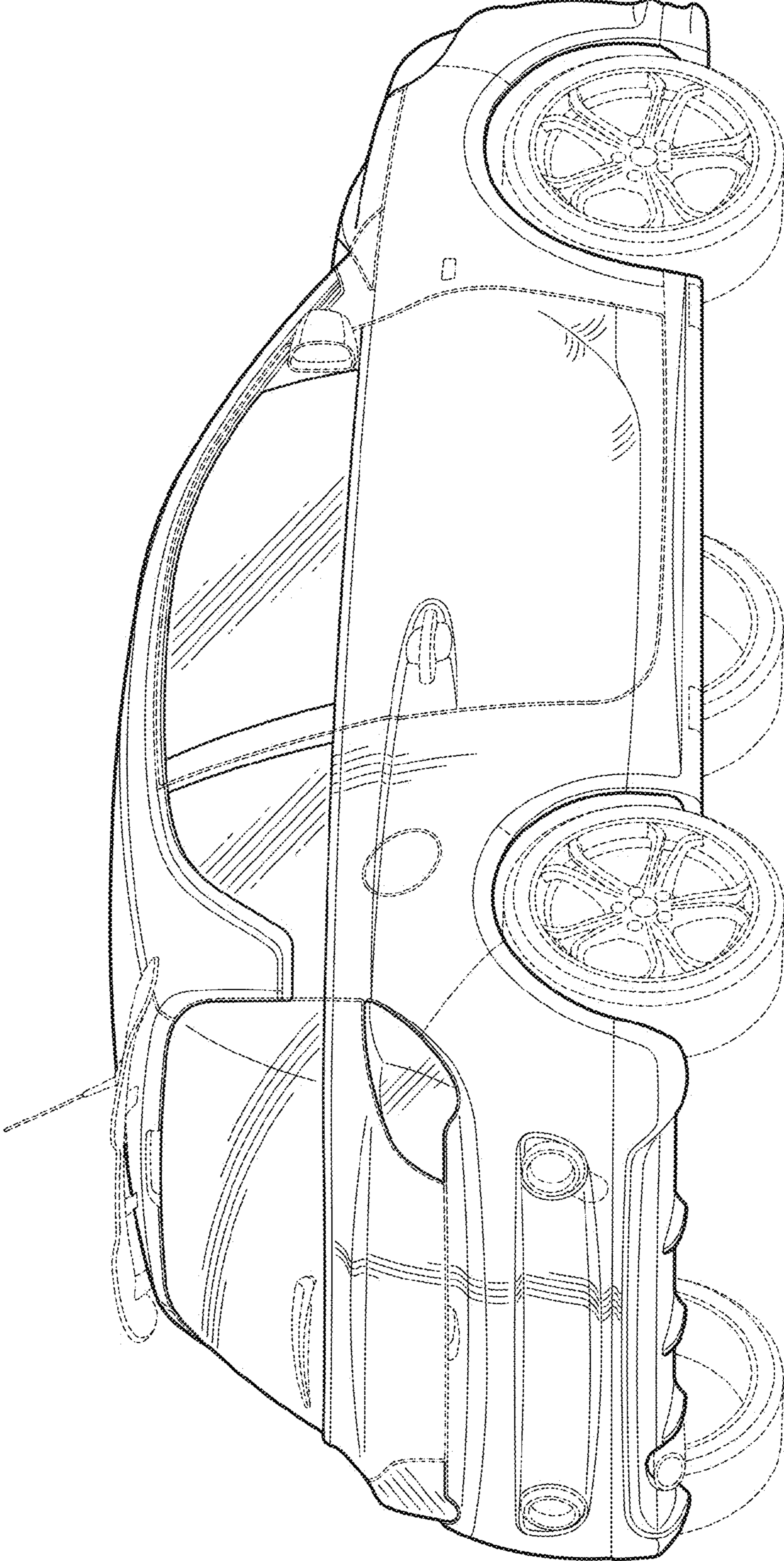

FIG. 2

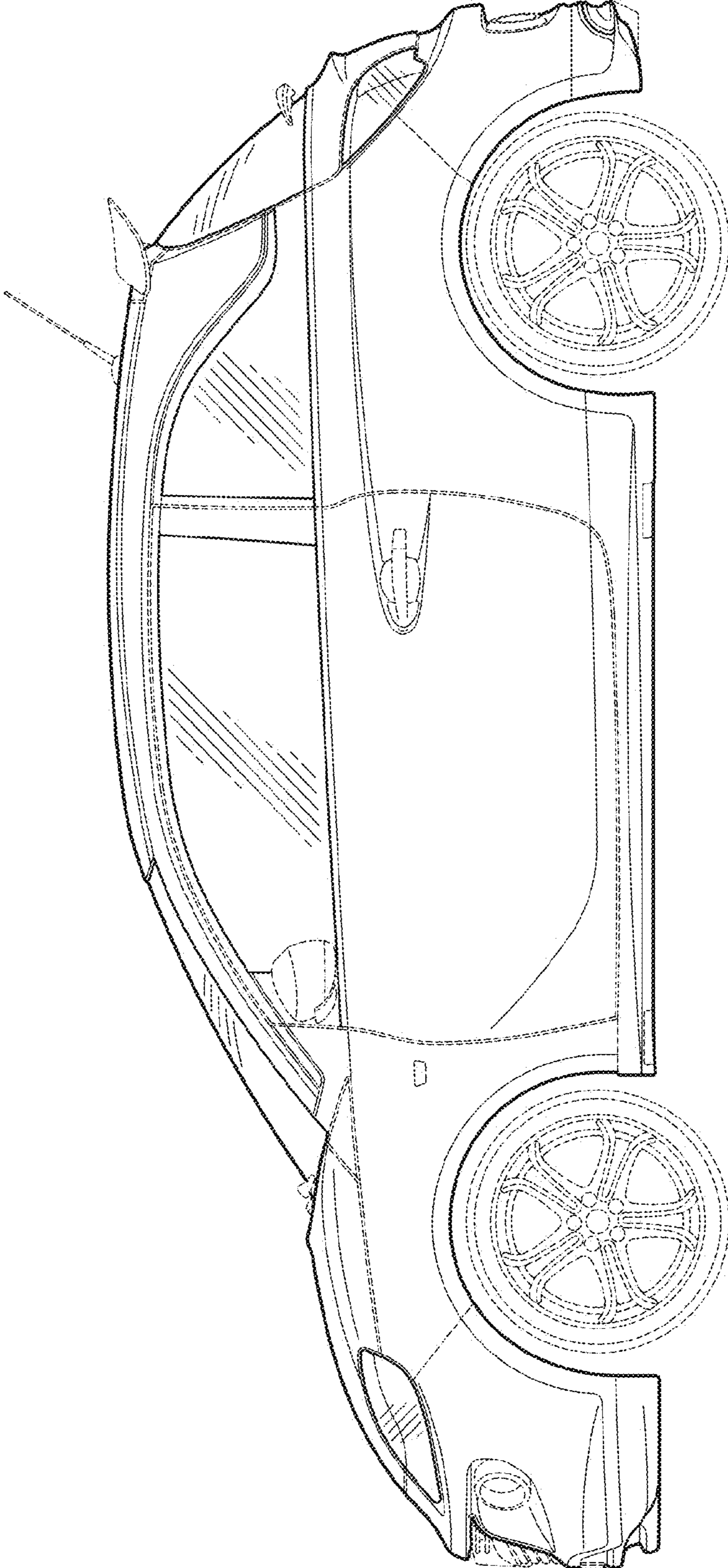

FIG. 3

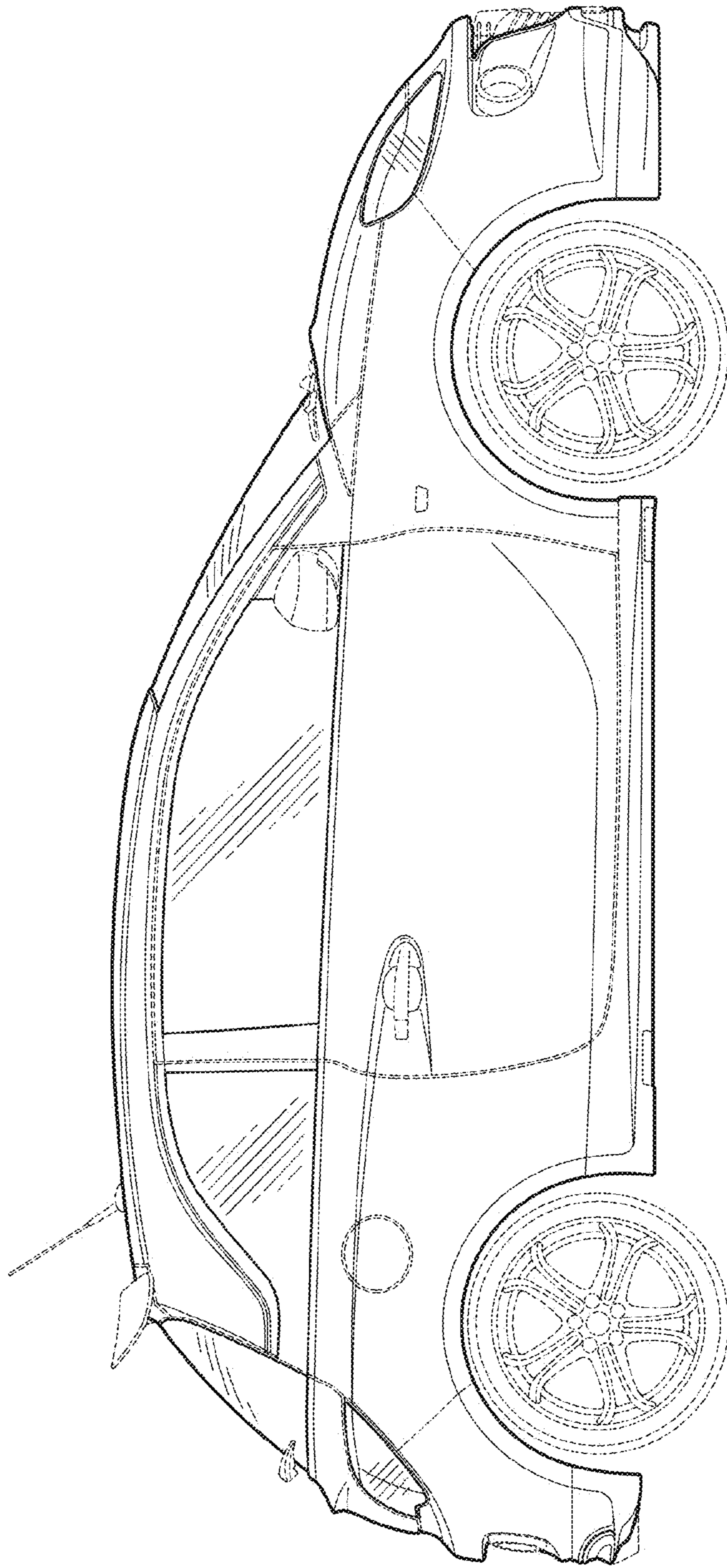

FIG. 4

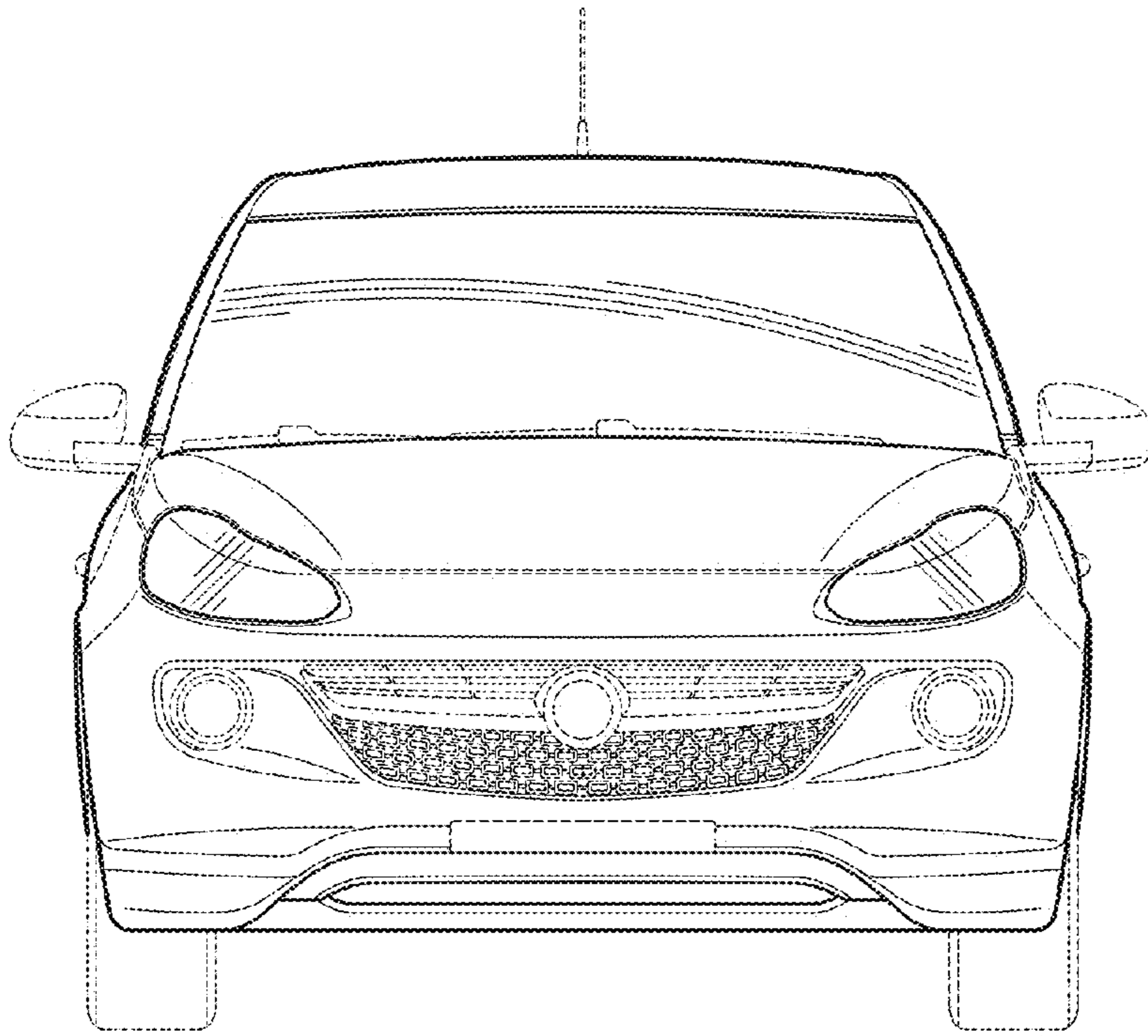

FIG. 5

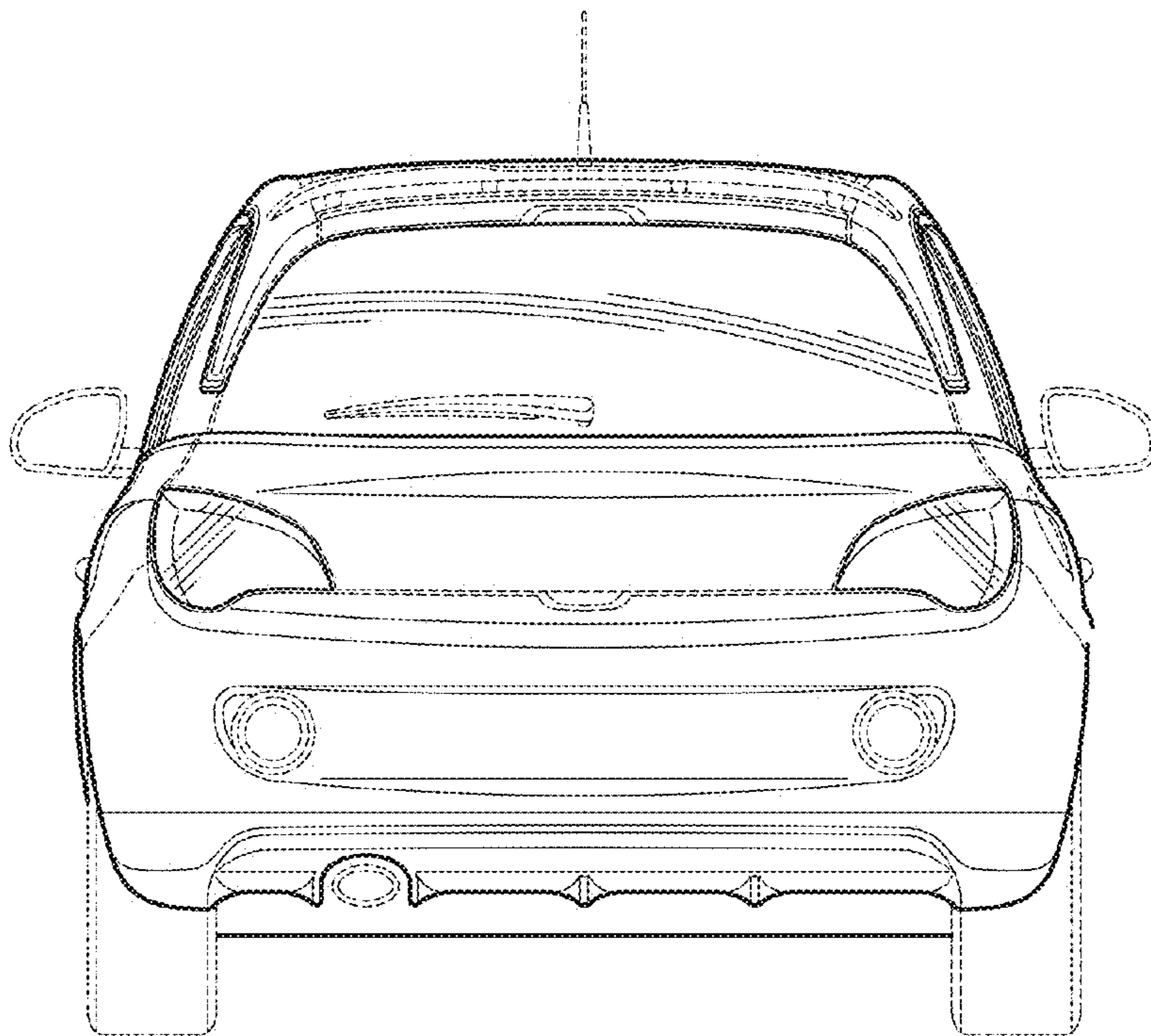

FIG. 6

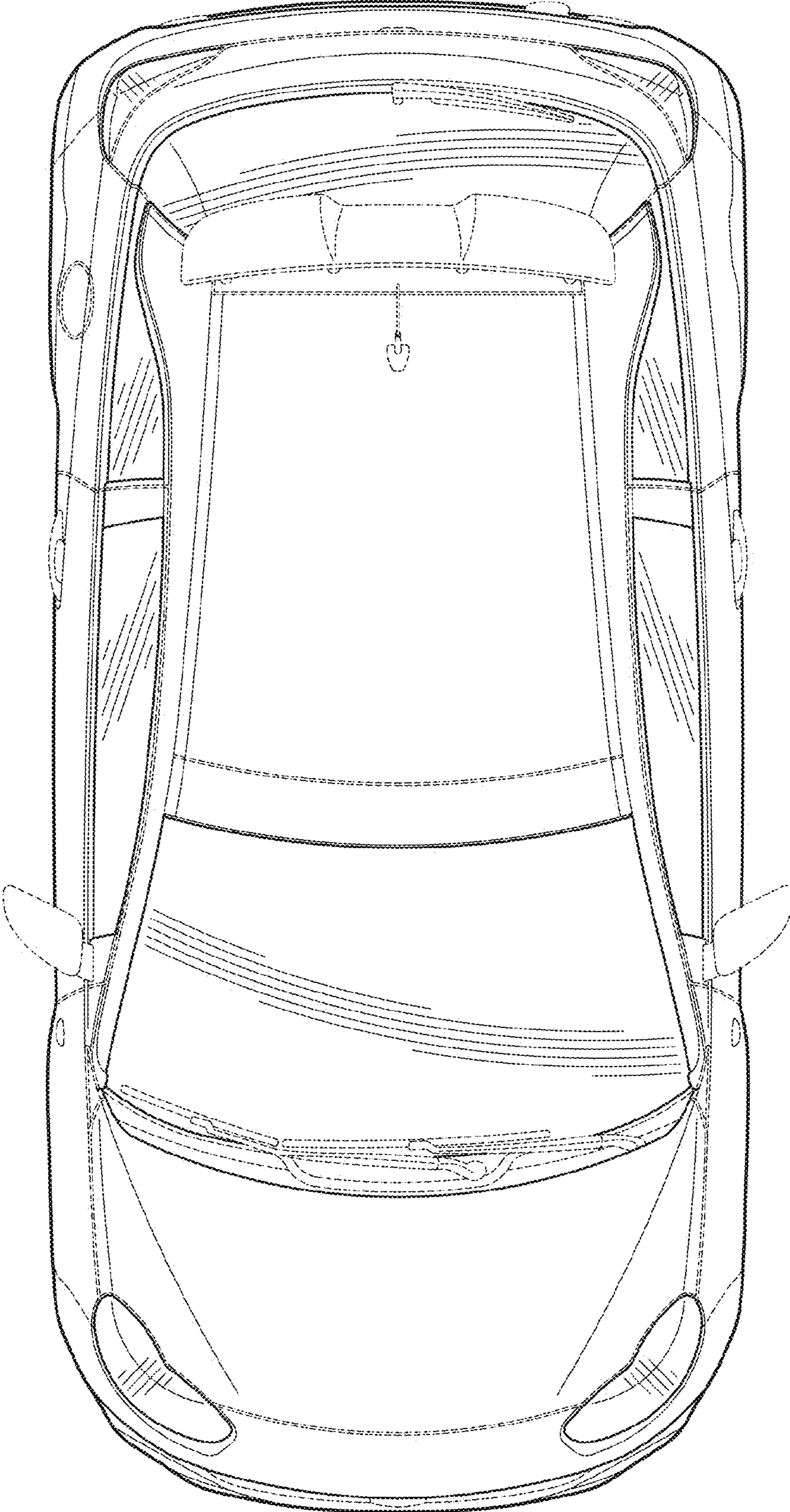

FIG. 7