



US00D732969S

(12) **United States Design Patent**
Berard

(10) **Patent No.:** **US D732,969 S**
(45) **Date of Patent:** **** Jun. 30, 2015**

(54) **BOTTLE**

(75) Inventor: **Jerome Berard**, New York, NY (US)

(73) Assignee: **Express, LLC**, Columbus, OH (US)

(**) Term: **14 Years**

(21) Appl. No.: **29/429,179**

(22) Filed: **Aug. 8, 2012**

(51) **LOC (10) Cl.** **09-01**

(52) **U.S. Cl.**

USPC **D9/559**; D9/565; D9/573

(58) **Field of Classification Search**

USPC D9/682, 687, 694, 516, 529-530, 538,
D9/541, 546, 552, 556, 559, 560, 565, 569,
D9/573-575, 449; 215/382-384; 220/660,
220/669, 675

See application file for complete search history.

(56) **References Cited**

U.S. PATENT DOCUMENTS

D54,219 S *	11/1919	McCoy	D9/546
D168,932 S *	3/1953	Frydlender	D9/529
D279,511 S *	7/1985	Matsubara et al.	D9/559 X
D318,618 S *	7/1991	Scarpa et al.	D9/559
D380,356 S *	7/1997	Husted	D9/552 X
D411,458 S *	6/1999	de Baschmakoff	D9/572 X
D475,285 S *	6/2003	Bomer	D9/559
D502,104 S *	2/2005	Schmedes	D9/575 X
D502,874 S *	3/2005	Schmedes	D9/575 X
D542,136 S *	5/2007	Lilico	D9/559 X
D544,361 S *	6/2007	Cordes	D9/565 X
D548,095 S *	8/2007	McGuinness	D9/573 X

D549,587 S *	8/2007	Lestelle	D9/560
D564,708 S *	3/2008	Kuo	D9/529 X
D566,573 S *	4/2008	Lestelle	D9/560
D583,247 S *	12/2008	DeFina	D9/546
D584,638 S *	1/2009	Castelnuovo-Tedesco	D9/686
D599,672 S *	9/2009	Carlson et al.	D9/565 X
D605,948 S *	12/2009	Sposato	D9/546
D638,474 S *	5/2011	Yang et al.	D19/73
D650,690 S *	12/2011	Guglielmo et al.	D9/559
D675,535 S *	2/2013	Nomura et al.	D9/538 X
D689,773 S *	9/2013	Nomura et al.	D9/538
D709,330 S *	7/2014	Holmes	D9/552 X
2007/0068894 A1 *	3/2007	Iwashita et al.	215/382

* cited by examiner

Primary Examiner — Carol P Rademaker

(74) *Attorney, Agent, or Firm* — Mark J. Nahnsen; Barnes & Thornburg LLP

(57) **CLAIM**

The ornamental design for a bottle, as shown and described.

DESCRIPTION

FIG. 1 is a top, front isometric view of a bottle;

FIG. 2 is a rear elevational view thereof;

FIG. 3 is a front elevational view thereof;

FIG. 4 is left side view thereof;

FIG. 5 is right side view thereof;

FIG. 6 is a top plan view thereof; and,

FIG. 7 is a bottom plan view thereof.

The broken lines shown in the drawing views are included for the purpose of illustrating environmental structure and form no part of the claimed design.

1 Claim, 4 Drawing Sheets

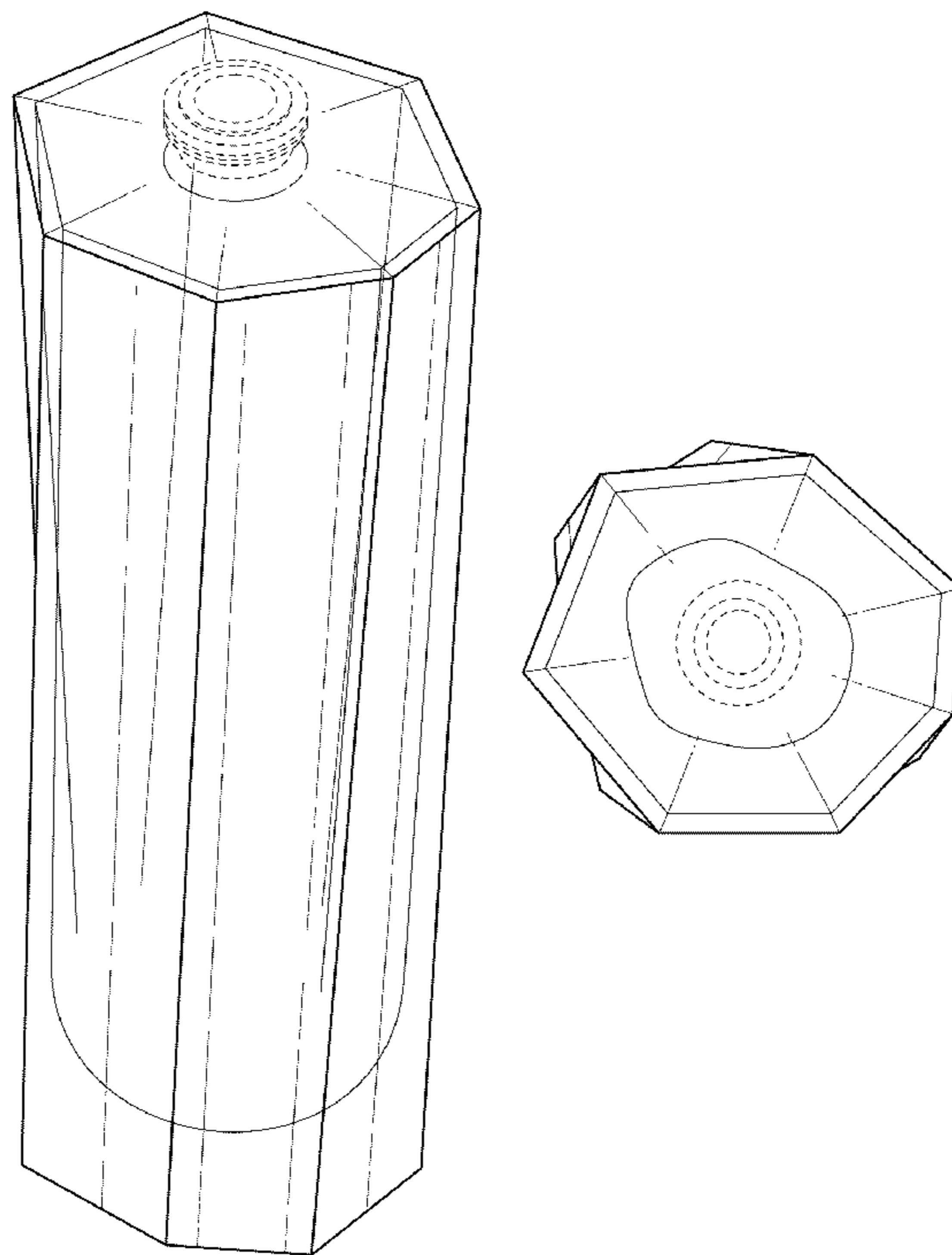

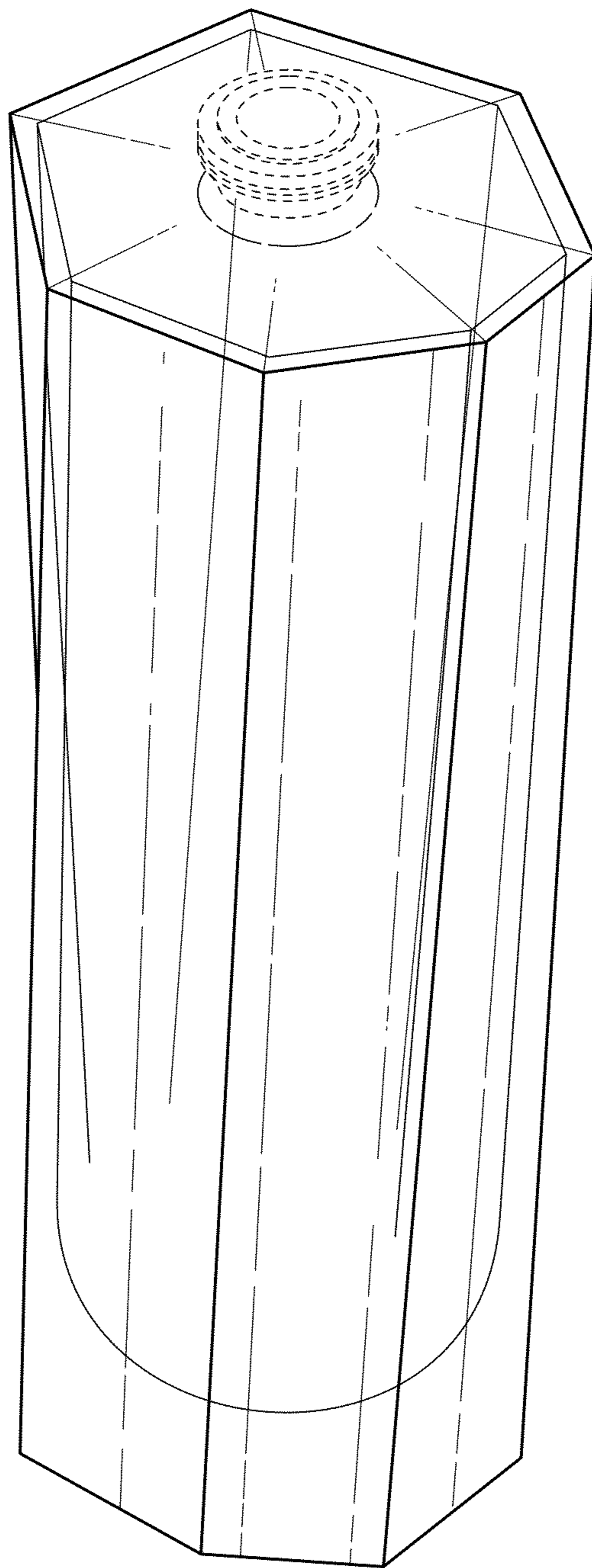

FIG. 1

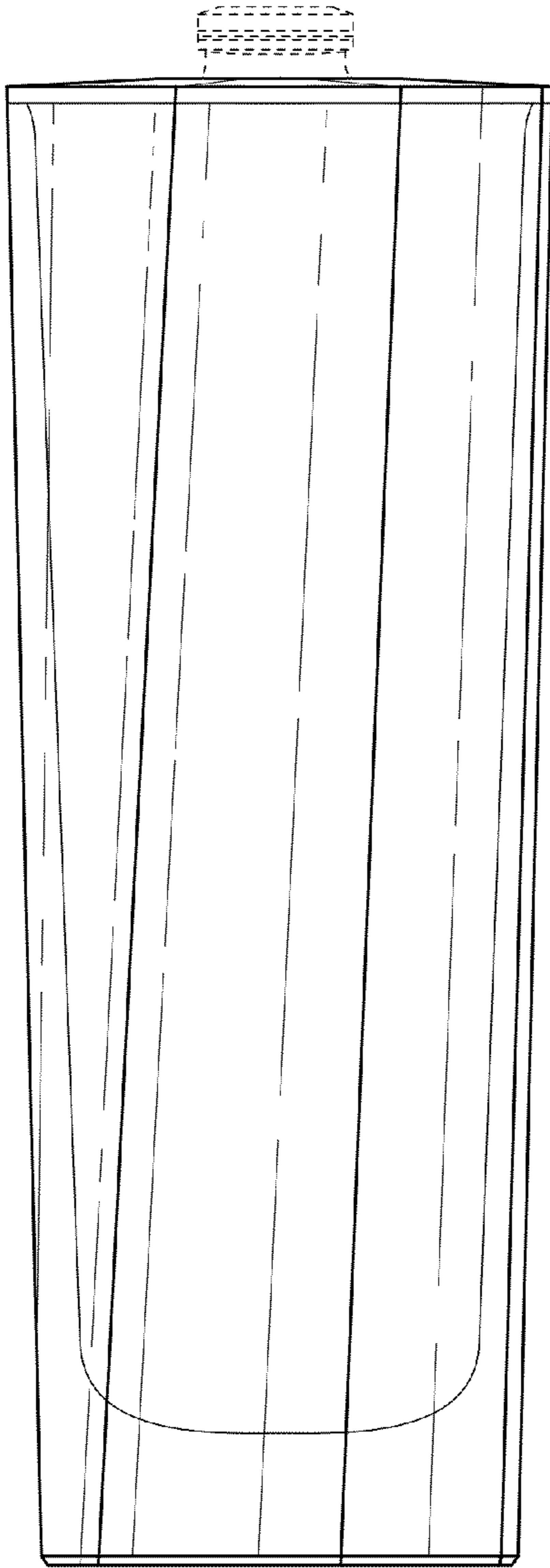

FIG. 2

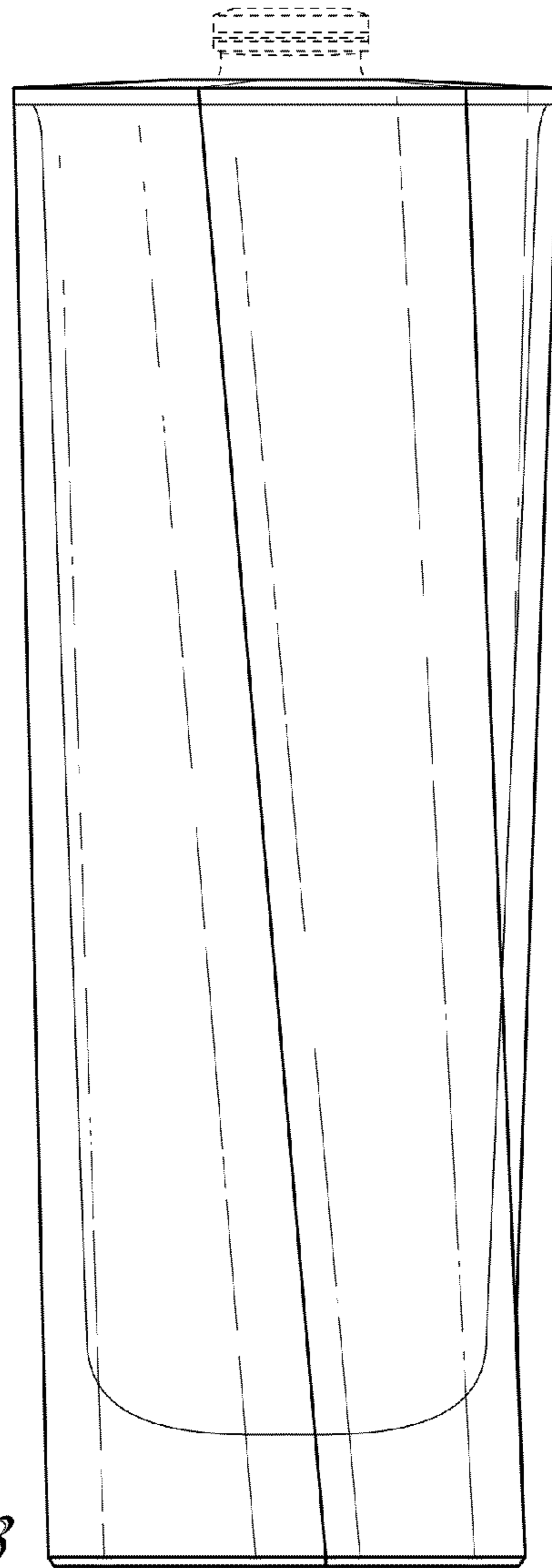

FIG. 3

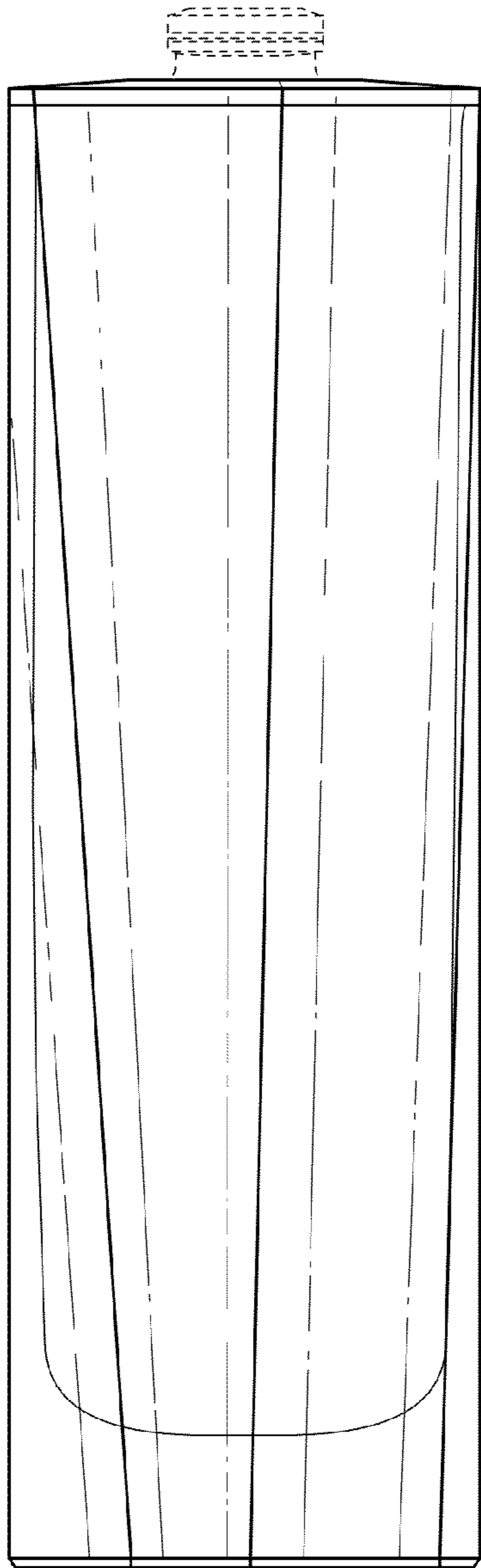

FIG. 4

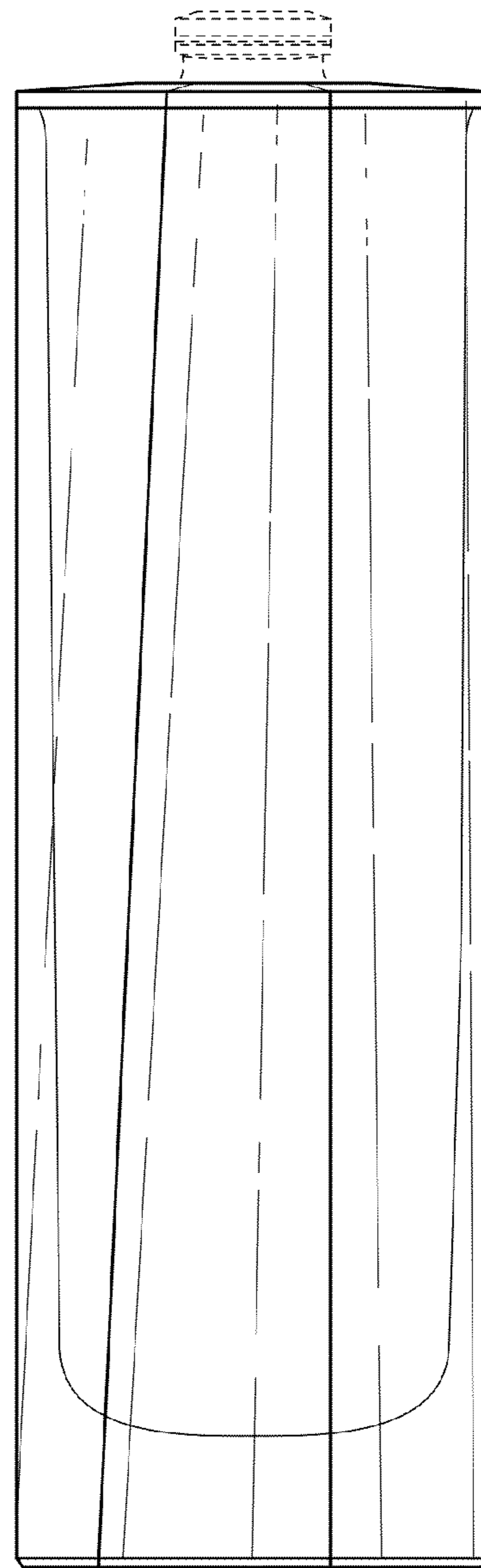

FIG. 5

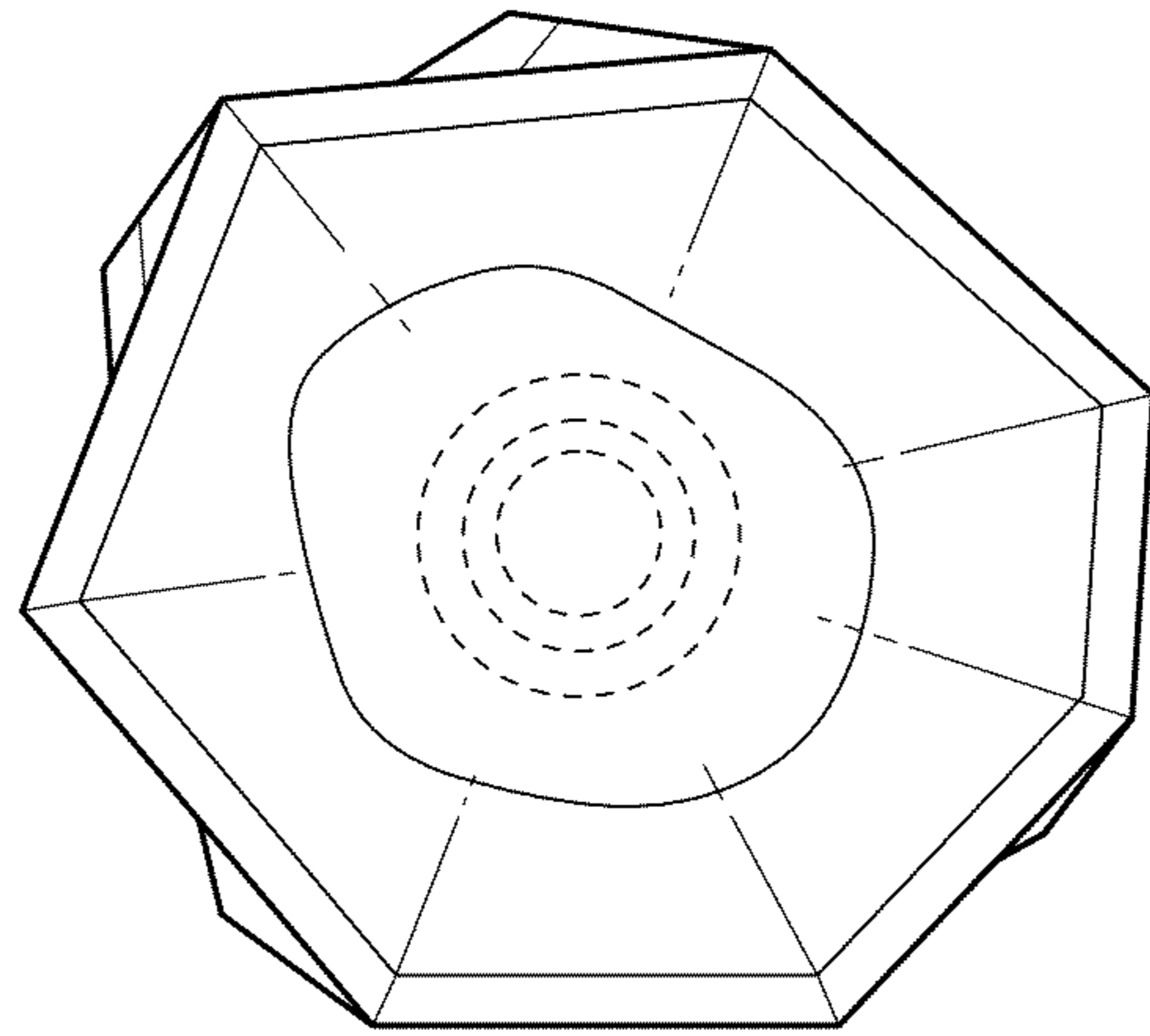

FIG. 6

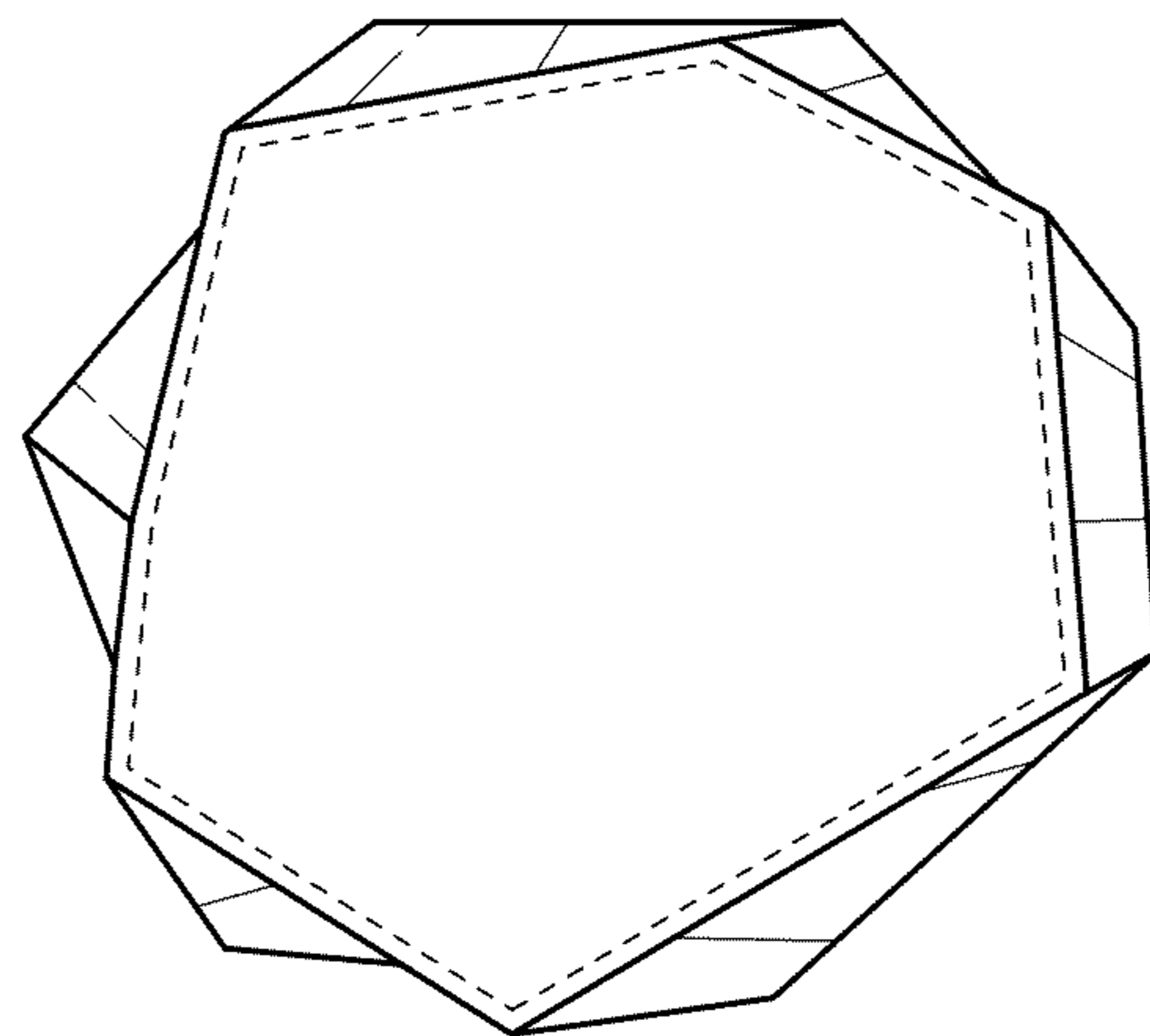

FIG. 7