



US00D732942S

(12) **United States Design Patent**  
**Baur et al.**

(10) **Patent No.:** **US D732,942 S**  
(45) **Date of Patent:** **\*\* Jun. 30, 2015**

(54) **CONNECTING ASSEMBLY INCLUDING A MALE PORTION AND A FEMALE PORTION**

(71) Applicants: **Lamello AG**, Bubendorf (CH); **Franz Baur**, Oberstaufen (DE); **Franz Haser**, Oberstaufen (DE)

(72) Inventors: **Franz Baur**, Oberstaufen (DE); **Franz Haser**, Oberstaufen (DE); **Philipp Seiler**, Arboldswil (CH); **Patrick Jeker**, Brislach (CH)

(73) Assignees: **Franz Baur**, Oberstaufen (DE); **Franz Haser**, Oberstaufen (DE); **Lamello AG**, Bubendorf (CH)

(\*\*) Term: **14 Years**

(21) Appl. No.: **29/471,333**

(22) Filed: **Oct. 30, 2013**

(30) **Foreign Application Priority Data**

Apr. 30, 2013	(DE)	10 2013 207 966
Apr. 30, 2013	(EM)	002230250
Apr. 30, 2013	(EM)	002230250-0001
Apr. 30, 2013	(EM)	002230250-0002
Apr. 30, 2013	(EM)	002230250-0003
Apr. 30, 2013	(EM)	002230250-0007
Apr. 30, 2013	(EM)	002230250-0008
Apr. 30, 2013	(EM)	002230250-0009

(51) **LOC (10) Cl.** ..... **08-08**

(52) **U.S. Cl.**  
USPC ..... **D8/382**

(58) **Field of Classification Search**  
USPC ..... D8/382, 339, 341, 336, 331, 396, 349;  
24/92; 403/408.1, 245, 256, 257, 321,  
403/292; 292/241

CPC .. F16L 37/08; F16L 37/0845; A47B 88/0407;  
B29C 53/785; E04B 2001/2424; E04B  
2001/2454; F16B 2/12; F16B 2/06

See application file for complete search history.

(56) **References Cited**

U.S. PATENT DOCUMENTS

4,641,988	A *	2/1987	Ganner	403/245
4,826,222	A *	5/1989	Davis	292/241
5,517,730	A *	5/1996	Ho	24/92
5,529,428	A *	6/1996	Bischof	403/408.1
5,730,544	A *	3/1998	Dils et al.	403/292
D422,893	S *	4/2000	Heredos-Formby	D8/382
D484,030	S *	12/2003	Thach	D8/382
D525,111	S *	7/2006	Farrell et al.	D8/331
D528,400	S *	9/2006	Vetter	D8/331
D531,887	S *	11/2006	Rimer, Jr.	D8/382
D539,129	S *	3/2007	Griffiths	D8/382
D560,484	S *	1/2008	Smith	D8/396
D640,537	S *	6/2011	Parks et al.	D8/396
8,092,114	B2	1/2012	Baur et al.	
D686,903	S *	7/2013	Guichot	D8/331
2010/0111598	A1	5/2010	Baur et al.	

FOREIGN PATENT DOCUMENTS

BE	508737	7/1953
DE	931 727	8/1955
DE	100 45 744	3/2002
EP	1 990 549	11/2008

OTHER PUBLICATIONS

Clamex P-14, Lamello [online], [retrieved on Mar. 3, 2015]. Retrieved from the Internet <URL: <http://www.lamello.com/en/home/join-wood/p-system/clamex-p-14.html>>.\*

\* cited by examiner

*Primary Examiner* — Sheryl Lane  
*Assistant Examiner* — Nicole Shiflet

(74) *Attorney, Agent, or Firm* — Hanley, Flight & Zimmerman, LLC

(57) **CLAIM**

The ornamental design for a connecting assembly including a male portion and a female portion, as shown and described.

**DESCRIPTION**

FIG. 1 is a perspective view of a male portion of a connecting assembly.

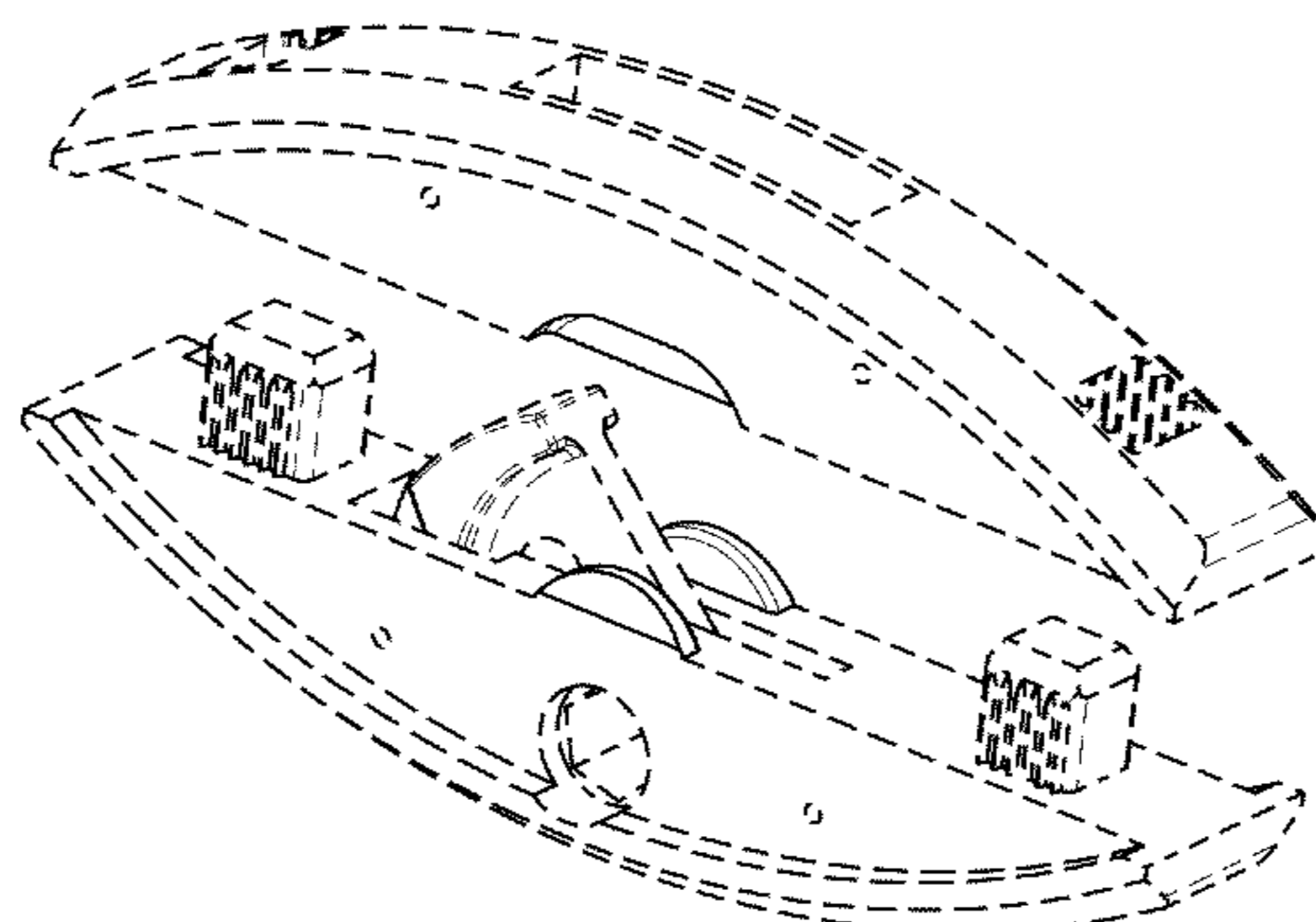

FIG. 2 is a left side view of the male portion of FIG. 1 of the connecting assembly.

FIG. 3 is a first end view of the male portion of FIG. 1 of the connecting assembly.

FIG. 4 is a right side view of the male portion of FIG. 1 of the connecting assembly.

FIG. 5 is a second end view of the male portion of FIG. 1 of the connecting assembly.

FIG. 6 is a top view of the male portion of FIG. 1 of the connecting assembly.

FIG. 7 is a bottom view of the male portion of FIG. 1 of the connecting assembly.

FIG. 8 is a perspective view of a female portion of a connecting assembly.

FIG. 9 is a left side view of the female portion of FIG. 8 of the connecting assembly.

FIG. 10 is a first end view of the female portion of FIG. 8 of the connecting assembly.

FIG. 11 is a right side view of the female portion of FIG. 8 of the connecting assembly.

FIG. 12 is a second end view of the female portion of FIG. 8 of the connecting assembly.

FIG. 13 is a top view of the female portion of FIG. 8 of the connecting assembly.

FIG. 14 is a bottom view of the female portion of FIG. 8 of the connecting assembly.

FIG. 15 is a perspective view of a connecting assembly including the female portion of FIG. 8 and the male portion of FIG. 1.

FIG. 16 is a left side view of the connecting assembly of FIG. 15 including the female portion of FIG. 8 and the male portion of FIG. 1.

FIG. 17 is a first end view of the connecting assembly of FIG. 15 including the female portion of FIG. 8 and the male portion of FIG. 1.

FIG. 18 is a right side view of the connecting assembly of FIG. 15 including the female portion of FIG. 8 and the male portion of FIG. 1.

FIG. 19 is a second end view of the of the connecting assembly of FIG. 15 including the female portion of FIG. 8 and the male portion of FIG. 1.

FIG. 20 is a top view of the connecting assembly of FIG. 15 including the female portion of FIG. 8 and the male portion of FIG. 1.

FIG. 21 is a bottom view of the connecting assembly of FIG. 15 including the female portion of FIG. 8 and the male portion of FIG. 1.

FIG. 22 is a perspective view of a male portion of a second embodiment of a connecting assembly.

FIG. 23 is a left side view of the male portion of FIG. 22 of the connecting assembly.

FIG. 24 is a first end view of the male portion of FIG. 22 of the connecting assembly.

FIG. 25 is a right side view of the male portion of FIG. 22 of the connecting assembly.

FIG. 26 is a second end view of the male portion of FIG. 22 of the connecting assembly.

FIG. 27 is a top view of the male portion of FIG. 22 of the connecting assembly.

FIG. 28 is a bottom view of the male portion of FIG. 22 of the connecting assembly.

FIG. 29 is a perspective view of a second embodiment of a female portion of a connecting assembly.

FIG. 30 is a left side view of the female portion of FIG. 29 of the connecting assembly.

FIG. 31 is a first end view of the female portion of FIG. 29 of the connecting assembly.

FIG. 32 is a right side view of the female portion of FIG. 29 of the connecting assembly.

FIG. 33 is a second end view of the female portion of FIG. 29 of the connecting assembly.

FIG. 34 is a top view of the female portion of FIG. 29 of the connecting assembly.

FIG. 35 is a bottom view of the female portion of FIG. 29 of the connecting assembly.

FIG. 36 is a perspective view of a connecting assembly including the female portion of FIG. 29 and the male portion of FIG. 22.

FIG. 37 is a left side view of the connecting assembly of FIG. 36 including the female portion of FIG. 29 and the male portion of FIG. 22.

FIG. 38 is a first end view of the connecting assembly of FIG. 36 including the female portion of FIG. 29 and the male portion of FIG. 22.

FIG. 39 is a right side view of the connecting assembly of FIG. 36 including the female portion of FIG. 29 and the male portion of FIG. 22.

FIG. 40 is a second end view of the connecting of FIG. 36 including the female portion of FIG. 29 and the male portion of FIG. 22.

FIG. 41 is a top view of the connecting assembly of FIG. 36 including the female portion of FIG. 29 and the male portion of FIG. 22; and,

FIG. 42 is a bottom view of the connecting assembly of FIG. 36 including the female portion of FIG. 29 and the male portion of FIG. 22.

The features shown in broken lines represent portions of the article and form no part of the claimed design.

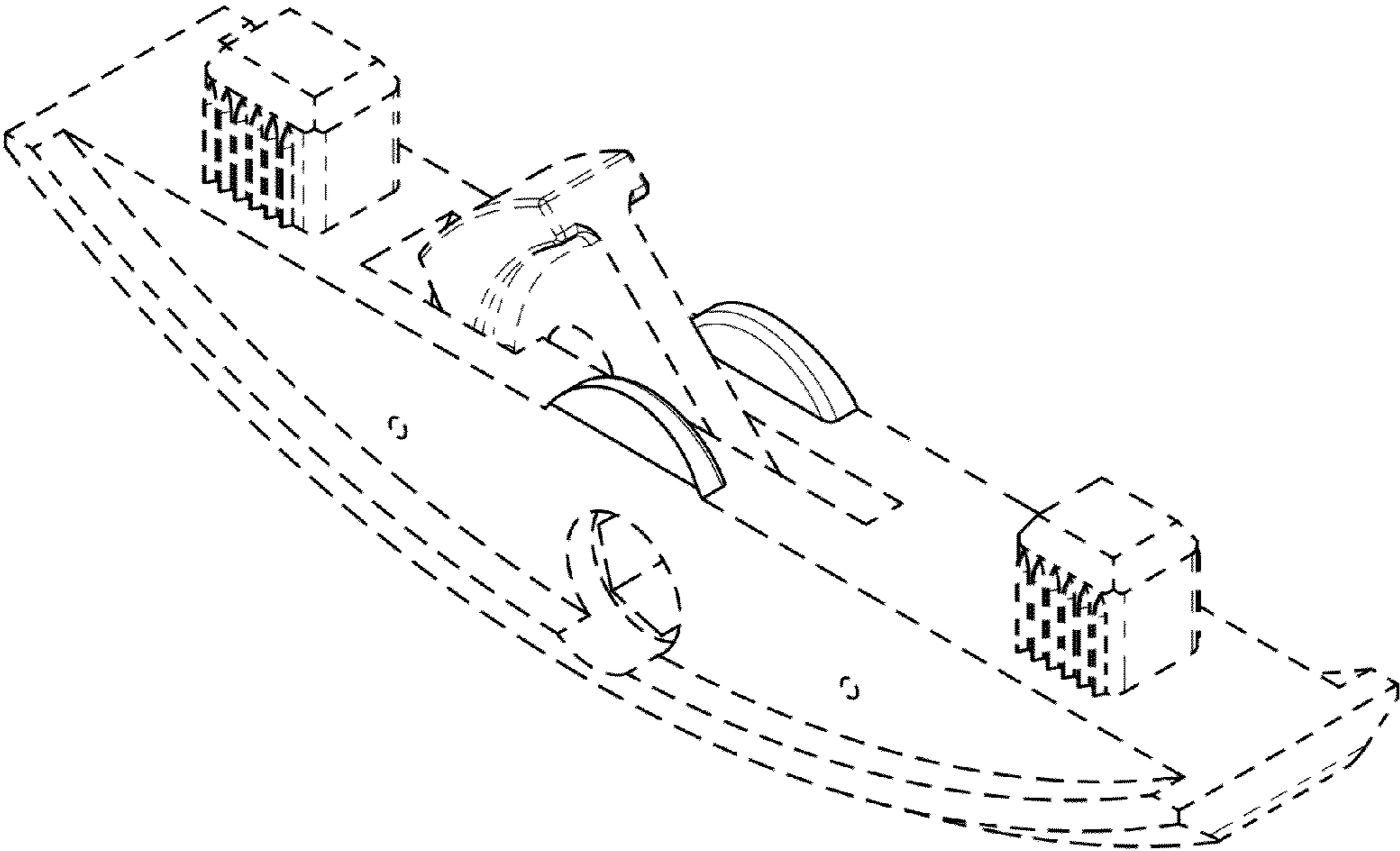

FIG. 1

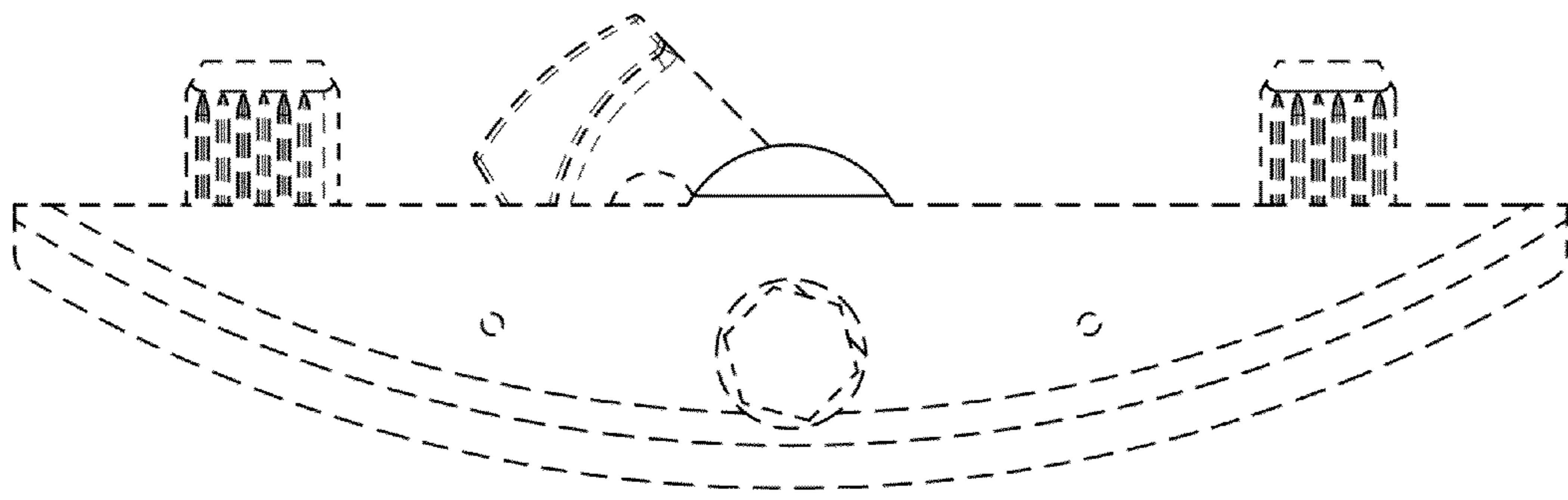

FIG. 2

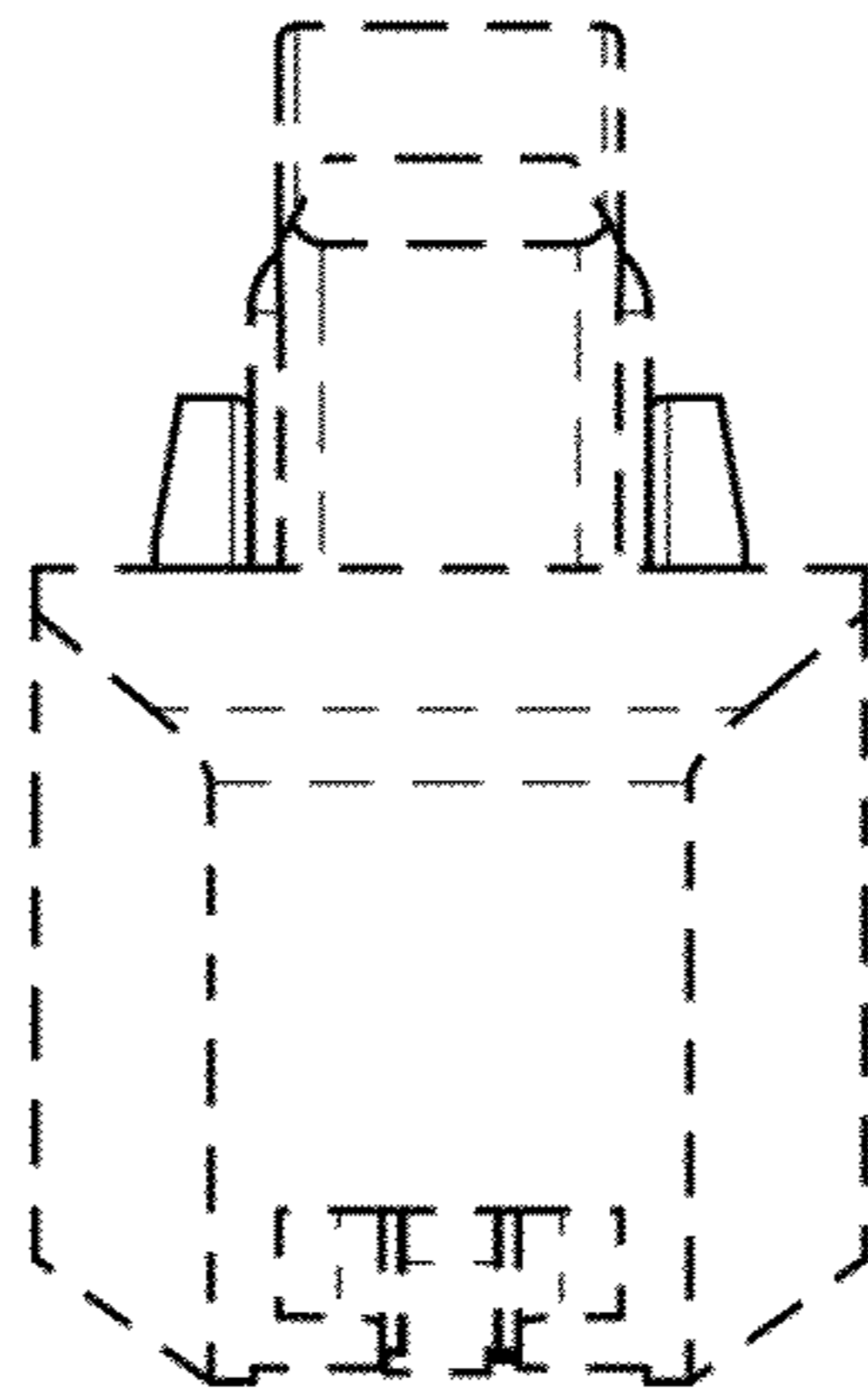

FIG. 3

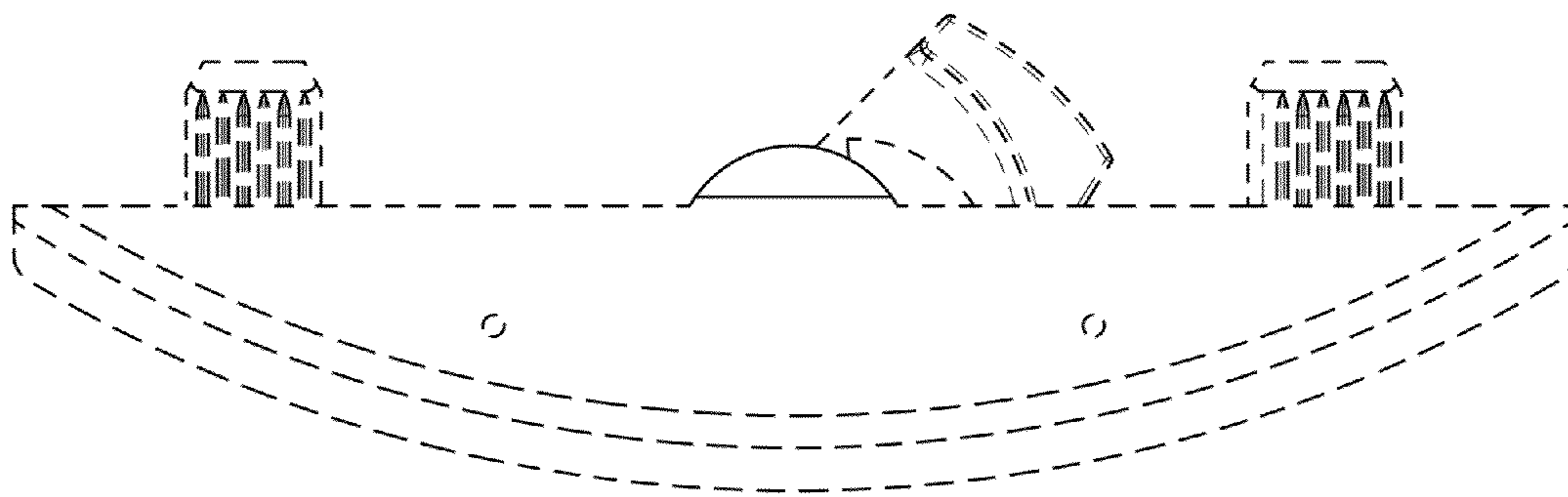

FIG. 4

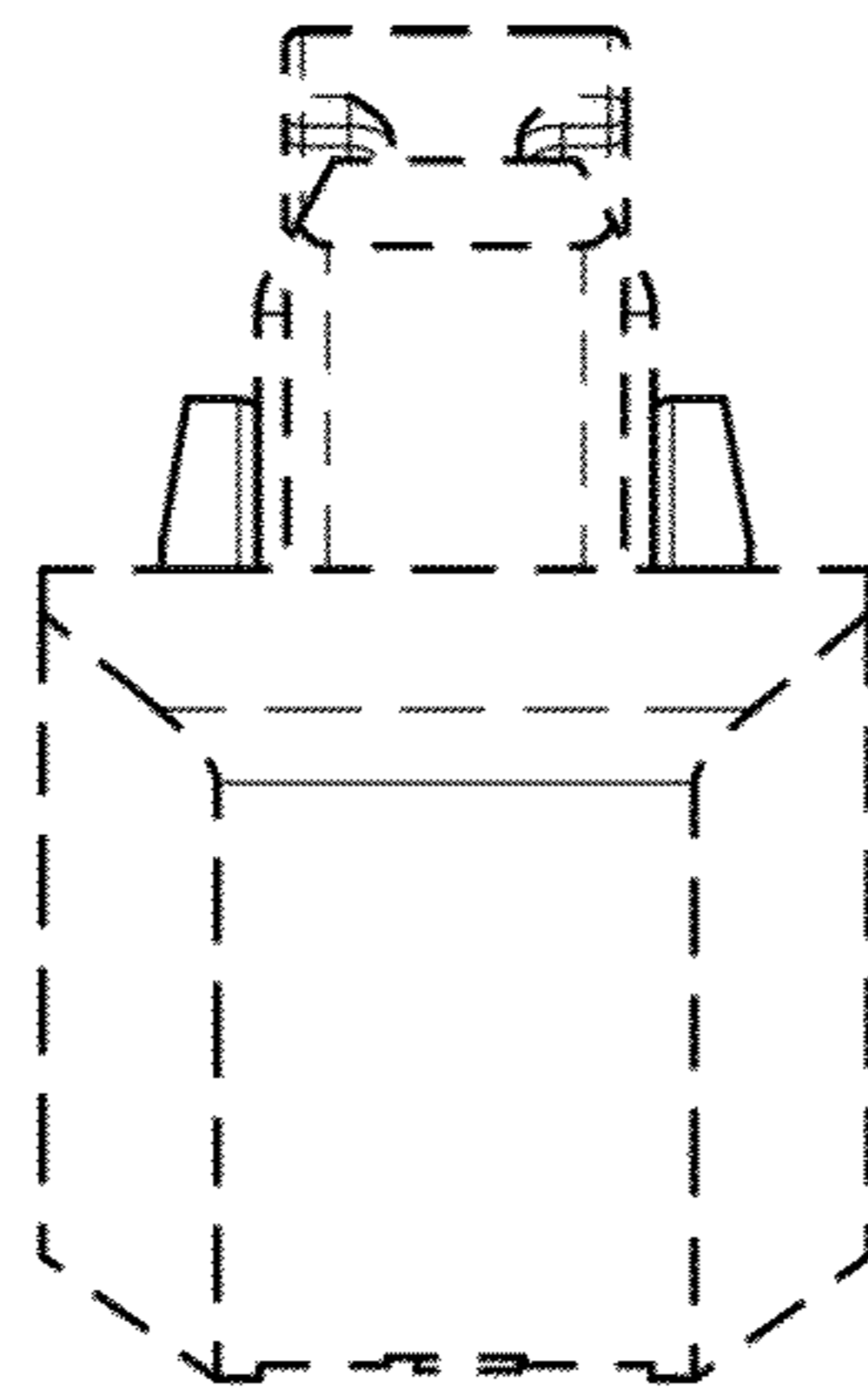

FIG. 5

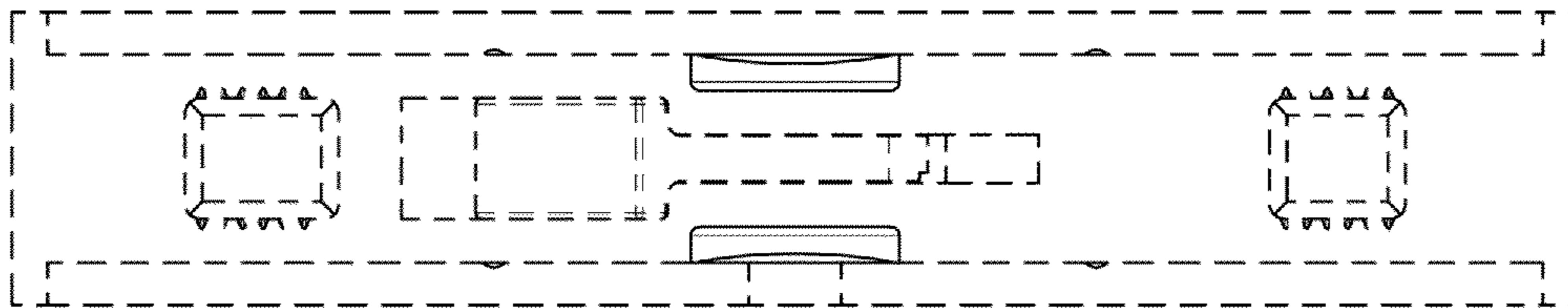

FIG. 6



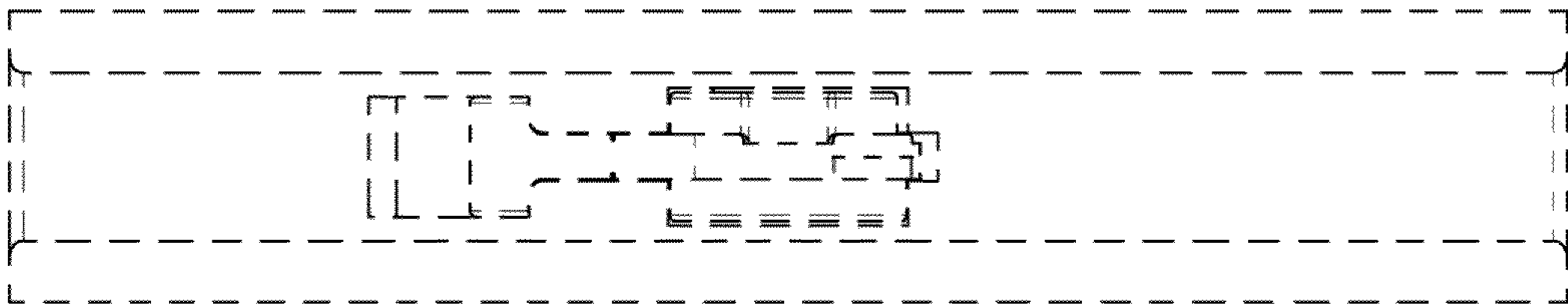

FIG. 7

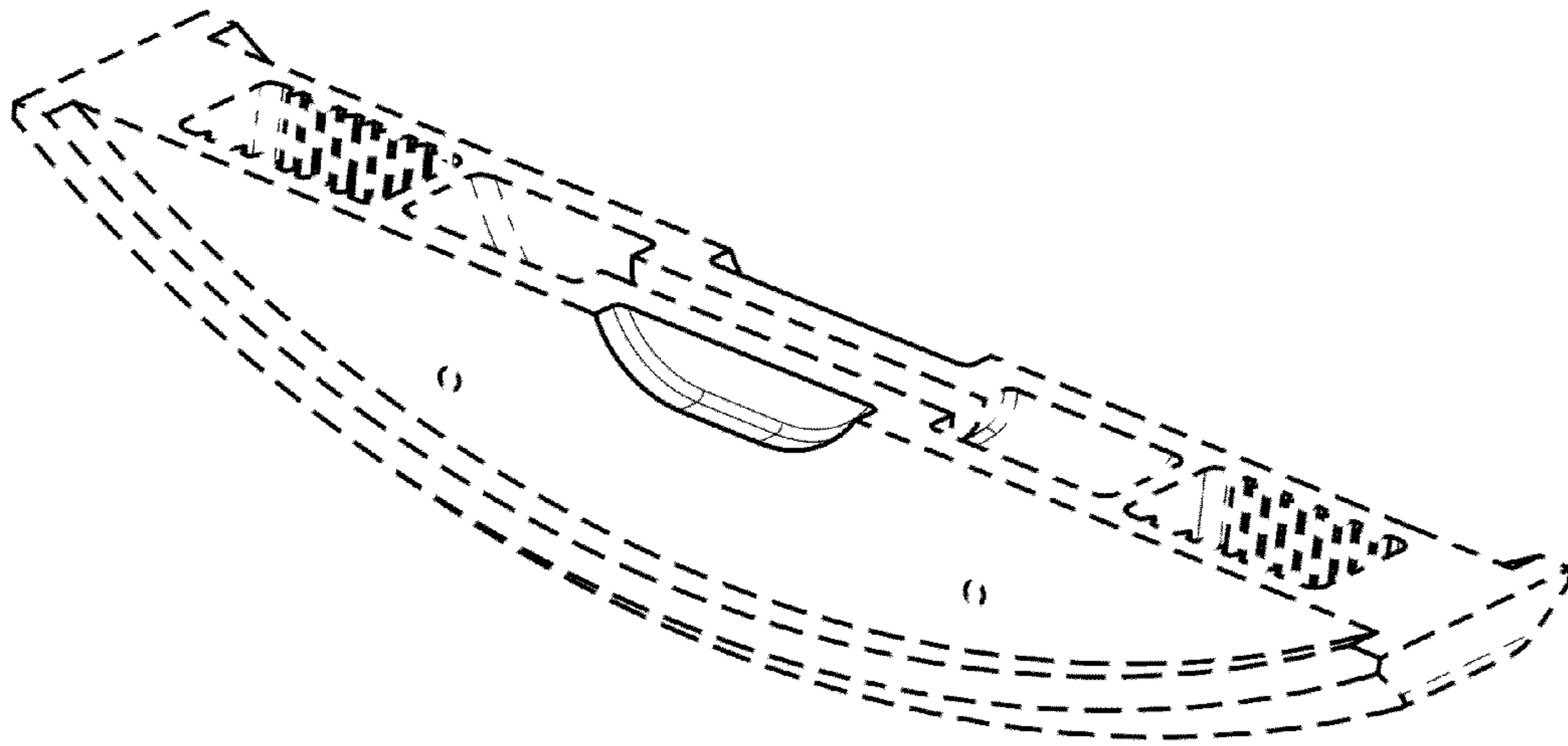

FIG. 8

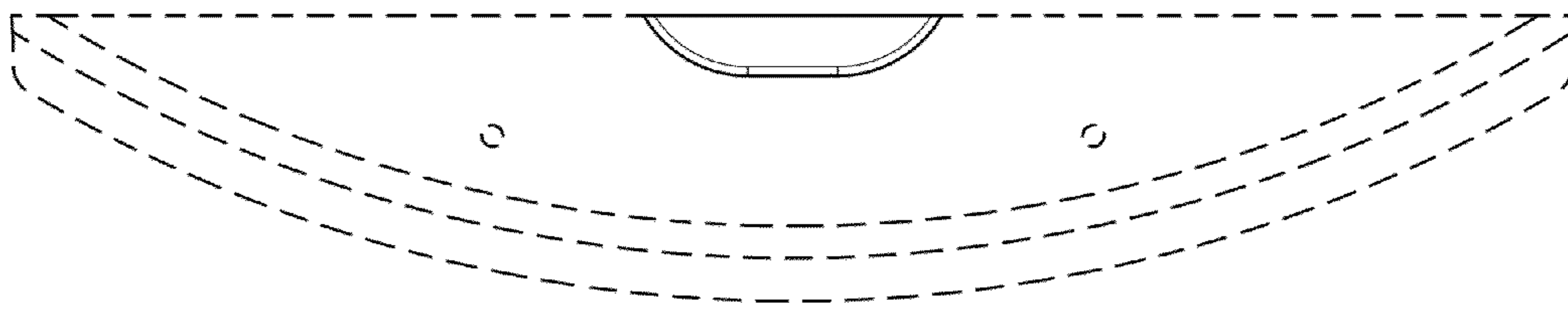

FIG. 9

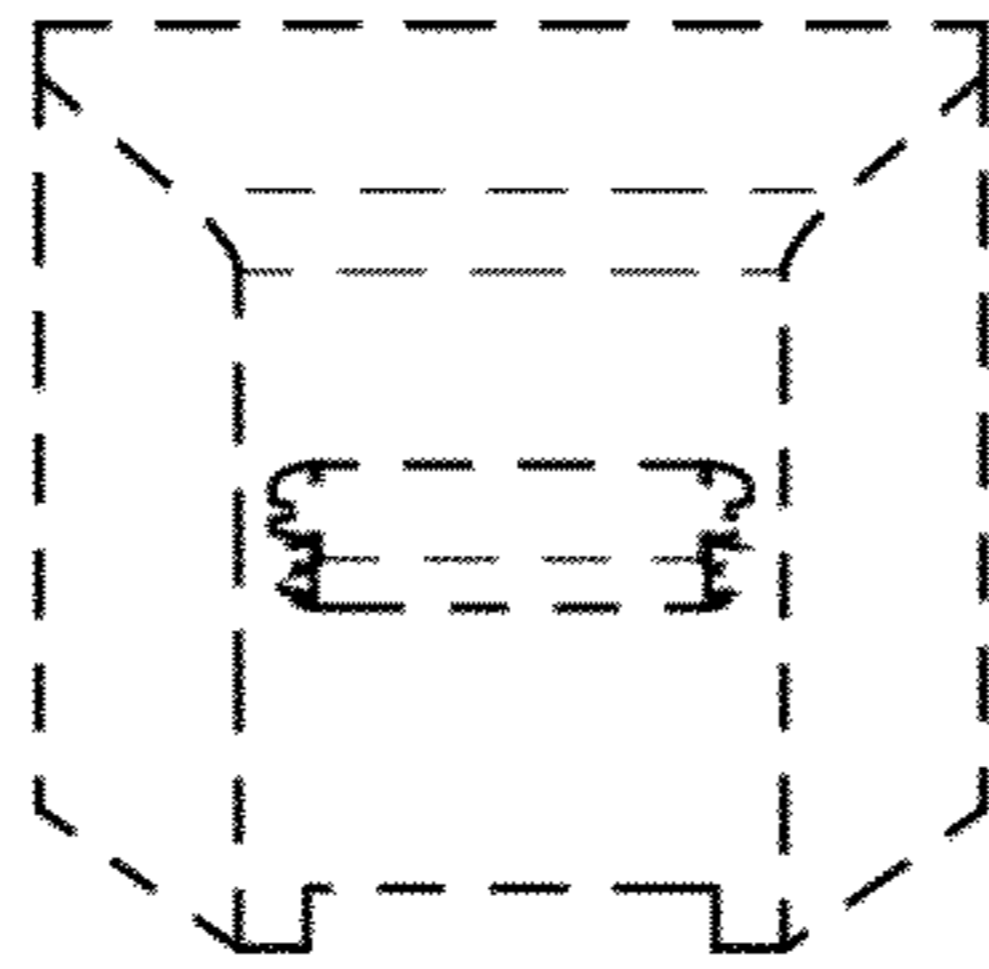

FIG. 10

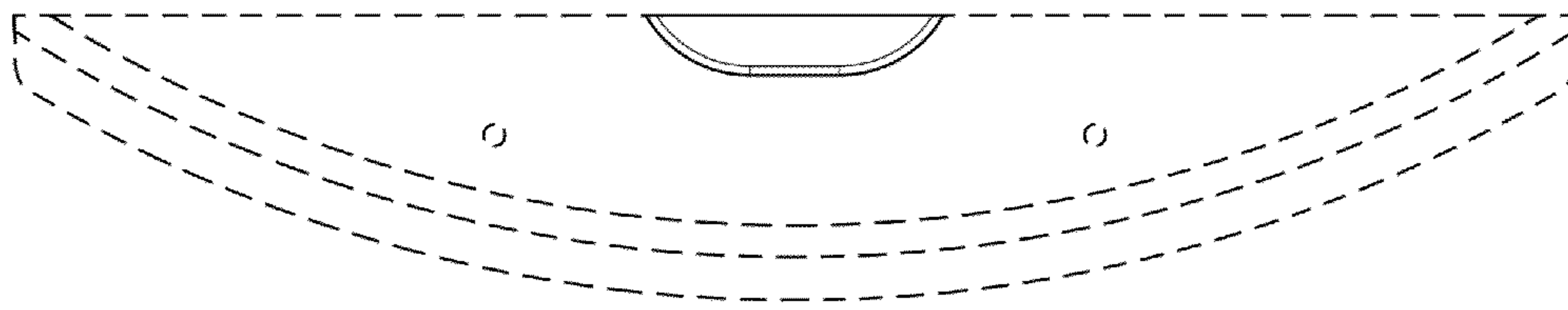

FIG. 11

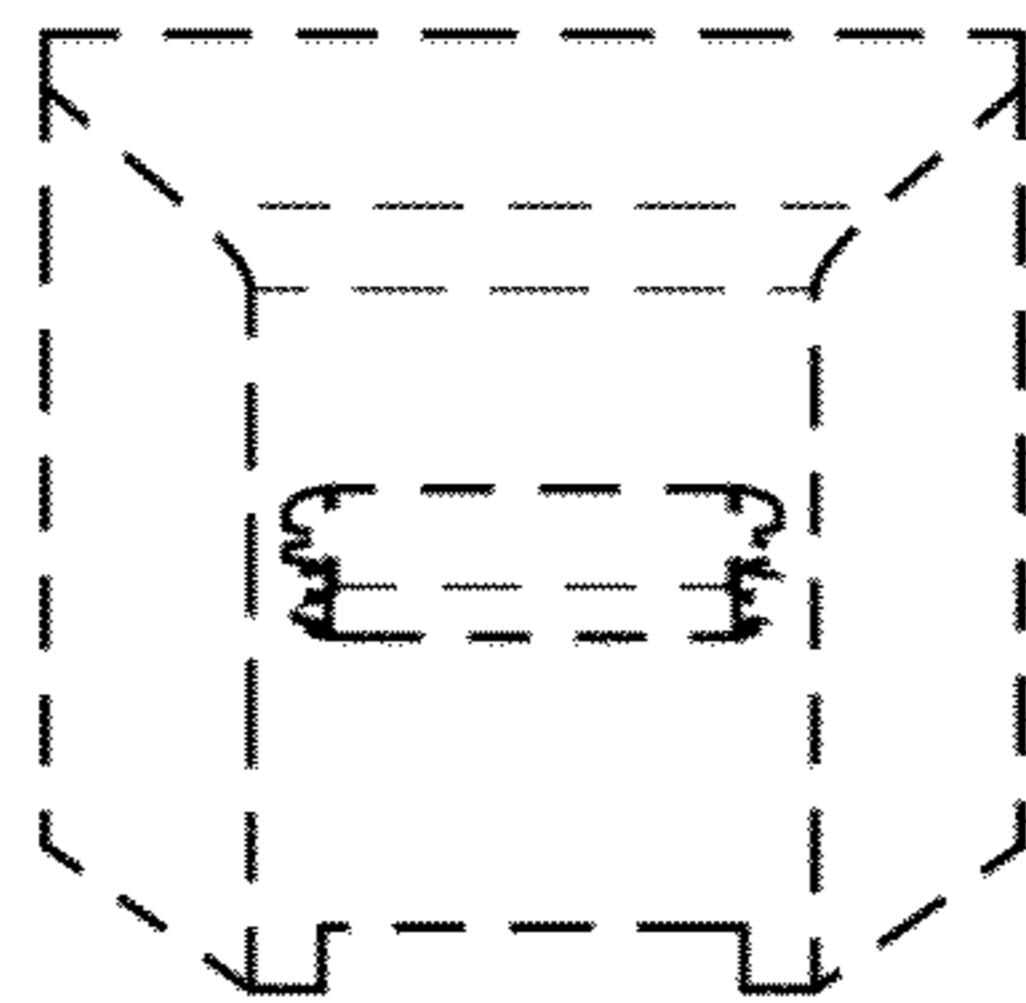

FIG. 12

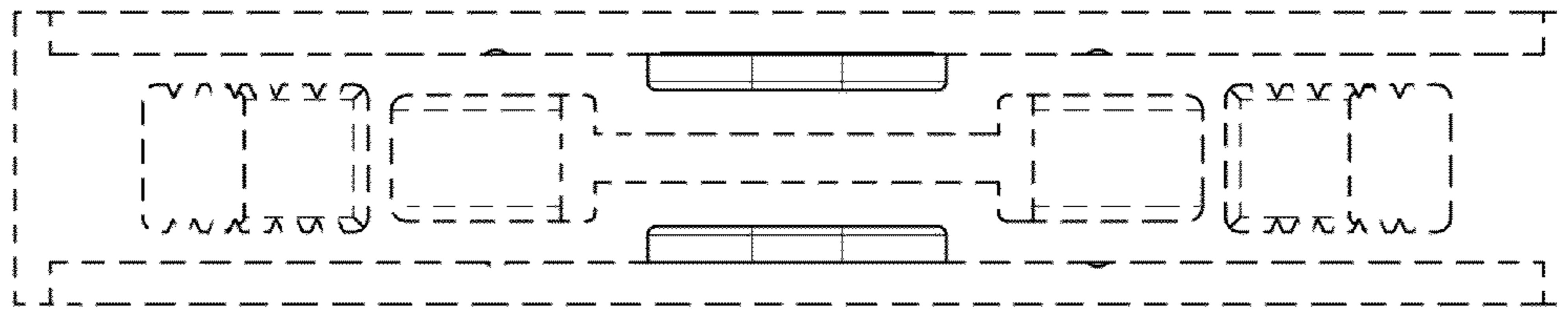

FIG. 13

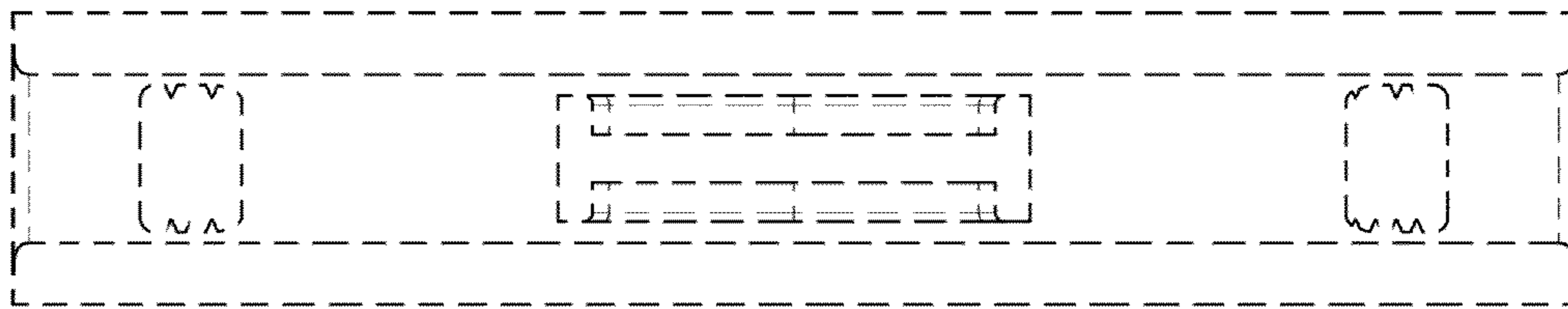

FIG. 14



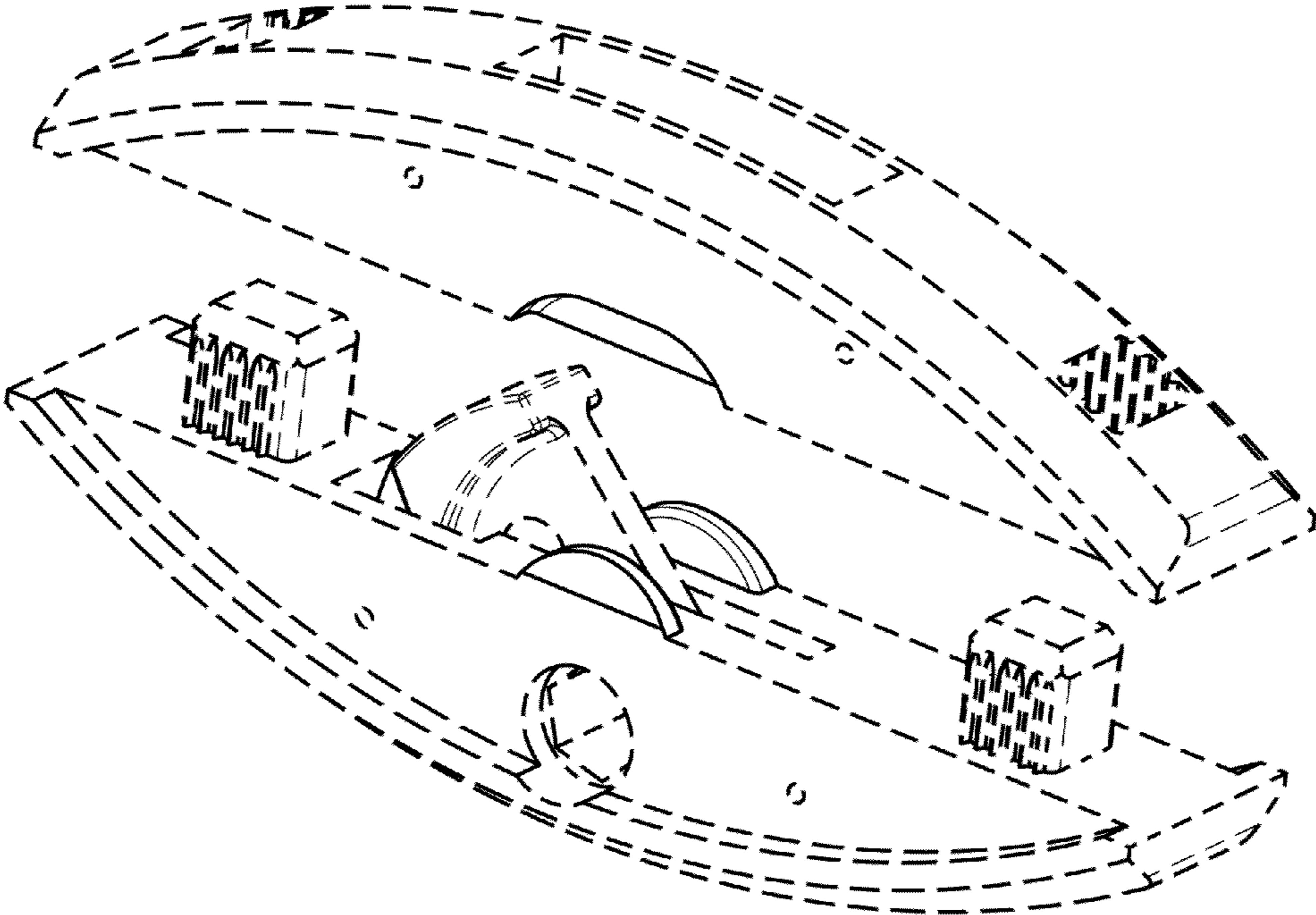

FIG. 15

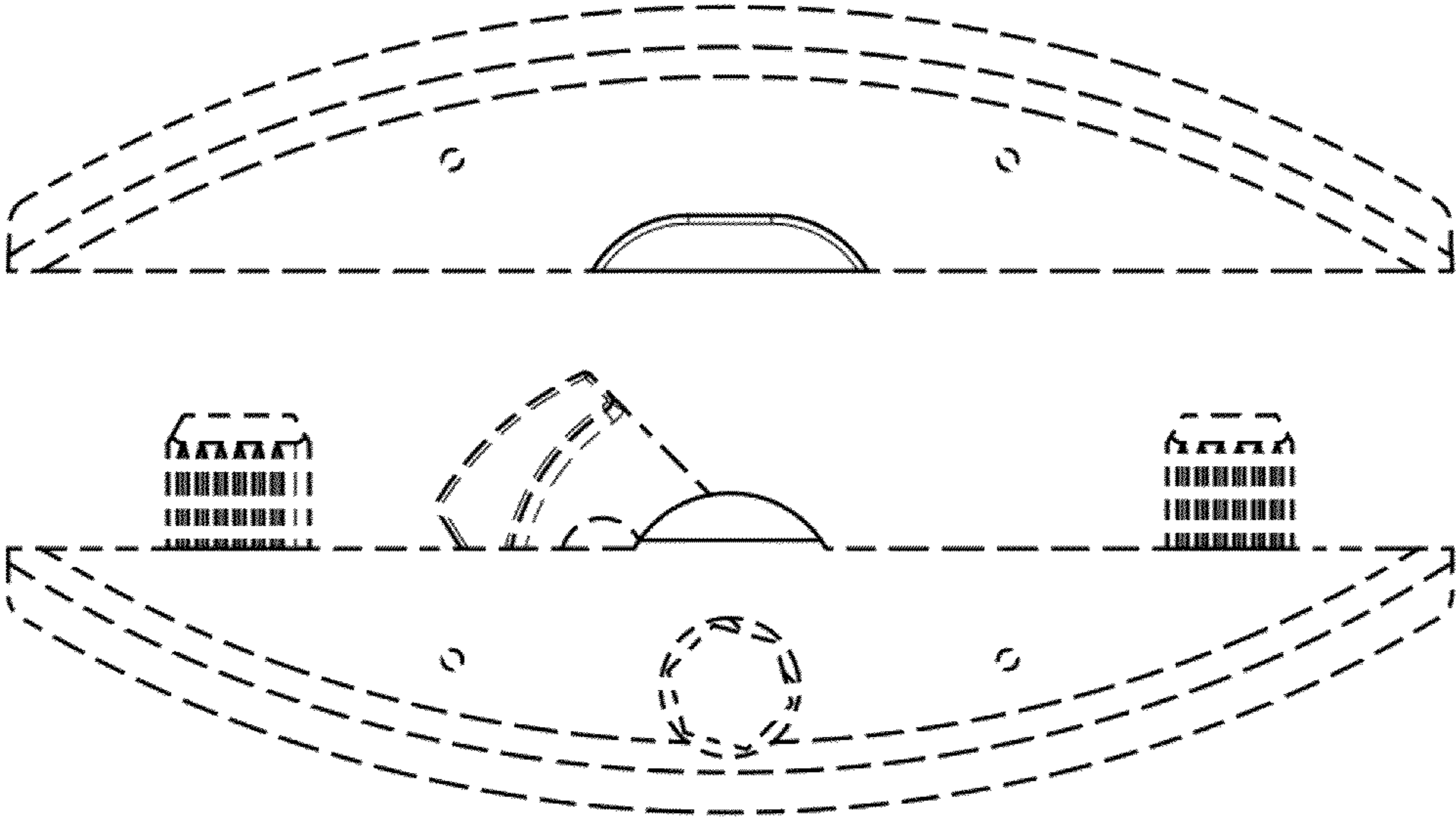

FIG. 16

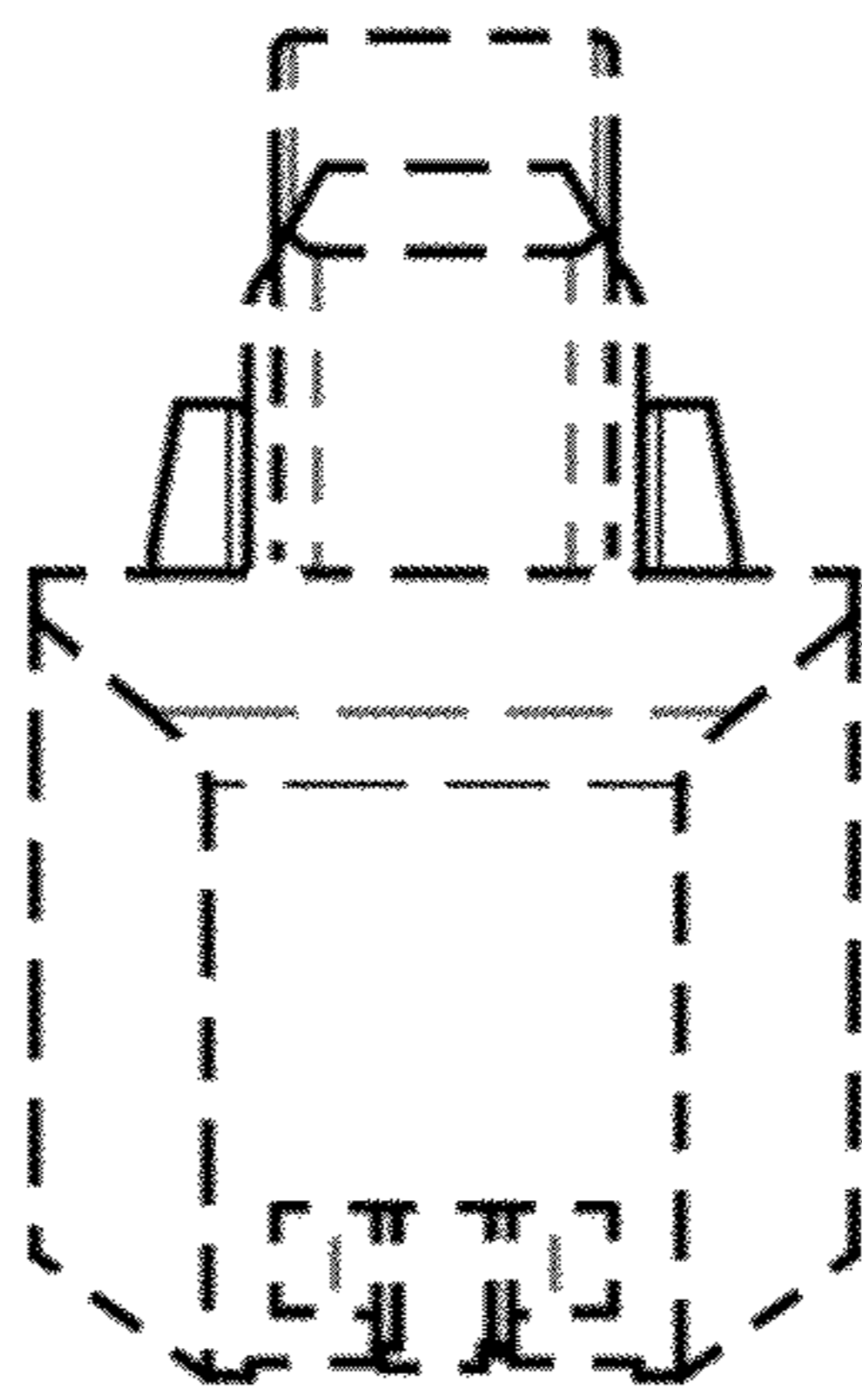
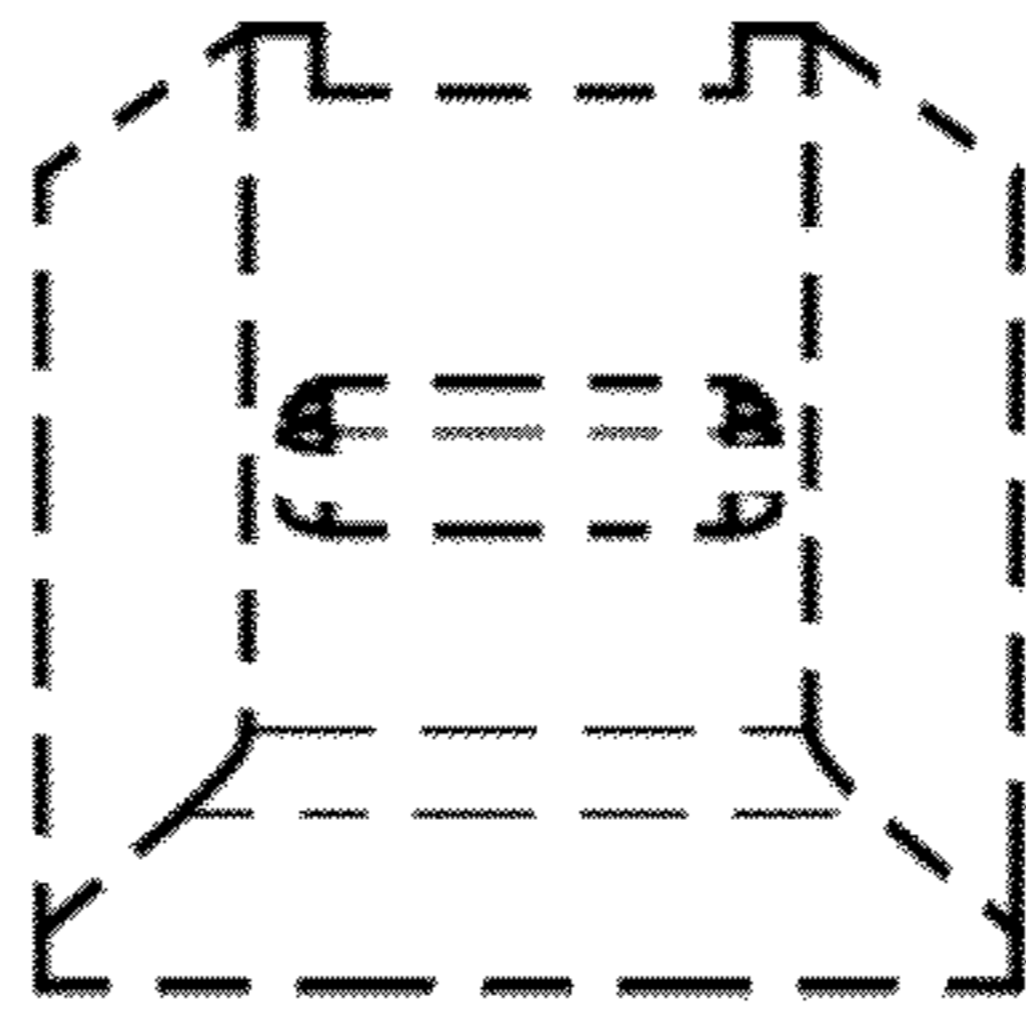

FIG. 17

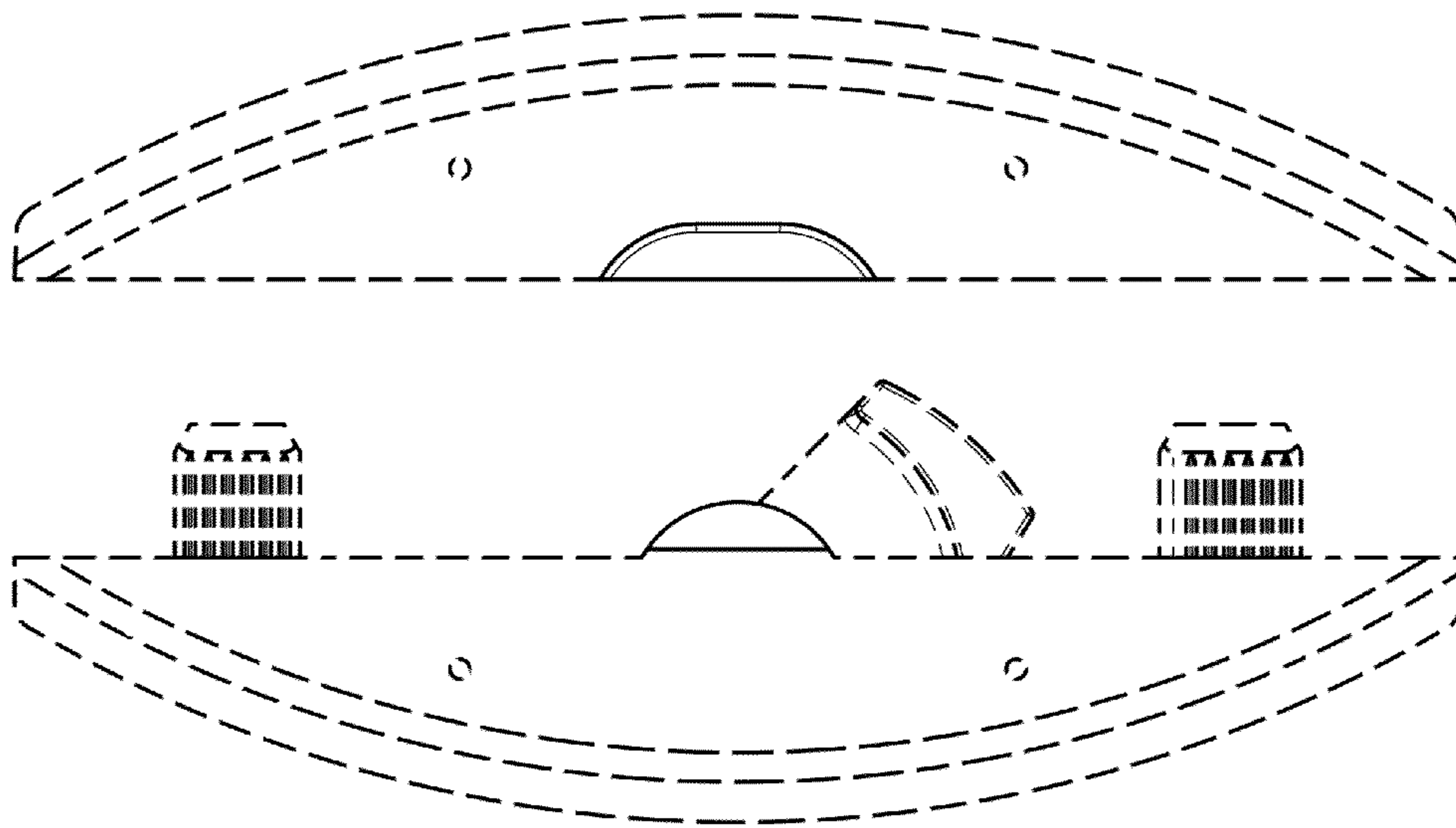

FIG. 18

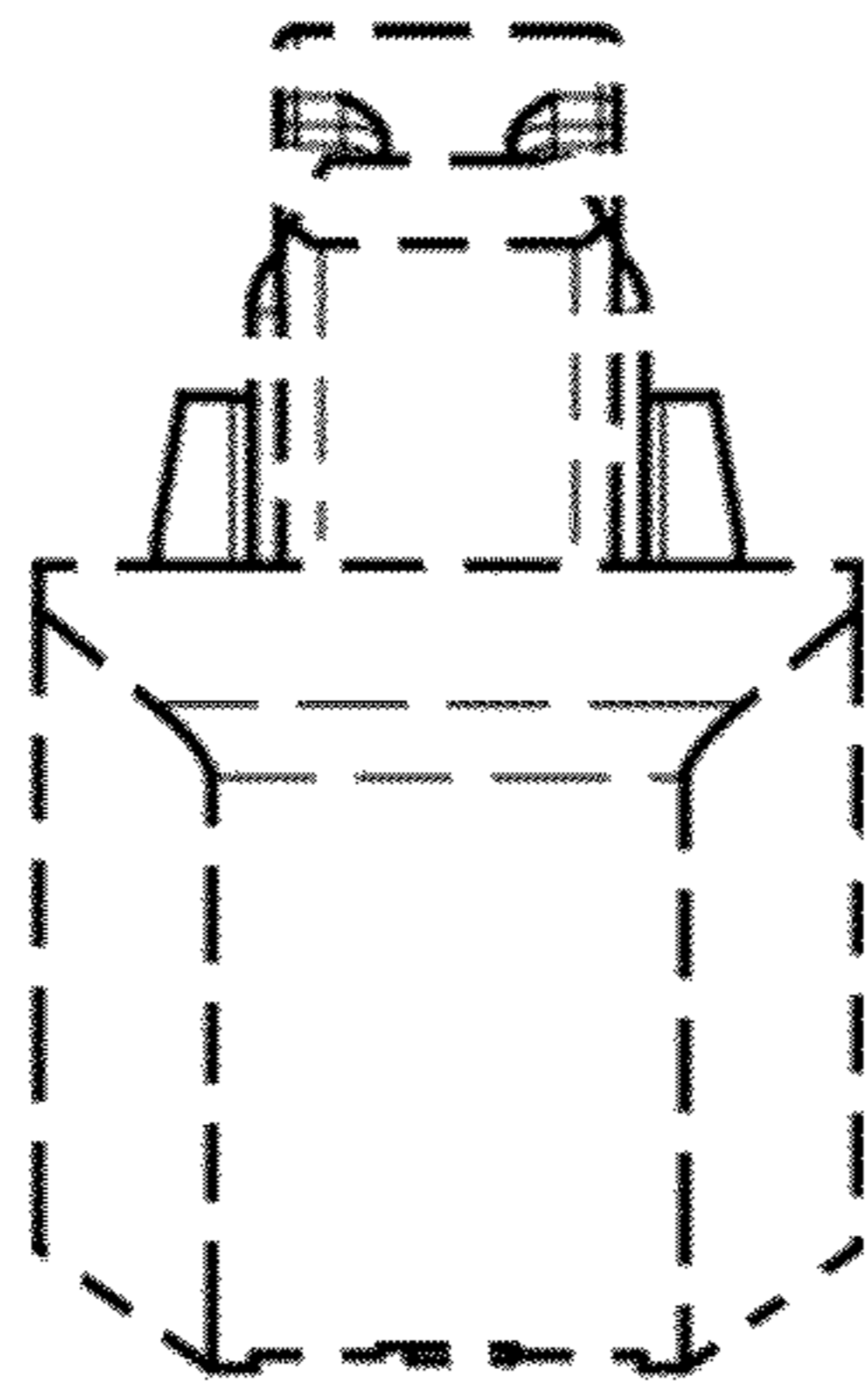
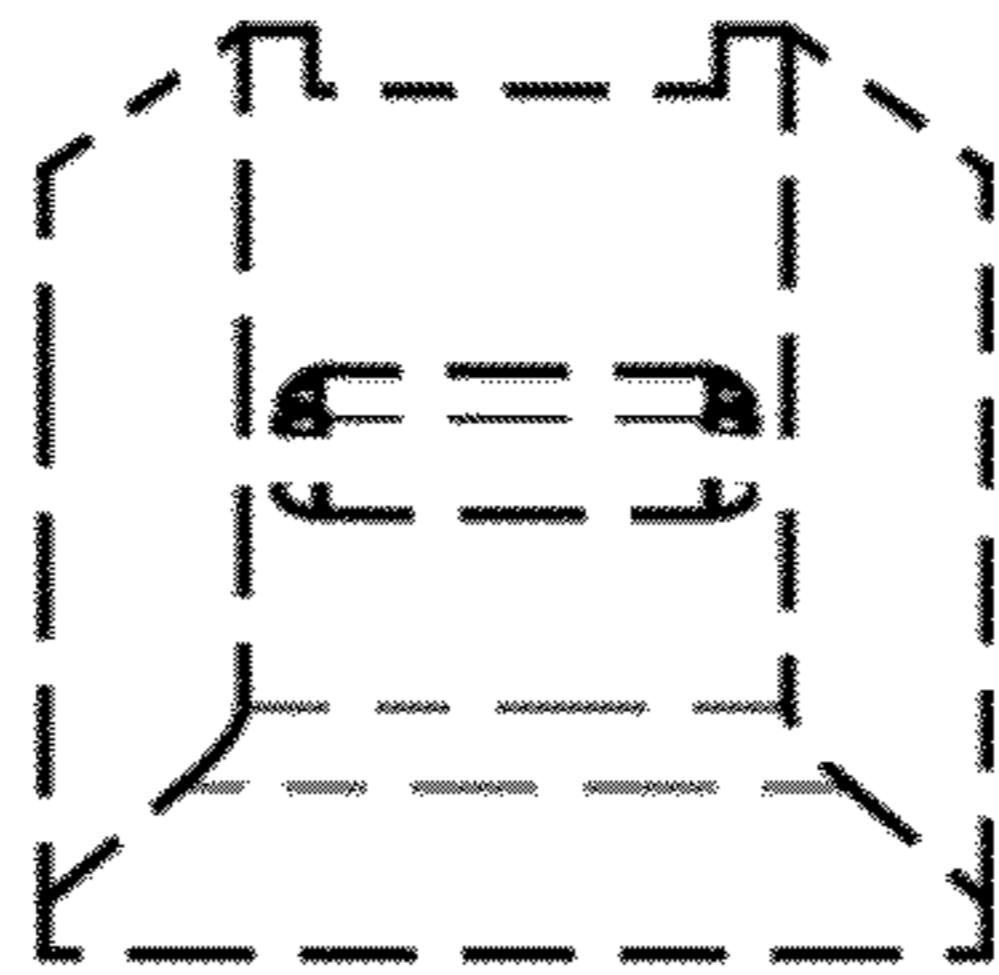

FIG. 19

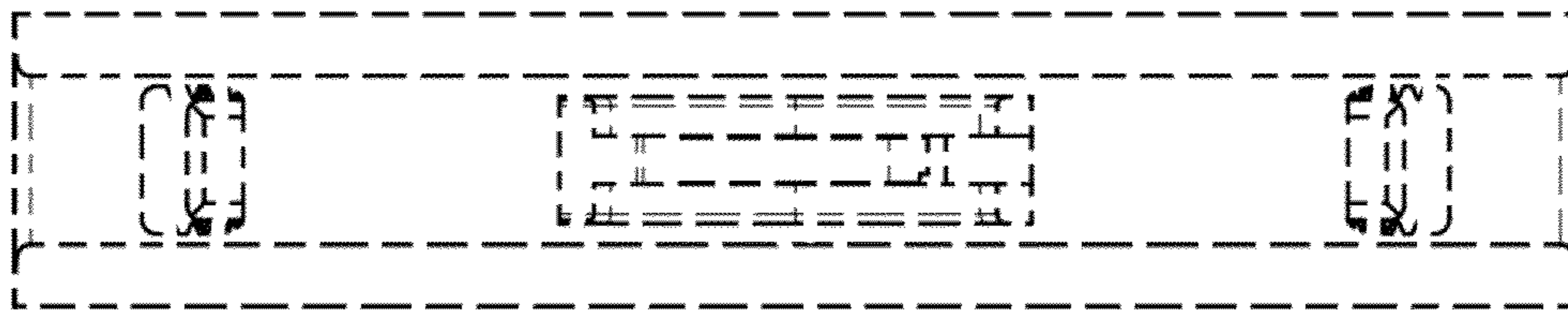

FIG. 20

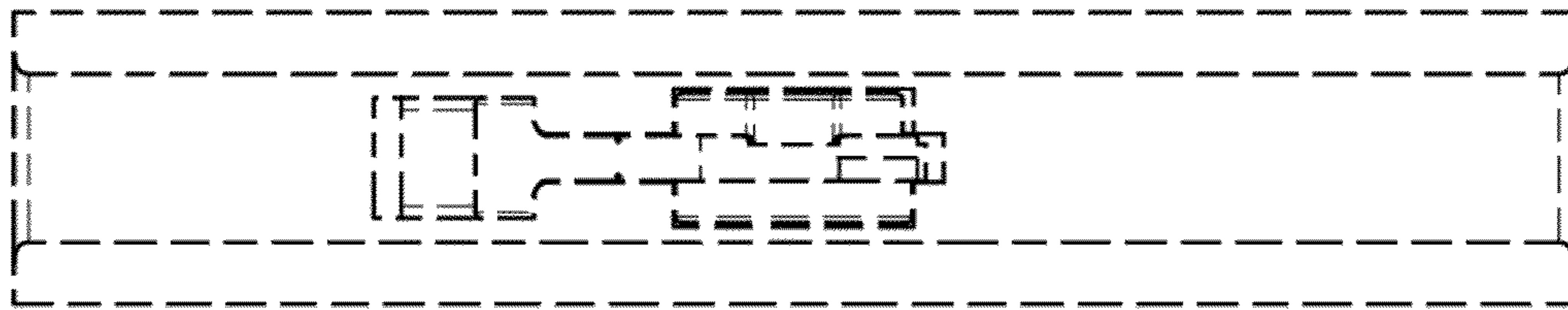

FIG. 21

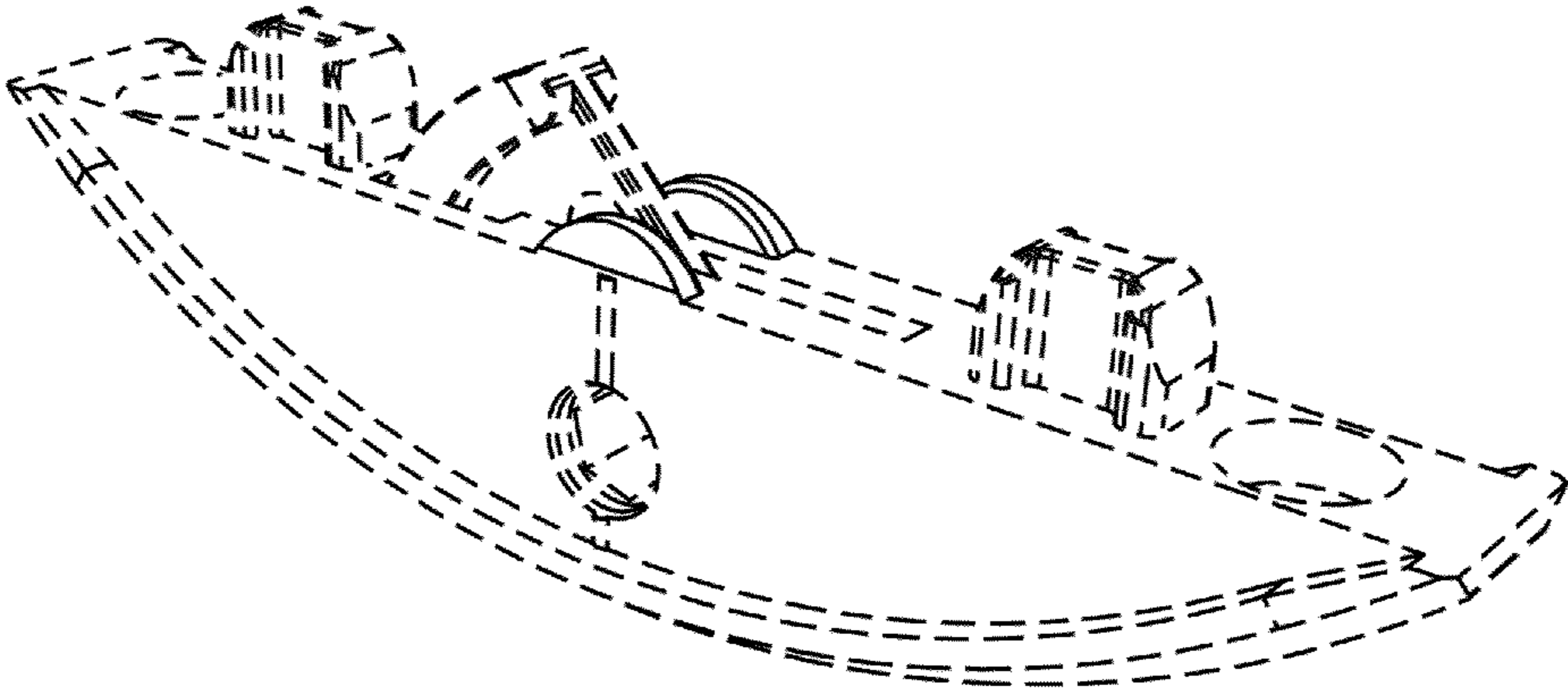

FIG. 22



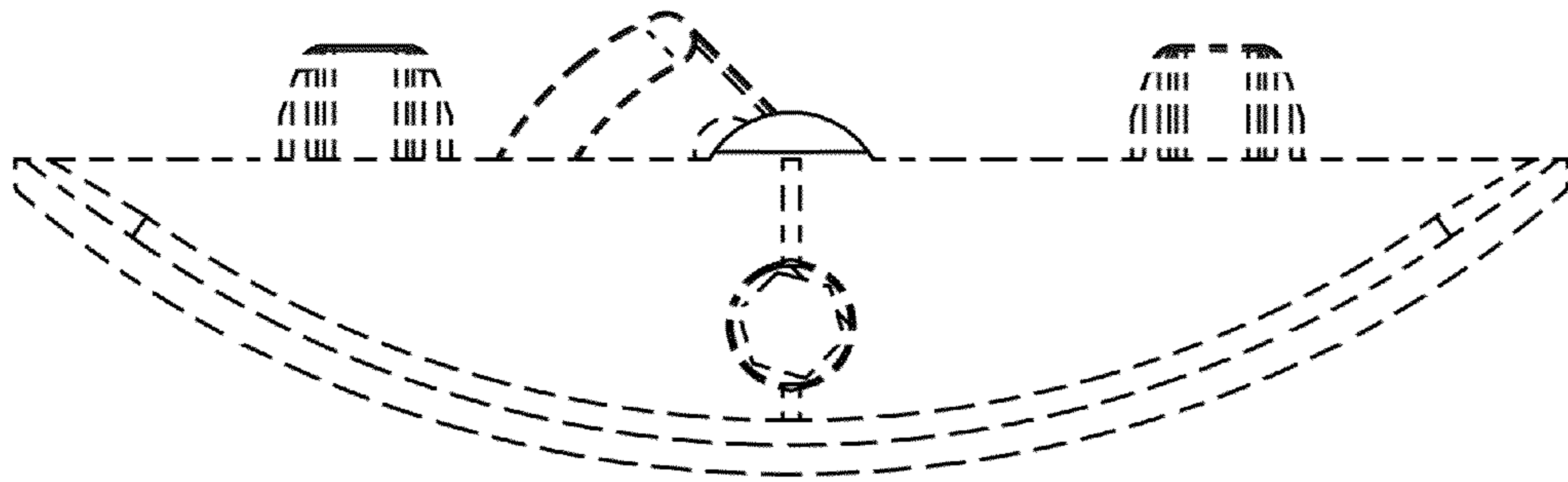

FIG. 23

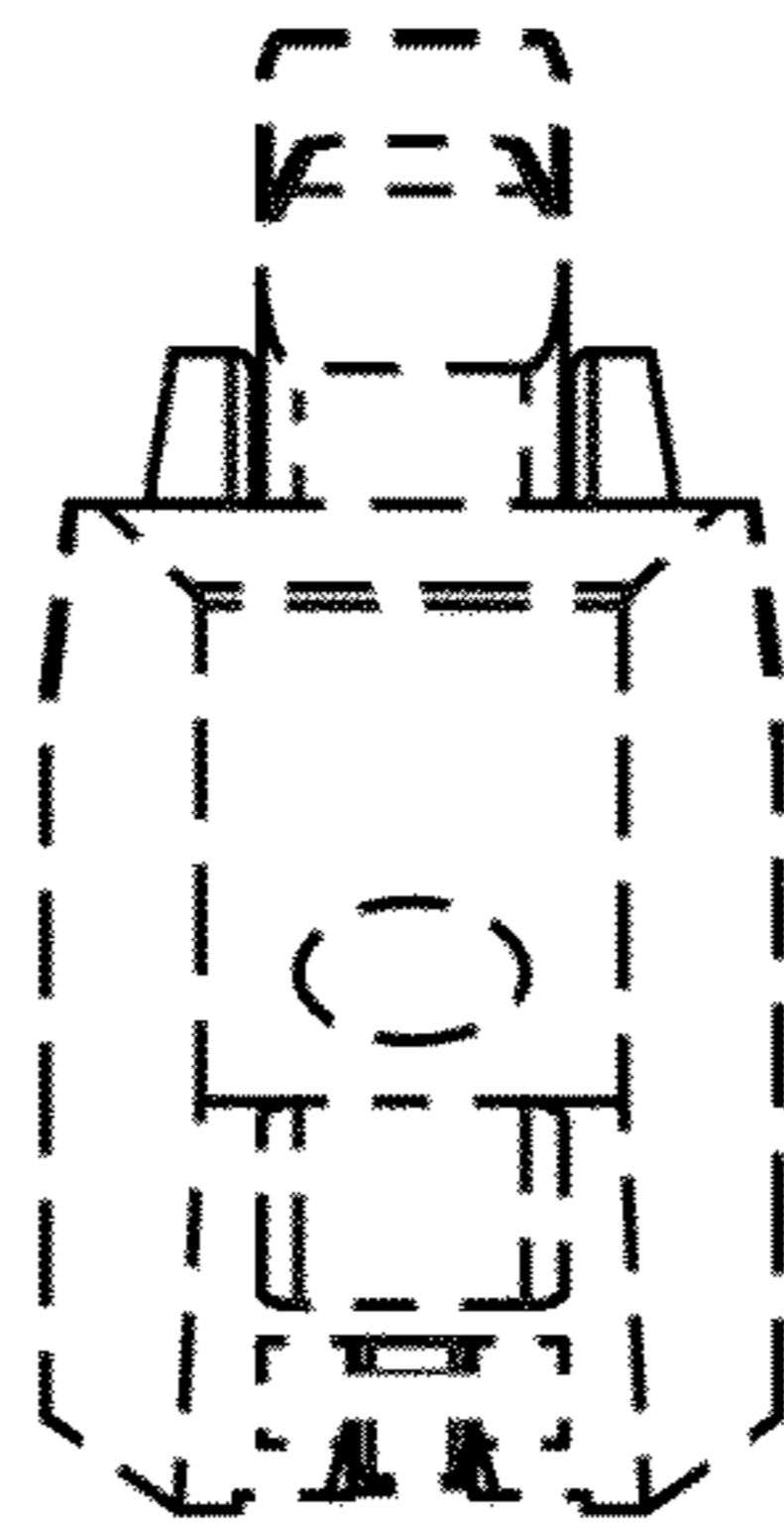

FIG. 24

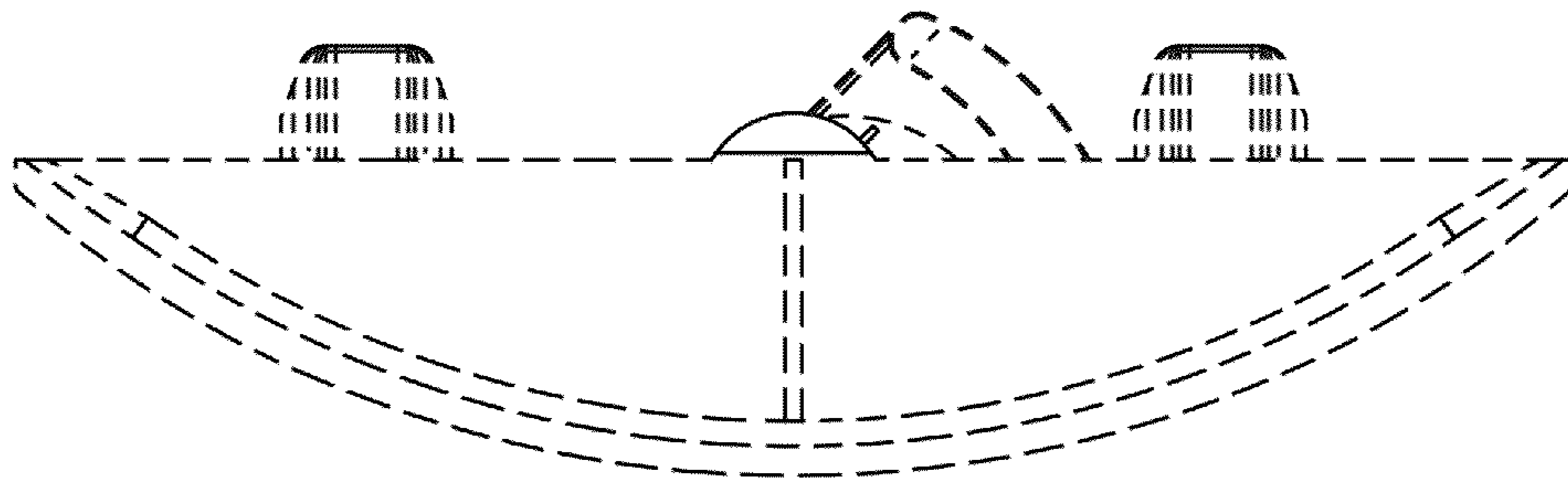

FIG. 25

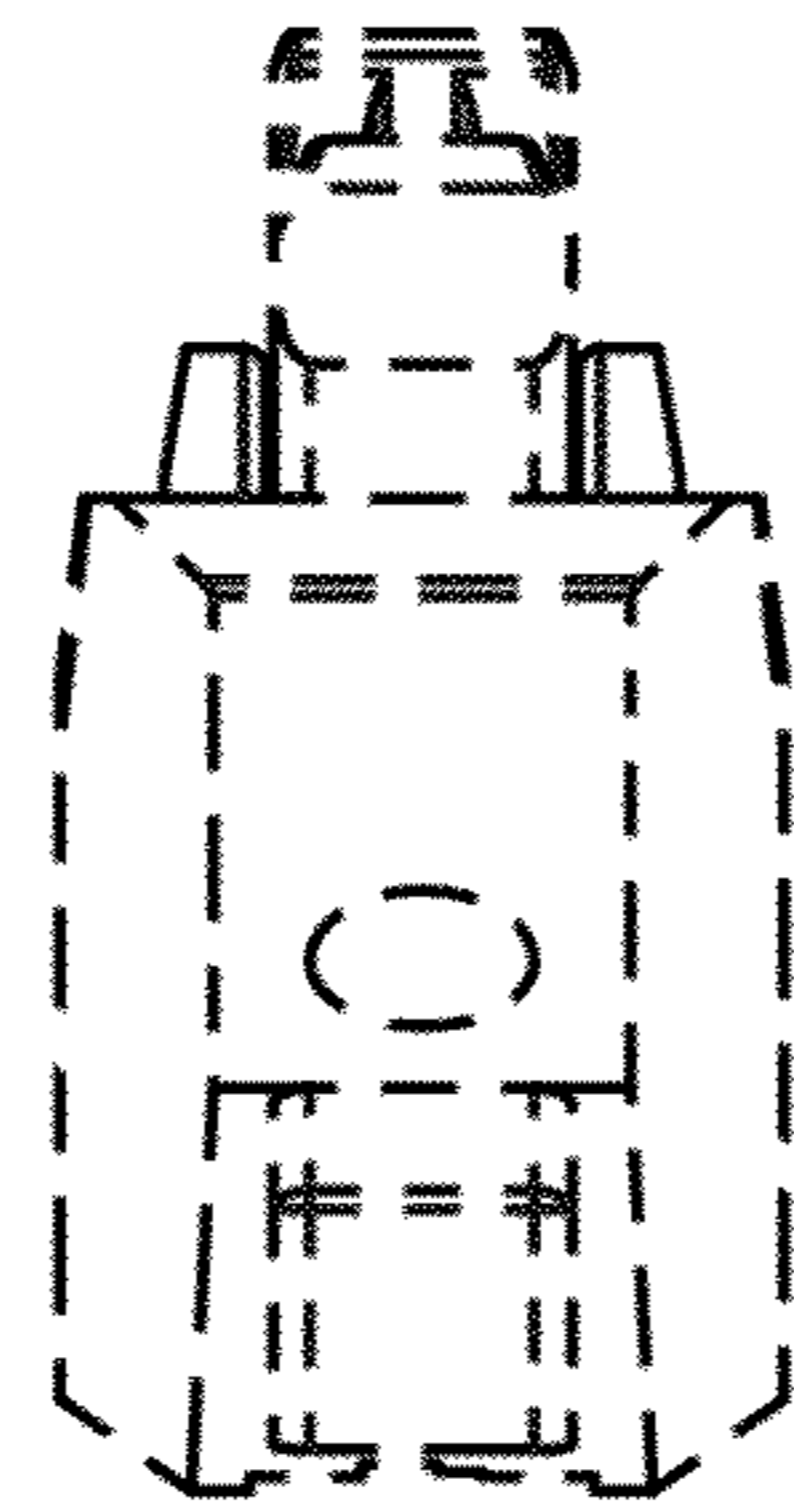

FIG. 26

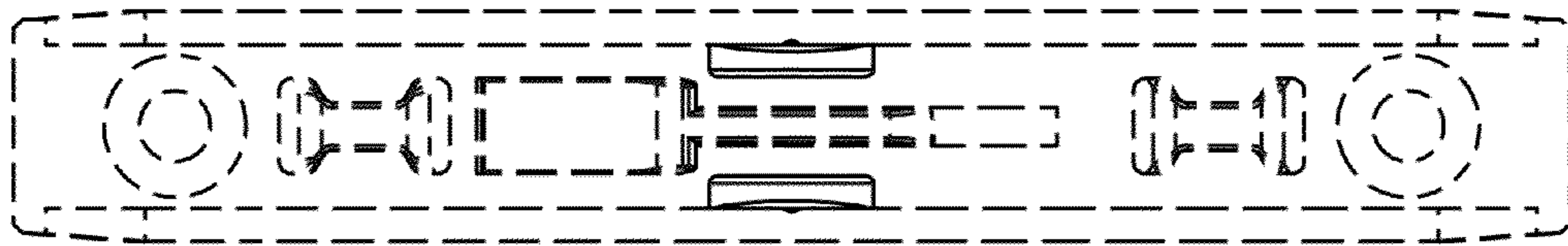

FIG. 27

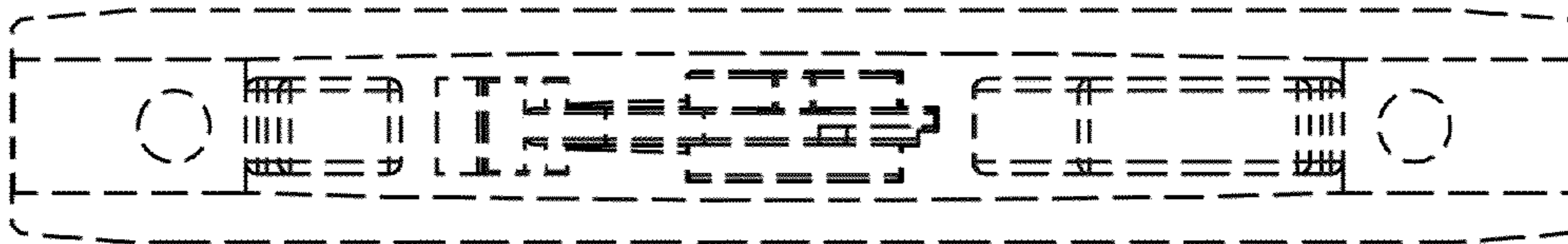

FIG. 28

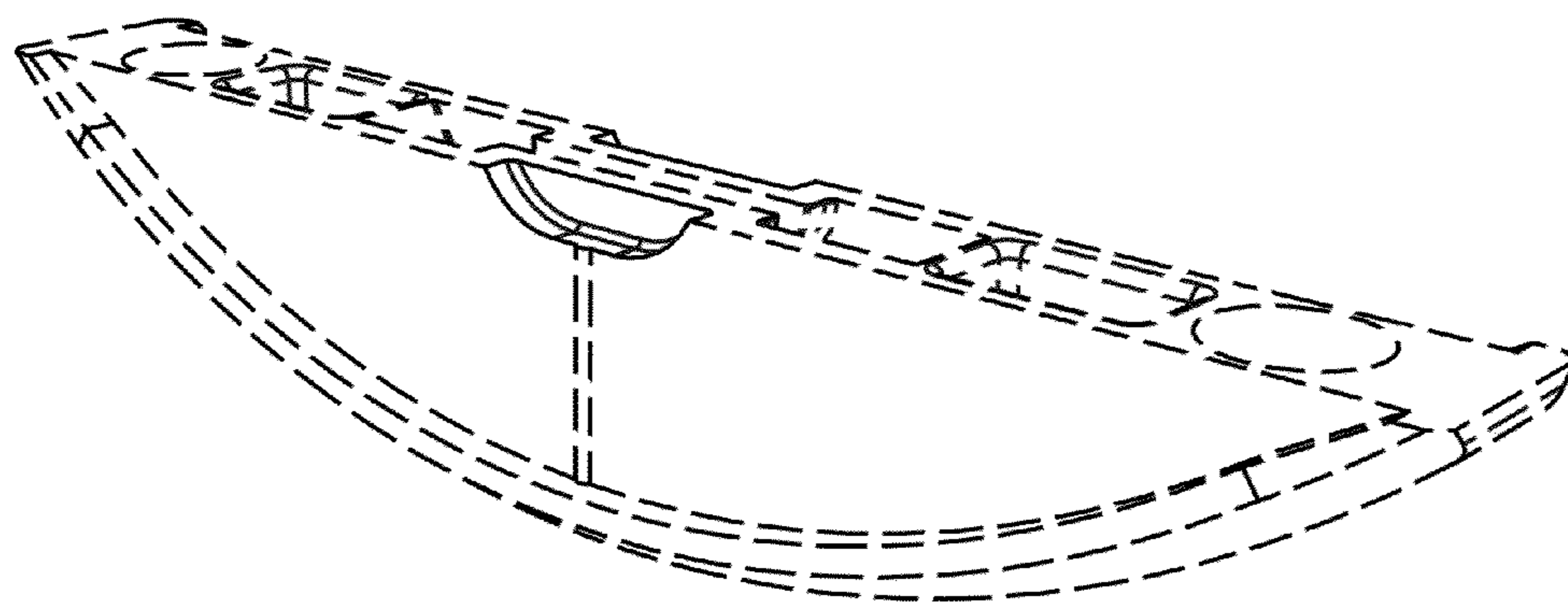

FIG. 29

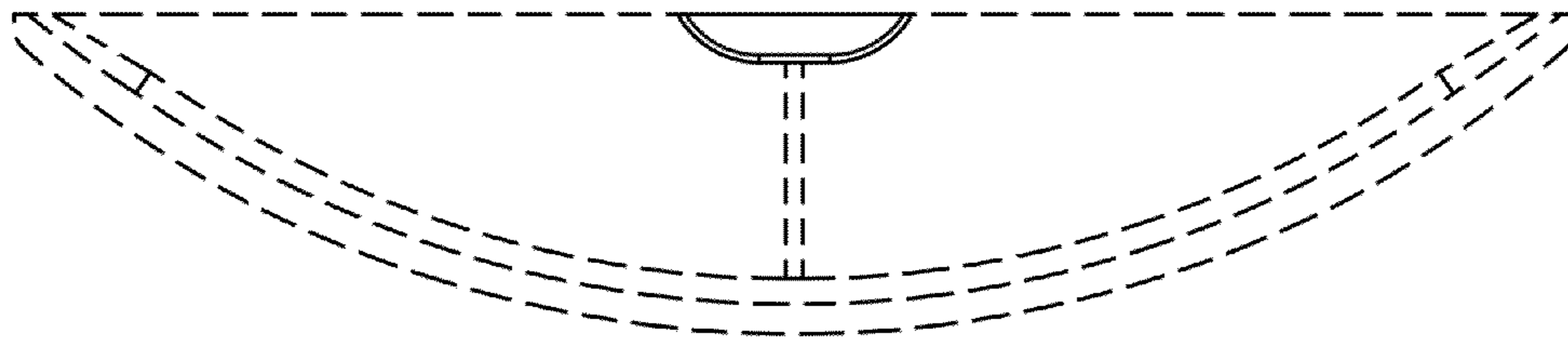

FIG. 30





FIG. 31

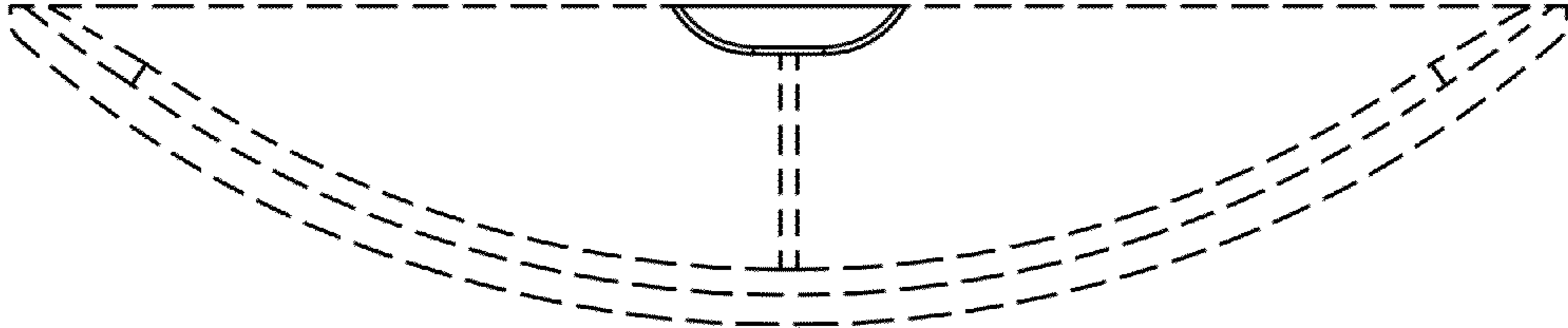

FIG. 32



FIG. 33

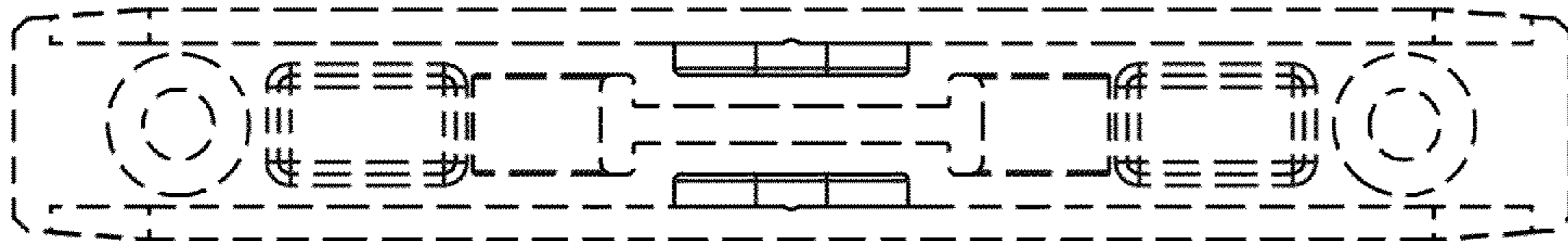

FIG. 34

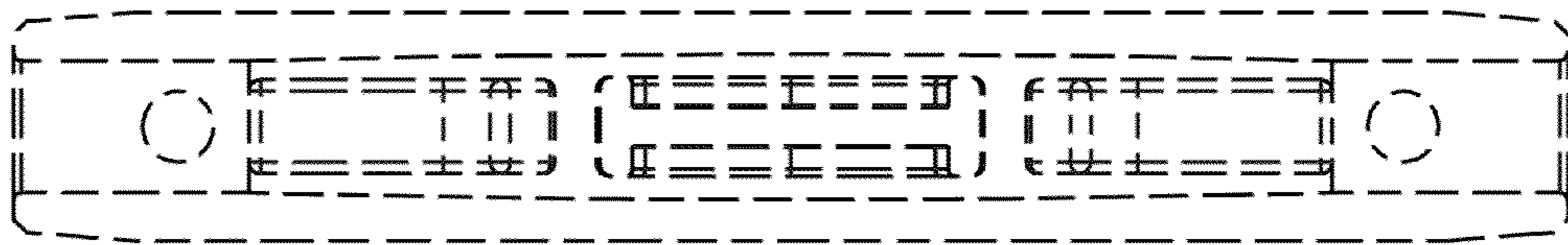

FIG. 35

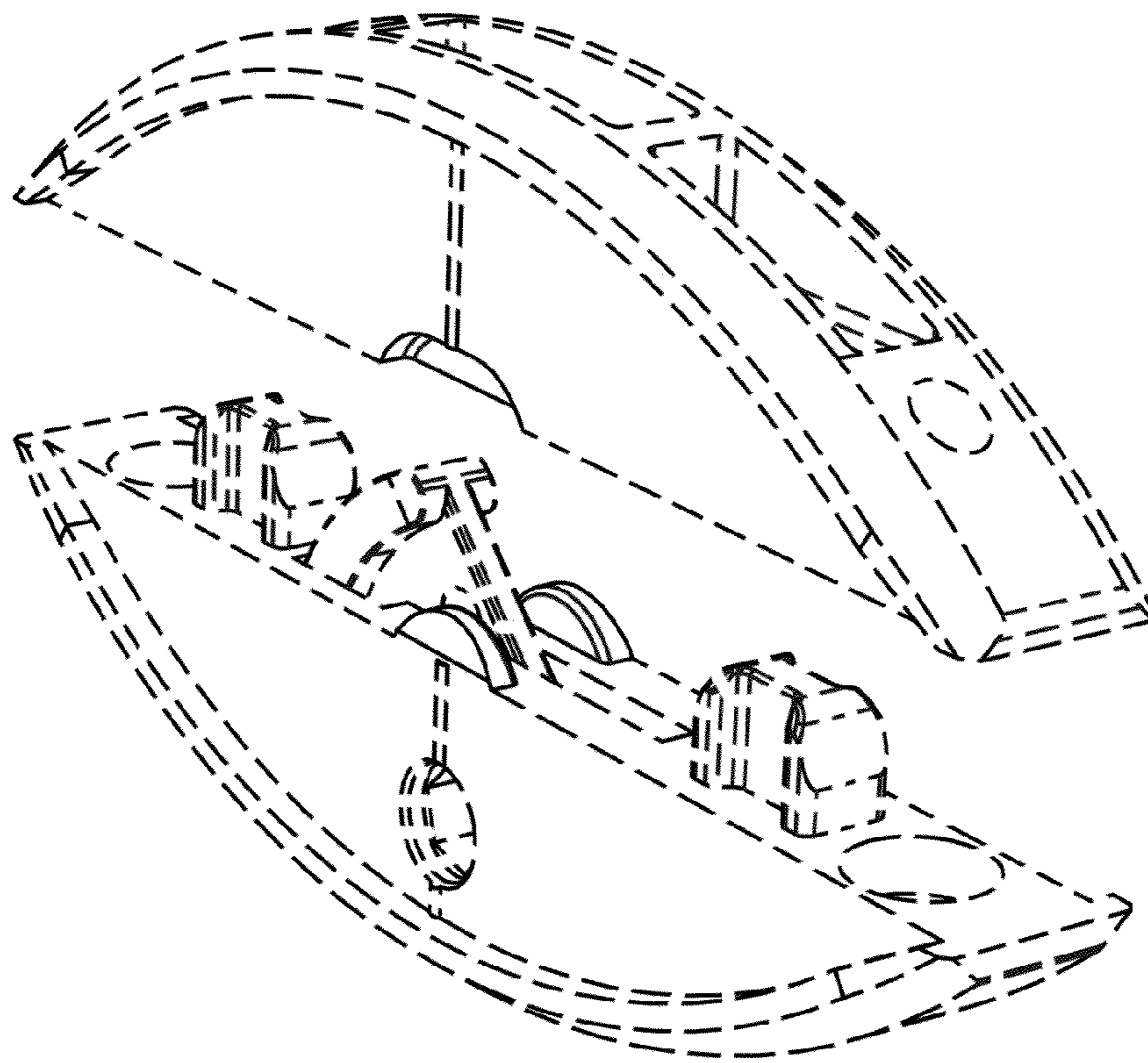

FIG. 36

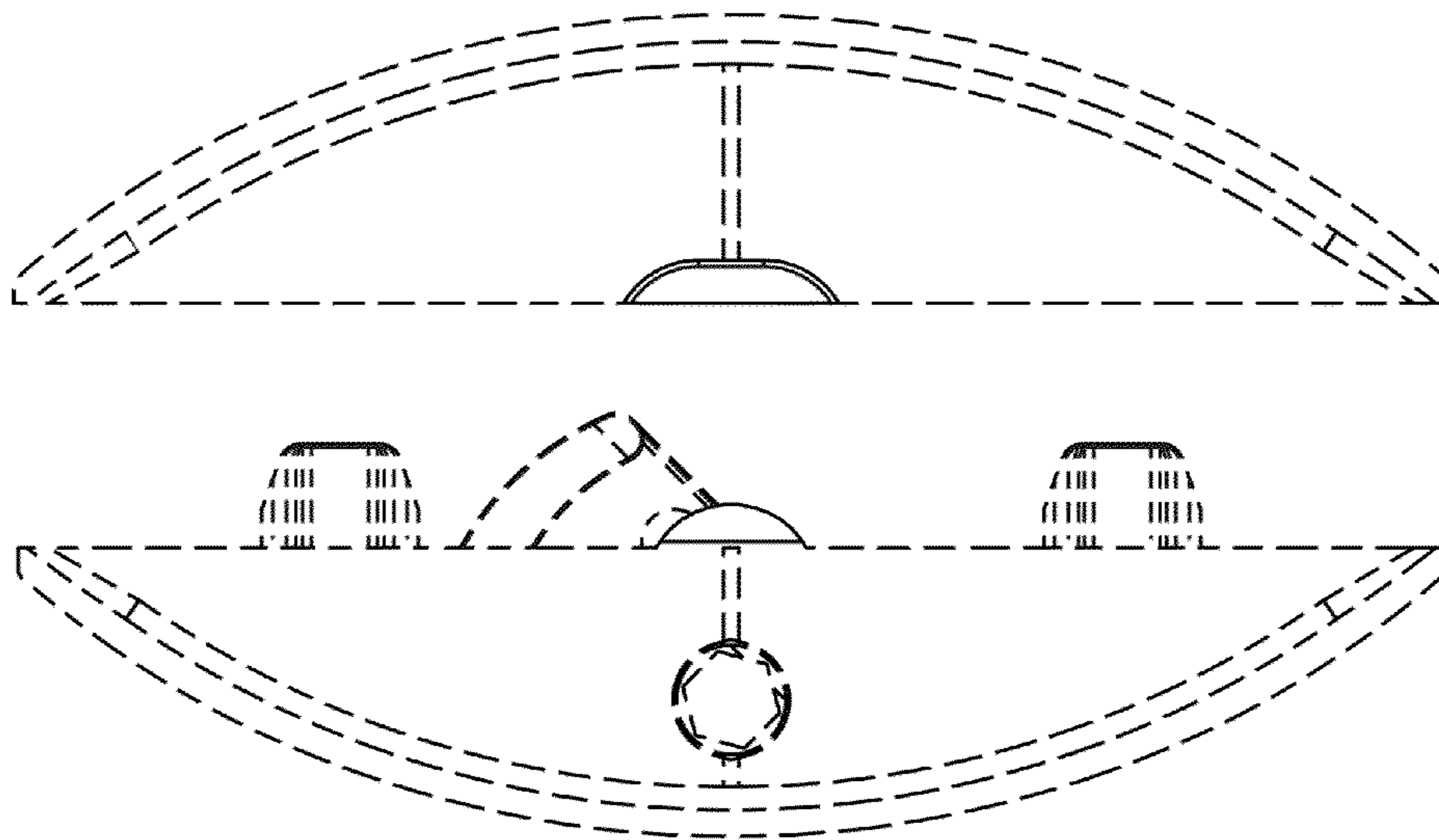

FIG. 37

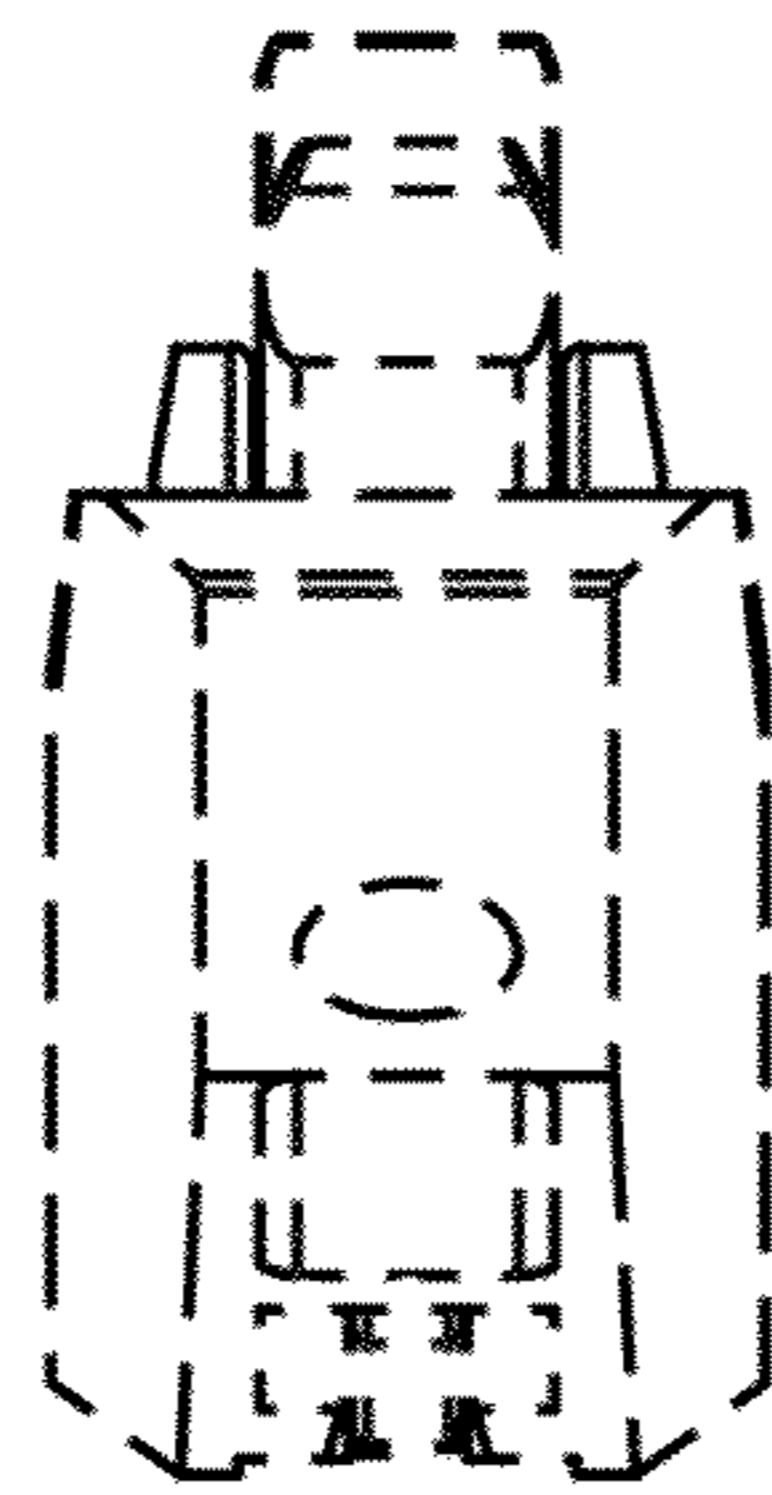
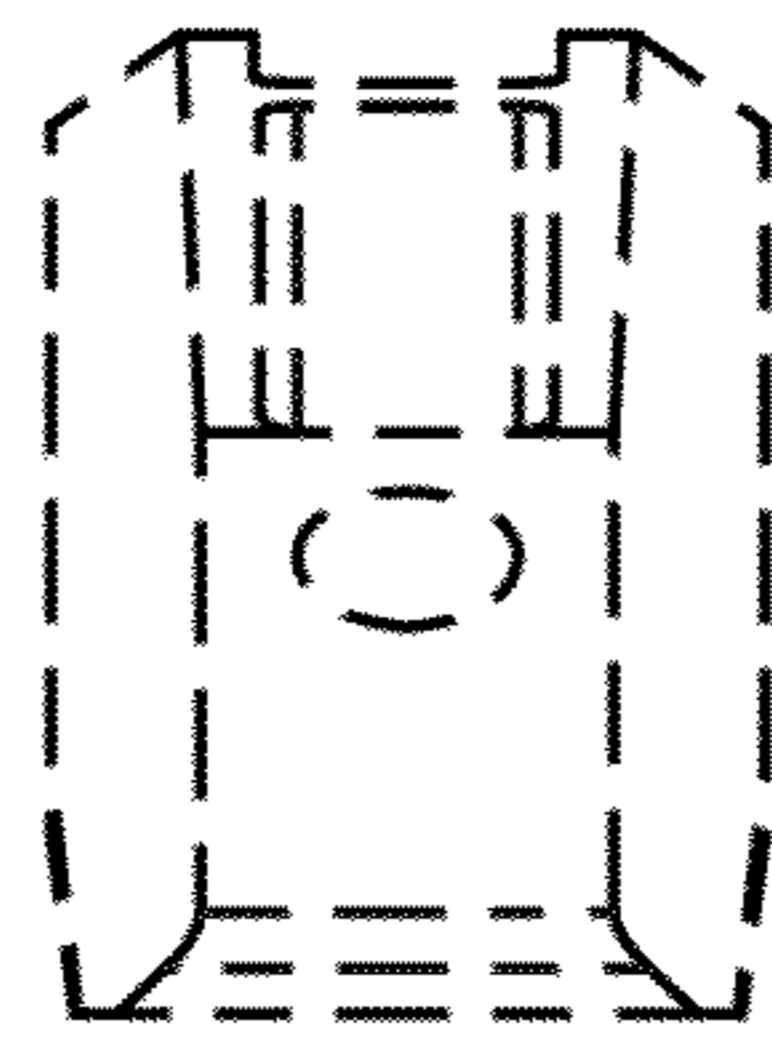

FIG. 38



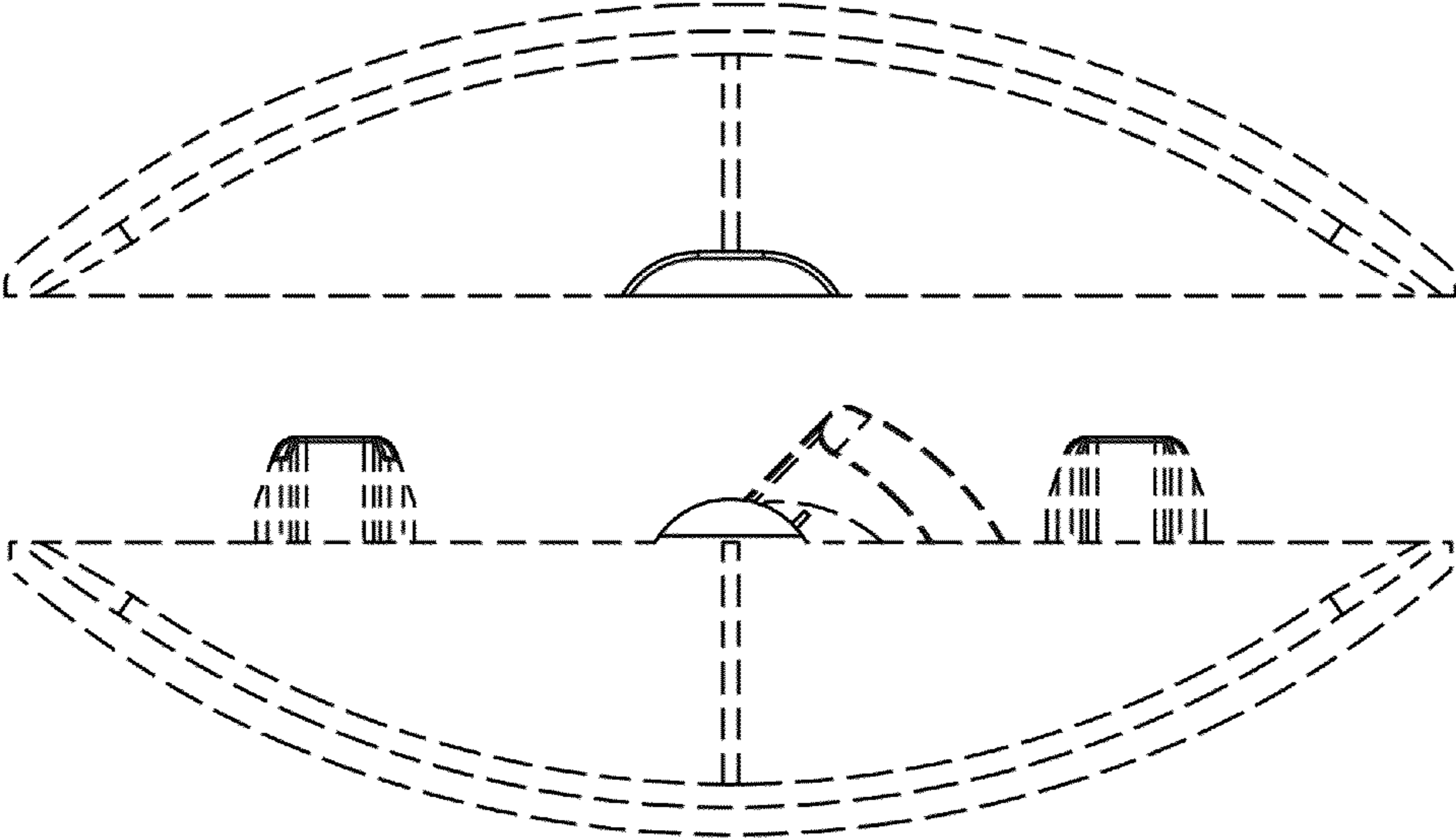

FIG. 39

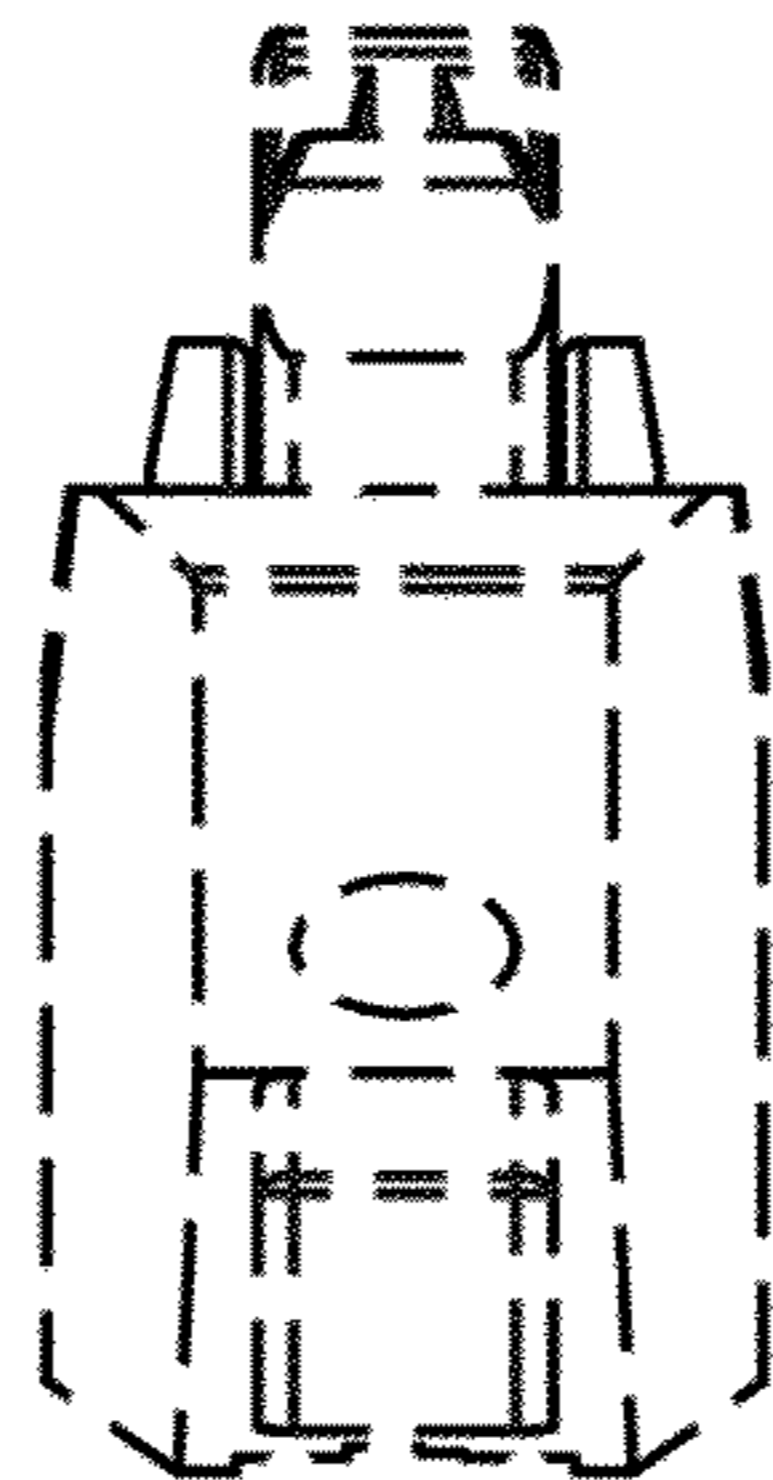
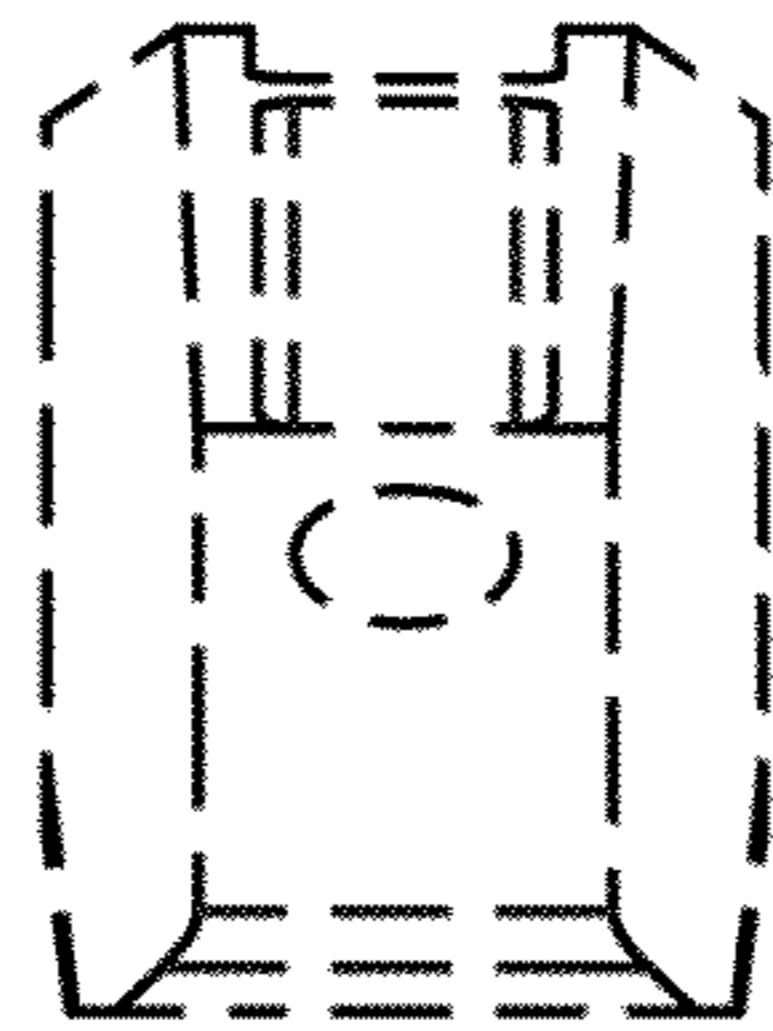

FIG. 40

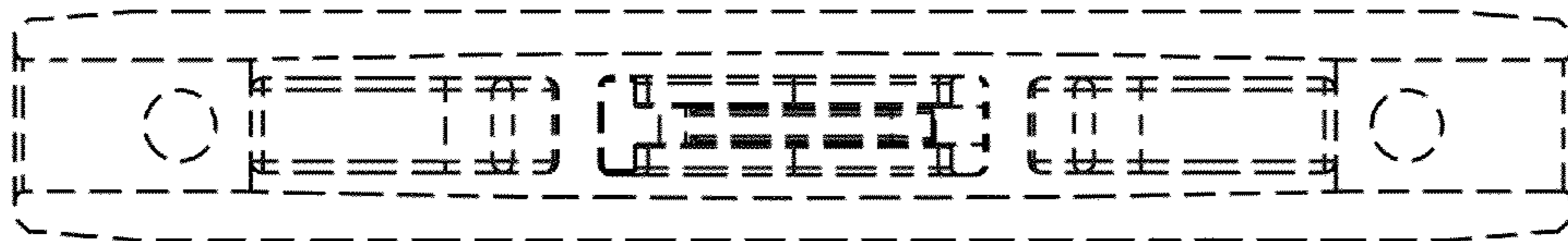

FIG. 41

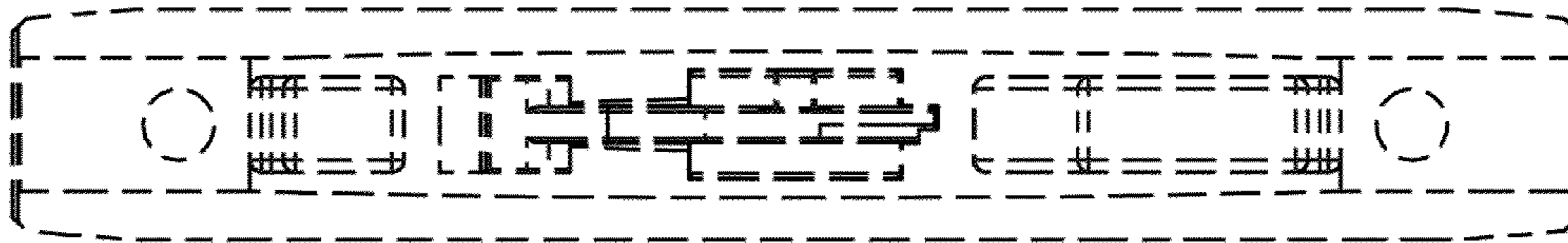

FIG. 42